

PICMG 1.3 Passive Backplane

Selection Guide

PAC series wall-mount chassis

4U/5U rack-mount chassis

1U/2U rack-mount chassis

PICMG 1.3 (PCIe+PCI)	Model	PE-2SD1	PE-2SD2	PE-4S	PE-4S2	PE-4S3	PE-5S	PE-5S2	PE-6S	PE-6S2	PE-6SD	PE-6SD2	PE-6SD3
Total Slot		2	2	4	4	4	5	5	6	6	5	5	5
Expansion Slots	PCIe Slots	x16 *	1		1	1	1	1	1	1	1	1	1
		x4			1								
		x1					2		3	2		3	2
	PCI-X Slots												
PCI Slots		1	1	2		2		2	3			1	2
USB Connectors by Pin Header		4	4	4	4	4	4	4	4	4	4	4	4
PSU Type		24+4-pin ATX	24+4-pin ATX	24+4-pin ATX	24+4-pin ATX	24+4-pin ATX	24+4-pin ATX	24+4-pin ATX	24+4-pin ATX	24+4-pin ATX	24+4-pin ATX	24+4-pin ATX	24+4-pin ATX
Chassis		RACK-1150-PE RACP-1151-PE	RACK-1150-PE RACP-1151-PE	N/A	N/A	N/A	RACK-500G	RACK-500G	RACK-305G RACK-360G RACK-3000G PAC-1700G PAC-125	PAC-106G x 1 PAC-107G x 1 PAC-1000G	N/A	N/A	N/A
Note		1U Type	1U Type								2U Type	2U Type	2U Type

PICMG 1.3 (PCIe+PCI)	Model	PE-7S	PE-7S2	PE-8S	PE-9S	PE-10S	PE-10S2	PE-13SD	PXE-9S2	PXE-12S	PXE-13S	PXE-19S	PXE-19S2
Total Slot		7	7	8	9	10	10	13	9	12	13	19	19
Expansion Slots	PCIe Slots	x16 *	1	1	1	1	1	1/1	1	1	1	1	1
		x4						1/0	3				
		x1	2	4	3	4	4	4	0/4	0		3	1
	PCI-X Slots								0	6			
PCI Slots		3	1	3	3	4	4	2/2	4	4	8	16	16
USB Connectors by Pin Header		4	4	4	4	4	4	8	4	4	4	4	4
PSU Type		24+4-pin ATX	24+4-pin ATX	24+4-pin ATX	24+4-pin ATX	24+4-pin ATX	24+4-pin ATX	Dual 24+4-pin ATX	24+4-pin ATX	24+4-pin ATX	24+4-pin ATX	24+4-pin ATX	24+4-pin ATX
Chassis		PAC-1700G	PAC-1700G	PAC-125G	N/A	RACK-305G RACK-360G RACK-3000G	RACK-3000G RACK-305G RACK-360G	RACK-3000G RACK-305G RACK-360G	RACK-3000G RACK-305G RACK-360G	RACK-3000G RACK-305G RACK-360G	RACK-3000G RACK-305G RACK-360G	N/A	N/A
Note								Dual System Backplane	PCIe to PCIe switch Backplane	PCIe to PCI-X Bridge Backplane	PCIe to PCI Bridge Backplane		

*When using a PCIe x16 add-on card, the length of the card must not exceed 167mm or 6.57 inches.

IEI Graphics Grade Backplane Solution

The graphics grade backplane solution targets the applications which concern system speed and performance. It has higher performance over cost ratio than the previous PICMG 1.0 solution.

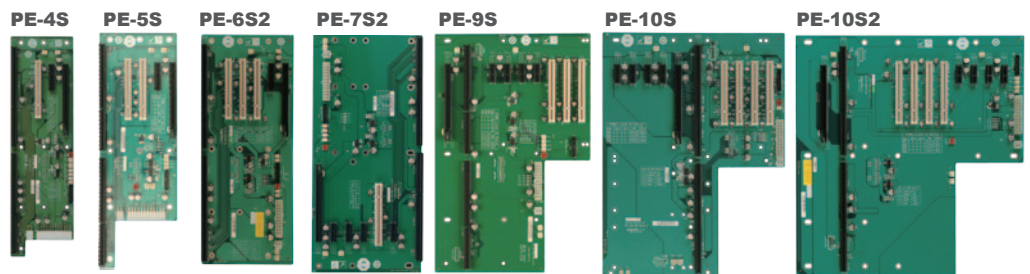
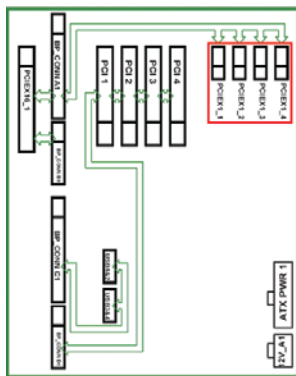

- Twenty PCIe lanes total
- One PCIe x16 slot
- Up to four PCIe x1 or one PCIe x4 slot
- Up to four local PCI slots (w/o bridge)

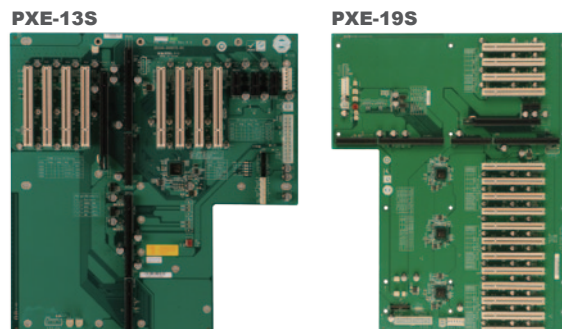
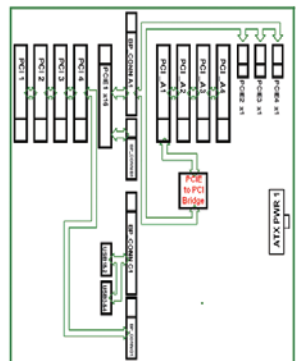

- Twenty PCIe lanes total
- One PCIe x16 slot
- Up to four PCIe x1 slots
- PCI slots expandable via PCIe to PCI bridge

PE-2SD1-R10

For 1U system!

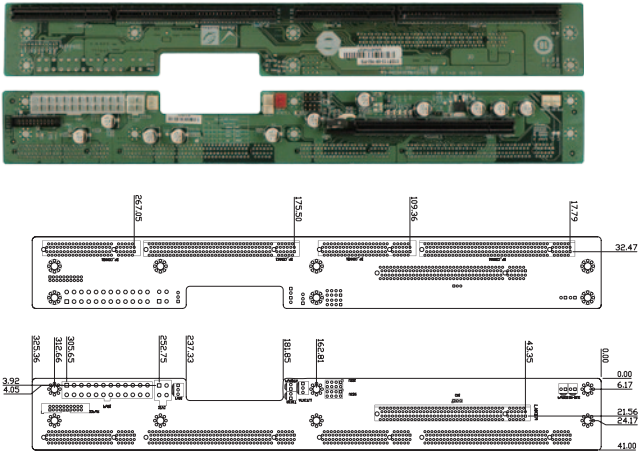

Ordering Information

PE-2SD1-R10 2-slot backplane with one PCIe slot
 RACK-1150G-PE 1U full-size rack-mount chassis

PE-2SD2-R10

For 1U system!

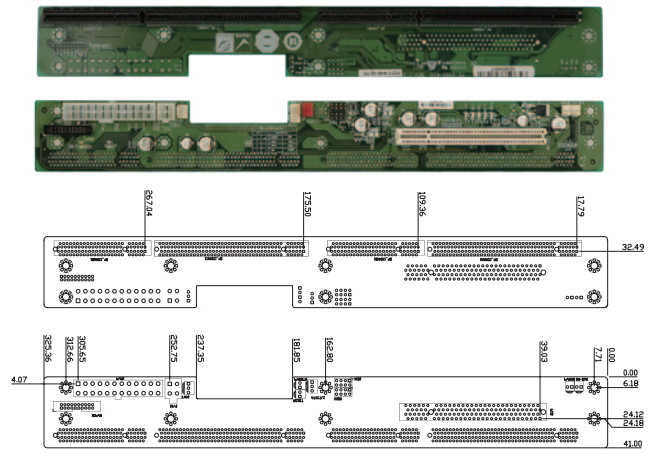

Ordering Information

PE-2SD2-R10 2-slot backplane with one PCI slot
 RACK-1150G-PE 1U full-size rack-mount chassis

PE-4S-R40

Mounting holes compatible with PCI-4S

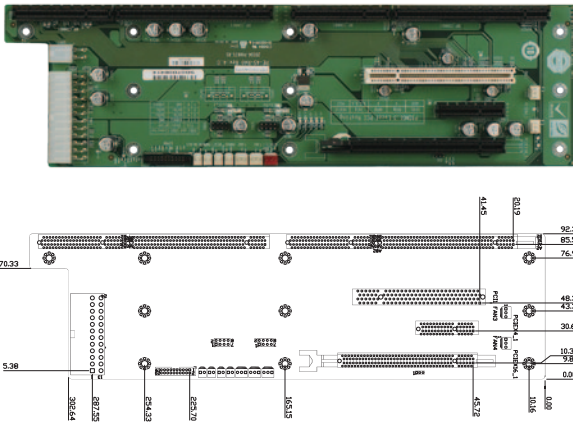

Ordering Information

PE-4S-R40 4-slot backplane with one PCIe x16 slot, one PCIe x4 slot and one PCI slot

PE-4S2-R40

Mounting holes compatible with PCI-4S

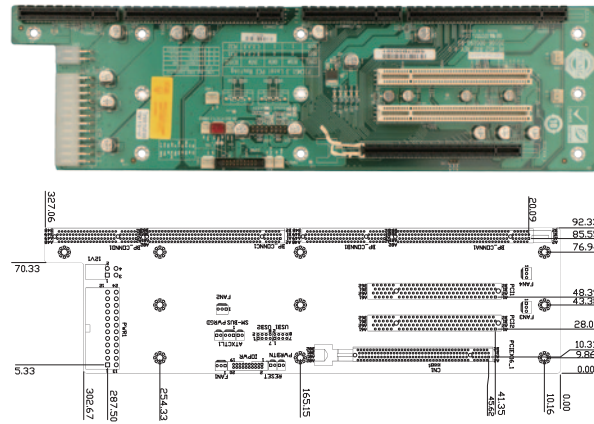

Ordering Information

PE-4S2-R40 4-slot backplane with one PCIe x16 slot and two PCI slots

PE-4S3-R40

Mounting holes compatible with PCI-4S

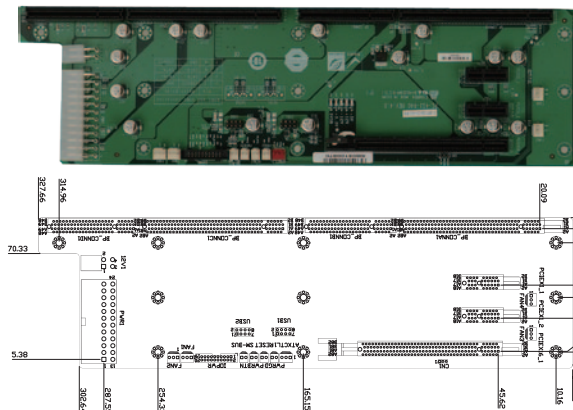

Ordering Information

PE-4S3-R40 4-slot backplane with one PCIe x16 slot and two PCIe x1 slots

PE-5S-R40

Mounting holes compatible with PCI-5S

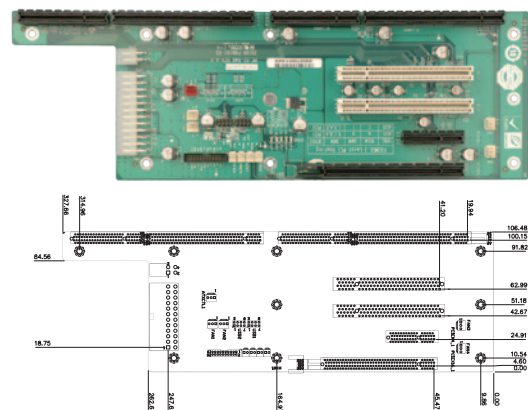

Ordering Information

PE-5S-R40 5-slot backplane with one PCIe x16 slot, one PCIe x4 slot and two PCI slots
 RACK-500G 5U 5-slot full-size rack-mount chassis

PE-5S2-R40

Mounting holes compatible with PCI-5S

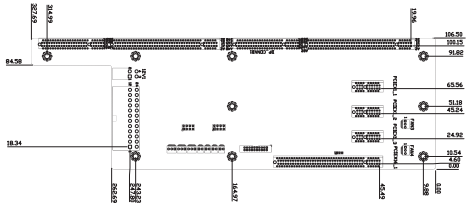
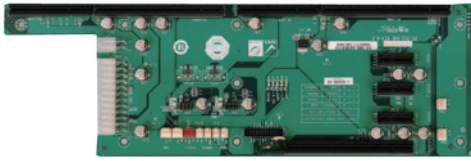

Ordering Information

PE-5S2-R40	5-slot backplane with one PCIe x16 slot and three PCIe x1 slots
RACK-500G	5U 5-slot full-size rack-mount chassis

PE-6S2-R40

Mounting holes compatible with PCI-6S

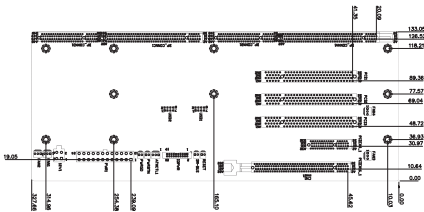
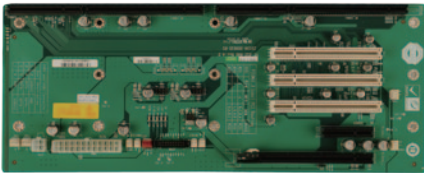

Ordering Information

PE-6S2-R40	6-slot backplane with one PCIe x16 slot, one PCIe x4 slot and three PCI slots
PAC-106G *	6-slot full-size compact chassis
PAC-107G *	6-slot full-size compact chassis
PAC-1000G	6-slot full-size compact chassis

* When using a PCIe x16 add-on card, the length of the card must not exceed 167mm or 6.57 inches.

PE-6SD2-R40

Mounting holes compatible with PCI-6SD

2U Type

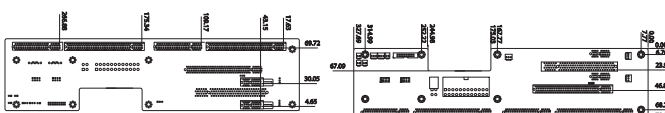
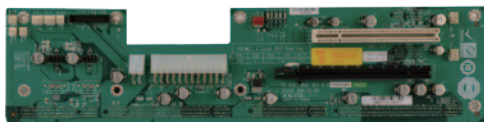
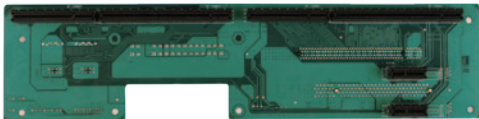

Ordering Information

PE-6SD2-R40	5-slot backplane with one PCIe x16 slot, two PCIe x1 slots and one PCI slot
-------------	-----------------------------------------------------------------------------

PE-6S-R41

Mounting holes compatible with PCI-7S

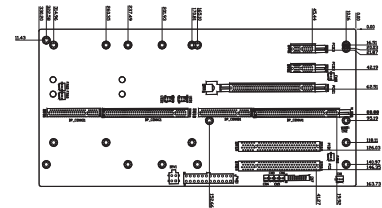
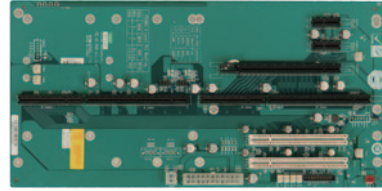

Ordering Information

PE-6S-R41	6-slot backplane with one PCIe x16 slot, two PCIe x1 slots and two PCI slots
RACK-305G	4U 14-slot full-size rack-mount chassis
RACK-360G	4U 14-slot full-size rack-mount chassis
RACK-3000G	4U 14-slot full-size rack-mount chassis
PAC-1700G	7-slot full-size compact chassis
PAC-125G	10-slot full-size compact chassis

PE-6SD-R40

Mounting holes compatible with PCI-6SD

2U Type

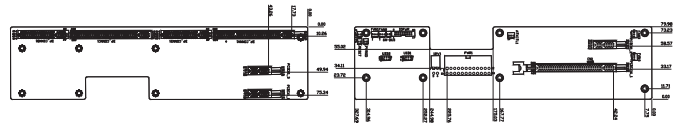
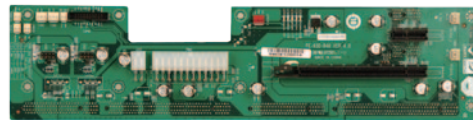
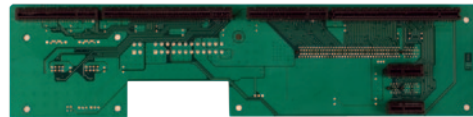

Ordering Information

PE-6SD-R40	5-slot backplane with one PCIe x16 slot and three PCIe x1 slots
------------	-----------------------------------------------------------------

PE-6SD3-R40

Mounting holes compatible with PCI-6SD

2U Type

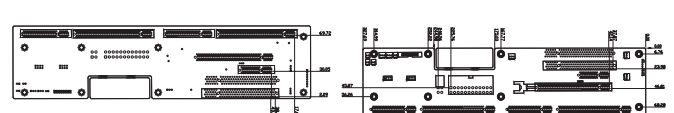
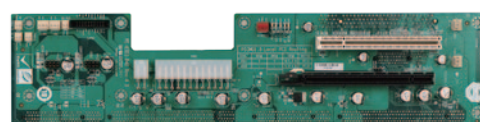
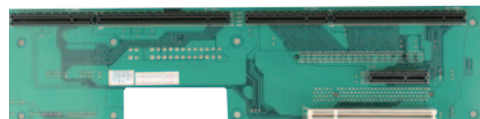

Ordering Information

PE-6SD3-R40	5-slot backplane with one PCIe x16 slot, one PCIe x4 slot and two PCI slots
-------------	-----------------------------------------------------------------------------

PE-7S-R40

Mounting holes compatible with PCI-7S

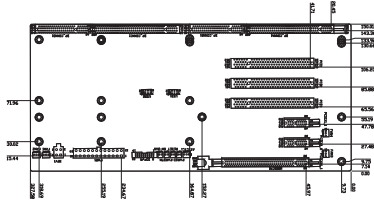
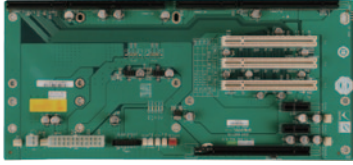

Ordering Information

PE-7S-R40	7-slot backplane with one PCIe x16 slot, two PCIe x1 slots and three PCI slots
PAC-1700G	7-slot full-size compact chassis

PE-7S2-R40

Mounting holes compatible with PCI-7S

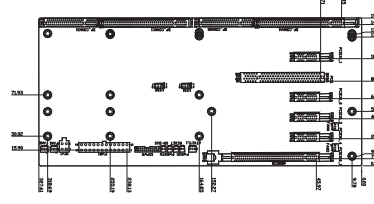
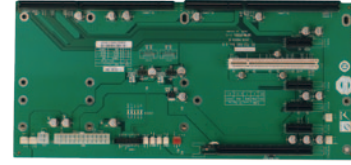

Ordering Information

PE-7S2-R40	7-slot backplane with one PCIe x16 slot, four PCIe x1 slots and one PCI slot
PAC-1700G	7-slot full-size compact chassis

PE-8S-R40

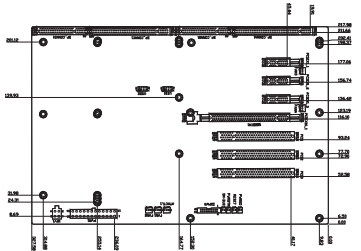
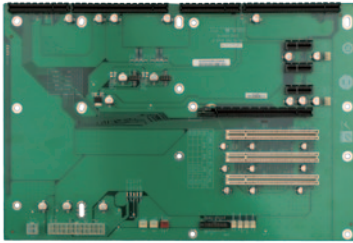

Ordering Information

PE-8S-R40	8-slot backplane with one PCIe x16 slots, three PCIe x1 slots and three PCI slots
PAC-125G	10-slot full-size compact chassis

PE-9S-R40

Mounting holes compatible with PCI-10S2

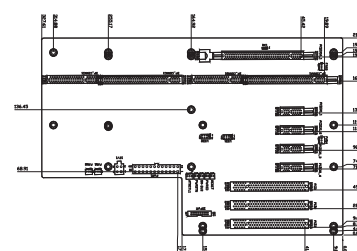
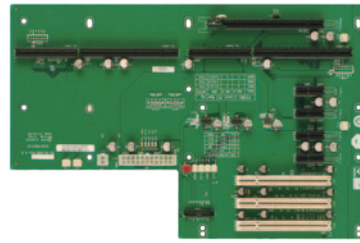

Ordering Information

PE-9S-R40	9-slot backplane with one PCIe x16 slot, four PCIe x1 slots and three PCI slots
-----------	---------------------------------------------------------------------------------

PE-10S-R40

Mounting holes compatible with PCI-14S

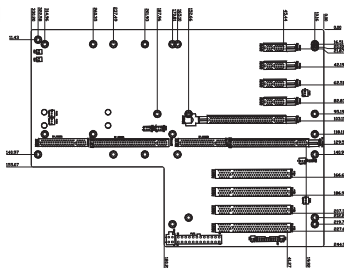
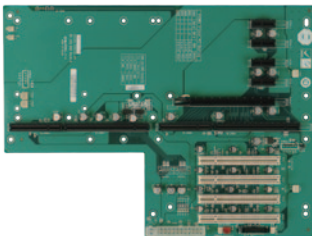

Ordering Information

PE-10S-R40	10-slot backplane with one PCIe x16 slot, four PCIe x1 slots and four PCI slots
RACK-305G	4U 14-slot full-size rack-mount chassis
RACK-360G	4U 14-slot full-size rack-mount chassis
RACK-3000G	4U 14-slot full-size rack-mount chassis

PE-10S2-R40

Mounting holes compatible with PCI-14S

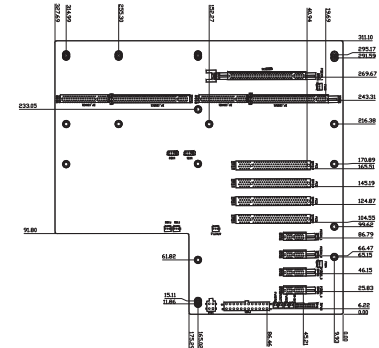
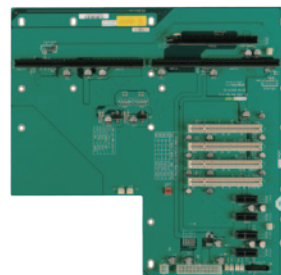

Ordering Information

PE-10S2-R40	10-slot backplane with one PCIe x16 slot, four PCIe x1 slots and four PCI slots
RACK-3000G	4U 14-slot full-size rack-mount chassis
RACK-305G	4U 14-slot full-size rack-mount chassis
RACK-360G	4U 14-slot full-size rack-mount chassis

PE-13SD-R40 Mounting holes compatible with PCI-14S

Dual system

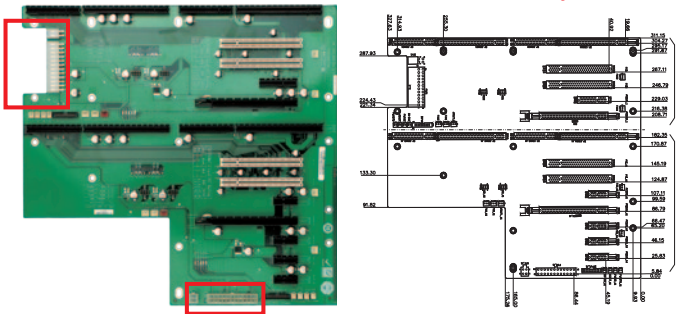

2 independent power resources

Ordering Information

PE-13SD-R40	13-slot backplane with two PCIe x16 and one PCIe x4 and four PCIe x1 and four PCI slot
RACK-3000G	4U 14-slot full-size rack-mount chassis
RACK-305G	4U 14-slot full-size rack-mount chassis
RACK-360G	4U 14-slot full-size rack-mount chassis

PXE-9S2-R10 Mounting holes compatible with PCI-14S

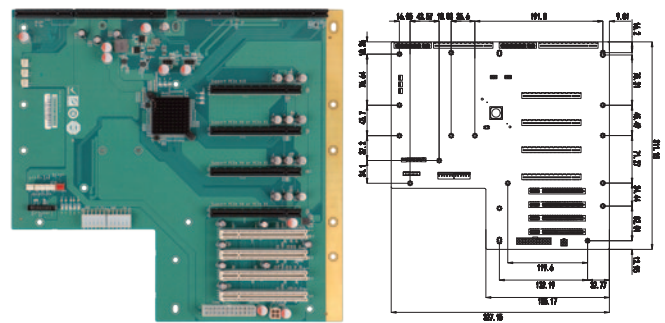

Ordering Information

PXE-9S2-R10	9-slot PICMG 1.3 backplane, 1 PCIe x16 w/ x16 slots, 3 PCIe x4 w/ x16 slots, 4 PCI, RoHS
RACK-305G	4U 14-slot full-size rack-mount chassis
RACK-360G	4U 14-slot full-size rack-mount chassis
RACK-3000G	4U 14-slot full-size rack-mount chassis

PXE-12S-R10 Mounting holes compatible with PCI-14S

(PCIe to PCI-X Bridge)

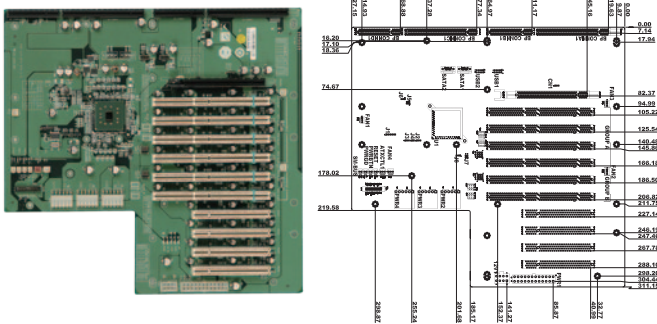

Ordering Information

PXE-12S-R10	12-slot backplane with one PCIe x16 slot, six PCI-X slots and four PCI slots
RACK-3000G	4U 14-slot full-size rack-mount chassis
RACK-305G	4U 14-slot full-size rack-mount chassis
RACK-360G	4U 14-slot full-size rack-mount chassis

PXE-13S-R50 Mounting holes compatible with PCI-14S

(PCIe to PCI Bridge)

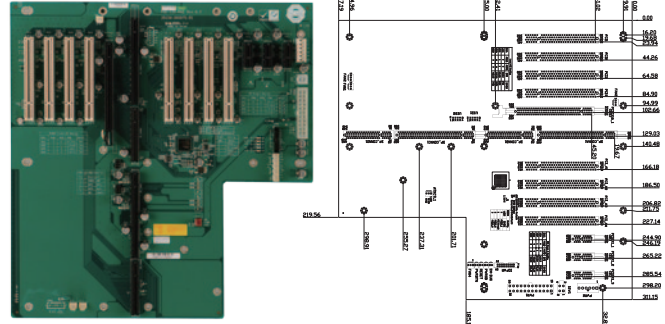

Ordering Information

PXE-13S-R50	13-slot backplane with one PCIe x16 slot, three PCIe x1 slots and eight PCI slots
RACK-3000G	4U 14-slot full-size rack-mount chassis
RACK-305G	4U 14-slot full-size rack-mount chassis
RACK-360G	4U 14-slot full-size rack-mount chassis

PXE-19S-R40 Mounting holes compatible with PCI-19S

(PCIe to PCI Bridge)

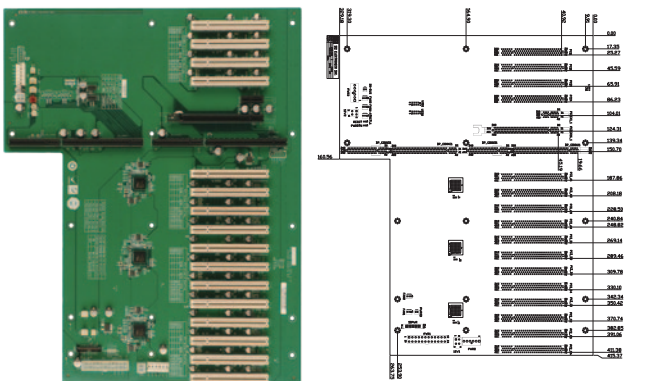

Ordering Information

PXE-19S-R40	19-slot backplane with one PCIe x16 slot, one PCIe x1 slot and sixteen PCI slots
-------------	----------------------------------------------------------------------------------

PXE-19S2-R10 Mounting holes compatible with PCI-19S

(PCIe to PCI Bridge)

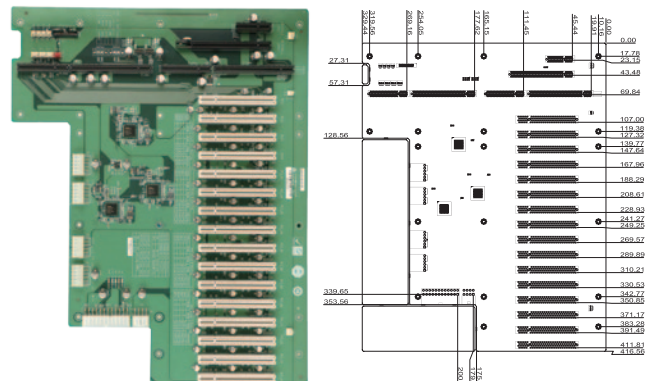

Ordering Information

PXE-19S2-R10	19-slot backplane with one PCIe x16 slot, one PCIe x1 slot and sixteen PCI slots
--------------	----------------------------------------------------------------------------------

X-ON Electronics

Largest Supplier of Electrical and Electronic Components

Click to view similar products for [Interface Modules](#) category:

Click to view products by [IEI](#) manufacturer:

Other Similar products are found below :

[IFD8520](#) [cPCI-3544](#) [422CON](#) [ATX6022/14GP7](#) [ATX6022/8](#) [AX93221-24/48](#) [FC6A-EXM2](#) [OPT8AP-AE](#) [96RMKVM-19V1C-A](#) [60016-011](#) [60016-014](#) [60006-008](#) [60011-075](#) [HPCI-14S12U](#) [cBP-3208](#) [cBP-3062A](#) [FAB205-6P5](#) [ATX6022/6](#) [60016-012](#) [96RMKVM-17V1C-A](#) [PCE-DP10-00A1E](#) [MOS-1120Y-0201E](#) [96RMLCD-17V1-A](#) [96RMKVM-17V8C-A](#) [60004-005](#) [60016-017](#) [60006-009](#) [60016-035](#) [60016-034](#) [60016-031](#) [60016-030](#) [60016-026](#) [60016-024](#) [60016-018](#) [60016-007](#) [60016-005](#) [60007-002](#) [60006-010](#) [AXX10GBTWLHW3](#) [382-BBEH](#) [555-BDCL](#) [K6CMISZBI52](#) [426451401-3](#) [60011-093](#) [MIC-3620/3-BE](#) [MPCIE-UART-KIT02-R20](#) [RSM232](#) [PCIE-1680-AE](#) [BB-FOSTCDRI](#) [73-544-002](#)