

1400
1500

E2/000 | e-chains® 1400·1500 | Product range

Small radii, high strength

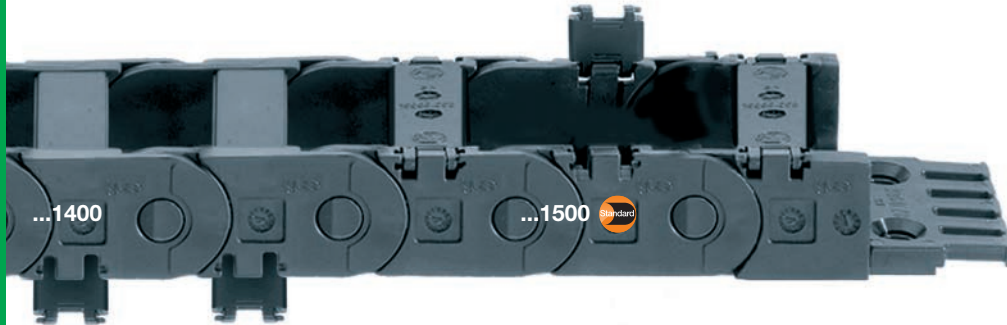
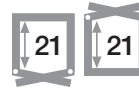

e-chains® | 1400 snap-open along inner radius from both sides

e-chains® | 1500 snap-open along outer radius from both sides | Standard

e-chains® snap-open along the inner radius	e-chains® snap-open along the outer radius	 Bi [mm]	Ba [mm]	R Bend radii [mm]	1400 [kg/m]	1500 [kg/m]
1400.015.R.0	1500.015.R.0 ¹⁾	15	28,5	035 038 048 075 100 125 145 180	≈ 0,46	≈ 0,46
1400.020.R.0	1500.020.R.0 ¹⁾	20	33,5	035 038 048 075 100 125 145 180	≈ 0,47	≈ 0,47
1400.025.R.0	1500.025.R.0 ¹⁾	25	38,5	035 038 048 075 100 125 145 180	≈ 0,49	≈ 0,49
1400.038.R.0	1500.038.R.0 ¹⁾	38	51,5	035 038 048 075 100 125 145 180	≈ 0,53	≈ 0,53
1400.050.R.0	1500.050.R.0 ¹⁾	50	63,5	035 038 048 075 100 125 145 180	≈ 0,56	≈ 0,56
1400.068.R.0	1500.068.R.0 ¹⁾	68	81,5	035 038 048 075 100 125 145 180	≈ 0,63	≈ 0,63
1400.080.R.0	1500.080.R.0 ¹⁾	80	93,5	035 038 048 075 100 125 145 180	≈ 0,67	≈ 0,67
1400.100.R.0	1500.100.R.0	100	113,5	035 038 048 075 100 125 145 180	≈ 0,74	≈ 0,74
1400.125.R.0	1500.125.R.0	125	138,5	035 038 048 075 100 125 145 180	≈ 0,83	≈ 0,83

1)  ESD/ATEX version available from stock

Half e-tubes, series 1450 and full e-tube series 1480 ► from page 280

Supplement Part No. with required radius (R). Example: 1500.038.100.0



ESD/ATEX permanently conductive e-chains® - 1500 several widths with delivery from stock:
inner widths **Bi** 15 - 80, radii **R** 038 - 145. Full ESD product range ► www.igus.eu/ESD

Open e-chains® in a flash with the igus® e-chain® opener

Reduce assembly time from 33 to 2 sec. with the igus® e-chain® opener. Open a long piece of e-chain® in one go. Part No. 908.254.1400 for series 1400/1500.
For widths **Bi** [mm]: 20, 50, 68, 80, 100.

More information ► www.igus.eu/savetime



274 More information ► www.igus.eu/1400 ► www.igus.eu/1500

E2/000 | e-chains® 1400-1500 | Dimensions



1400
1500

Unsupported applications | Short travels

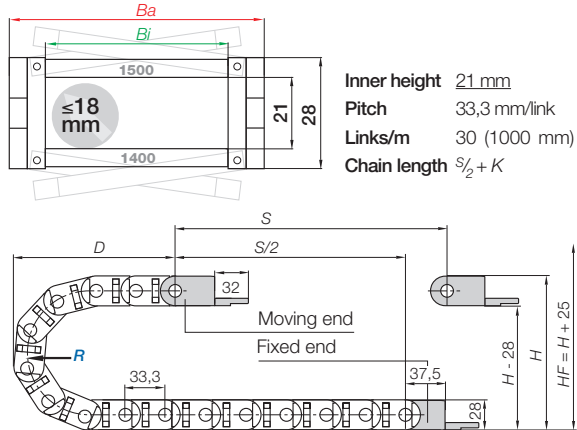
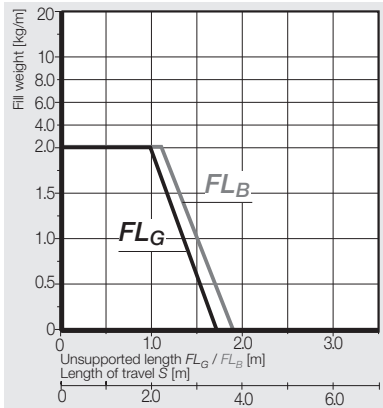

R	035	038	048	075	100	125	145	180
H	98	104	124	178	228	278	318	388
D	99	102	112	139	164	189	209	244
K	180	190	220	305	385	460	525	635

The required clearance height: $H_F = H + 25\text{ mm}$ (with 0,5 kg/m fill weight)

Before using series 1400 on long travels please consult igus®.

Gliding applications | Long travels from 10 m to max. 75 m

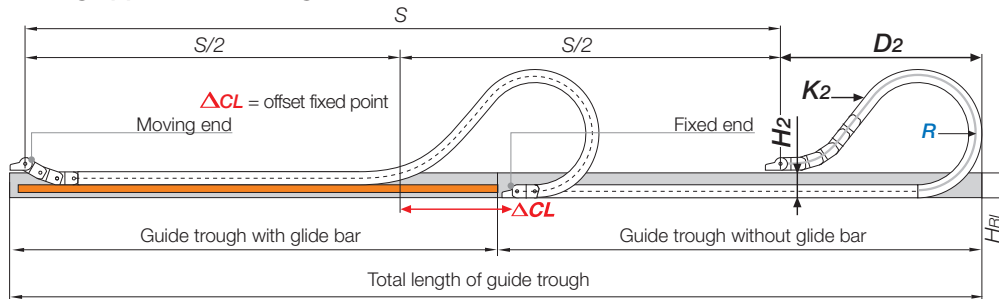

Note: for long travel (gliding) applications, please consult igus®.

For long travels, igus® specifies series 1500 that snaps open along the outer radius.

In case of travels between 4 and 10 m we recommend a longer ununsupported length. Chain length $S/2 + K_2$

R	035	038	048	075	100	125	145	180
H_2	70	76	96	150	100	100	100	100
D_2^{+25}	99	102	112	139	340	495	540	690
K_2	180	190	220	305	600	800	940	1170
ΔACL	-	-	-	-	179	305	340	445

Before using series 1400 on long travels please consult igus®.

1400
1500

E2/000 | e-chains® 1400-1500 | Accessories

Mounting brackets, polymer | Pivoting | Locking

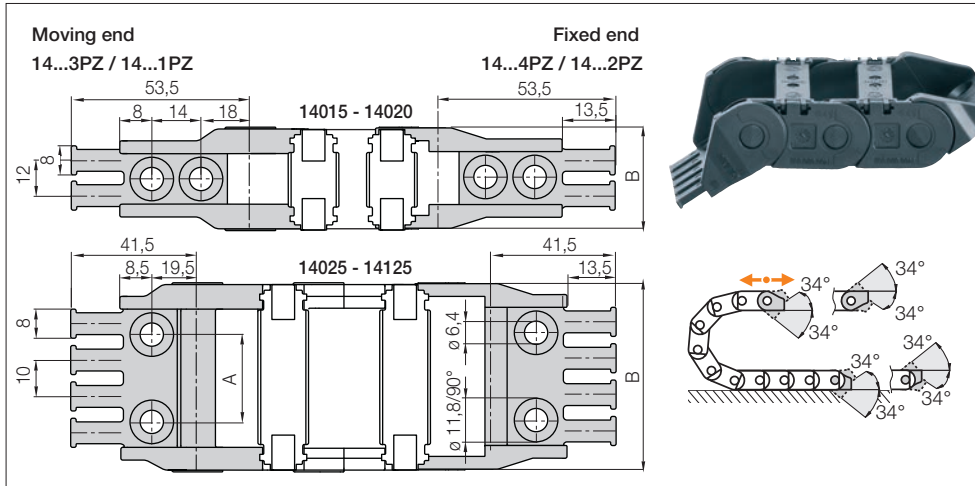

Polymer pivoting | Recommended for unsupported and gliding applications | **Standard Polymer locking** | Recommended for vertical hanging and standing applications

Width Index	Part No. full set pivoting with tiewrap plates	Part No. full set locking with tiewrap plates	A [mm]	B [mm]	Number of teeth
.015. ▶	14015.34PZ	14015.12PZ	-	28,5	2
.020. ▶	14020.34PZ	14020.12PZ	-	33,5	2
.025. ▶	14025.34PZ	14025.12PZ	13	38,5	2
.038. ▶	14038.34PZ	14038.12PZ	24	51,5	4
.050. ▶	14050.34PZ	14050.12PZ	36	63,5	5
.068. ▶	14068.34PZ	14068.12PZ	54	81,5	7
.080. ▶	14080.34PZ	14080.12PZ	66	93,5	8
.100. ▶	14100.34PZ	14100.12PZ	86	113,5	10
.125. ▶	14125.34PZ	14125.12PZ	111	138,5	13

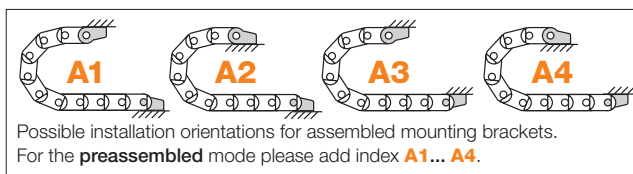

Part No. structure

14038. 34 PZ A1

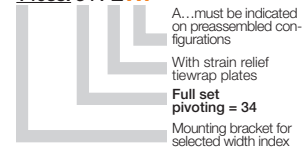

 **Strain relief** e.g. clamps, tiewrap plates, nuggets and plug-in clips are available from stock. The complete chainfix range with order options ▶ from page 656

276 More information ▶ www.igus.eu/1400 ▶ www.igus.eu/1500

E2/000 | e-chains® 1400-1500 | Accessories

Mounting brackets, polymer | Pivoting

1400
1500

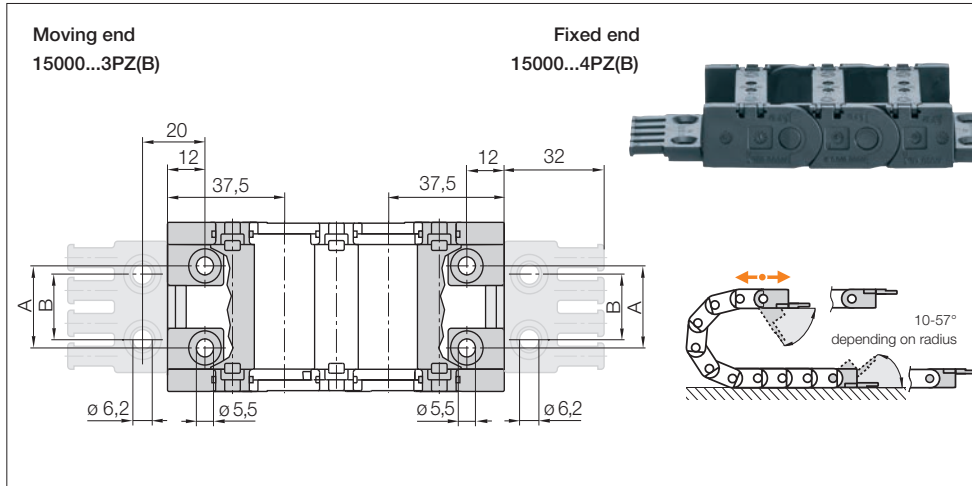

Polymer pivoting | Recommended for unsupported and gliding applications

For tight installation conditions

Width Index	Part No. full set pivoting		A [mm]	B [mm]	Number of teeth
	with tiewrap plates	without tiewrap plates			
.015.	—	—	—	—	—
.020.	—	—	—	—	—
.025.	15000.025.34PZB	15000.025.34PZ	12	15	3
.038.	15000.038.34PZB	15000.038.34PZ	25	20	4
.050.	15000.050.34PZB	15000.050.34PZ	37	30	5
.068.	15000.068.34PZB	15000.068.34PZ	55	40	6
.080.	15000.080.34PZB	15000.080.34PZ	67	60	8
.100.	15000.100.34PZB	15000.100.34PZ	87	80	10
.125.	15000.125.34PZB*	15000.125.34PZ*	112	100	12

*Tiewrap plate (consists of 2 x 2050.ZB) does not snap on but needs to be bolted down separately

Note: mounting brackets not to assemble at the gable end

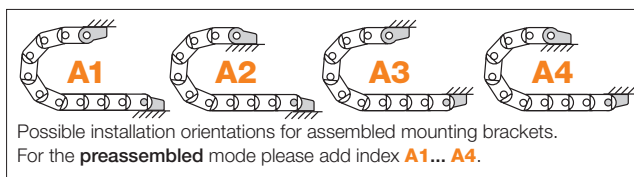

Part No. structure

15000.038.34PZA1

A... must be indicated on preassembled configurations

With strain relief tiewrap plates

Full set pivoting = 34

Mounting bracket for selected width index

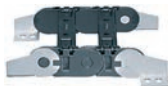

Option: steel locking Part No. 14000.12 - for e-chains® and e-tubes available

● Locked connections ● One part (2-piece) for all e-chain® widths ● Electrically conductive



Strain relief e.g. clamps, tiewrap plates, nuggets and plug-in clips are available from stock. The complete chainfix range with order options ▶ from page 656

1400
1500

E2/000 | e-chains® 1400-1500 | Accessories

Interior separation | New generation

Previous interior separation with optional elements ▶ www.igus.eu/1400 ▶ www.igus.eu/1500

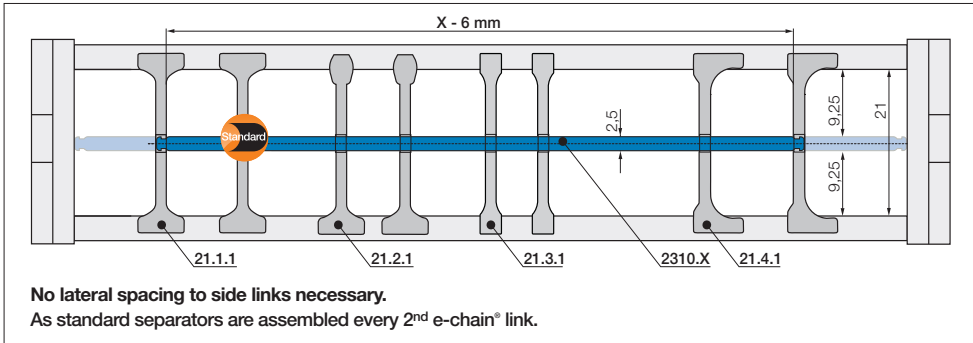

Standard separator, wide base
unassembled **21.1**
assembled **21.1.1**

Standard - for any application

Separator with a wide base for maximum holding strength in the e-chain®.

Separator, narrow head
unassembled **21.2**
assembled **21.2.1**

For even faster installation

Wide on one side for high holding strength, narrow on opposite side for easy cable fitting.

Separator, narrow base
unassembled **21.3**
assembled **21.3.1**

For thin cables

Separator with a narrow base for a large number of thin cables side by side. Saves space in e-chains®.

Separator, asymmetrical
unassembled **21.4**
assembled **21.4.1**

For side-mounted applications

Asymmetrical separator, for defined distance. No additional spacers required

Full-width shelf, lockable
unassembled **2300.X**
assembled **2310.X**

Horizontal separation

Full-width shelf locks securely into separators at both ends, giving a fixed width. Separators can be moved freely over the shelf in horizontal direction. Can be fitted at one height.

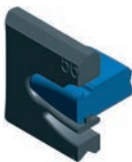

Lockable full-width shelves

Width X [mm]	unassembled	assembled	Width X [mm]	unassembled	assembled	Width X [mm]	unassembled	assembled
015	2300.015	2310.015	060	2300.060	2310.060	087	2300.87	2310.087
025	2300.025	2310.025	062	2300.062	2310.062	090	2300.90	2310.090
030	2300.030	2310.030	065	2300.065	2310.065	100	2300.100	2310.100
038	2300.038	2310.038	070	2300.070	2310.070	103	2300.103	2310.103
040	2300.040	2310.040	075	2300.075	2310.075	110	2300.110	2310.110
050	2300.050	2310.050	077	2300.077	2310.077	120	2300.120	2310.120
057	2300.057	2310.057	080	2300.080	2310.080	125	2300.125	2310.125

E2/000 | e-chains® 1400-1500 | Further accessories

1400
1500



E2/000 series 1400 in aircraft refueling truck - telescopic crane with six sections

Separator with integrated strain relief

Strain relief separator Part No. 21.1.Z can be integrated into the mounting bracket and can be placed at any point of the e-chain®. It combines strain relief and interior separation, it can be installed on the first or last e-chain® link and is easy to assemble without any screws. **More information ► from page 676**



Optional: support tray kit - for support of the lower run

- Simple one-piece support trays according to your requirements and specification
 - Easy installation onto your machine, on profiles or wall-mount brackets
 - igus® support tray - available in 2 types and 4 options
- More information ► from page 740**

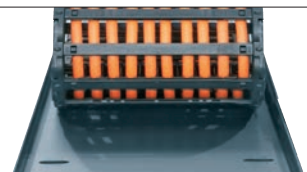

X-ON Electronics

Largest Supplier of Electrical and Electronic Components

Click to view similar products for [Cable Mounting & Accessories](#) category:

Click to view products by [Iigus](#) manufacturer:

Other Similar products are found below :

[8945](#) [8950](#) [8961](#) [582603-1](#) [CXA-0069](#) [D-150-0175CS2902](#) [70.060.1628.0](#) [770-1102](#) [770-1204](#) [770-1205-10](#) [770-1301-10](#) [770-1306](#) [770-1422](#) [770-1602](#) [770-1603](#) [770-1604](#) [770-1607](#) [790-1002](#) [809090N001](#) [843188-000](#) [843459N001](#) [8666](#) [PVC10512-BLACK-500](#) [PVC1056-BLACK-500](#) [1301800416](#) [1300830184](#) [1300830729](#) [1302000074](#) [1302261315](#) [APA18-AK](#) [MSK-0001](#) [1-787307-1](#) [1868](#) [HP-6N](#) [C-202-C](#) [CA7308-000](#) [229408-1](#) [KC-201](#) [8949](#) [8952](#) [8S23-75FR-CS8184](#) [2684](#) [9648](#) [3089](#) [A72821-000](#) [AA401](#) [173506-000](#) [1823](#) [2057](#) [2109](#)