

New in this catalog

Series E2.15 | Snap-open along outer radius from both sides | Standard

Series E2i.15 | Snap-open along inner radius from both sides

Series E2C.15 | One-piece, non snap-open e-chain®

Snap-open along outer radius	Snap-open along inner radius	One-piece, non snap-open	$B_i$ [mm]	$B_a$ [mm]	$R$ Bending radii [mm]	E2.15 [kg/m]	E2i.15 [kg/m]	E2C.15 [kg/m]	
E2.15.	E2i.15.	E2C.15.	10 .R.0	10	17,8	028   038   048   -	≈ 0,18	≈ 0,18	≈ 0,19
E2.15.	E2i.15.	E2C.15.	13 .R.0	13	20,8	028   038   048   -	≈ 0,19	≈ 0,19	≈ 0,20
E2.15.	E2i.15.	E2C.15.	16 .R.0	16	23,8	028   038   048   -	≈ 0,20	≈ 0,20	≈ 0,20
E2.15.	E2i.15.	E2C.15.	20 .R.0	20	27,8	028   038   048   -	≈ 0,21	≈ 0,21	≈ 0,21
E2.15.	E2i.15.	E2C.15.	30 .R.0	30	37,8	028   038   048   -	≈ 0,24	≈ 0,24	≈ 0,24
E2.15.	E2i.15.	E2C.15.	40 .R.0	40	47,8	028   038   048   075 <sup>1)</sup>	≈ 0,26	≈ 0,26	≈ 0,26
E2.15.	E2i.15.	E2C.15.	50 .R.0	50	57,8	028   038   048   -	≈ 0,29	≈ 0,29	≈ 0,29

1) Radius 075 only for Series E2C.15.40

Supplement Part No. with required radius ( $R$ ). Example: E2.15.20.038.0

## Dimensions

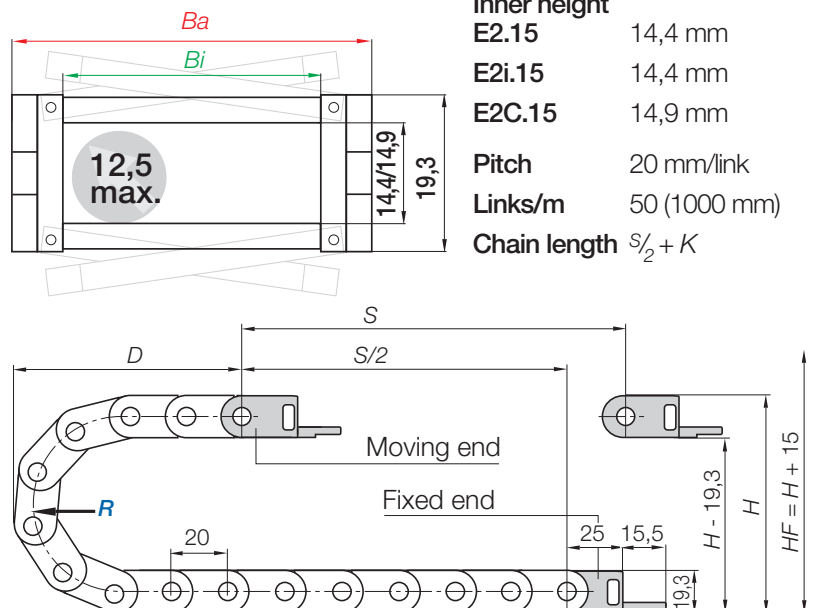
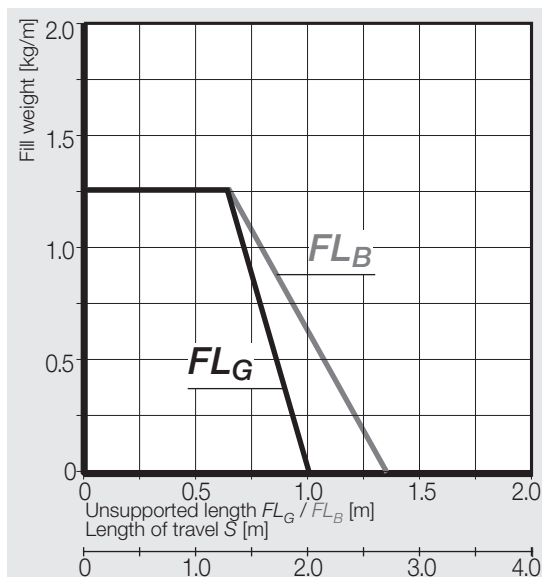

$R$	028	038	048	075*
$H$	75	95	115	169
$D$	68	78	88	115
$K$	130	160	195	280

The required clearance height:  $H_F = H + 15$  mm (with 0,3 kg/m fill weight)

1) Radius 075 only for Series E2C.15.40

## Mounting brackets, polymer one-piece | one side\* or two side pivoting | locking

<p><b>Moving end</b> E2.150..3PZ E2.150..5PZ E2.150..1PZ</p>	<p>two side pivoting one side* pivoting locking</p>	<p><b>Fixed end</b> E2.150...4PZ E2.150...6PZ E2.150...2PZ</p>	

\* One side pivoting: Pivot angle = bending radius.  
One side pivoting only to the inner radius - whether mounted to A1 to A4!

Width Index	Part No. full set with tiewrap plates two side pivoting	Part No. full set with tiewrap plates one side* pivoting	Part No. full set with tiewrap plates locking	Dim. A [mm]	Dim. B [mm]	Number of teeth
10. ▶	E2.150.10.34PZ	E2.150.10.56PZ	E2.150.10.12PZ	-	17,8	1
13. ▶	E2.150.13.34PZ	E2.150.13.56PZ	E2.150.13.12PZ	-	20,8	1
16. ▶	E2.150.16.34PZ	E2.150.16.56PZ	E2.150.16.12PZ	-	23,8	2
20. ▶	E2.150.20.34PZ	E2.150.20.56PZ	E2.150.20.12PZ	-	27,8	2
30. ▶	E2.150.30.34PZ	E2.150.30.56PZ	E2.150.30.12PZ	22	37,8	3
40. ▶	E2.150.40.34PZ	E2.150.40.56PZ	E2.150.40.12PZ	32	47,8	4
50. ▶	E2.150.50.34PZ	E2.150.50.56PZ	E2.150.50.12PZ	42	57,8	5

Possible installation conditions for assembled mounting brackets.  
For the **preassembled** mode please add index **A1... A4**.

### Part No. structure

**E2.150.20.34PZA1** A... must be indicated on preassembled configurations  
With strain relief tiewrap plates  
**Full set**  
Mounting bracket for selected width index

### Additional Features





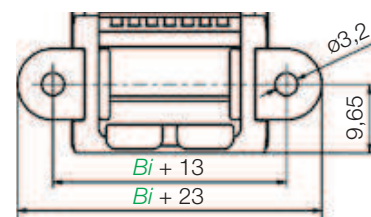



The quick flange can be clipped-in laterally in all mounting brackets.  
Housing for hexagonal nut or cylinder head screws M3. **Single:**  
Part No. E2.150.QF / incl. mounting bracket Part No. E2.150.20.34PZQF

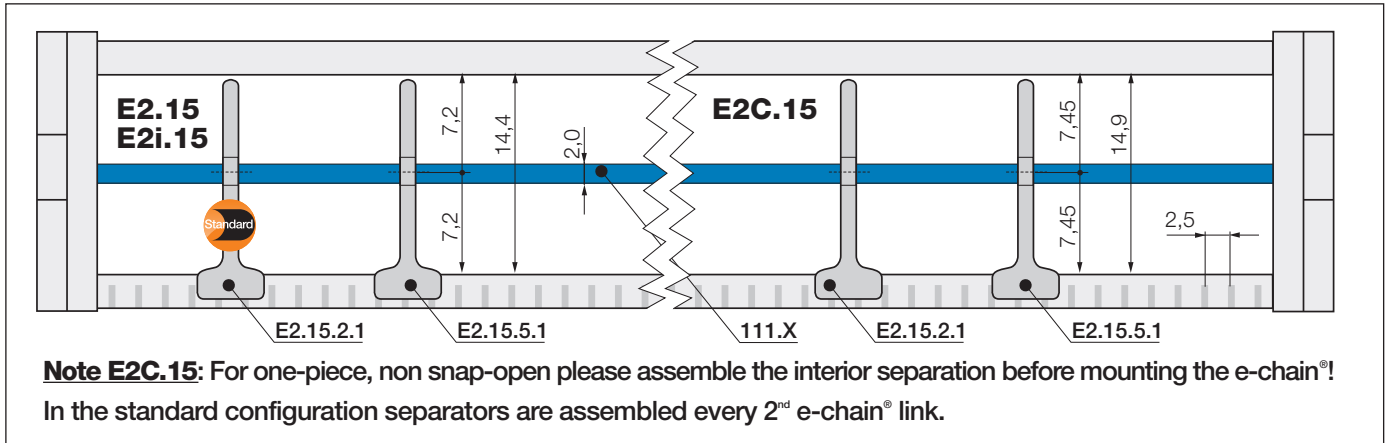

# E2 micro | Series E2.15 | Accessories

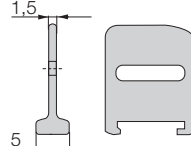
## Interior separation | New generation

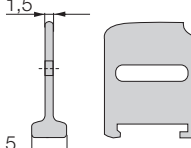

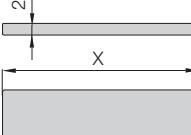
		<p><b>Standard separator, for e-chains®</b> unassembled <b>E2.15.2</b> assembled <b>E2.15.2.1</b></p>
		<p><b>Notch separator for notch crossbar</b> unassembled <b>E2.15.5</b> assembled <b>E2.15.5.1</b></p>
		<p><b>Full-width shelf e-chains®</b> unassembled <b>110.X</b> assembled <b>111.X</b></p>

### Standard - for all applications

Is used when vertical separation is required. Due to its slot, it allows basic vertical/horizontal shelving arrangements. No snap-in option, freely movable.

### Locks safely onto in 2,5 mm increments

For exact positioning in e-chains®. Recommended for side-mounted applications. Abrasion-optimized, cable-friendly design of the separator.

### Full-width shelf 110.X

This option makes sense in applications with many thin cables with similar diameters. For a consequent subdivision.

### Full-width shelves

Width X [mm]	unassembled	assembled	Width X [mm]	unassembled	assembled	Width X [mm]	unassembled	assembled
010	<b>110.10</b>	<b>111.10</b>	020	<b>110.20</b>	<b>111.20</b>	050	<b>110.50</b>	<b>111.50</b>
013	<b>110.13</b>	<b>111.13</b>	030	<b>110.30</b>	<b>111.30</b>			
016	<b>110.16</b>	<b>111.16</b>	040	<b>110.40</b>	<b>111.40</b>			

# E2 micro | Series E2.15 | Accessories

Assembly tools | Save assembly time

## Save assembly time - Interior separation assembly tool for the E2 micro "next generation"

● Convenient insertion of separators and shelves ● Significant assembly time reduction ● Grip and mount can be ordered separately and are easy to change  
More information ► [www.igus.eu/E2.1open](http://www.igus.eu/E2.1open)



## e-chain® opener for the E2 micro "next generation"

An e-chain® opener is included with every Series E2.10 and E2.15 that can be opened. The opening of the e-chain® links at high speeds saves significant installation time. Open a long piece of e-chain® in one go. It's the ideal tool for your own mounting or assembly lines to minimize processing time significantly.  
More information ► [www.igus.eu/E2.1open](http://www.igus.eu/E2.1open)

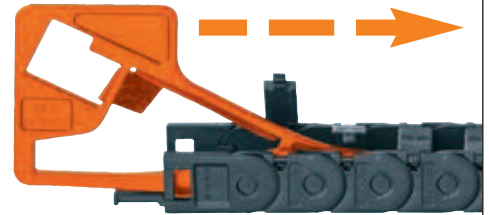

## Up to 75% less wear - Increase the service life of cables even further

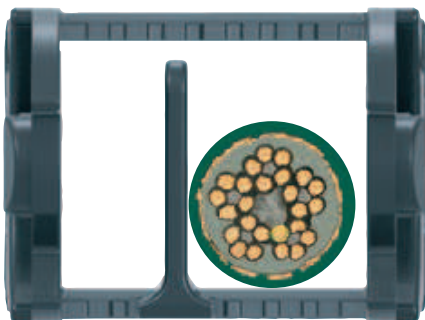

igus® separators optimally adapted to cable geometry.  
They increase the service life of the cables up to factor 4.

- Abrasion-optimized, cable-friendly design, long service life
- Mounting-optimized - a simpler and faster assembly
- Easy-to-use interior separation range for all applications
- Standard separator - no snap-in option, freely movable
- Notch separator - locks safely onto in 2,5 mm increments
- Partial horizontal subdivision is possible - Series E2.15

## X-ON Electronics

Largest Supplier of Electrical and Electronic Components

*Click to view similar products for [Cable Mounting & Accessories](#) category:*

*Click to view products by [Iigus](#) manufacturer:*

Other Similar products are found below :

[582603-1](#) [009333-000](#) [727844N003](#) [747](#) [809090N001](#) [843188-000](#) [8666](#) [967279N002](#) [DB-11](#) [1300840039](#) [1300900096](#) [1301800416](#)  
[1302264450](#) [1300830184](#) [1300830729](#) [1300900039](#) [1301580036](#) [1301850553](#) [1301860939](#) [1302000074](#) [1302261315](#) [1302264431](#)  
[1337706-2](#) [APA18-AK](#) [1724](#) [1-787307-1](#) [185491N001](#) [1868](#) [HP-6N](#) [C-202-C](#) [202C221-13-0](#) [CA7308-000](#) [8S23-75FR-CS8184](#) [2684](#) [9648](#)  
[3089](#) [988382-000](#) [A72821-000](#) [AA401](#) [173506-000](#) [1823](#) [202C292-13-0](#) [202C302-13-0](#) [2109](#) [300625](#) [3330](#) [3412](#) [356247-1](#) [M9142](#)  
[M9143](#)