

Cable glands, fittings and flexible conduits

ENGLISH

2017

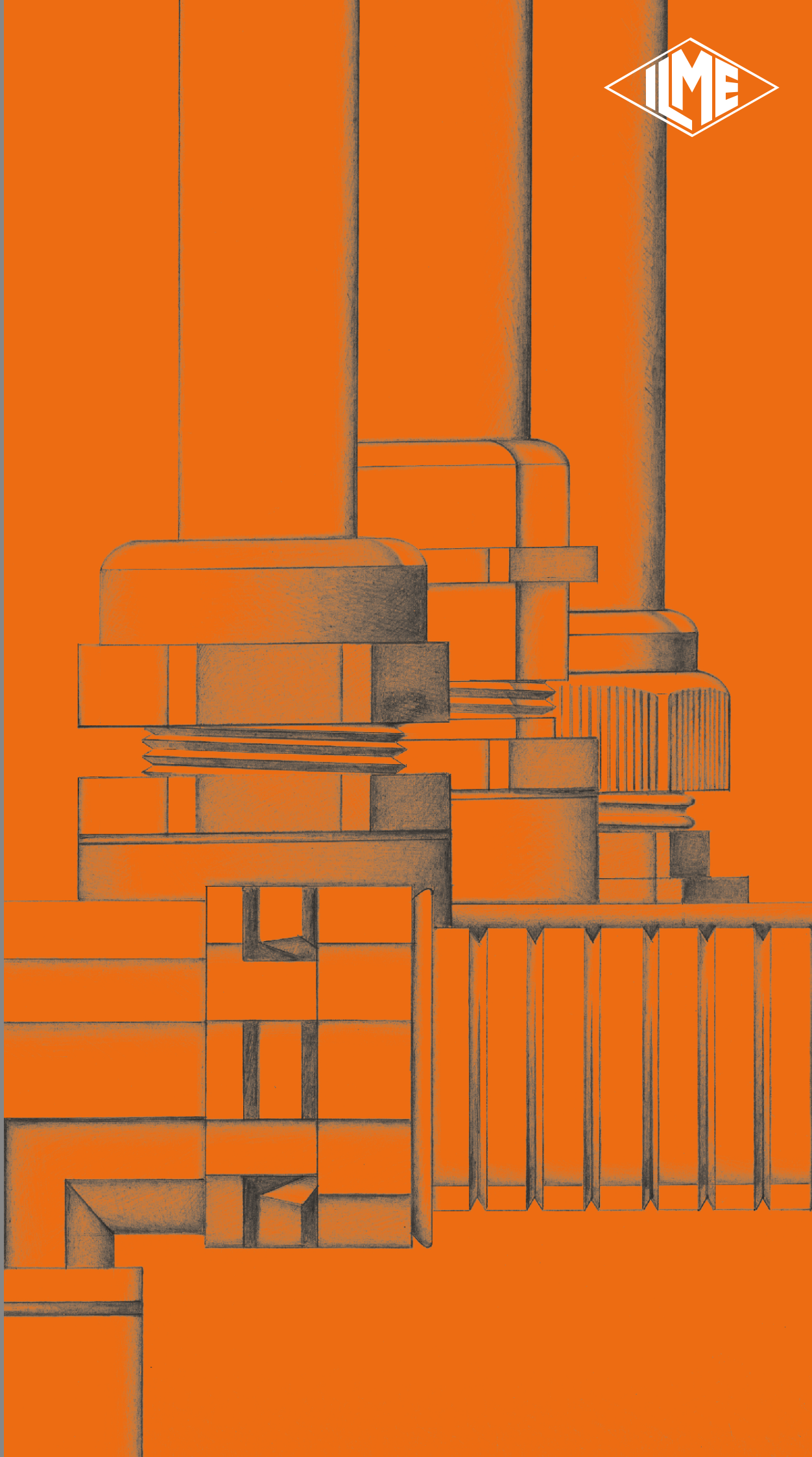

The company and the product

I.L.M.E. SpA - **INDUSTRIA LOMBARDA MATERIALE ELETTRICO** - has been operating in **Milan since 1938**, in particular in the electrotechnical sector for the manufacture of equipment for industrial installations. ILME reflects the traditional **entrepreneurial spirit of Lombardy**, and has enjoyed continuous expansion for over half a century. The company has carved an important role for itself in the principal world markets, also operating directly in the countries that have assumed world leadership in the field of automation, including Germany and Japan. In the **electrical connection** sector with applications in industrial automation, characterised by **top performance** and utmost **reliability** needs, ILME is today the acknowledged partner of many leading companies worldwide.



The company's fundamental values are: **Product innovation**, original solutions, excellent **price-quality ratio**, a customer-oriented **service**, ethical behaviour and respect for the environment.

To promote the continuing improvement of its qualitative **results**, ILME has always encouraged its collaborators to work with maximum **responsibility and participation**.

The company focuses on a series of benefits to the user, including research into the most suitable materials, high quality and safe cabling, a rapid turnaround and readily available services.

CE marking

As from 1st January 1997, in order to launch electrical products on the European market the manufacturer must ensure these bear the relevant CE marking, in line with the Low Voltage Directive 73/23/EEC * (implemented in Italy as L. D. 18-10-1977 no. 791) and its modification 93/68/EEC * (implemented in Italy as L.D. 25-11-1996 no. 626/96, published in the supplement to the Gazzetta Ufficiale of 14-12-1996).

The CE marking must be visible on the product or, if this is not possible, on the packaging, the instructions for use or on the warranty certificate. It acts as a declaration by the manufacturer that the product complies with all relevant EU directives regarding its field of application.

ILME products bear the CE marking on the actual product or its packaging.

Almost all ILME products fall within the scope of the Low Voltage Directive. A declaration of conformity is required in order to be able to apply the CE marking. This declaration, to which the market is not directly entitled, must be made available to the controlling authorities (in Italy, the Ministry for Industry, Commerce and Handicraft) at all times. In it, the manufacturer declares the technical safety standard(s) followed in the manufacture of the product. These standards must be, in decreasing order of preference:

- a European standard (EN prefix)
- a European harmonisation document (HD prefix)
- an international IEC standard
- a national standard
- in the absence of reference standards, the manufacturer's internal specifications guaranteeing compliance with the basic safety requirements of the directive.

Compliance with harmonised technical standards (i.e. ratified by CENELEC) also constitutes presumption of compliance with the basic safety requirements of the directives.

The CE marking of ILME products results from the declaration of conformity of the product to harmonised standards or international IEC standards.

Through the CE marking, ILME declares full compliance, not merely with the directive's basic safety requirements, but also with those international or national EU standards on which voluntary safety certification markings are based (e.g. IMQ and VDE). In this way, ILME intends to give the CE marking the value of self-certification in terms of safety, given the loss in legal value of voluntary certifications issued by third parties, ratified by directive 93/68/EEC*.

Notwithstanding the above, practically all ILME products still bear voluntary conformity markings.

The above mentioned EU declaration of conformity becomes null and void when the assembly of products includes one or more components not manufactured by ILME and without CE marking.

***Note:** The next legal reference for the Low Voltage Directive was 2006/95/EC, as consolidation of the original Directive 73/23/EEC + Directive 93/68/EEC. On 29th March 2014, the Official Journal of the European Union published the new Low Voltage directive 2014/35/EU dd. 26th February 2014, a recast version of directive 2006/95/EC, which is in force since on 20th April 2016.

The information contained in this catalogue is not binding and may be changed without notice.



UNI EN ISO 9001: 2015
Design, manufacture and distribution
of industrial electrical equipment (IAF 19)
Certificate N° 50 100 11133

Composition of the part No.: e.g. **AS C 11 P**

article series _____
 metric or Pg threading _____
 threading size _____
 version _____

Metal cable glands

	semi-cable gland multiple gasket		semi-cable gland full gasket		complete cable gland		complete cable gland increased threading	
metric								
Pg								
	AS C	AG M	AS C		AS C	AS M	AS C	AS M
	11 13 16 21 29 36 42	20 25 32 40 50	11 13 16 21 29		11 13 16 21 29 36 42	20 25 32 40 50	11 13 16 21 29	20 25 32 40 50
	T	T	O		P	P	PH	PH

	complete EMC cable gland		cable clamps with/ without collar		sealing plugs		reduction nipples	
metric								
Pg								
	AS C	AS M	CRS		AS C	AS M	AS C	AS M
	11 13 16 21 29	20 25 32	13 16 21 29 36 42		11 13 16 21 29 36 42	20 25 32 40 50	11 13 16 21 29 36 42	20 25 32 40 50
	E	E			B	B	C	C

Composition of the part No.: e.g. **AS M 20 P**

article series _____
 metric or Pg threading _____
 threading size _____
 version _____

Insulating cable glands

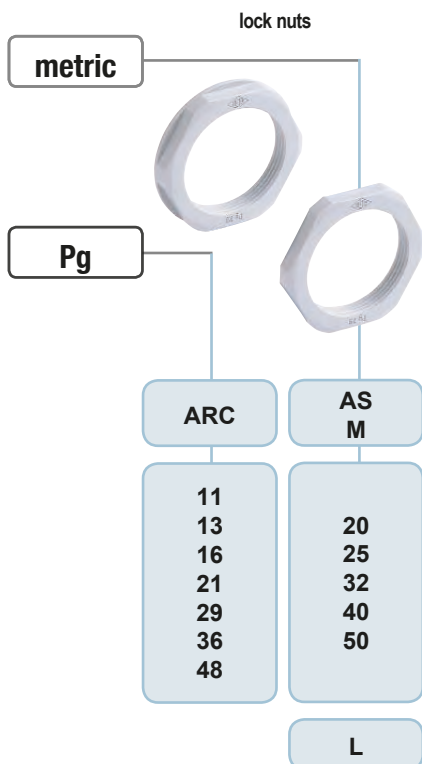
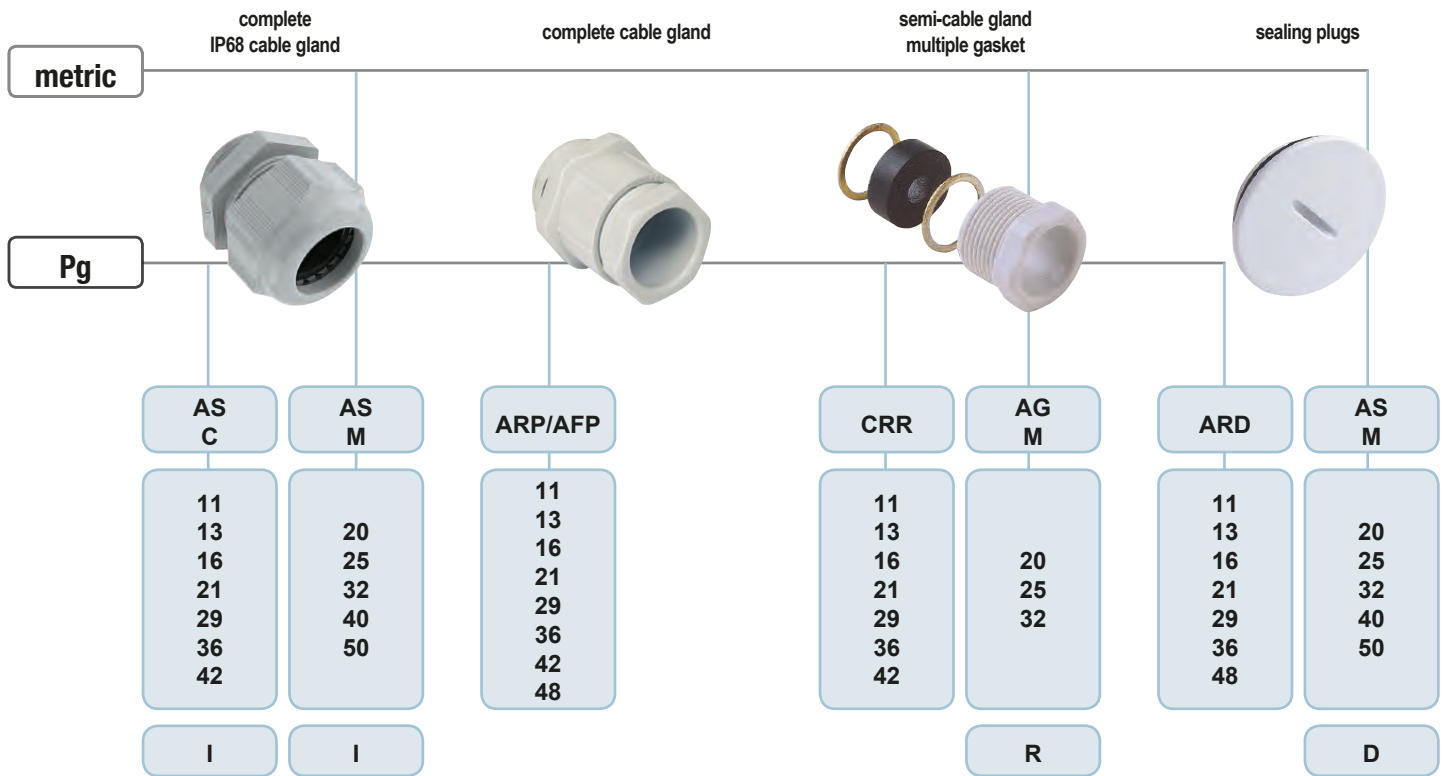

Composition of the part No.: e.g. **AW M 20 PHX**

article series _____
 metric or Pg threading _____
 threading size _____
 version _____

Metal cable glands

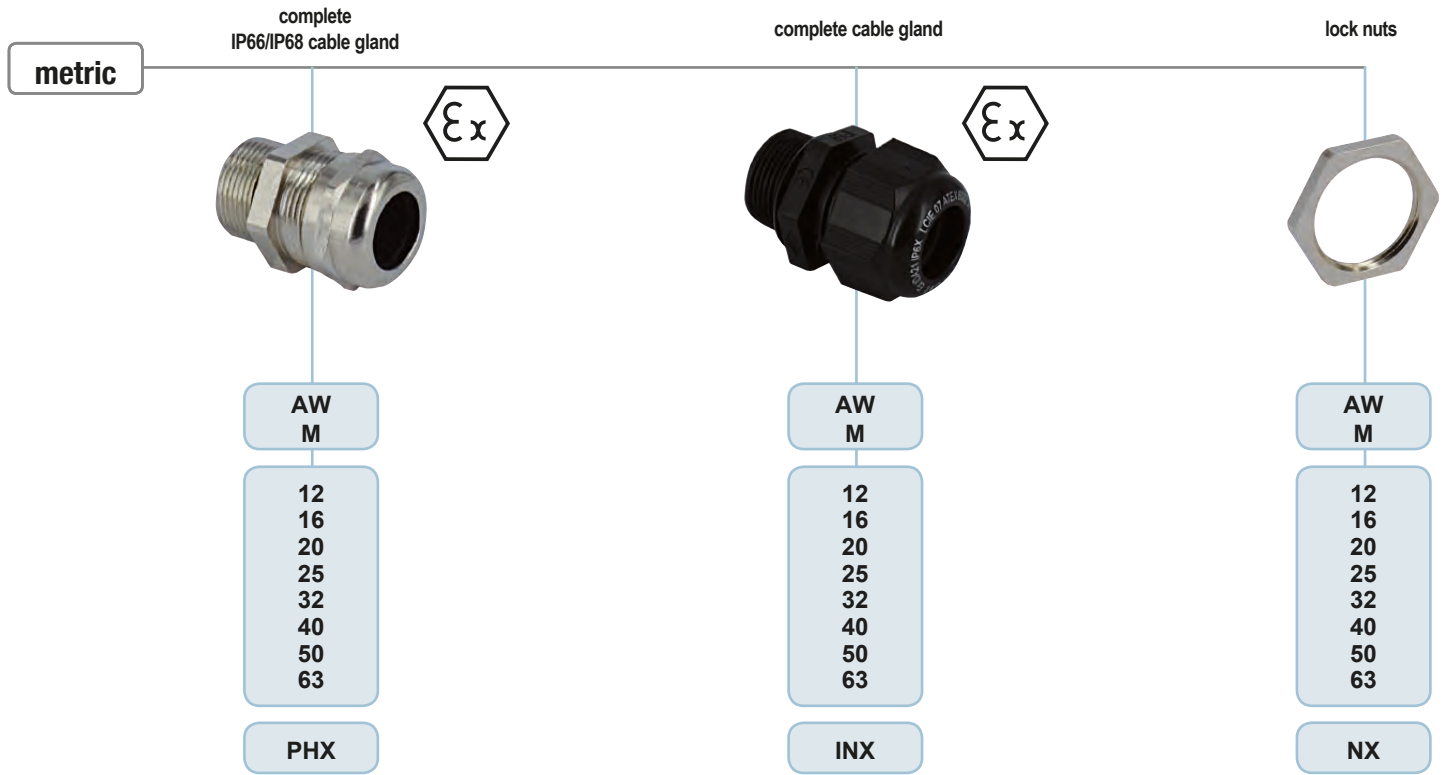

Diameter of cables that may be used with cable glands

Pg threading

Ø in mm

series	11	13,5	16	21	29	36	42	48
AS C..P	from 5 to 10,5	from 6 to 12,5	from 7 to 14,5	from 10 to 18	from 14 to 24	from 23 to 30	from 26 to 35	
AS C..PH	from 5 to 10,5	from 6 to 12,5	from 7 to 14,5	from 10 to 18	from 14 to 24			
AS C..E	from 7 to 10,5	from 8 to 12,5	from 10 to 14,5	from 13,5 to 18	from 17 to 24	from 24 to 30		
CRS..		12	14	18	25	32	38	
CRS..C *			7,5-10-12,5-15	10-13-16-19				
AS C..O	9	11	13	16	25			
AS C..T	7,5-10	7,5-10-12,5	7,5-10-12,5-15	10-13-16-19	18-21-24-27	24-27-30-33	30-33-36-39	
AS C..I	from 3,5 to 10	from 5 to 12	from 7 to 14	from 9 to 18	from 14 to 25	from 18 to 32	from 24 to 38,5	
AFPI/ARP	7,5-10-12,5	7,5-10-12,5	7,5-10-12,5-15	10-13-16-19	18-21-24-27	24-27-30-33	30-33-36-39	36-39-42-45
CRR..	5-7,5-10-12,5	7,5-10-12,5	7,5-10-12,5-15	10-13-16-19	18-21-24-27	24-27-30-33	30-33-36-39	

*Kit with multiple gasket

Metric threading

Ø in mm

series	12	16	20	25	32	40	50	63
AS M..P			from 6 to 12,5	from 10 to 18	from 14 to 24	from 15 to 24	from 23 to 30	
AS M..PH			from 6 to 12,5	from 10 to 18	from 14 to 24	from 15 to 24	from 23 to 30	
AS M..E			from 8 to 12,5	from 13,5 to 18	from 17 to 24	from 24 to 30		
AG M..T			7 -10-13	11-14-17	19-21-24	26-29-32	35-38-41	
AG M..I			from 5 to 12,5	from 9 to 18	from 14 to 25	from 18 to 32	from 24 to 38,5	
AG M..R			7-10-13	11-14-17	19-21-24			
AW M..PHX	from 4,0 to 7,0	from 5,0 to 10,0	from 6,0 to 13,0	from 10,0 to 17,0	from 13,0 to 21,0	from 16,0 to 28,0	from 21,0 to 35,0	from 34,0 to 48,0
AW M..INX	from 3,0 to 6,0	from 4,5 to 9,0	from 7,0 to 13,0	from 10,0 to 17,0	from 13,0 to 21,0	from 17,0 to 28,0	from 23,0 to 35,0	from 34,0 to 48,0

AS metal cable glands



- IP68 degree of protection (EN 60529)
- temperature range -25 °C / +120 °C
- metric threading according to EN 60423 and EN 62444
- Pg threading according to DIN 40430 and DIN 46320
- anti-aging rubber gaskets
- Pg 36/42 - M40/50 cable glands temperature range -30 °C / +95 °C
- long thread with temperature range -40 °C / +100 °C

complete cable gland in nickel-plated brass



complete cable gland in nickel-plated brass long*



description	part No.	Pg or M threading	part No.	Pg or M threading
- for cable Ø 6 - 10 mm	AS C11P	Pg 11	AS C11PH	Pg 11
- for cable Ø 8 - 12 mm	AS C13P	Pg 13,5	AS C13PH	Pg 13,5
- for cable Ø 9,5 - 14 mm	AS C16P	Pg 16	AS C16PH	Pg 16
- for cable Ø 11,5 - 18 mm	AS C21P	Pg 21	AS C21PH	Pg 21
- for cable Ø 15 - 24 mm	AS C29P	Pg 29	AS C29PH	Pg 29
- for cable Ø 23 - 30 mm	AS C36P	Pg 36		
- for cable Ø 26 - 35 mm	AS C42P	Pg 42		
- for cable Ø 8 - 12 mm	AS M20P	M 20	AS M20PH	M 20
- for cable Ø 11,5 - 18 mm	AS M25P	M 25	AS M25PH	M 25
- for cable Ø 15 - 24 mm	AS M32P	M 32	AS M32PH	M 32
- for cable Ø 15 - 24 mm	AS M40P	M 40	AS M40PH	M 40
- for cable Ø 23 - 30 mm	AS M50P	M 50	AS M50PH	M 50

*for use with:

- metal lock nuts (page 9)
- multipole connector enclosures CF/MF 6/10/16/24/32/48/50 (new version)
- IP68 high protection multipole connector enclosures
- BIG enclosures

dimensions in mm

AS C..P - AS M..P

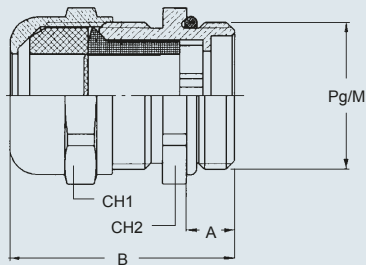

AS C..P	A	B	CH1	CH2
11	6	26	20	20
13,5	6,5	28	22	22
16	6,5	30	24	24
21	7	35	30	30
29	8	43	40	40
36	9	50	50	50
42	10	57	58	58

AS M..P	A	B	CH1	CH2
20	7	29	22	22
25	8	37	30	30
32	8,5	45	40	40
40	8,5	45	40	42
50	9,5	51	50	55

dimensions in mm

AS C..PH - AS M..PH

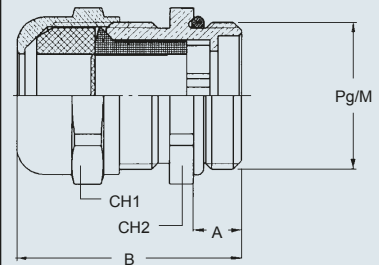

AS C..PH	A	B	CH1	CH2
11	15	35	20	20
13,5	15	36,5	22	22
16	15	38,5	24	24
21	15	43	30	30
29	15	50	40	40

AS M..PH	A	B	CH1	CH2
20	13	35	22	22
25	14	43	30	30
32	14,5	51	40	40
40	14,5	51	40	42
50	15,5	57	50	55

dimensions shown are not binding and may be changed without notice

- IP68 class of protection (EN 60529)
- temperature range -25 °C / +120 °C
- metric threading according to EN 60423 and EN 62444
- Pg threading according to DIN 40430 and DIN 46320
- anti-aging rubber internal gasket
- screening hold system

complete EMC cable gland in nickel-plated brass



description	part No.	Pg or M threading
- for cable Ø 7 - 10,5 mm	AS C11E	Pg 11
- for cable Ø 8 - 12,5 mm	AS C13E	Pg 13,5
- for cable Ø 10 - 14,5 mm	AS C16E	Pg 16
- for cable Ø 13,5 - 18 mm	AS C21E	Pg 21
- for cable Ø 17 - 24 mm	AS C29E	Pg 29
- for cable Ø 24 - 30 mm	AS C36E	Pg 36
- for cable Ø 8 - 12,5 mm	AS M20E	M 20
- for cable Ø 13,5 - 18 mm	AS M25E	M 25
- for cable Ø 17 - 24 mm	AS M32E	M 32
- for cable Ø 24 - 30 mm	AS M40E	M 40

dimensions in mm

AS C..E - AS M..E

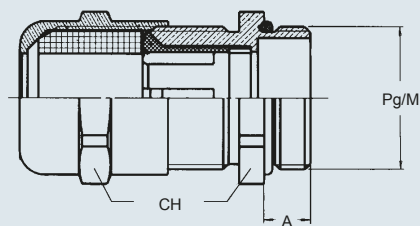

AS C..E	A	CH
11	6	20
13,5	6,5	22
16	6,5	24
21	7	30
29	8	40
36	9	50

AS M..E	A	CH
20	7	22
25	8	30
32	8,5	40
40	8,5	50

dimensions shown are not binding
and may be changed without notice

CR metal cable glands



- IP65 degree of protection (EN 60529) for use with connector enclosures
- Pg threading according to DIN 40430 and DIN 46320
- made of die-cast aluminum alloy
- anti-aging rubber gasket
- washers in zinc-plated steel

metal cable clamps with collar, including gaskets and washers



metal cable clamps without collar, gaskets and washers



description	part No.	Pg threading	part No.	Pg threading
- rubber hole Ø 12 mm	CRS 13.5	13,5		
- rubber hole Ø 14 mm	CRS 16	16		
- rubber hole Ø 18 mm	CRS 21	21		
- rubber hole Ø 25 mm	CRS 29	29		
- rubber hole Ø 32 mm	CRS 36	36		
- rubber hole Ø 38 mm	CRS 42	42		
without gasket and washer, not coated (order separately)			CRS 16 C	
- threading Pg 16			CRS 21 C	
- threading Pg 21				
kit comprising a full gasket and two washers (for cable anchoring CRS..C)			CRA 16	16
- rubber hole Ø 14 mm			CRA 21	21
- rubber hole Ø 18 mm				
kit comprising a multiple gasket and two washers (for cable anchoring CRS..C)			CRAC 16	16
- rubber hole Ø 7,5 - 10 - 12,5 - 15 mm			CRAC 21	21
- rubber hole Ø 10 - 13 - 16 - 19 mm				

dimensions in mm

CRS

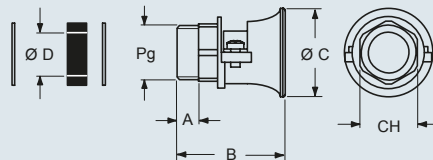

CRS	A	B	Ø C	Ø D	CH
13,5	7	36	28	12	22
16	8,5	41	32	14	24
21	10	47	39	18	30
29	10,5	58	55	25	41
36	13	67,5	67	32	50
42	13	72,5	75	38	55

dimensions in mm

CRS..C

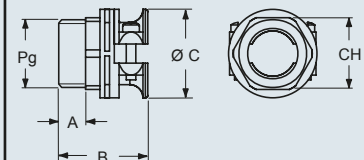

CRS..C	A	B	Ø C	CH
16	8	30	30	24
21	10	36	37	30

CRA

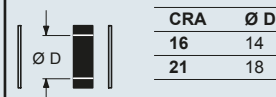

CRA	Ø D
16	14
21	18

CRAC

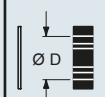

CRAC	Ø D
16	7,5 - 10 - 12,5 - 15
21	10 - 13 - 16 - 19

dimensions shown are not binding and may be changed without notice

AS - AG metal cable glands



- IP65 degree of protection (EN 60529) for use with connector enclosures
- temperature range -25 °C / +100 °C
- metric threading according to EN 60423 and EN 62444
- Pg threading according to DIN 40430 and DIN 46320
- anti-aging rubber gasket
- galvanised steel washers

semi-cable gland full gasket in nickel-plated brass



semi-cable gland multiple gasket in nickel-plated brass



description	part No.	Pg threading	part No.	Pg or M threading
- for cable Ø 9	AS C110	11		
- for cable Ø 11	AS C130	13,5		
- for cable Ø 13	AS C160	16		
- for cable Ø 16	AS C210	21		
- for cable Ø 25	AS C290	29		
- for cable Ø 7,5 - 10			AS C11T	Pg 11
- for cable Ø 7,5 - 10 - 12,5			AS C13T	Pg 13,5
- for cable Ø 7,5 - 10 - 12,5 - 15			AS C16T	Pg 16
- for cable Ø 10 - 13 - 16 - 19			AS C21T	Pg 21
- for cable Ø 18 - 21 - 24 - 27			AS C29T	Pg 29
- for cable Ø 24 - 27 - 30 - 33			AS C36T	Pg 36
- for cable Ø 30 - 33 - 36 - 39			AS C42T	Pg 42
- for cable Ø 7 - 10 - 13			AG M20T	M 20
- for cable Ø 11 - 14 - 17			AG M25T	M 25
- for cable Ø 19 - 21 - 24			AG M32T	M 32
- for cable Ø 26 - 29 - 32			AG M40T	M 40
- for cable Ø 35 - 38 - 41			AG M50T	M 50

dimensions in mm

AS C..O

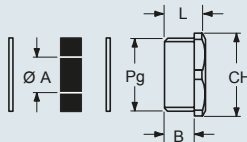

AS C..O	CH	Ø A	B	L
11	18	9	6	9
13	20	11	7,5	10,5
16	22	13	7,5	10,5
21	28	16	8	11,5
29	37	25	8	12

dimensions in mm

AS C..T - AG M..T

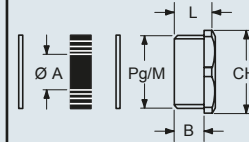

AS C..T	CH	Ø A	B	L
11	18	7,5 - 10	6	9
13	20	7,5 - 10 - 12,5	7,5	10,5
16	22	7,5 - 10 - 12,5 - 15	7,5	10,5
21	28	10 - 13 - 16 - 19	8	11,5
29	37	18 - 21 - 24 - 27	8	12
36	47	24 - 27 - 30 - 33	9,5	14
42	54	30 - 33 - 36 - 39	10	16

AG M..T	CH	Ø A	B	L
20	20	6 - 8 - 10	7,5	10,5
25	25	11 - 14 - 17	8	11,5
32	32	19 - 21 - 24	8	12
40	40	26 - 29 - 32	8	12
50	50	35 - 38 - 41	9,5	14

dimensions shown are not binding
and may be changed without notice

- IP68 degree of protection (EN 60529)
- metric threading according to EN 60423 and EN 62444
- Pg threading according to DIN 40430 and DIN 46320
- anti-aging rubber O-ring gasket
- temperature range -25 °C / +120 °C

sealing plug in nickel-plated brass



description	part No.	Pg or M threading
- for Pg 11 threading	AS C11B	Pg 11
- for Pg 13,5 threading	AS C13B	Pg 13,5
- for Pg 16 threading	AS C16B	Pg 16
- for Pg 21 threading	AS C21B	Pg 21
- for Pg 29 threading	AS C29B	Pg 29
- for Pg 36 threading	AS C36B	Pg 36
- for Pg 42 threading	AS C42B	Pg 42
- for M 20 threading	AS M20B	M 20
- for M 25 threading	AS M25B	M 25
- for M 32 threading	AS M32B	M 32
- for M 40 threading	AS M40B	M 40
- for M 50 threading	AS M50B	M 50

dimensions in mm

AS C..B - AS M..B



AS C..B	Ø	A	L
11	20	6	9
13,5	22	6,5	9,5
16	24	6,5	9,5
21	30	7	11
29	39	8	12
36	50	9	15
42	57	10	16

AS M..B	Ø	A	L
20	22	6,5	8,5
25	27	7	10
32	34	8	11
40	44	9	13
50	54	10	14,5

dimensions shown are not binding
and may be changed without notice

AS metal cable glands



- metric threading according to EN 60423 and EN 62444
- Pg threading according to DIN 40430 and DIN 46320
- anti-aging rubber O-ring gasket

reduction nipples in nickel-plated brass including gasket



lock nuts in nickel-plated brass

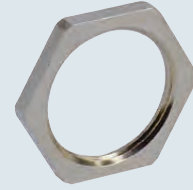

description	part No.	part No.	Pg or M threading
- male Pg 11 / female Pg 13,5 threading - male Pg 13,5 / female Pg 16 threading - male Pg 16 / female Pg 21 threading - male Pg 21 / female Pg 29 threading - male Pg 29 / female Pg 36 threading - male Pg 36 / female Pg 42 threading - male Pg 42 / female Pg 48 threading	AS C11C AS C13C AS C16C AS C21C AS C29C AS C36C AS C42C		
- male M 20 / female M 25 threading - male M 25 / female M 32 threading - male M 32 / female M 40 threading - male M 40 / female M 50 threading - male M 50 / female M 63 threading	AS M20C AS M25C AS M32C AS M40C AS M50C		
- for Pg 11 threading - for Pg 13,5 threading - for Pg 16 threading - for Pg 21 threading - for Pg 29 threading - for Pg 36 threading - for Pg 42 threading - for Pg 48 threading		AS C11N AS C13N AS C16N AS C21N AS C29N AS C36N AS C42N AS C48N	Pg 11 Pg 13,5 Pg 16 Pg 21 Pg 29 Pg 36 Pg 42 Pg 48
- for M 20 threading - for M 25 threading - for M 32 threading - for M 40 threading - for M 50 threading		AS M20N AS M25N AS M32N AS M40N AS M50N	M 20 M 25 M 32 M 40 M 50

dimensions in mm

AS C..C



AS C..C	Pg M	Pg F	A	L
11	11	13,5	6	17,5
13,5	13,5	16	6,5	19
16	16	21	6,5	21
21	21	29	7	23
29	29	36	8	28
36	36	42	9	31
42	42	48	10	33

AS M..C

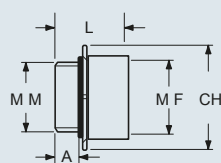

AS M..C	M M	M F	CH	A	L
20	20	25	28	7	20
25	25	32	36	8	21,5
32	32	40	42	8,5	22
40	40	50	52	8,5	23
50	50	63	65	9,5	25

dimensions in mm

AS C..N - AS M..N

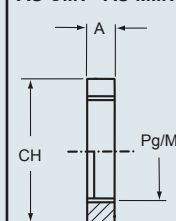

AS C..N	A	CH
11	2,9	21
13,5	3,1	23
16	3,1	26
21	3,6	32
29	4,1	41
36	5,1	51
42	5,1	60
48	5,6	64

AS M..N	A	CH
20	3,5	24
25	3,5	30
32	4,5	35
40	4,5	45
50	5,5	55

dimensions shown are not binding and may be changed without notice

AS - AR - AF insulating cable glands



- AS...I IP68 degree of protection (EN 60529)⁽¹⁾ for use with lock nuts (page 12)
- ARP/AFP IP67 degree of protection (EN 60529)
- temperature range -25 °C / +100 °C
- metric threading according to EN 60423 and EN 62444
- Pg threading according to DIN 40430 and DIN 46320
- anti-aging rubber gaskets
- AS C/AS M grey RAL 7001, AS C11I / AS M 20I grey RAL 7035, AS C11IN / AS M20IN black RAL 9005

complete insulating cable gland⁽²⁾

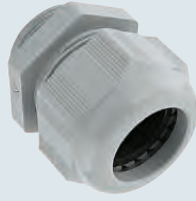

complete insulating cable gland



description	part No.	Pg or M threading	part No.	Pg threading
- for cable Ø 3,5 - 10 mm	AS C11I	grey	Pg 11	
- for cable Ø 3,5 - 10 mm	AS C11IN	black	Pg 11	
- for cable Ø 5 - 12 mm	AS C13I		Pg 13,5	
- for cable Ø 7 - 14 mm	AS C16I		Pg 16	
- for cable Ø 9 - 18 mm	AS C21I		Pg 21	
- for cable Ø 14 - 25 mm	AS C29I		Pg 29	
- for cable Ø 18 - 32 mm	AS C36I		Pg 36	
- for cable Ø 24 - 38,5 mm	AS C42I		Pg 42	
- for cable Ø 5 - 12,5 mm	AS M20I	grey	M 20	
- for cable Ø 5 - 12,5 mm	AS M20IN	black	M 20	
- for cable Ø 9 - 18 mm	AS M25I		M 25	
- for cable Ø 14 - 25 mm	AS M32I		M 32	
- for cable Ø 18 - 32 mm *	AS M40I		M 40	
- for cable Ø 24 - 38,5 mm *	AS M50I		M 50	
- rubber hole Ø 7,5 - 10 - 12,5 mm			ARP 11	11
- rubber hole Ø 7,5 - 10 - 12,5 mm			ARP 13	13,5
- rubber hole Ø 7,5 - 10 - 12,5 - 15 mm			AFP 16	16
- rubber hole Ø 10 - 13 - 16 - 19 mm			AFP 21	21
- rubber hole Ø 18 - 21 - 24 - 27 mm			AFP 29	29
- rubber hole Ø 24 - 27 - 30 - 33 mm			AFP 36	36
- rubber hole Ø 30 - 33 - 36 - 39 mm			ARP 42	42
- rubber hole Ø 36 - 39 - 42 - 45 mm			ARP 48	48

(1) AS...I IP65 degree of protection for use with connector enclosures; IP68 if mounted with gasket (page 27).

(2) UL, VDE, CSA approval

dimensions in mm

AS C..I - AS M..I

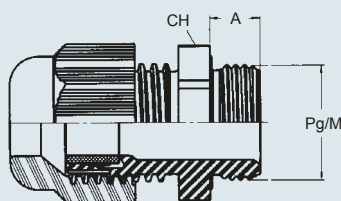

AS C..I	A	CH
11	8	22
13	9	24
16	10	27
21	11	33
29	11	42
36	13	53
42	13	60

AS M..I	A	CH
20	10	24
25	10	33
32	10	42
40	10	53
50	12	60

dimensions in mm

ARP / AFP

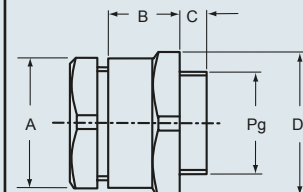

part No	A	B	C	D	Pg
ARP 11	19	20	9	24	11
ARP 13	22	19,5	9	26	13,5
AFP 16	24	21	10	29	16
AFP 21	30	26	10	39	21
AFP 29	41	29,5	10	50	29
AFP 36	50	33,5	10	58	36
ARP 42	54	28	12,5	60	42
ARP 48	64	41,5	13,5	77	48

dimensions shown are not binding and may be changed without notice

- IP65 degree of protection (EN 60529) for use with connector enclosures
- metric threading according to EN 60423 and EN 62444
- Pg threading according to DIN 40430 and DIN 46320
- anti-aging rubber gasket
- washers in zinc-plated steel

semi-cable gland with multiple gasket in insulating material



description	part No.	Pg or M threading
- for cable Ø 7,5 - 10 - 12,5	CRR 11 white	Pg 11
- for cable Ø 7,5 - 10 - 12,5	CRR 11 N black	Pg 11
- for cable Ø 7,5 - 10 - 12,5	CRR 13	Pg 13,5
- for cable Ø 7,5 - 10 - 12,5 - 15	CRR 16	Pg 16
- for cable Ø 10 - 13 - 16 - 19	CRR 21	Pg 21
- for cable Ø 18 - 21 - 24 - 27	CRR 29	Pg 29
- for cable Ø 24 - 27 - 30 - 33	CRR 36	Pg 36
- for cable Ø 30 - 33 - 36 - 39	CRR 42	Pg 42
- for cable Ø 7 - 10 - 13	AG M20R white	M 20
- for cable Ø 7 - 10 - 13	AG M20RN black	M 20
- for cable Ø 11 - 14 - 17	AG M25R	M 25
- for cable Ø 19 - 21 - 24	AG M32R	M 32

dimensions in mm

CRR - AG M..R



CRR	CH	Ø A
11	19	7,5 - 10 - 12,5
11 N	19	7,5 - 10 - 12,5
13	22	7,5 - 10 - 12,5
16	24	7,5 - 10 - 12,5 - 15
21	30	10 - 13 - 16 - 19
29	41	18 - 21 - 24 - 27
36	50	24 - 27 - 30 - 33
42	60	30 - 33 - 36 - 39

AG M..R	CH	Ø A
20	21	7 - 10 - 13
20 N	21	7 - 10 - 13
25	26	11 - 14 - 17
32	34	19 - 21 - 24

dimensions shown are not binding and may be changed without notice

AR - AS insulating cable glands



- in thermoplastic material
- anti-aging rubber gasket
- metric threading according to EN 60423 and EN 62444
- Pg threading according to DIN 40430 and DIN 46320

insulating sealing plugs



lock nuts



description	part No.	Pg or M threading	part No.	Pg or M threading
- for Pg 11 threading	ARD 11	Pg 11		
- for Pg 13,5 threading	ARD 13	Pg 13,5		
- for Pg 16 threading	ARD 16	Pg 16		
- for Pg 21 threading	ARD 21	Pg 21		
- for Pg 29 threading	ARD 29	Pg 29		
- for Pg 36 threading	ARD 36	Pg 36		
- for Pg 48 threading	ARD 48	Pg 48		
- for M 20 threading	AS M20D	M 20		
- for M 25 threading	AS M25D	M 25		
- for M 32 threading	AS M32D	M 32		
- for M 40 threading	AS M40D	M 40		
- for M 50 threading	AS M50D	M 50		
- for Pg 11 threading			ARC 11	Pg 11
- for Pg 13,5 threading			ARC 13	Pg 13,5
- for Pg 16 threading			ARC 16	Pg 16
- for Pg 21 threading			ARC 21	Pg 21
- for Pg 29 threading			ARC 29	Pg 29
- for Pg 36 threading			ARC 36	Pg 36
- for Pg 48 threading			ARC 48	Pg 48
- for M 20 threading			AS M20L	M 20
- for M 25 threading			AS M25L	M 25
- for M 32 threading			AS M32L	M 32
- for M 40 threading			AS M40L	M 40
- for M 50 threading			AS M50L	M 50

dimensions in mm

ARD - AS M..D

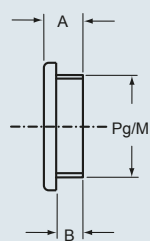

part No.	A	B
ARD 11	7,5	6
ARD 13	7,5	6
ARD 16	7,5	6
ARD 21	10	8
ARD 29	10	8
ARD 36	12	10
ARD 48	14	12

part No.	A	B
AS M20D	10,5	8
AS M25D	11	8
AS M32D	13,5	10
AS M40D	14	10
AS M50D	17	12

dimensions in mm

ARC

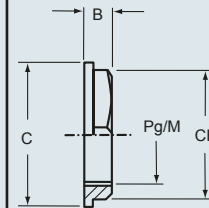

part No.	CH	B	C
ARC 11	24	5	26
ARC 13	27	6	29
ARC 16	30	6	33
ARC 21	36	7	39
ARC 29	46	7	50
ARC 36	60	8	66
ARC 48	70	8	78

AS M..L

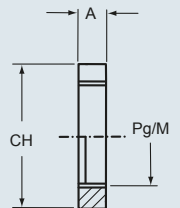

part No.	CH	A
AS M20L	24	5
AS M25L	30	6
AS M32L	38	7,5
AS M40L	50	8
AS M50L	60	9

dimensions shown are not binding and may be changed without notice

- IP66/IP68 degree of protection (5 bar; 30 min - EN 60529)
- temperature range -40 °C / +75 °C
- metric threading according to EN 60423 and EN 62444
- EPDM gasket

complete cable gland in nickel-plated brass, long thread *



description	part No.	M threading
- for cable Ø 4,0 - 7,0 mm	AW M12PHX	M 12
- for cable Ø 5,0 - 10,0 mm	AW M16PHX	M 16
- for cable Ø 6,0 - 13,0 mm	AW M20PHX	M 20
- for cable Ø 10,0 - 17,0 mm	AW M25PHX	M 25
- for cable Ø 13,0 - 21,0 mm	AW M32PHX	M 32
- for cable Ø 16,0 - 28,0 mm	AW M40PHX	M 40
- for cable Ø 21,0 - 35,0 mm	AW M50PHX	M 50
- for cable Ø 34,0 - 48,0 mm	AW M63PHX	M 63



II 2 G Ex e IIC Gb



II 2 D Ex tb IIIC Db IP68

* to be used with metal lock nuts (page 14)

dimensions in mm

AW M..PHX

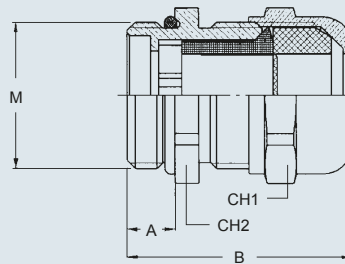

AW M..PHX	A	B min	B max	CH1	CH2
12	12,0	30,0	37,0	16,0	16,0
16	12,0	33,0	41,0	20,0	20,0
20	12,0	35,0	43,0	24,0	24,0
25	12,0	38,0	47,0	29,0	29,0
32	15,0	43,0	51,0	36,0	36,0
40	15,0	51,0	62,0	46,0	46,0
50	15,0	57,0	68,0	55,0	55,0
63	15,0	61,0	72,0	68,0	68,0

dimensions shown are not binding and may be changed without notice

AW..NX lock nuts



- metric threading according to EN 60423 and EN 62444

**lock nuts
in nickel-plated brass**

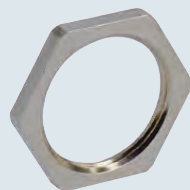

description	part No.	M threading
- for M 12 threading	AW M12NX	M 12
- for M 16 threading	AW M16NX	M 16
- for M 20 threading	AW M20NX	M 20
- for M 25 threading	AW M25NX	M 25
- for M 32 threading	AW M32NX	M 32
- for M 40 threading	AW M40NX	M 40
- for M 50 threading	AW M50NX	M 50
- for M 63 threading	AW M63NX	M 63

dimensions shown are not binding
and may be changed without notice

- IP66/IP68 degree of protection (5 bar; 30 min - EN 60529)
- temperature range -40 °C / +75 °C
- metric threading according to EN 60423 and EN 62444
- in thermoplastic material

complete insulating cable gland *



description

part No.

M
threading

- for cable Ø 3,0 - 6,0 mm
- for cable Ø 4,5 - 9,0 mm
- for cable Ø 7,0 - 13,0 mm
- for cable Ø 10,0 - 17,0 mm
- for cable Ø 13,0 - 21,0 mm
- for cable Ø 17,0 - 28,0 mm
- for cable Ø 23,0 - 35,0 mm
- for cable Ø 34,0 - 48,0 mm

AW M12INX
AW M16INX
AW M20INX
AW M25INX
AW M32INX
AW M40INX
AW M50INX
AW M63INX

M 12
M 16
M 20
M 25
M 32
M 40
M 50
M 63

II 2 G Ex e IIC Gb

I 2 D Ex tb IIIC Db IP68

* to be used with metal lock nuts (page 14)

dimensions in mm

AW M..INX

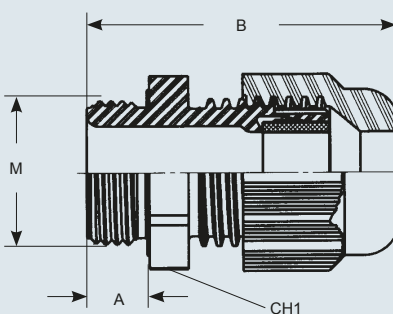

AW M..INX	A	B min	B max	CH
12	9,0	29,0	34,0	16,0
16	9,0	31,0	37,0	20,0
20	10,0	36,0	45,0	24,0
25	10,0	38,0	47,0	29,0
32	12,0	42,0	51,0	36,0
40	12,0	52,0	65,0	46,0
50	14,0	59,0	72,0	55,0
63	15,0	64,0	78,0	68,0

dimensions shown are not binding
and may be changed without notice

Rapid assembly and disassembly, without the use of tools

IP66 degree of protection
(according to EN 60529)

Fully insert the cable-guide
into the fitting

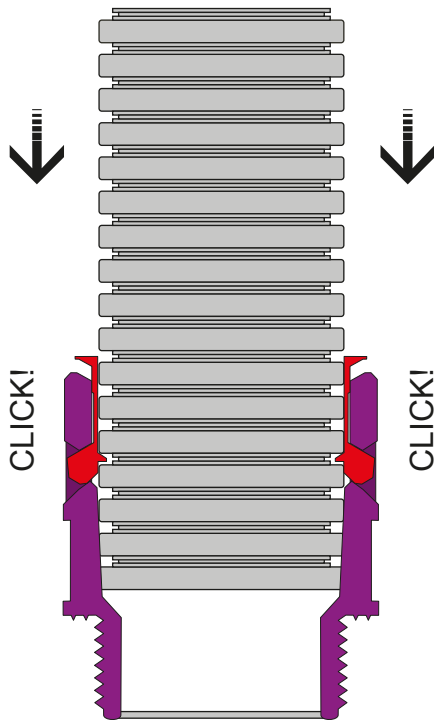

IP68 degree of protection
(according to EN 60529)

- Apply the O-ring gasket (AIR G) in the cable-guide's final section
- Fully insert the cable-guide into the fitting
- Place the gasket (AIR B) between the fitting and the support base

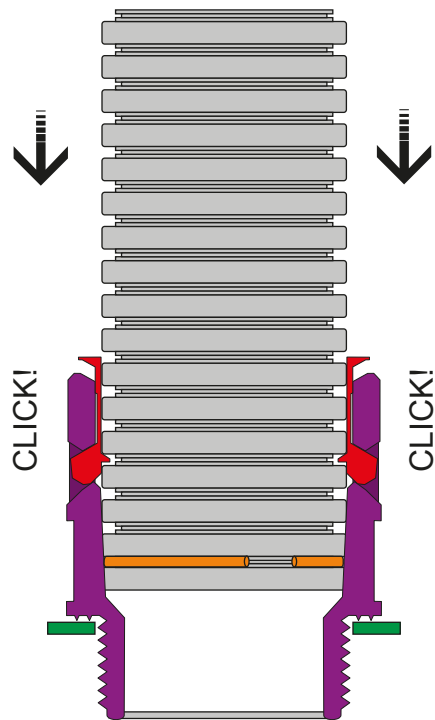

Disassembly

Keep the sealing ring of the fitting
pressed down and rotate to extract the
cable-guide

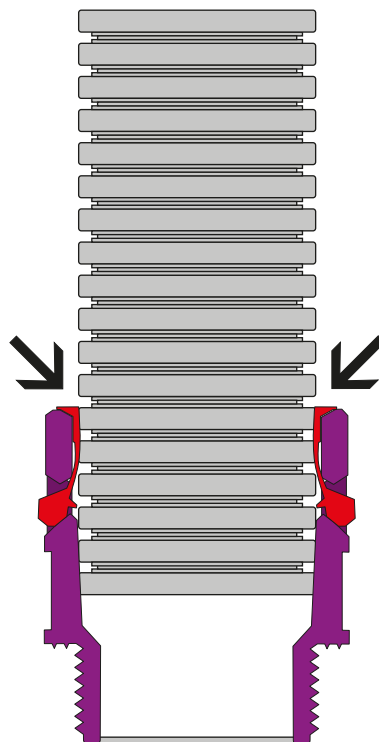

- ❶ Flexible, mechanically solid cable-guide with a special section patented for rapid assembly without the use of tools.
- ❷ Indication, on the fitting, of the nominal diameter of the cable-guide that may be inserted. Assembly without the use of accessories and tools.
- ❸ 12-sided edge to screw the fitting using a polygonal key.
- ❹ 6-sided edge to tighten the fitting using a forked key.
- ❺ Identification of the fitting's threading size.
- ❻ Pressure unblocking device. The cable-guide may be extracted from the fitting without the use of accessories and tools.
- ❼ Pull-resistant ring, which works along the entire perimeter of the cable-guide enabling effective discharge resistance.
- ❽ Fitting with conical internal walls to ensure an IP66 degree of protection (according to EN 60529).
- ❾ Fitting base formed by circular rings to ensure an IP66 degree of protection (according to EN 60529).
- ❿ IP68 degree of protection, obtainable by adding an O-ring gasket (AIR G) in the last cable-guide section and a gasket (AIR B) on the support base.

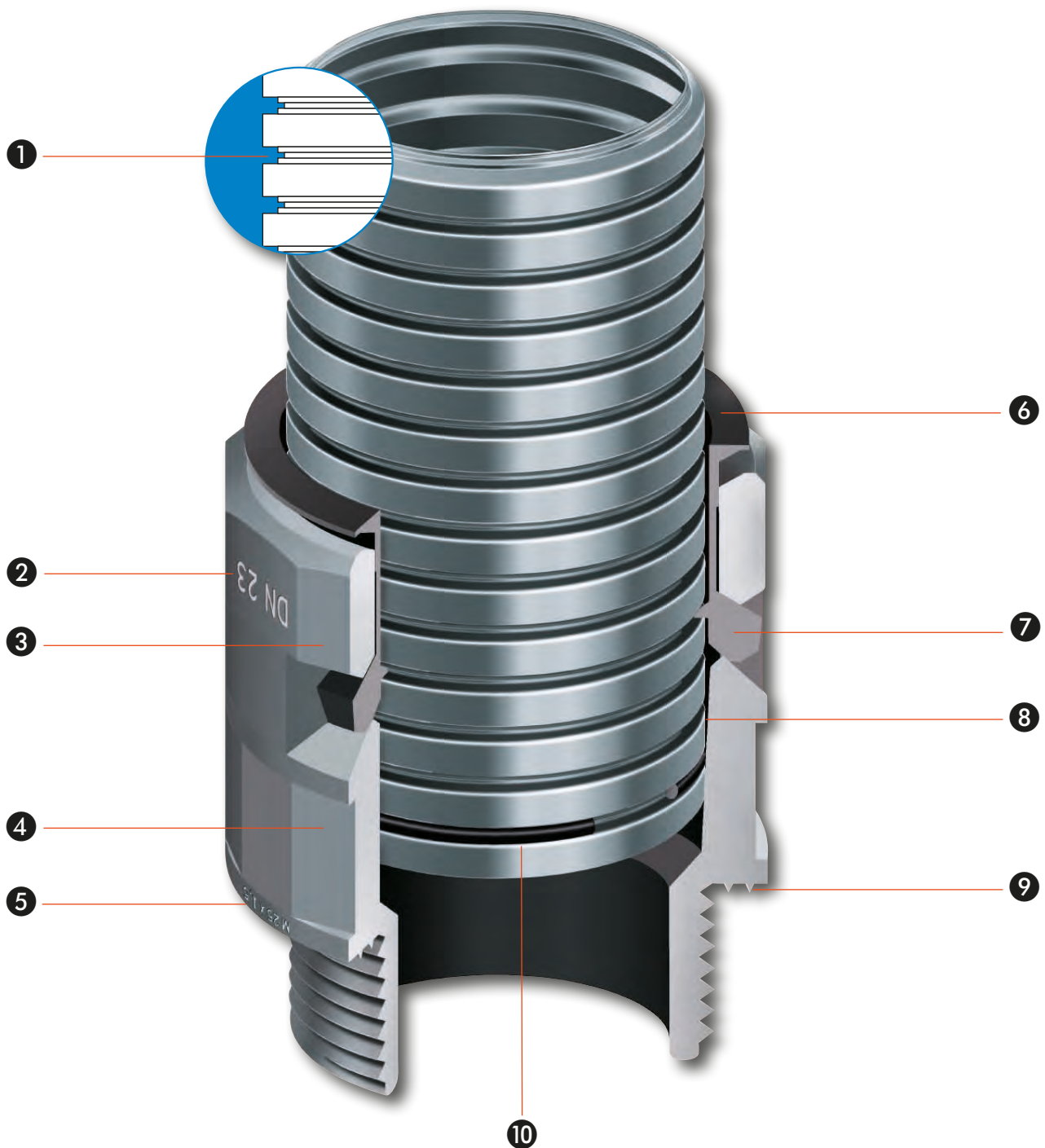



Composition of the part No.: e.g. **AI C 13 V 12 N**

article series _____
 metric or Pg threading _____
 threading size _____
 fitting version _____
 flexible tube nominal diameter _____
 black version component _____

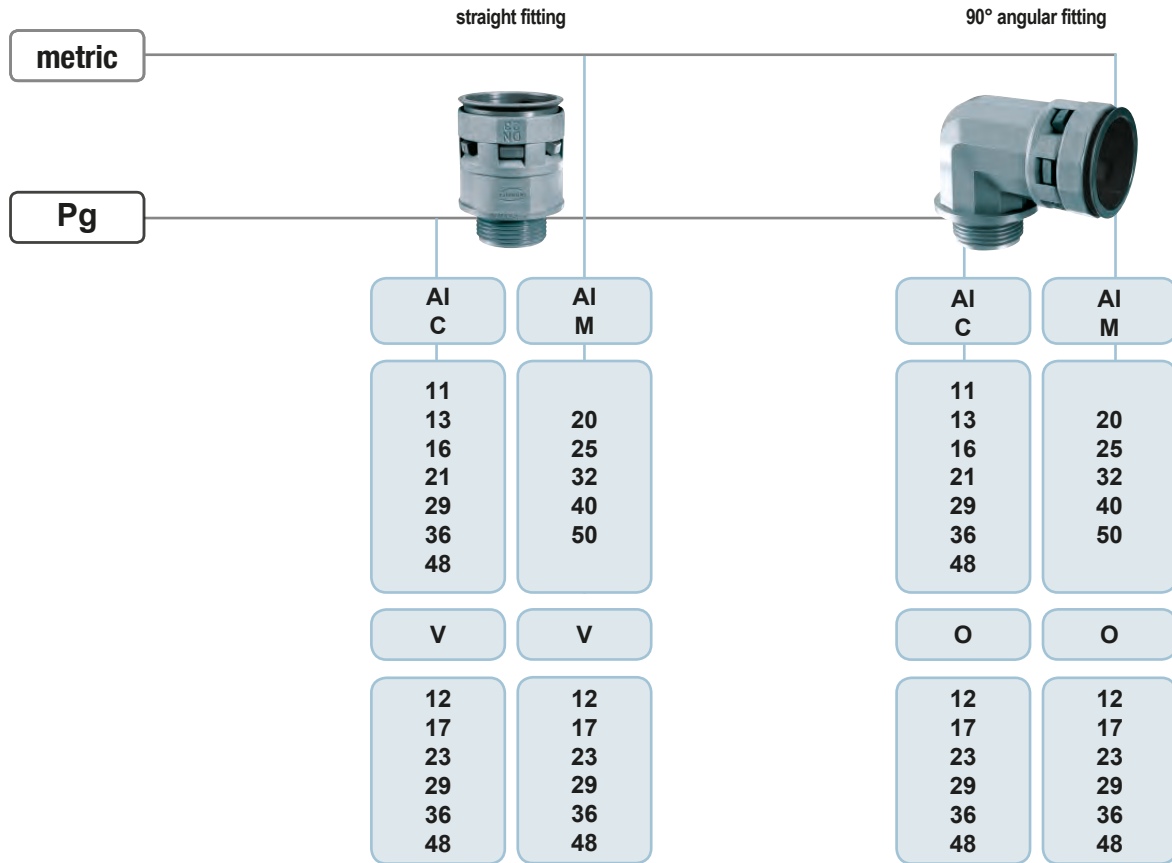

cable-guide support grey

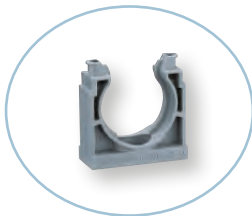

cable-guide support black

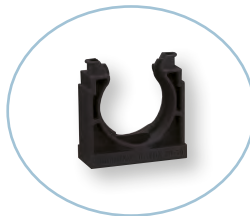

steel cable-guide support



gaskets for fitting base

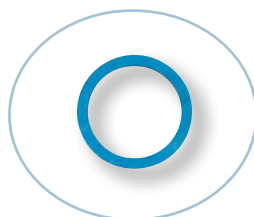

O-ring gaskets for flexible tubes

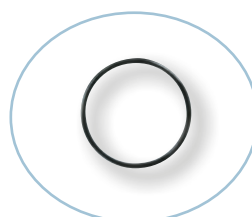

Technical characteristics of the tubes



flexible tube series	resistance to compression	shock resistance	resistance to traction	temperature limit			self-extinguishing UL 94 classification	resistance to glow-wire in line with IEC 60695 -2-1	certifications
				lower	upper	short term			
abbrev.									
AIT A..	>250 N	6 J	> 300 N	-40 °C	+105 °C	+150 °C	V2	850 °C	UL
AIT E..	>200 N	2 J	> 300 N	-40 °C	+105 °C	+140 °C	HB	750 °C	

Nominal diameter of the flexible tubes that may be inserted into the fittings (mm)

Pg threading							
fitting series	11	13,5	16	21	29	36	48
AI C.. V..	Ø 12	Ø 12-17	Ø 17	Ø 23	Ø 29	Ø 36	Ø 48
AI C.. O..	Ø 12	Ø 17	Ø 17	Ø 23	Ø 29	Ø 36	Ø 48

Metric threading					
fitting series	20	25	32	40	50
AI M.. V..	Ø 12-17	Ø 17-23	Ø 23-29	Ø 29-36	Ø 36-48
AI M.. O..	Ø 12-17	Ø 23	Ø 29	Ø 36	Ø 48



- fitting made of self-extinguishing PA6 polyamide without halogen, phosphorus and cadmium
- IP65 static and IP54 dynamic degree of protection (according to EN 60529)
- for IP68 (static use) or IP67 (dynamic use) degree of protection according to EN 60529, O-ring gaskets and gaskets for fitting base (page 26) shall be required
- temperature range -30 °C / +100 °C
- metric threading according to EN 60423
- Pg threading according to DIN 40430
- insertion and extraction of flexible tubes without the use of tools
- hexagonal base for tightening ease

straight fitting grey



straight fitting black



description	part No.	Pg or M threading	part No.	Pg or M threading
- for flexible tubes, nominal Ø 12 *	AI C11V12	Pg 11	AI C11V12N	Pg 11
- for flexible tubes, nominal Ø 12 *	AI C13V12	Pg 13,5	AI C13V12N	Pg 13,5
- for flexible tubes, nominal Ø 17 *	AI C13V17	Pg 13,5	AI C13V17N	Pg 13,5
- for flexible tubes, nominal Ø 17 *	AI C16V17	Pg 16	AI C16V17N	Pg 16
- for flexible tubes, nominal Ø 23 *	AI C21V23	Pg 21	AI C21V23N	Pg 21
- for flexible tubes, nominal Ø 29 *	AI C29V29	Pg 29	AI C29V29N	Pg 29
- for flexible tubes, nominal Ø 36 *	AI C36V36	Pg 36	AI C36V36N	Pg 36
- for flexible tubes, nominal Ø 48 *	AI C48V48	Pg 48	AI C48V48N	Pg 48
- for flexible tubes, nominal Ø 12 *	AI M20V12	M 20	AI M20V12N	M 20
- for flexible tubes, nominal Ø 17 *	AI M20V17	M 20	AI M20V17N	M 20
- for flexible tubes, nominal Ø 17 *	AI M25V17	M 25	AI M25V17N	M 25
- for flexible tubes, nominal Ø 23 * ¹⁾	AI M25V23	M 25	AI M25V23N	M 25
- for flexible tubes, nominal Ø 23 * ¹⁾	AI M32V23	M 32	AI M32V23N	M 32
- for flexible tubes, nominal Ø 29 * ¹⁾	AI M32V29	M 32	AI M32V29N	M 32
- for flexible tubes, nominal Ø 29 * ¹⁾	AI M40V29	M 40	AI M40V29N	M 40
- for flexible tubes, nominal Ø 36 * ¹⁾	AI M40V36	M 40	AI M40V36N	M 40
- for flexible tubes, nominal Ø 36 * ¹⁾	AI M50V36	M 50	AI M50V36N	M 50
- for flexible tubes, nominal Ø 48 * ¹⁾	AI M50V48	M 50	AI M50V48N	M 50

* UL mark with approval from the Underwriters Laboratories

- 1) for use with:
- lock nuts (page 12)
 - multipole connector enclosures CF/MF 6/10/16/24/32/48/50 (new version)
 - IP68 high protection multipole connector enclosures
 - BIG multipole connector enclosures

dimensions in mm

AI C..V / AI C..V..N - AI M..V / AI M..V..N

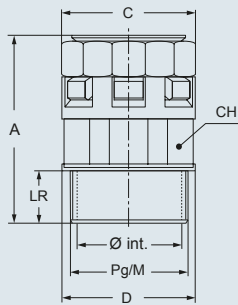

part No.	part No.	Pg	Ø int.	A	C	D	CH	LR
grey		black						
AI C11V12	AI C11V12N	11	14	37,5	26	25,5	20	11
AI C13V12	AI C13V12N	13,5	14	37,5	26	25,5	20	11
AI C13V17	AI C13V17N	13,5	14	44,5	31	28	27	11,5
AI C16V17	AI C16V17N	16	17	44,5	31	29	27	11,5
AI C21V23	AI C21V23N	21	22	48,5	37	36,5	34	12,5
AI C29V29	AI C29V29N	29	30	49,5	46	46	42	12,5
AI C36V36	AI C36V36N	36	37,5	55	54	56	50	14
AI C48V48	AI C48V48N	48	50	56	69	69,5	66	14

part No.	part No.	M	Ø int.	A	C	D	CH	LR
grey		black						
AI M20V12	AI M20V12N	20x1,5	14	37	26	25,5	20	11
AI M20V17	AI M20V17N	20x1,5	14,5	44	31	30	27	11
AI M25V17	AI M25V17N	25x1,5	18,5	45	31	34	27	12
AI M25V23	AI M25V23N	25x1,5	18,5	48	37	37	34	12
AI M32V23	AI M32V23N	32x1,5	25,5	51	37	42	34	15
AI M32V29	AI M32V29N	32x1,5	25,5	52	46	46	42	15
AI M40V29	AI M40V29N	40x1,5	32	56	46	52	42	16
AI M40V36	AI M40V36N	40x1,5	32	60	54	54	50	19
AI M50V36	AI M50V36N	50x1,5	42	60	54	62	50	19
AI M50V48	AI M50V48N	50x1,5	42	61	69	69	66	19

dimensions shown are not binding and may be changed without notice

- fitting made of self-extinguishing PA6 polyamide without halogen, phosphorus and cadmium
- IP65 static and IP54 dynamic degree of protection (according to EN 60529)
- for IP68 (static use) or IP67 (dynamic use) degree of protection according to EN 60529, O-ring gaskets and gaskets for fitting base (page 26) shall be required
- temperature range -30 °C / +100 °C
- metric threading according to EN 60423
- Pg threading according to DIN 40430
- insertion and extraction of flexible tubes without the use of tools
- hexagonal base for tightening ease

90° angular fitting grey



90° angular fitting black



description	part No.	Pg or M threading	part No.	Pg or M threading
- for flexible tubes, nominal Ø 12	AI C11O12	Pg 11	AI C11O12N	Pg 11
- for flexible tubes, nominal Ø 17	AI C13O17	Pg 13,5	AI C13O17N	Pg 13,5
- for flexible tubes, nominal Ø 17	AI C16O17	Pg 16	AI C16O17N	Pg 16
- for flexible tubes, nominal Ø 23	AI C21O23	Pg 21	AI C21O23N	Pg 21
- for flexible tubes, nominal Ø 29	AI C29O29	Pg 29	AI C29O29N	Pg 29
- for flexible tubes, nominal Ø 36	AI C36O36	Pg 36	AI C36O36N	Pg 36
- for flexible tubes, nominal Ø 48	AI C48O48	Pg 48	AI C48O48N	Pg 48
- for flexible tubes, nominal Ø 12	AI M20O12	M 20	AI M20O12N	M 20
- for flexible tubes, nominal Ø 17	AI M20O17	M 20	AI M20O17N	M 20
- for flexible tubes, nominal Ø 23	AI M25O23	M 25	AI M25O23N	M 25
- for flexible tubes, nominal Ø 29 ¹⁾	AI M32O29	M 32	AI M32O29N	M 32
- for flexible tubes, nominal Ø 36 ¹⁾	AI M40O36	M 40	AI M40O36N	M 40
- for flexible tubes, nominal Ø 48 ¹⁾	AI M50O48	M 50	AI M50O48N	M 50

1) for use with:

- lock nuts (page 12)
- multipole connector enclosures CF/MF 32/48/50
- IP68 high protection multipole connector enclosures
- BIG multipole connector enclosures

dimensions in mm

AI C..O / AI C..O..N - AI M..O / AI M..O..N

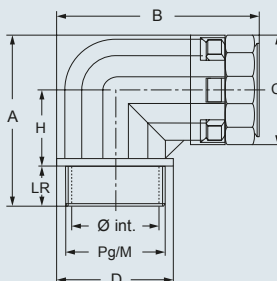

part No.	part No.	Pg	Ø int.	A	B	C	D	CH	LR
grey	black								
AI C11O12	AI C11O12N	11	14	39	45	25	25	15	11
AI C13O12	AI C13O12N	13,5	14	45	56,5	30	27	18	11,5
AI C16O17	AI C16O17N	16	17	45	57,5	30	29	18	11,5
AI C21O23	AI C21O23N	21	22	53	65,5	37	36,5	23	12,5
AI C29O29	AI C29O29N	29	30	65	76	45	46	28	12,5
AI C36O36	AI C36O36N	36	37,5	79	89,5	54	56	33	14
AI C48O48	AI C48O48N	48	50	92	103,5	68	69,5	39	14

part No.	part No.	M	Ø int.	A	B	C	D	CH	LR
grey	black								
AI M20O12	AI M20O12N	20x1,5	12,3	39	45,5	25	26	15	11
AI M20O17	AI M20O17N	20x1,5	14,5	45	58	30	30	18	11
AI M25O23	AI M25O23N	25x1,5	18,5	53	66	36,5	37	23	12
AI M32O29	AI M32O29N	32x1,5	25,5	66	76	45	46	27	15
AI M40O36	AI M40O36N	40x1,5	32	79	89	54	55	33	19
AI M50O48	AI M50O48N	50x1,5	42	92	103	68	69	39	19

dimensions shown are not binding and may be changed without notice

- fitting made of modified PA6 polyamide without halogen, phosphorus and cadmium
- resistant to UV rays (it is preferable to use the black version in the presence of UV rays)
- self-extinguishing V2 according to UL94
- resistance to 850 °C glow-wire according to IEC 60695-2-1
- temperature range -40 °C / +105 °C (short term: 150 °C)
- does not propagate flames, according to EN 50086-1
- insertion and extraction in the fitting without the use of tools
- ensuring the insulation and mechanical protection of cables

standard flexible tube grey

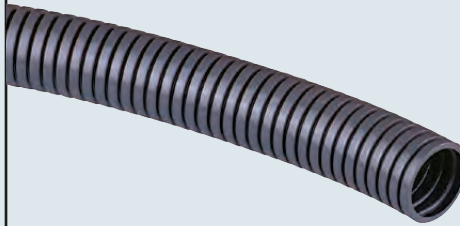

standard flexible tube black



description	part No.	part No.
- nominal Ø 12 *	AIT A12	AIT A12N
- nominal Ø 17 *	AIT A17	AIT A17N
- nominal Ø 23 *	AIT A23	AIT A23N
- nominal Ø 29 *	AIT A29	AIT A29N
- nominal Ø 36 *	AIT A36	AIT A36N
- nominal Ø 48 *	AIT A48	AIT A48N

* UL mark with approval from the Underwriters Laboratories

dimensions in mm

AIT A - AIT A..N

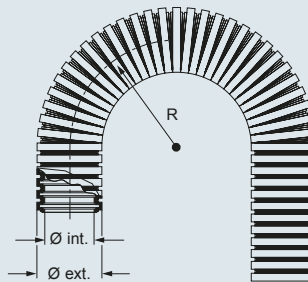

part No. grey	part No. black	Ø int.	Ø ext.	R minimum curving radius (static)	standard package (m)
AIT A12	AIT A12N	12,2	15,8	30	50
AIT A17	AIT A17N	16,8	21,2	40	50
AIT A23	AIT A23N	22,6	28,5	55	50
AIT A29	AIT A29N	28,3	34,5	65	50
AIT A36	AIT A36N	36,3	42,5	80	30
AIT A48	AIT A48N	47,4	54,5	95	30

dimensions shown are not binding and may be changed without notice

- fitting made of modified PA6 polyamide without halogen, phosphorus and cadmium
- self-extinguishing HB according to UL94
- resistance to 750 °C glow-wire according to IEC 60659-2-1
- temperature range -40 °C / +105 °C (short term: 140 °C)
- does not propagate flames according to IEC 50086
- insertion and extraction in the fitting without the use of tools
- ensuring the insulation and mechanical protection of cables

light flexible tube grey

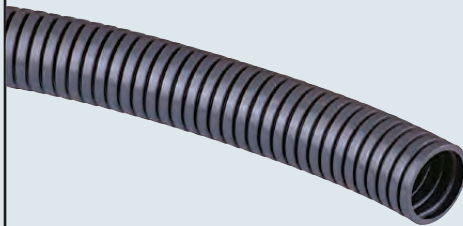

light flexible tube black



description	part No.	part No.
- nominal Ø 12	AIT E12	AIT E12N
- nominal Ø 17	AIT E17	AIT E17N
- nominal Ø 23	AIT E23	AIT E23N
- nominal Ø 29	AIT E29	AIT E29N
- nominal Ø 36	AIT E36	AIT E36N
- nominal Ø 48	AIT E48	AIT E48N

dimensions in mm

AIT E - AIT E..N

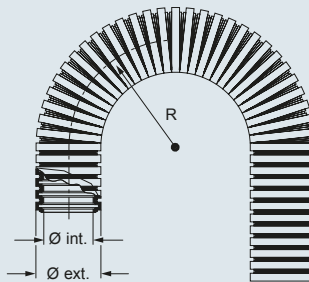

part No. grey	part No. black	Ø int.	Ø ext.	R minimum curving radius (static)	standard package (m)
AIT E12	AIT E12N	12,2	15,8	30	50
AIT E17	AIT E17N	16,8	21,2	40	50
AIT E23	AIT E23N	22,6	28,5	55	50
AIT E29	AIT E29N	28,4	34,5	65	50
AIT E36	AIT E36N	36,4	42,5	80	30
AIT E48	AIT E48N	47,5	54,5	95	30

dimensions shown are not binding
and may be changed without notice

- made of modified PA6 polyamide
- without halogen, phosphorus and cadmium
- self-extinguishing
- temperature range -30 °C / +100 °C
- shock resistant
- for fixing cable-guides to the wall

cable-guide support grey

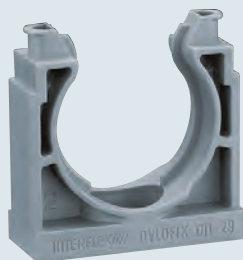

cable-guide support black



description

- nominal Ø 12
- nominal Ø 17
- nominal Ø 23
- nominal Ø 29
- nominal Ø 36
- nominal Ø 48

part No.

AIR D12
AIR D17
AIR D23
AIR D29
AIR D36
AIR D48

part No.

AIR D12N
AIR D17N
AIR D23N
AIR D29N
AIR D36N
AIR D48N

dimensions in mm

AIR D - AIR D..N

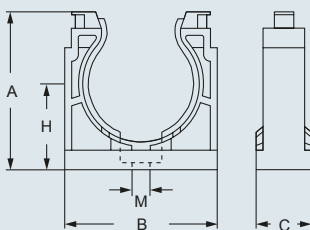

part No.	part No.	A	B	C	H	M
grey	black					
AIR D12	AIR D12N	26,5	25	20	15,5	M 5
AIR D17	AIR D17N	32,5	32	20	18,5	M 5
AIR D23	AIR D23N	41	40	20	23	M 6
AIR D29	AIR D29N	47	46	20	26	M 6
AIR D36	AIR D36N	57,5	56	20	32	M 6
AIR D48	AIR D48N	70,5	70	20	39	M 6

dimensions shown are not binding
and may be changed without notice

AIR Z:

- made of galvanised steel
- with elastomer protection
- resistant to traction, shock and corrosion
- for fixing cable-guides to the wall

steel cable-guide support



description

part No.

- steel supports
- nominal Ø 12
 - nominal Ø 17
 - nominal Ø 23
 - nominal Ø 29
 - nominal Ø 36
 - nominal Ø 48

- AIR Z12**
AIR Z17
AIR Z23
AIR Z29
AIR Z36
AIR Z48

dimensions in mm

AIR Z

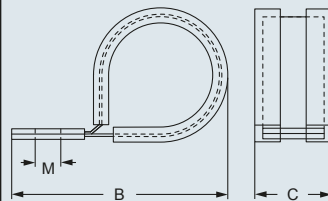

part No.	B	C	M
AIR Z12	29	12	M 4
AIR Z17	39	16	M 5
AIR Z23	47	16	M 5
AIR Z29	60	19	M 6
AIR Z36	70	19	M 6
AIR Z48	85	19	M 6

dimensions shown are not binding
and may be changed without notice

AIR B:

- used between the fitting and a flat surface, it guarantees IP68 degree of protection according to EN 60529
- temperature range -40 °C / +200 °C

AIR G:

- O-ring gasket in NBR 70
- temperature range -30 °C / +100 °C
- inserted in flexible tubes, it guarantees IP68 degree of protection according to EN 60529

gaskets for fitting base

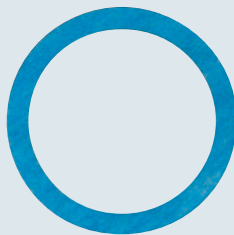

O-ring gaskets for flexible tubes

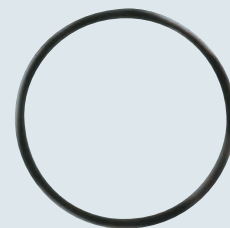

description	part No.	Pg or M threading	part No.
- for Pg 11 fittings	AIR B11	Pg 11	
- for Pg 13,5 fittings	AIR B13	Pg 13,5	
- for Pg 16 fittings	AIR B16	Pg 16	
- for Pg 21 fittings	AIR B21	Pg 21	
- for Pg 29 fittings	AIR B29	Pg 29	
- for Pg 36 fittings	AIR B36	Pg 36	
- for Pg 48 fittings	AIR B48	Pg 48	
- for M 20 fittings	AIR B20	M 20	
- for M 25 fittings	AIR B25	M 25	
- for M 32 fittings	AIR B32	M 32	
- for M 40 fittings	AIR B40	M 40	
- for M 50 fittings	AIR B50	M 50	
O-ring gasket			AIR G12
- nominal Ø 12			AIR G17
- nominal Ø 17			AIR G23
- nominal Ø 23			AIR G29
- nominal Ø 29			AIR G36
- nominal Ø 36			AIR G48
- nominal Ø 48			

dimensions in mm

AIR B

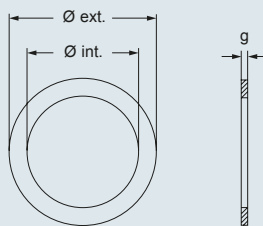

part No.	Pg	Ø int.	Ø ext.	g
AIR B13	11	18,6	26	1,5
AIR B13	13,5	20,4	29	1,5
AIR B16	16	22,5	33	1,5
AIR B21	21	28,3	39	1,5
AIR B29	29	37	49	1,5
AIR B36	36	47	59	1,5
AIR B48	48	59,3	71	1,5

part No.	M	Ø int.	Ø ext.	g
AIR B20	20x1,5	20	27	1,5
AIR B25	25x1,5	25	35	1,5
AIR B32	32x1,5	32	43	1,5
AIR B40	40x1,5	40	55	1,5
AIR B50	50x1,5	50	69	1,5

dimensions shown are not binding
and may be changed without notice

ASR B:

- used between the fitting and a flat surface, it guarantees IP68 degree of protection according to EN 60529
- temperature range -40 °C / +100 °C

ARG:

- O-ring gasket in NBR
- temperature range -25 °C / +120 °C
- used between the fitting and a flat surface, it guarantees IP68 degree of protection according to EN 60529

gaskets for fitting base



O-ring gaskets

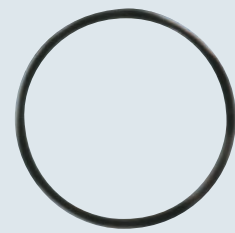

description	part No.	Pg or M threading	part No.	Pg or M threading
- for Pg 11 fittings - for Pg 13,5 fittings - for Pg 16 fittings - for Pg 21 fittings - for Pg 29 fittings - for Pg 36 fittings - for Pg 42 fittings	ASR B11 ASR B13 ASR B16 ASR B21 ASR B29 ASR B36 ASR B42	Pg 11 Pg 13,5 Pg 16 Pg 21 Pg 29 Pg 36 Pg 42		
- for M 20 fittings - for M 25 fittings - for M 32 fittings - for M 40 fittings - for M 50 fittings	ASR B20 ASR B25 ASR B32 ASR B40 ASR B50	M 20 M 25 M 32 M 40 M 50		
O-ring gasket - for Pg 11 and M 20 fittings - for Pg 13,5 fittings - for Pg 16 fittings - for Pg 21 fittings - for Pg 29 fittings - for Pg 36 fittings - for Pg 42 fittings			ARG 11/20 ARG 13 ARG 16 ARG 21 ARG 29 ARG 36 ARG 42	Pg 11 - M 20 Pg 13,5 Pg 16 Pg 21 Pg 29 Pg 36 Pg 42
O-ring gasket - for M 25 fittings - for M 32 fittings - for M 40 fittings - for M 50 fittings			ARG 25 ARG 32 ARG 40 ARG 50	M 25 M 32 M 40 M 50

dimensions in mm

ASR B

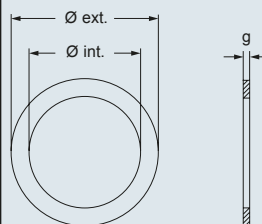

part No.	Pg	Ø int.	Ø ext.	g
ASR B11	11	17,1	23	1,2
ASR B13	13,5	19	25	1,2
ASR B16	16	21	27	1,2
ASR B21	21	26,6	34	1,5
ASR B29	29	35,2	45	1,5
ASR B36	36	45,2	56	1,5
ASR B42	42	52,2	67	1,5

part No.	M	Ø int.	Ø ext.	g
ASR B20	20	18	24	1,2
ASR B25	25	23	30	1,2
ASR B32	32	30	40	1,5
ASR B40	40	38	48	1,5
ASR B50	50	48	58	1,5

dimensions in mm

ARG

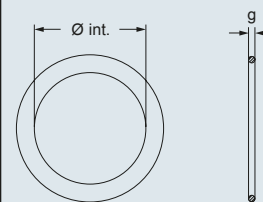

part No.	Pg	Ø int.	g
ARG 11/20	11	17,17	1,78
ARG 13	13,5	18,77	1,78
ARG 16	16	20,35	1,78
ARG 21	21	26,65	2,62
ARG 29	29	36,14	2,62
ARG 36	36	45,69	2,62
ARG 42	42	52,07	2,62

part No.	M	Ø int.	g
ARG 11/20	20	17,17	1,78
ARG 25	25	21,95	1,78
ARG 32	32	29,82	2,62
ARG 40	40	37,77	2,62
ARG 50	50	47,3	2,62

dimensions shown are not binding and may be changed without notice

Headquarters**ILME S.p.A.**

Via Marco Antonio Colonna, 9
20149 Milano - Italy
T +39 02345605.22 - F +39 02331058.13
www.ilme.com

France**ILME FRANCE S.A.R.L.**

Rue Roland Garros
Parc d'Activités de l'Aéroport
42160 Andrézieux-Bouthéon
T +33 (0) 4 77 36 23 36 - F +33 (0) 4 77 36 97 97
ilme-france@ilme.fr
www.ilme.fr

Germany**ILME GmbH**

Max-Planck-Straße 12
51674 Wiehl
T +49 (0)2261 - 7955-0 - F +49 (0)2261 - 7955-5
technik@ilme.de
www.ilme.de

**Sweden
and Nordic Countries****ILME NORDIC AB**

Transportvägen 18
24642 Löddeköpinge
T +46 46 18 28 00 - F +46 46 18 28 10
info@ilme.se
www.ilme.se

United Kingdom**ILME UK LIMITED**

50 Evans Road, Venture Point
Speke, Merseyside L24 9PB
T +44 (0) 151 3369321 - F +44 (0) 151 3369326
sales@ilmeuk.co.uk
www.ilmeuk.co.uk

China**ILME CHINA CO. LTD.**

Room 307, D area, No. 245,
Xin Jun Huan Road, MinHang Dis
201114 Shanghai
T +86 21 6248 9961 - F +86 21 3478 8067
info@ilmechina.com
www.ilmechina.com

Japan**ILME JAPAN CO. LTD.**

Kobe International Business Center - 650-0047, 5-2, 5 - Chome,
Minatojima Minami-Machi - Chuo-Ku, Kobe
T +81 7830 22005 - F +81 7830 22060
info@ilmejapan.co.jp
www.ilme.jp

www.ilme.com

XDG AS 1219



Catalogues

X-ON Electronics

Largest Supplier of Electrical and Electronic Components

Click to view similar products for [Enclosures, Boxes & Cases](#) category:

Click to view products by [ILME](#) manufacturer:

Other Similar products are found below :

[585-R-WH-PK](#) [M-10-PLATED](#) [60566-01-000](#) [HPL-9VB BATT DOOR](#) [61000-510-000](#) [C-23 Black Kit](#) [M18-PLTD](#) [M-21-PLATED](#) [63049-501-039](#) [CM5-125 Bone Prod. Unit](#) [63310-01-000](#) [6711GSKT](#) [71884-29-028](#) [LH45-100 Black](#) [72868-510-000](#) [CNS-0000 Black](#) [72883-510-000](#) [CNS-0101 Black](#) [72906-510-000](#) [CNS-0407 Black](#) [73092-510-000](#) [CNM-0101 Black](#) [73105-510-000](#) [CNL-0101 Black](#) [73108-510-000](#) [CNL-0303 Black](#) [73395-510-039](#) [CNS-0006 Bone](#) [74257-510-000](#) [CNL-0004](#) [MDC-1183-PLAIN-ALUM](#) [MDC-1183-PTD](#) [MDC-13104-PTD](#) [MDC-973-PTD](#) [76](#) [77153-01-028](#) [FLX6030](#) [83535-01-508](#) [90026-501-000](#) [PS36-200](#) [116-508](#) [120-407](#) [120-910](#) [127-908](#) [130-008](#) [1301170079](#) [1322GSKTEP](#) [1325GSKT3](#) [138-PLAIN](#) [1434-1210](#) [1804RP-RB-PK](#) [190-005](#) [2202307](#) [KAB3321 BLACK](#) [KAB3421](#) [2697466](#) [S52213](#) [2901123](#) [2901699](#) [A0645271](#) [A20P20](#) [2106-IR](#) [PERF-850-PLN](#)