

# Cable glands, fittings and flexible conduits

ENGLISH

2017

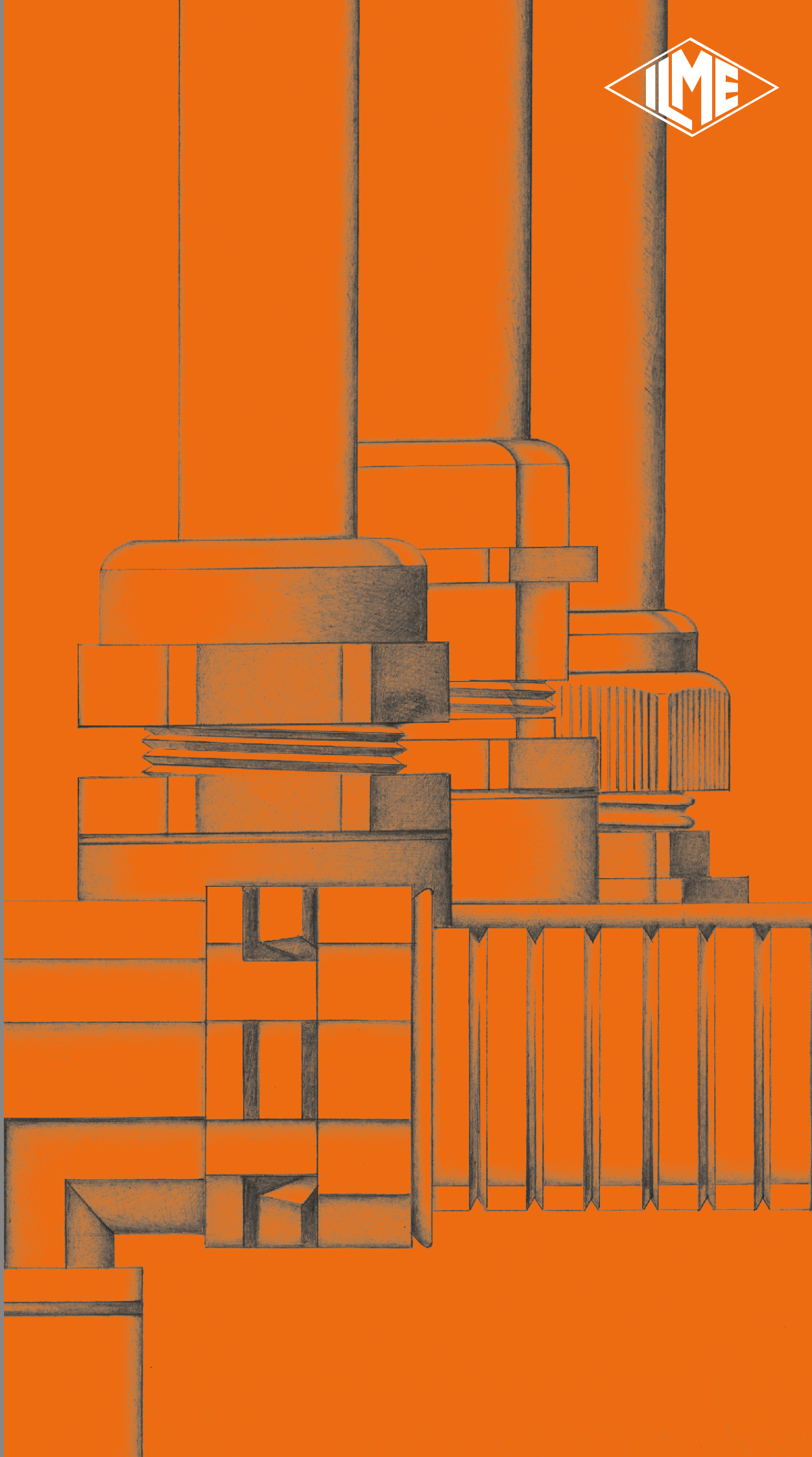

## The company and the product

I.L.M.E. SpA - **INDUSTRIA LOMBARDA MATERIALE ELETTRICO** - has been operating in **Milan since 1938**, in particular in the electrotechnical sector for the manufacture of equipment for industrial installations. ILME reflects the traditional **entrepreneurial spirit of Lombardy**, and has enjoyed continuous expansion for over half a century. The company has carved an important role for itself in the principal world markets, also operating directly in the countries that have assumed world leadership in the field of automation, including Germany and Japan. In the **electrical connection** sector with applications in industrial automation, characterised by **top performance** and utmost **reliability** needs, ILME is today the acknowledged partner of many leading companies worldwide.



The company's fundamental values are: **Product innovation**, original solutions, excellent **price-quality ratio**, a customer-oriented **service**, ethical behaviour and respect for the environment.

To promote the continuing improvement of its qualitative **results**, ILME has always encouraged its collaborators to work with maximum **responsibility and participation**.

The company focuses on a series of benefits to the user, including research into the most suitable materials, high quality and safe cabling, a rapid turnaround and readily available services.

## CE marking

As from 1<sup>st</sup> January 1997, in order to launch electrical products on the European market the manufacturer must ensure these bear the relevant CE marking, in line with the Low Voltage Directive 73/23/ EEC \* (implemented in Italy as L. D. 18-10-1977 no. 791) and its modification 93/68/EEC \* (implemented in Italy as L.D. 25-11-1996 no. 626/96, published in the supplement to the Gazzetta Ufficiale of 14-12-1996).

The CE marking must be visible on the product or, if this is not possible, on the packaging, the instructions for use or on the warranty certificate. It acts as a declaration by the manufacturer that the product complies with all relevant EU directives regarding its field of application.

### ILME products bear the CE marking on the actual product or its packaging.

Almost all ILME products fall within the scope of the Low Voltage Directive. A declaration of conformity is required in order to be able to apply the CE marking. This declaration, to which the market is not directly entitled, must be made available to the controlling authorities (in Italy, the Ministry for Industry, Commerce and Handicraft) at all times. In it, the manufacturer declares the technical safety standard(s) followed in the manufacture of the product. These standards must be, in decreasing order of preference:

- a European standard (EN prefix)
- a European harmonisation document (HD prefix)
- an international IEC standard
- a national standard
- in the absence of reference standards, the manufacturer's internal specifications guaranteeing compliance with the basic safety requirements of the directive.

Compliance with harmonised technical standards (i.e. ratified by CENELEC) also constitutes presumption of compliance with the basic safety requirements of the directives.

The CE marking of ILME products results from the declaration of conformity of the product to harmonised standards or international IEC standards.

Through the CE marking, ILME declares full compliance, not merely with the directive's basic safety requirements, but also with those international or national EU standards on which voluntary safety certification markings are based (e.g. IMQ and VDE). In this way, ILME intends to give the CE marking the value of self-certification in terms of safety, given the loss in legal value of voluntary certifications issued by third parties, ratified by directive 93/68/EEC\*.

Notwithstanding the above, practically all ILME products still bear voluntary conformity markings.

**The above mentioned EU declaration of conformity becomes null and void when the assembly of products includes one or more components not manufactured by ILME and without CE marking.**

**\*Note:** The next legal reference for the Low Voltage Directive was 2006/95/EC, as consolidation of the original Directive 73/23/EEC + Directive 93/68/EEC. On 29<sup>th</sup> March 2014, the Official Journal of the European Union published the new Low Voltage directive 2014/35/EU dd. 26<sup>th</sup> February 2014, a recast version of directive 2006/95/EC, which is in force since on 20<sup>th</sup> April 2016.

The information contained in this catalogue is not binding and may be changed without notice.



UNI EN ISO 9001: 2015  
Design, manufacture and distribution  
of industrial electrical equipment (IAF 19)  
Certificate N° 50 100 11133

Composition of the part No.: e.g. **AS C 11 P**

article series \_\_\_\_\_  
 metric or Pg threading \_\_\_\_\_  
 threading size \_\_\_\_\_  
 version \_\_\_\_\_

**Metal cable glands**

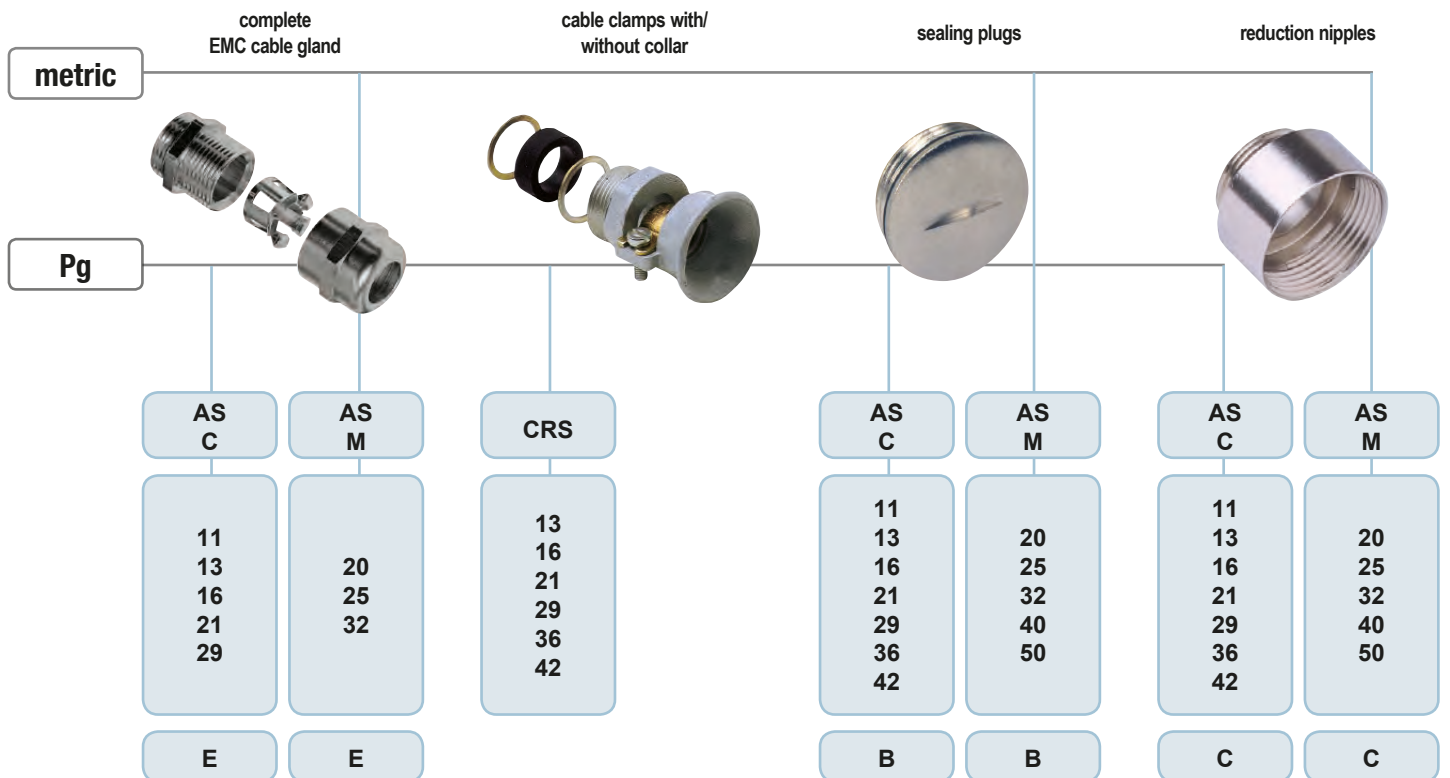
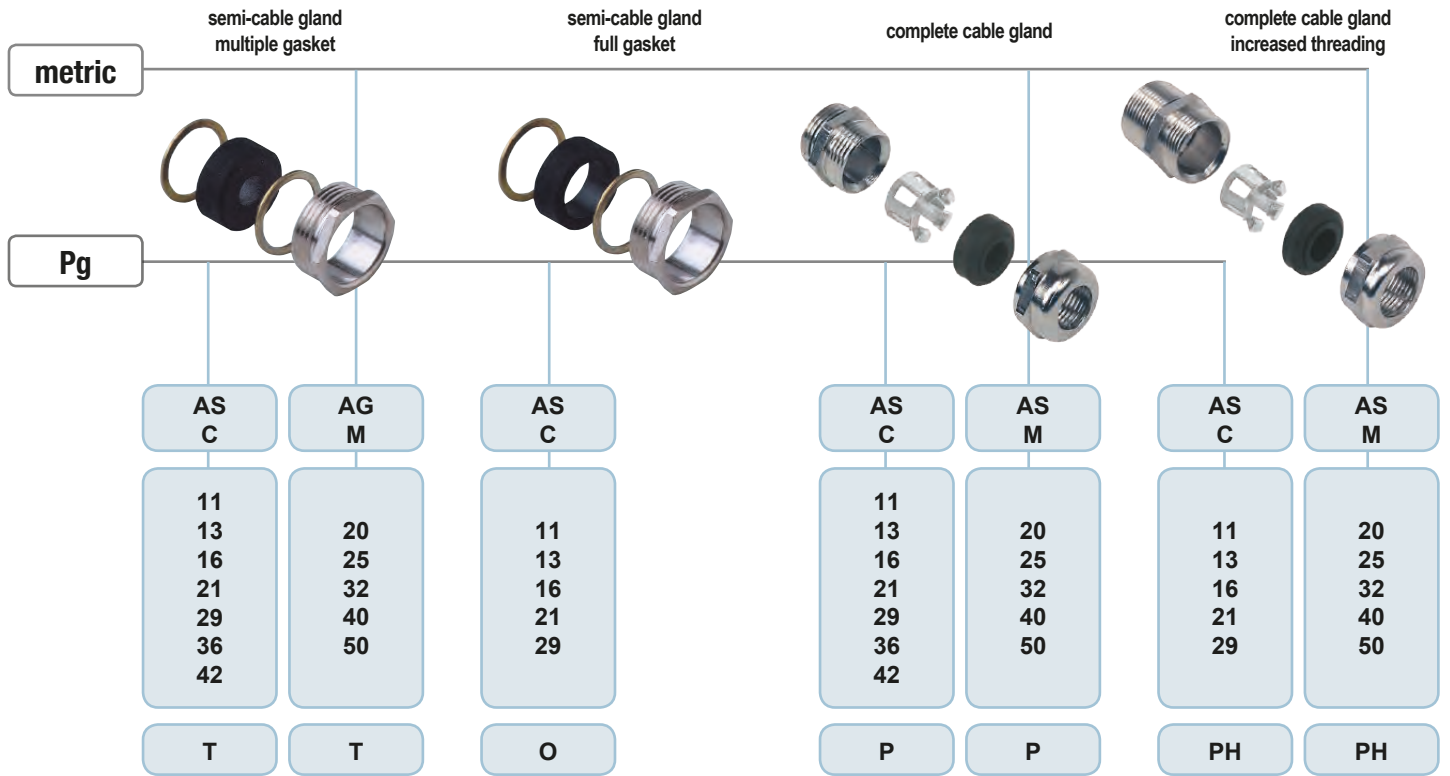

Composition of the part No.: e.g. **AS M 20 P**

article series \_\_\_\_\_  
 metric or Pg threading \_\_\_\_\_  
 threading size \_\_\_\_\_  
 version \_\_\_\_\_

**Insulating cable glands**

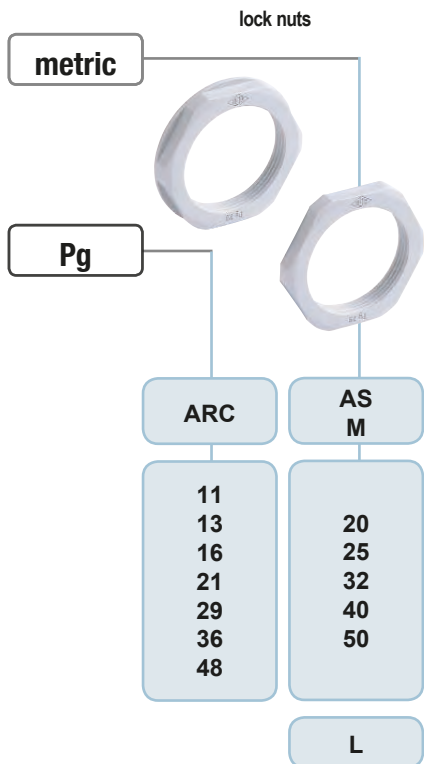
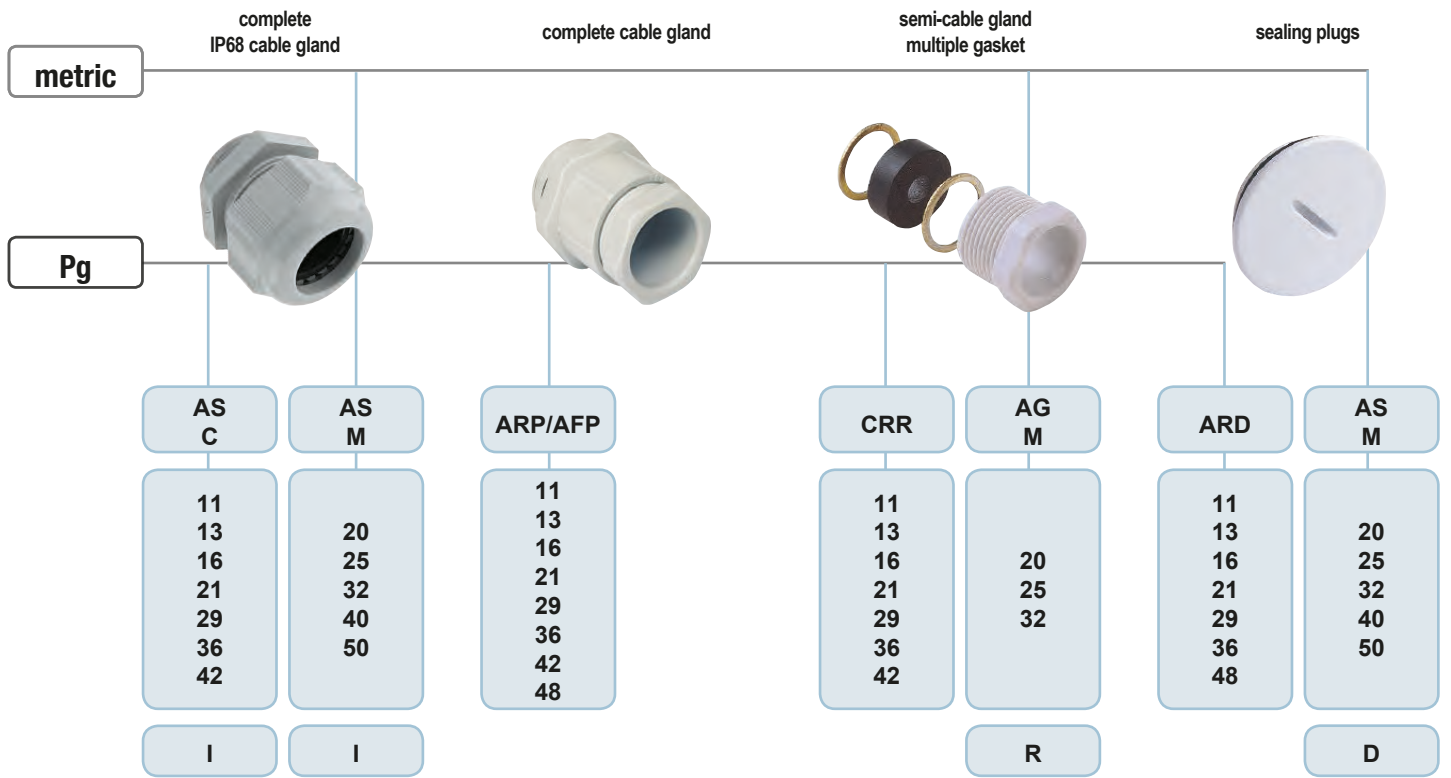

Composition of the part No.: e.g. **AW M 20 PHX**

article series \_\_\_\_\_  
 metric or Pg threading \_\_\_\_\_  
 threading size \_\_\_\_\_  
 version \_\_\_\_\_

**Metal cable glands**

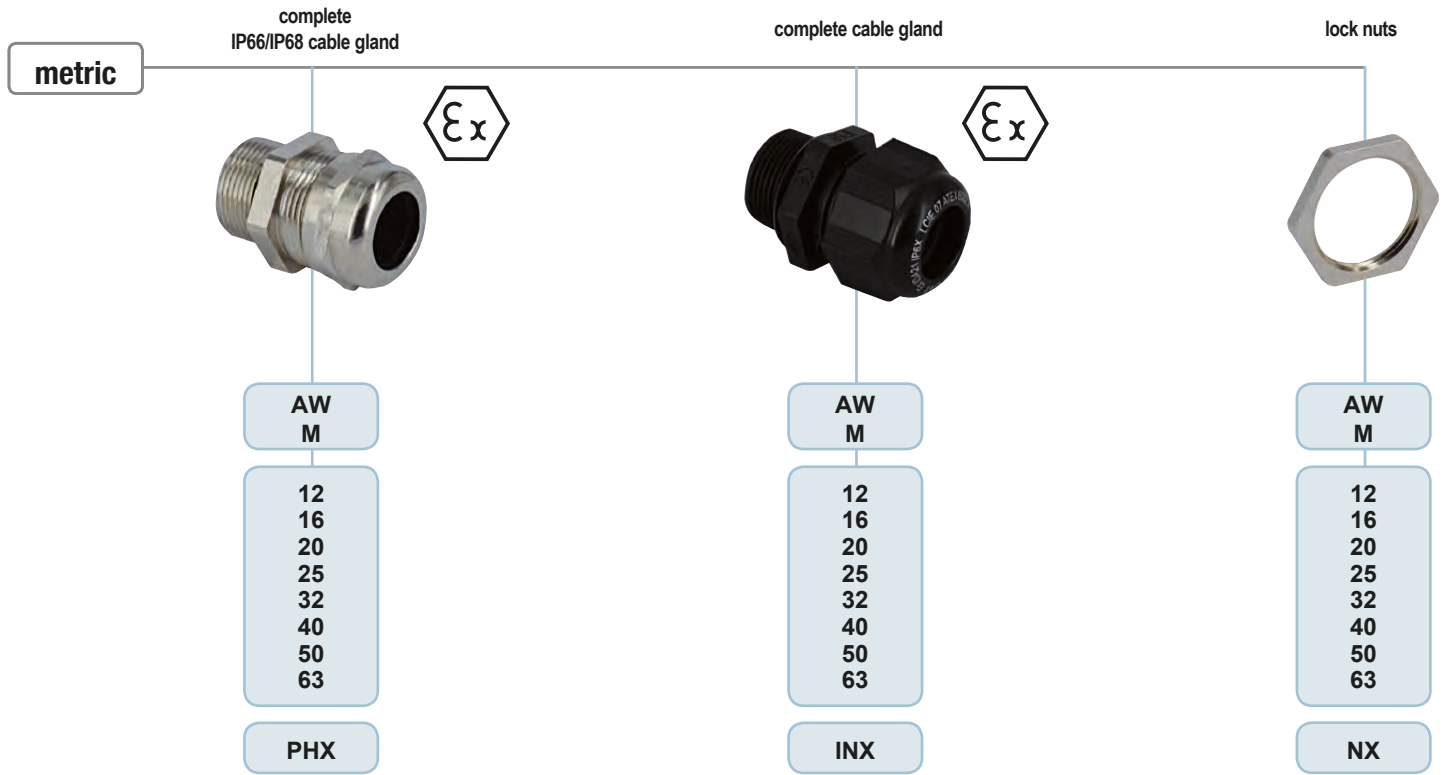

**Diameter of cables that may be used with cable glands**

**Pg threading**

Ø in mm

series	11	13,5	16	21	29	36	42	48
AS C..P	from 5 to 10,5	from 6 to 12,5	from 7 to 14,5	from 10 to 18	from 14 to 24	from 23 to 30	from 26 to 35	
AS C..PH	from 5 to 10,5	from 6 to 12,5	from 7 to 14,5	from 10 to 18	from 14 to 24			
AS C..E	from 7 to 10,5	from 8 to 12,5	from 10 to 14,5	from 13,5 to 18	from 17 to 24	from 24 to 30		
CRS..		12	14	18	25	32	38	
CRS..C *			7,5-10-12,5-15	10-13-16-19				
AS C..O	9	11	13	16	25			
AS C..T	7,5-10	7,5-10-12,5	7,5-10-12,5-15	10-13-16-19	18-21-24-27	24-27-30-33	30-33-36-39	
AS C..I	from 3,5 to 10	from 5 to 12	from 7 to 14	from 9 to 18	from 14 to 25	from 18 to 32	from 24 to 38,5	
AFPI/ARP	7,5-10-12,5	7,5-10-12,5	7,5-10-12,5-15	10-13-16-19	18-21-24-27	24-27-30-33	30-33-36-39	36-39-42-45
CRR..	5-7,5-10-12,5	7,5-10-12,5	7,5-10-12,5-15	10-13-16-19	18-21-24-27	24-27-30-33	30-33-36-39	

\*Kit with multiple gasket

**Metric threading**

Ø in mm

series	12	16	20	25	32	40	50	63
AS M..P			from 6 to 12,5	from 10 to 18	from 14 to 24	from 15 to 24	from 23 to 30	
AS M..PH			from 6 to 12,5	from 10 to 18	from 14 to 24	from 15 to 24	from 23 to 30	
AS M..E			from 8 to 12,5	from 13,5 to 18	from 17 to 24	from 24 to 30		
AG M..T			7 -10-13	11-14-17	19-21-24	26-29-32	35-38-41	
AG M..I			from 5 to 12,5	from 9 to 18	from 14 to 25	from 18 to 32	from 24 to 38,5	
AG M..R			7-10-13	11-14-17	19-21-24			
AW M..PHX	from 4,0 to 7,0	from 5,0 to 10,0	from 6,0 to 13,0	from 10,0 to 17,0	from 13,0 to 21,0	from 16,0 to 28,0	from 21,0 to 35,0	from 34,0 to 48,0
AW M..INX	from 3,0 to 6,0	from 4,5 to 9,0	from 7,0 to 13,0	from 10,0 to 17,0	from 13,0 to 21,0	from 17,0 to 28,0	from 23,0 to 35,0	from 34,0 to 48,0

# AS metal cable glands



- IP68 degree of protection (EN 60529)
- temperature range -25 °C / +120 °C
- metric threading according to EN 60423 and EN 62444
- Pg threading according to DIN 40430 and DIN 46320
- anti-aging rubber gaskets
- Pg 36/42 - M40/50 cable glands temperature range -30 °C / +95 °C
- long thread with temperature range -40 °C / +100 °C

## complete cable gland in nickel-plated brass



## complete cable gland in nickel-plated brass long\*



description	part No.	Pg or M threading	part No.	Pg or M threading
- for cable Ø 6 - 10 mm	<b>AS C11P</b>	Pg 11	<b>AS C11PH</b>	Pg 11
- for cable Ø 8 - 12 mm	<b>AS C13P</b>	Pg 13,5	<b>AS C13PH</b>	Pg 13,5
- for cable Ø 9,5 - 14 mm	<b>AS C16P</b>	Pg 16	<b>AS C16PH</b>	Pg 16
- for cable Ø 11,5 - 18 mm	<b>AS C21P</b>	Pg 21	<b>AS C21PH</b>	Pg 21
- for cable Ø 15 - 24 mm	<b>AS C29P</b>	Pg 29	<b>AS C29PH</b>	Pg 29
- for cable Ø 23 - 30 mm	<b>AS C36P</b>	Pg 36		
- for cable Ø 26 - 35 mm	<b>AS C42P</b>	Pg 42		
- for cable Ø 8 - 12 mm	<b>AS M20P</b>	M 20	<b>AS M20PH</b>	M 20
- for cable Ø 11,5 - 18 mm	<b>AS M25P</b>	M 25	<b>AS M25PH</b>	M 25
- for cable Ø 15 - 24 mm	<b>AS M32P</b>	M 32	<b>AS M32PH</b>	M 32
- for cable Ø 15 - 24 mm	<b>AS M40P</b>	M 40	<b>AS M40PH</b>	M 40
- for cable Ø 23 - 30 mm	<b>AS M50P</b>	M 50	<b>AS M50PH</b>	M 50

\*for use with:

- metal lock nuts (page 9)
- multipole connector enclosures CF/MF 6/10/16/24/32/48/50 (new version)
- IP68 high protection multipole connector enclosures
- BIG enclosures

dimensions in mm

### AS C..P - AS M..P

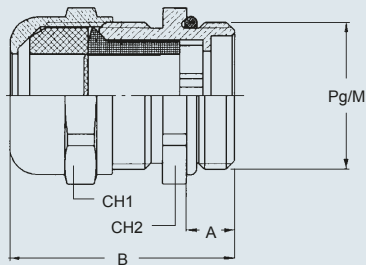

AS C..P	A	B	CH1	CH2
11	6	26	20	20
13,5	6,5	28	22	22
16	6,5	30	24	24
21	7	35	30	30
29	8	43	40	40
36	9	50	50	50
42	10	57	58	58

AS M..P	A	B	CH1	CH2
20	7	29	22	22
25	8	37	30	30
32	8,5	45	40	40
40	8,5	45	40	42
50	9,5	51	50	55

dimensions in mm

### AS C..PH - AS M..PH

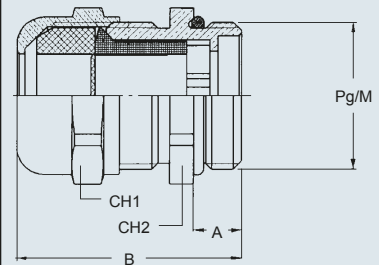

AS C..PH	A	B	CH1	CH2
11	15	35	20	20
13,5	15	36,5	22	22
16	15	38,5	24	24
21	15	43	30	30
29	15	50	40	40

AS M..PH	A	B	CH1	CH2
20	13	35	22	22
25	14	43	30	30
32	14,5	51	40	40
40	14,5	51	40	42
50	15,5	57	50	55

dimensions shown are not binding and may be changed without notice

- IP68 class of protection (EN 60529)
- temperature range -25 °C / +120 °C
- metric threading according to EN 60423 and EN 62444
- Pg threading according to DIN 40430 and DIN 46320
- anti-aging rubber internal gasket
- screening hold system

## complete EMC cable gland in nickel-plated brass



description	part No.	Pg or M threading
- for cable Ø 7 - 10,5 mm	<b>AS C11E</b>	Pg 11
- for cable Ø 8 - 12,5 mm	<b>AS C13E</b>	Pg 13,5
- for cable Ø 10 - 14,5 mm	<b>AS C16E</b>	Pg 16
- for cable Ø 13,5 - 18 mm	<b>AS C21E</b>	Pg 21
- for cable Ø 17 - 24 mm	<b>AS C29E</b>	Pg 29
- for cable Ø 24 - 30 mm	<b>AS C36E</b>	Pg 36
- for cable Ø 8 - 12,5 mm	<b>AS M20E</b>	M 20
- for cable Ø 13,5 - 18 mm	<b>AS M25E</b>	M 25
- for cable Ø 17 - 24 mm	<b>AS M32E</b>	M 32
- for cable Ø 24 - 30 mm	<b>AS M40E</b>	M 40

dimensions in mm

### AS C..E - AS M..E

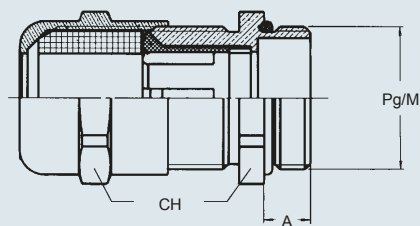

AS C..E	A	CH
<b>11</b>	6	20
<b>13,5</b>	6,5	22
<b>16</b>	6,5	24
<b>21</b>	7	30
<b>29</b>	8	40
<b>36</b>	9	50

AS M..E	A	CH
<b>20</b>	7	22
<b>25</b>	8	30
<b>32</b>	8,5	40
<b>40</b>	8,5	50

dimensions shown are not binding  
and may be changed without notice

# CR metal cable glands



- IP65 degree of protection (EN 60529) for use with connector enclosures
- Pg threading according to DIN 40430 and DIN 46320
- made of die-cast aluminum alloy
- anti-aging rubber gasket
- washers in zinc-plated steel

## metal cable clamps with collar, including gaskets and washers



## metal cable clamps without collar, gaskets and washers



description	part No.	Pg threading	part No.	Pg threading
- rubber hole Ø 12 mm	<b>CRS 13.5</b>	13,5		
- rubber hole Ø 14 mm	<b>CRS 16</b>	16		
- rubber hole Ø 18 mm	<b>CRS 21</b>	21		
- rubber hole Ø 25 mm	<b>CRS 29</b>	29		
- rubber hole Ø 32 mm	<b>CRS 36</b>	36		
- rubber hole Ø 38 mm	<b>CRS 42</b>	42		
without gasket and washer, not coated (order separately)			<b>CRS 16 C</b>	
- threading Pg 16			<b>CRS 21 C</b>	
- threading Pg 21				
kit comprising a full gasket and two washers (for cable anchoring CRS..C)			<b>CRA 16</b>	16
- rubber hole Ø 14 mm			<b>CRA 21</b>	21
- rubber hole Ø 18 mm				
kit comprising a multiple gasket and two washers (for cable anchoring CRS..C)			<b>CRAC 16</b>	16
- rubber hole Ø 7,5 - 10 - 12,5 - 15 mm			<b>CRAC 21</b>	21
- rubber hole Ø 10 - 13 - 16 - 19 mm				

dimensions in mm

### CRS

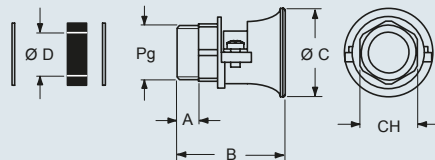

CRS	A	B	Ø C	Ø D	CH
13,5	7	36	28	12	22
16	8,5	41	32	14	24
21	10	47	39	18	30
29	10,5	58	55	25	41
36	13	67,5	67	32	50
42	13	72,5	75	38	55

dimensions in mm

### CRS..C

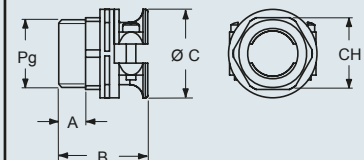

CRS..C	A	B	Ø C	CH
16	8	30	30	24
21	10	36	37	30

### CRA

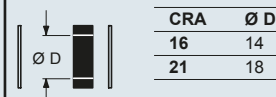

CRA	Ø D
16	14
21	18

### CRAC

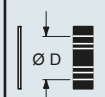

CRAC	Ø D
16	7,5 - 10 - 12,5 - 15
21	10 - 13 - 16 - 19

dimensions shown are not binding and may be changed without notice



# AS - AG metal cable glands



- IP65 degree of protection (EN 60529) for use with connector enclosures
- temperature range -25 °C / +100 °C
- metric threading according to EN 60423 and EN 62444
- Pg threading according to DIN 40430 and DIN 46320
- anti-aging rubber gasket
- galvanised steel washers

## semi-cable gland full gasket in nickel-plated brass



## semi-cable gland multiple gasket in nickel-plated brass



description	part No.	Pg threading	part No.	Pg or M threading
- for cable Ø 9	<b>AS C110</b>	11		
- for cable Ø 11	<b>AS C130</b>	13,5		
- for cable Ø 13	<b>AS C160</b>	16		
- for cable Ø 16	<b>AS C210</b>	21		
- for cable Ø 25	<b>AS C290</b>	29		
- for cable Ø 7,5 - 10			<b>AS C11T</b>	Pg 11
- for cable Ø 7,5 - 10 - 12,5			<b>AS C13T</b>	Pg 13,5
- for cable Ø 7,5 - 10 - 12,5 - 15			<b>AS C16T</b>	Pg 16
- for cable Ø 10 - 13 - 16 - 19			<b>AS C21T</b>	Pg 21
- for cable Ø 18 - 21 - 24 - 27			<b>AS C29T</b>	Pg 29
- for cable Ø 24 - 27 - 30 - 33			<b>AS C36T</b>	Pg 36
- for cable Ø 30 - 33 - 36 - 39			<b>AS C42T</b>	Pg 42
- for cable Ø 7 - 10 - 13			<b>AG M20T</b>	M 20
- for cable Ø 11 - 14 - 17			<b>AG M25T</b>	M 25
- for cable Ø 19 - 21 - 24			<b>AG M32T</b>	M 32
- for cable Ø 26 - 29 - 32			<b>AG M40T</b>	M 40
- for cable Ø 35 - 38 - 41			<b>AG M50T</b>	M 50

dimensions in mm

### AS C..O

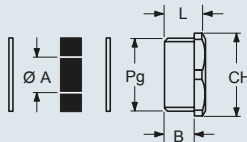

AS C..O	CH	Ø A	B	L
<b>11</b>	18	9	6	9
<b>13</b>	20	11	7,5	10,5
<b>16</b>	22	13	7,5	10,5
<b>21</b>	28	16	8	11,5
<b>29</b>	37	25	8	12

dimensions in mm

### AS C..T - AG M..T

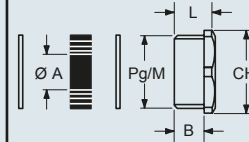

AS C..T	CH	Ø A	B	L
<b>11</b>	18	7,5 - 10	6	9
<b>13</b>	20	7,5 - 10 - 12,5	7,5	10,5
<b>16</b>	22	7,5 - 10 - 12,5 - 15	7,5	10,5
<b>21</b>	28	10 - 13 - 16 - 19	8	11,5
<b>29</b>	37	18 - 21 - 24 - 27	8	12
<b>36</b>	47	24 - 27 - 30 - 33	9,5	14
<b>42</b>	54	30 - 33 - 36 - 39	10	16

AG M..T	CH	Ø A	B	L
<b>20</b>	20	6 - 8 - 10	7,5	10,5
<b>25</b>	25	11 - 14 - 17	8	11,5
<b>32</b>	32	19 - 21 - 24	8	12
<b>40</b>	40	26 - 29 - 32	8	12
<b>50</b>	50	35 - 38 - 41	9,5	14

dimensions shown are not binding  
and may be changed without notice

- IP68 degree of protection (EN 60529)
- metric threading according to EN 60423 and EN 62444
- Pg threading according to DIN 40430 and DIN 46320
- anti-aging rubber O-ring gasket
- temperature range -25 °C / +120 °C

## sealing plug in nickel-plated brass



description	part No.	Pg or M threading
- for Pg 11 threading	<b>AS C11B</b>	Pg 11
- for Pg 13,5 threading	<b>AS C13B</b>	Pg 13,5
- for Pg 16 threading	<b>AS C16B</b>	Pg 16
- for Pg 21 threading	<b>AS C21B</b>	Pg 21
- for Pg 29 threading	<b>AS C29B</b>	Pg 29
- for Pg 36 threading	<b>AS C36B</b>	Pg 36
- for Pg 42 threading	<b>AS C42B</b>	Pg 42
- for M 20 threading	<b>AS M20B</b>	M 20
- for M 25 threading	<b>AS M25B</b>	M 25
- for M 32 threading	<b>AS M32B</b>	M 32
- for M 40 threading	<b>AS M40B</b>	M 40
- for M 50 threading	<b>AS M50B</b>	M 50

dimensions in mm

### AS C..B - AS M..B

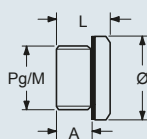

AS C..B	Ø	A	L
11	20	6	9
13,5	22	6,5	9,5
16	24	6,5	9,5
21	30	7	11
29	39	8	12
36	50	9	15
42	57	10	16

AS M..B	Ø	A	L
20	22	6,5	8,5
25	27	7	10
32	34	8	11
40	44	9	13
50	54	10	14,5

dimensions shown are not binding  
and may be changed without notice

# AS metal cable glands



- metric threading according to EN 60423 and EN 62444
- Pg threading according to DIN 40430 and DIN 46320
- anti-aging rubber O-ring gasket

## reduction nipples in nickel-plated brass including gasket



## lock nuts in nickel-plated brass

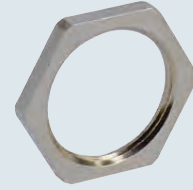

description	part No.	part No.	Pg or M threading
- male Pg 11 / female Pg 13,5 threading - male Pg 13,5 / female Pg 16 threading - male Pg 16 / female Pg 21 threading - male Pg 21 / female Pg 29 threading - male Pg 29 / female Pg 36 threading - male Pg 36 / female Pg 42 threading - male Pg 42 / female Pg 48 threading	<b>AS C11C</b> <b>AS C13C</b> <b>AS C16C</b> <b>AS C21C</b> <b>AS C29C</b> <b>AS C36C</b> <b>AS C42C</b>		
- male M 20 / female M 25 threading - male M 25 / female M 32 threading - male M 32 / female M 40 threading - male M 40 / female M 50 threading - male M 50 / female M 63 threading	<b>AS M20C</b> <b>AS M25C</b> <b>AS M32C</b> <b>AS M40C</b> <b>AS M50C</b>		
- for Pg 11 threading - for Pg 13,5 threading - for Pg 16 threading - for Pg 21 threading - for Pg 29 threading - for Pg 36 threading - for Pg 42 threading - for Pg 48 threading		<b>AS C11N</b> <b>AS C13N</b> <b>AS C16N</b> <b>AS C21N</b> <b>AS C29N</b> <b>AS C36N</b> <b>AS C42N</b> <b>AS C48N</b>	Pg 11 Pg 13,5 Pg 16 Pg 21 Pg 29 Pg 36 Pg 42 Pg 48
- for M 20 threading - for M 25 threading - for M 32 threading - for M 40 threading - for M 50 threading		<b>AS M20N</b> <b>AS M25N</b> <b>AS M32N</b> <b>AS M40N</b> <b>AS M50N</b>	M 20 M 25 M 32 M 40 M 50

dimensions in mm

### AS C..C

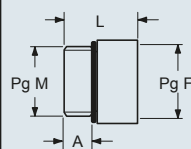

AS C..C	Pg M	Pg F	A	L
11	11	13,5	6	17,5
13,5	13,5	16	6,5	19
16	16	21	6,5	21
21	21	29	7	23
29	29	36	8	28
36	36	42	9	31
42	42	48	10	33

### AS M..C

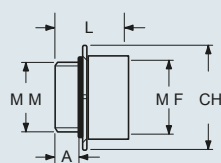

AS M..C	M M	M F	CH	A	L
20	20	25	28	7	20
25	25	32	36	8	21,5
32	32	40	42	8,5	22
40	40	50	52	8,5	23
50	50	63	65	9,5	25

dimensions in mm

### AS C..N - AS M..N

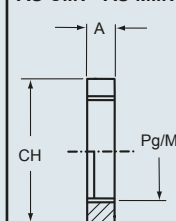

AS C..N	A	CH
11	2,9	21
13,5	3,1	23
16	3,1	26
21	3,6	32
29	4,1	41
36	5,1	51
42	5,1	60
48	5,6	64

AS M..N	A	CH
20	3,5	24
25	3,5	30
32	4,5	35
40	4,5	45
50	5,5	55

dimensions shown are not binding and may be changed without notice

# AS - AR - AF insulating cable glands



- AS...I IP68 degree of protection (EN 60529)<sup>(1)</sup> for use with lock nuts (page 12)
- ARP/AFP IP67 degree of protection (EN 60529)
- temperature range -25 °C / +100 °C
- metric threading according to EN 60423 and EN 62444
- Pg threading according to DIN 40430 and DIN 46320
- anti-aging rubber gaskets
- AS C/AS M grey RAL 7001, AS C11I / AS M 20I grey RAL 7035, AS C11IN / AS M20IN black RAL 9005

## complete insulating cable gland<sup>(2)</sup>

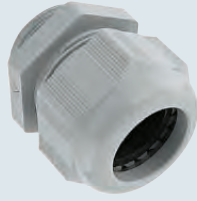

## complete insulating cable gland



description	part No.	Pg or M threading	part No.	Pg threading
- for cable Ø 3,5 - 10 mm	<b>AS C11I</b>	grey	Pg 11	
- for cable Ø 3,5 - 10 mm	<b>AS C11IN</b>	black	Pg 11	
- for cable Ø 5 - 12 mm	<b>AS C13I</b>		Pg 13,5	
- for cable Ø 7 - 14 mm	<b>AS C16I</b>		Pg 16	
- for cable Ø 9 - 18 mm	<b>AS C21I</b>		Pg 21	
- for cable Ø 14 - 25 mm	<b>AS C29I</b>		Pg 29	
- for cable Ø 18 - 32 mm	<b>AS C36I</b>		Pg 36	
- for cable Ø 24 - 38,5 mm	<b>AS C42I</b>		Pg 42	
- for cable Ø 5 - 12,5 mm	<b>AS M20I</b>	grey	M 20	
- for cable Ø 5 - 12,5 mm	<b>AS M20IN</b>	black	M 20	
- for cable Ø 9 - 18 mm	<b>AS M25I</b>		M 25	
- for cable Ø 14 - 25 mm	<b>AS M32I</b>		M 32	
- for cable Ø 18 - 32 mm *	<b>AS M40I</b>		M 40	
- for cable Ø 24 - 38,5 mm *	<b>AS M50I</b>		M 50	
- rubber hole Ø 7,5 - 10 - 12,5 mm			<b>ARP 11</b>	11
- rubber hole Ø 7,5 - 10 - 12,5 mm			<b>ARP 13</b>	13,5
- rubber hole Ø 7,5 - 10 - 12,5 - 15 mm			<b>AFP 16</b>	16
- rubber hole Ø 10 - 13 - 16 - 19 mm			<b>AFP 21</b>	21
- rubber hole Ø 18 - 21 - 24 - 27 mm			<b>AFP 29</b>	29
- rubber hole Ø 24 - 27 - 30 - 33 mm			<b>AFP 36</b>	36
- rubber hole Ø 30 - 33 - 36 - 39 mm			<b>ARP 42</b>	42
- rubber hole Ø 36 - 39 - 42 - 45 mm			<b>ARP 48</b>	48

(1) AS...I IP65 degree of protection for use with connector enclosures; IP68 if mounted with gasket (page 27).

(2) UL, VDE, CSA approval

dimensions in mm

AS C..I - AS M..I

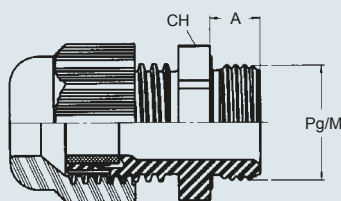

AS C..I	A	CH
11	8	22
13	9	24
16	10	27
21	11	33
29	11	42
36	13	53
42	13	60

AS M..I	A	CH
20	10	24
25	10	33
32	10	42
40	10	53
50	12	60

dimensions in mm

ARP / AFP

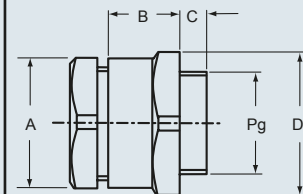

part No	A	B	C	D	Pg
<b>ARP 11</b>	19	20	9	24	11
<b>ARP 13</b>	22	19,5	9	26	13,5
<b>AFP 16</b>	24	21	10	29	16
<b>AFP 21</b>	30	26	10	39	21
<b>AFP 29</b>	41	29,5	10	50	29
<b>AFP 36</b>	50	33,5	10	58	36
<b>ARP 42</b>	54	28	12,5	60	42
<b>ARP 48</b>	64	41,5	13,5	77	48

dimensions shown are not binding and may be changed without notice

- IP65 degree of protection (EN 60529) for use with connector enclosures
- metric threading according to EN 60423 and EN 62444
- Pg threading according to DIN 40430 and DIN 46320
- anti-aging rubber gasket
- washers in zinc-plated steel

## semi-cable gland with multiple gasket in insulating material



description	part No.	Pg or M threading
- for cable Ø 7,5 - 10 - 12,5	<b>CRR 11</b> white	Pg 11
- for cable Ø 7,5 - 10 - 12,5	<b>CRR 11 N</b> black	Pg 11
- for cable Ø 7,5 - 10 - 12,5	<b>CRR 13</b>	Pg 13,5
- for cable Ø 7,5 - 10 - 12,5 - 15	<b>CRR 16</b>	Pg 16
- for cable Ø 10 - 13 - 16 - 19	<b>CRR 21</b>	Pg 21
- for cable Ø 18 - 21 - 24 - 27	<b>CRR 29</b>	Pg 29
- for cable Ø 24 - 27 - 30 - 33	<b>CRR 36</b>	Pg 36
- for cable Ø 30 - 33 - 36 - 39	<b>CRR 42</b>	Pg 42
- for cable Ø 7 - 10 - 13	<b>AG M20R</b> white	M 20
- for cable Ø 7 - 10 - 13	<b>AG M20RN</b> black	M 20
- for cable Ø 11 - 14 - 17	<b>AG M25R</b>	M 25
- for cable Ø 19 - 21 - 24	<b>AG M32R</b>	M 32

dimensions in mm

### CRR - AG M..R

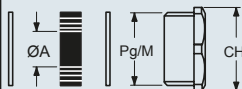

CRR	CH	Ø A
<b>11</b>	19	7,5 - 10 - 12,5
<b>11 N</b>	19	7,5 - 10 - 12,5
<b>13</b>	22	7,5 - 10 - 12,5
<b>16</b>	24	7,5 - 10 - 12,5 - 15
<b>21</b>	30	10 - 13 - 16 - 19
<b>29</b>	41	18 - 21 - 24 - 27
<b>36</b>	50	24 - 27 - 30 - 33
<b>42</b>	60	30 - 33 - 36 - 39

AG M..R	CH	Ø A
<b>20</b>	21	7 - 10 - 13
<b>20 N</b>	21	7 - 10 - 13
<b>25</b>	26	11 - 14 - 17
<b>32</b>	34	19 - 21 - 24

dimensions shown are not binding and may be changed without notice

# AR - AS insulating cable glands



- in thermoplastic material
- anti-aging rubber gasket
- metric threading according to EN 60423 and EN 62444
- Pg threading according to DIN 40430 and DIN 46320

## insulating sealing plugs



## lock nuts



description	part No.	Pg or M threading	part No.	Pg or M threading
- for Pg 11 threading	<b>ARD 11</b>	Pg 11		
- for Pg 13,5 threading	<b>ARD 13</b>	Pg 13,5		
- for Pg 16 threading	<b>ARD 16</b>	Pg 16		
- for Pg 21 threading	<b>ARD 21</b>	Pg 21		
- for Pg 29 threading	<b>ARD 29</b>	Pg 29		
- for Pg 36 threading	<b>ARD 36</b>	Pg 36		
- for Pg 48 threading	<b>ARD 48</b>	Pg 48		
- for M 20 threading	<b>AS M20D</b>	M 20		
- for M 25 threading	<b>AS M25D</b>	M 25		
- for M 32 threading	<b>AS M32D</b>	M 32		
- for M 40 threading	<b>AS M40D</b>	M 40		
- for M 50 threading	<b>AS M50D</b>	M 50		
- for Pg 11 threading			<b>ARC 11</b>	Pg 11
- for Pg 13,5 threading			<b>ARC 13</b>	Pg 13,5
- for Pg 16 threading			<b>ARC 16</b>	Pg 16
- for Pg 21 threading			<b>ARC 21</b>	Pg 21
- for Pg 29 threading			<b>ARC 29</b>	Pg 29
- for Pg 36 threading			<b>ARC 36</b>	Pg 36
- for Pg 48 threading			<b>ARC 48</b>	Pg 48
- for M 20 threading			<b>AS M20L</b>	M 20
- for M 25 threading			<b>AS M25L</b>	M 25
- for M 32 threading			<b>AS M32L</b>	M 32
- for M 40 threading			<b>AS M40L</b>	M 40
- for M 50 threading			<b>AS M50L</b>	M 50

dimensions in mm

### ARD - AS M..D

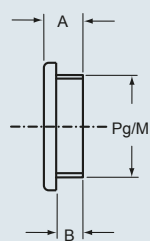

part No.	A	B
<b>ARD 11</b>	7,5	6
<b>ARD 13</b>	7,5	6
<b>ARD 16</b>	7,5	6
<b>ARD 21</b>	10	8
<b>ARD 29</b>	10	8
<b>ARD 36</b>	12	10
<b>ARD 48</b>	14	12

part No.	A	B
<b>AS M20D</b>	10,5	8
<b>AS M25D</b>	11	8
<b>AS M32D</b>	13,5	10
<b>AS M40D</b>	14	10
<b>AS M50D</b>	17	12

dimensions in mm

### ARC

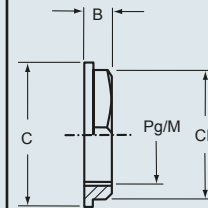

part No.	CH	B	C
<b>ARC 11</b>	24	5	26
<b>ARC 13</b>	27	6	29
<b>ARC 16</b>	30	6	33
<b>ARC 21</b>	36	7	39
<b>ARC 29</b>	46	7	50
<b>ARC 36</b>	60	8	66
<b>ARC 48</b>	70	8	78

### AS M..L

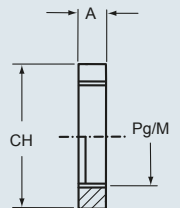

part No.	CH	A
<b>AS M20L</b>	24	5
<b>AS M25L</b>	30	6
<b>AS M32L</b>	38	7,5
<b>AS M40L</b>	50	8
<b>AS M50L</b>	60	9

dimensions shown are not binding and may be changed without notice

- IP66/IP68 degree of protection (5 bar; 30 min - EN 60529)
- temperature range -40 °C / +75 °C
- metric threading according to EN 60423 and EN 62444
- EPDM gasket

**complete cable gland in nickel-plated brass, long thread \***



description	part No.	M threading
- for cable Ø 4,0 - 7,0 mm	<b>AW M12PHX</b>	M 12
- for cable Ø 5,0 - 10,0 mm	<b>AW M16PHX</b>	M 16
- for cable Ø 6,0 - 13,0 mm	<b>AW M20PHX</b>	M 20
- for cable Ø 10,0 - 17,0 mm	<b>AW M25PHX</b>	M 25
- for cable Ø 13,0 - 21,0 mm	<b>AW M32PHX</b>	M 32
- for cable Ø 16,0 - 28,0 mm	<b>AW M40PHX</b>	M 40
- for cable Ø 21,0 - 35,0 mm	<b>AW M50PHX</b>	M 50
- for cable Ø 34,0 - 48,0 mm	<b>AW M63PHX</b>	M 63

II 2 G Ex e IIC Gb

II 2 D Ex tb IIIC Db IP68

\* to be used with metal lock nuts (page 14)

dimensions in mm

**AW M..PHX**

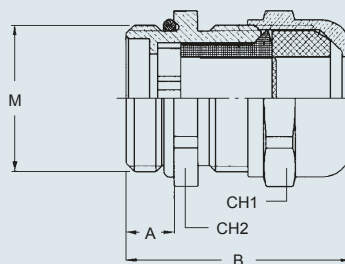

AW M..PHX	A	B min	B max	CH1	CH2
<b>12</b>	12,0	30,0	37,0	16,0	16,0
<b>16</b>	12,0	33,0	41,0	20,0	20,0
<b>20</b>	12,0	35,0	43,0	24,0	24,0
<b>25</b>	12,0	38,0	47,0	29,0	29,0
<b>32</b>	15,0	43,0	51,0	36,0	36,0
<b>40</b>	15,0	51,0	62,0	46,0	46,0
<b>50</b>	15,0	57,0	68,0	55,0	55,0
<b>63</b>	15,0	61,0	72,0	68,0	68,0

dimensions shown are not binding and may be changed without notice

# AW..NX lock nuts



- metric threading according to EN 60423 and EN 62444

**lock nuts  
in nickel-plated brass**

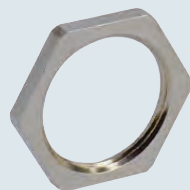

description	part No.	M threading
- for M 12 threading	<b>AW M12NX</b>	M 12
- for M 16 threading	<b>AW M16NX</b>	M 16
- for M 20 threading	<b>AW M20NX</b>	M 20
- for M 25 threading	<b>AW M25NX</b>	M 25
- for M 32 threading	<b>AW M32NX</b>	M 32
- for M 40 threading	<b>AW M40NX</b>	M 40
- for M 50 threading	<b>AW M50NX</b>	M 50
- for M 63 threading	<b>AW M63NX</b>	M 63

dimensions shown are not binding  
and may be changed without notice



- IP66/IP68 degree of protection (5 bar; 30 min - EN 60529)
- temperature range -40 °C / +75 °C
- metric threading according to EN 60423 and EN 62444
- in thermoplastic material

**complete insulating cable gland \***



description

part No.

M  
threading

- for cable Ø 3,0 - 6,0 mm
- for cable Ø 4,5 - 9,0 mm
- for cable Ø 7,0 - 13,0 mm
- for cable Ø 10,0 - 17,0 mm
- for cable Ø 13,0 - 21,0 mm
- for cable Ø 17,0 - 28,0 mm
- for cable Ø 23,0 - 35,0 mm
- for cable Ø 34,0 - 48,0 mm

**AW M12INX**  
**AW M16INX**  
**AW M20INX**  
**AW M25INX**  
**AW M32INX**  
**AW M40INX**  
**AW M50INX**  
**AW M63INX**

M 12  
M 16  
M 20  
M 25  
M 32  
M 40  
M 50  
M 63

II 2 G Ex e IIC Gb

I 2 D Ex tb IIIC Db IP68

\* to be used with metal lock nuts (page 14)

dimensions in mm

**AW M..INX**

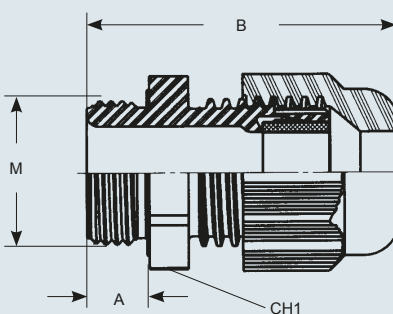

AW M..INX	A	B min	B max	CH
<b>12</b>	9,0	29,0	34,0	16,0
<b>16</b>	9,0	31,0	37,0	20,0
<b>20</b>	10,0	36,0	45,0	24,0
<b>25</b>	10,0	38,0	47,0	29,0
<b>32</b>	12,0	42,0	51,0	36,0
<b>40</b>	12,0	52,0	65,0	46,0
<b>50</b>	14,0	59,0	72,0	55,0
<b>63</b>	15,0	64,0	78,0	68,0

dimensions shown are not binding  
and may be changed without notice

**Rapid assembly and disassembly, without the use of tools**

IP66 degree of protection  
(according to EN 60529)

Fully insert the cable-guide  
into the fitting

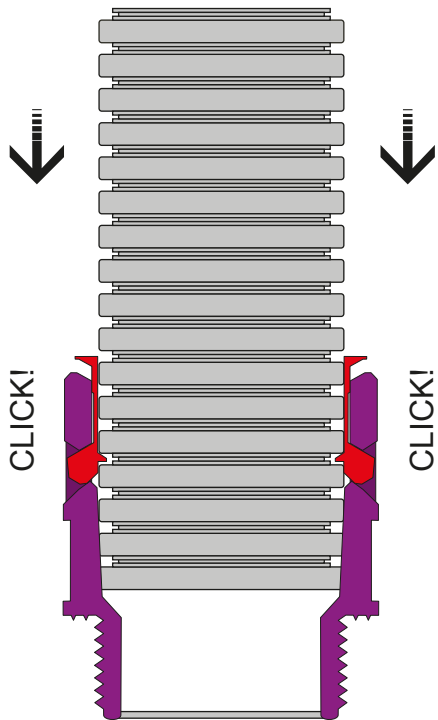

IP68 degree of protection  
(according to EN 60529)

- Apply the O-ring gasket (AIR G) in the cable-guide's final section
- Fully insert the cable-guide into the fitting
- Place the gasket (AIR B) between the fitting and the support base

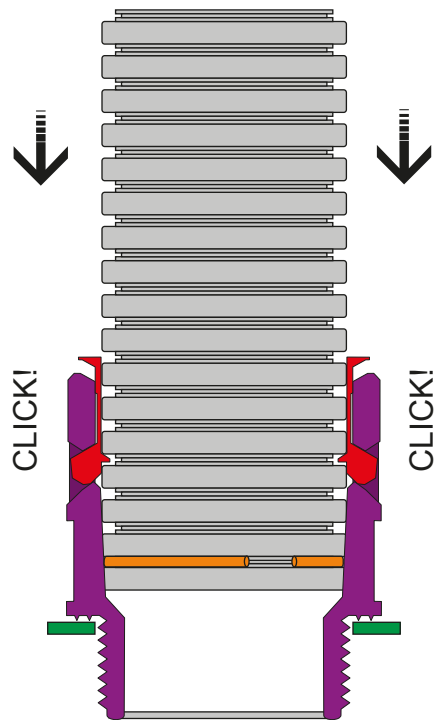

Disassembly

Keep the sealing ring of the fitting  
pressed down and rotate to extract the  
cable-guide

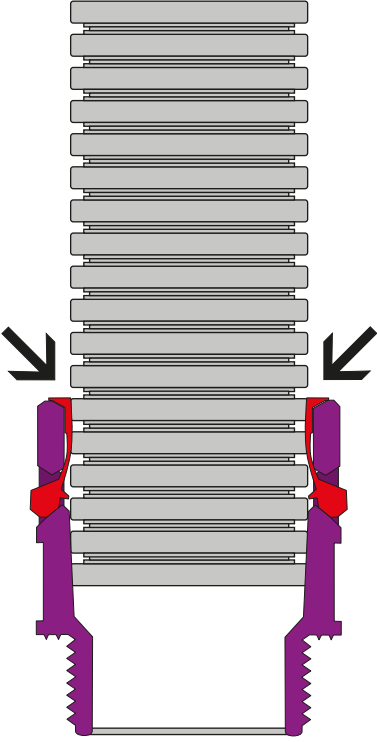

- ❶ Flexible, mechanically solid cable-guide with a special section patented for rapid assembly without the use of tools.
- ❷ Indication, on the fitting, of the nominal diameter of the cable-guide that may be inserted. Assembly without the use of accessories and tools.
- ❸ 12-sided edge to screw the fitting using a polygonal key.
- ❹ 6-sided edge to tighten the fitting using a forked key.
- ❺ Identification of the fitting's threading size.
- ❻ Pressure unblocking device. The cable-guide may be extracted from the fitting without the use of accessories and tools.
- ❼ Pull-resistant ring, which works along the entire perimeter of the cable-guide enabling effective discharge resistance.
- ❽ Fitting with conical internal walls to ensure an IP66 degree of protection (according to EN 60529).
- ❾ Fitting base formed by circular rings to ensure an IP66 degree of protection (according to EN 60529).
- ❿ IP68 degree of protection, obtainable by adding an O-ring gasket (AIR G) in the last cable-guide section and a gasket (AIR B) on the support base.

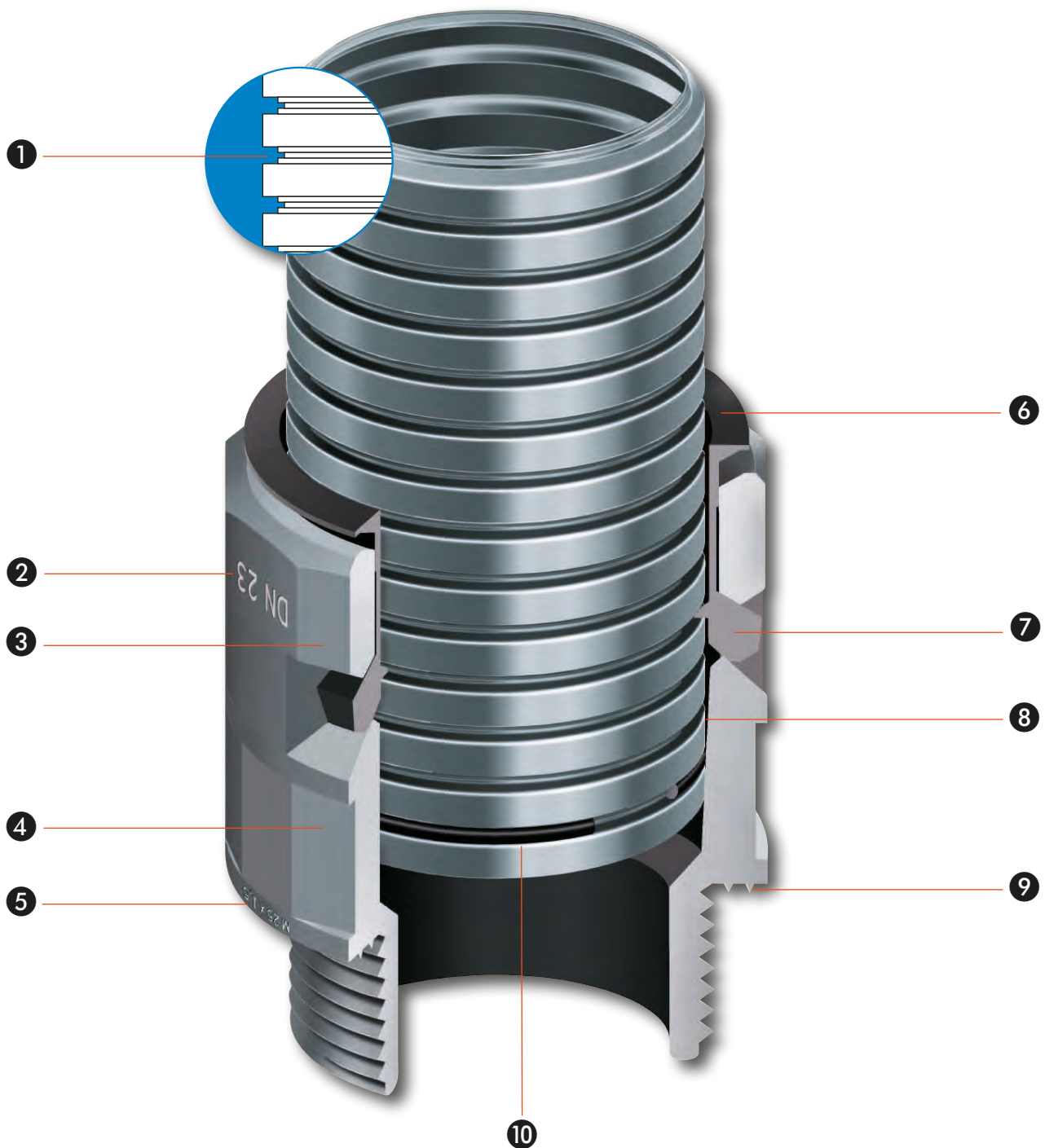



Composition of the part No.: e.g. **AI C 13 V 12 N**

article series \_\_\_\_\_  
 metric or Pg threading \_\_\_\_\_  
 threading size \_\_\_\_\_  
 fitting version \_\_\_\_\_  
 flexible tube nominal diameter \_\_\_\_\_  
 black version component \_\_\_\_\_

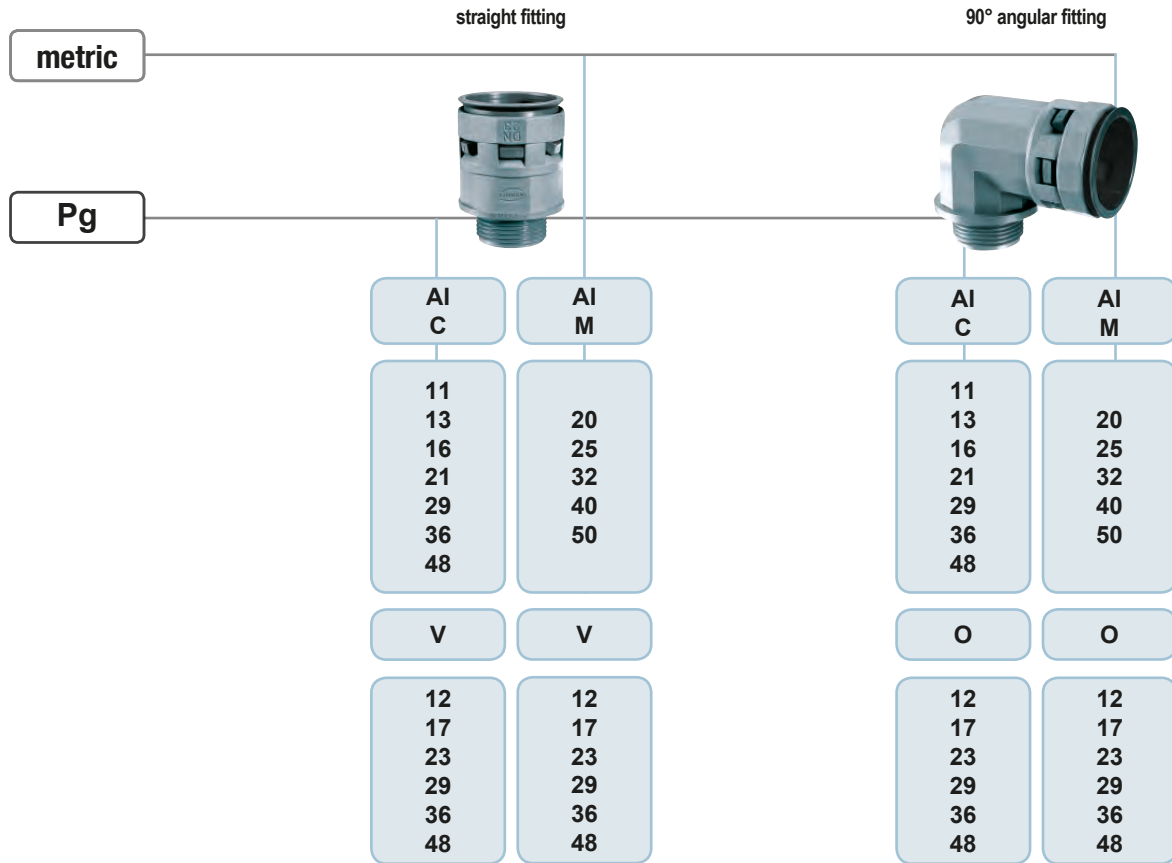

cable-guide support grey

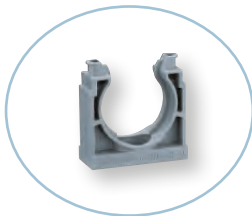

cable-guide support black

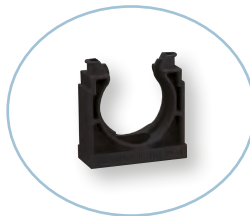

steel cable-guide support



gaskets for fitting base

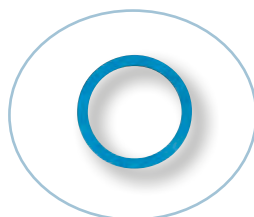

O-ring gaskets for flexible tubes

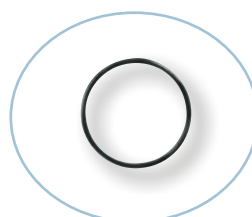

**Technical characteristics of the tubes**



flexible tube series	resistance to compression	shock resistance	resistance to traction	temperature limit			self-extinguishing UL 94 classification	resistance to glow-wire in line with IEC 60695 -2-1	certifications
				lower	upper	short term			
abbrev.									
<b>AIT A..</b>	>250 N	6 J	> 300 N	-40 °C	+105 °C	+150 °C	V2	850 °C	UL
<b>AIT E..</b>	>200 N	2 J	> 300 N	-40 °C	+105 °C	+140 °C	HB	750 °C	

**Nominal diameter of the flexible tubes that may be inserted into the fittings (mm)**

**Pg threading**

fitting series	11	13,5	16	21	29	36	48
<b>AI C.. V..</b>	Ø 12	Ø 12-17	Ø 17	Ø 23	Ø 29	Ø 36	Ø 48
<b>AI C.. O..</b>	Ø 12	Ø 17	Ø 17	Ø 23	Ø 29	Ø 36	Ø 48

**Metric threading**

fitting series	20	25	32	40	50
<b>AI M.. V..</b>	Ø 12-17	Ø 17-23	Ø 23-29	Ø 29-36	Ø 36-48
<b>AI M.. O..</b>	Ø 12-17	Ø 23	Ø 29	Ø 36	Ø 48



- fitting made of self-extinguishing PA6 polyamide without halogen, phosphorus and cadmium
- IP65 static and IP54 dynamic degree of protection (according to EN 60529)
- for IP68 (static use) or IP67 (dynamic use) degree of protection according to EN 60529, O-ring gaskets and gaskets for fitting base (page 26) shall be required
- temperature range -30 °C / +100 °C
- metric threading according to EN 60423
- Pg threading according to DIN 40430
- insertion and extraction of flexible tubes without the use of tools
- hexagonal base for tightening ease

## straight fitting grey



## straight fitting black



description	part No.	Pg or M threading	part No.	Pg or M threading
- for flexible tubes, nominal Ø 12 *	<b>AI C11V12</b>	Pg 11	<b>AI C11V12N</b>	Pg 11
- for flexible tubes, nominal Ø 12 *	<b>AI C13V12</b>	Pg 13,5	<b>AI C13V12N</b>	Pg 13,5
- for flexible tubes, nominal Ø 17 *	<b>AI C13V17</b>	Pg 13,5	<b>AI C13V17N</b>	Pg 13,5
- for flexible tubes, nominal Ø 17 *	<b>AI C16V17</b>	Pg 16	<b>AI C16V17N</b>	Pg 16
- for flexible tubes, nominal Ø 23 *	<b>AI C21V23</b>	Pg 21	<b>AI C21V23N</b>	Pg 21
- for flexible tubes, nominal Ø 29 *	<b>AI C29V29</b>	Pg 29	<b>AI C29V29N</b>	Pg 29
- for flexible tubes, nominal Ø 36 *	<b>AI C36V36</b>	Pg 36	<b>AI C36V36N</b>	Pg 36
- for flexible tubes, nominal Ø 48 *	<b>AI C48V48</b>	Pg 48	<b>AI C48V48N</b>	Pg 48
- for flexible tubes, nominal Ø 12 *	<b>AI M20V12</b>	M 20	<b>AI M20V12N</b>	M 20
- for flexible tubes, nominal Ø 17 *	<b>AI M20V17</b>	M 20	<b>AI M20V17N</b>	M 20
- for flexible tubes, nominal Ø 17 *	<b>AI M25V17</b>	M 25	<b>AI M25V17N</b>	M 25
- for flexible tubes, nominal Ø 23 * <sup>1)</sup>	<b>AI M25V23</b>	M 25	<b>AI M25V23N</b>	M 25
- for flexible tubes, nominal Ø 23 * <sup>1)</sup>	<b>AI M32V23</b>	M 32	<b>AI M32V23N</b>	M 32
- for flexible tubes, nominal Ø 29 * <sup>1)</sup>	<b>AI M32V29</b>	M 32	<b>AI M32V29N</b>	M 32
- for flexible tubes, nominal Ø 29 * <sup>1)</sup>	<b>AI M40V29</b>	M 40	<b>AI M40V29N</b>	M 40
- for flexible tubes, nominal Ø 36 * <sup>1)</sup>	<b>AI M40V36</b>	M 40	<b>AI M40V36N</b>	M 40
- for flexible tubes, nominal Ø 36 * <sup>1)</sup>	<b>AI M50V36</b>	M 50	<b>AI M50V36N</b>	M 50
- for flexible tubes, nominal Ø 48 * <sup>1)</sup>	<b>AI M50V48</b>	M 50	<b>AI M50V48N</b>	M 50

\* UL mark with approval from the Underwriters Laboratories

- 1) for use with:
- lock nuts (page 12)
  - multipole connector enclosures CF/MF 6/10/16/24/32/48/50 (new version)
  - IP68 high protection multipole connector enclosures
  - BIG multipole connector enclosures

dimensions in mm

### AI C..V / AI C..V..N - AI M..V / AI M..V..N

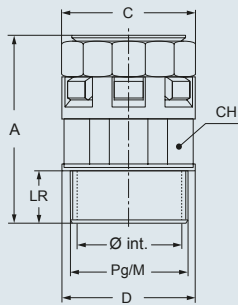

part No.	part No.	Pg	Ø int.	A	C	D	CH	LR
grey		black						
<b>AI C11V12</b>	<b>AI C11V12N</b>	11	14	37,5	26	25,5	20	11
<b>AI C13V12</b>	<b>AI C13V12N</b>	13,5	14	37,5	26	25,5	20	11
<b>AI C13V17</b>	<b>AI C13V17N</b>	13,5	14	44,5	31	28	27	11,5
<b>AI C16V17</b>	<b>AI C16V17N</b>	16	17	44,5	31	29	27	11,5
<b>AI C21V23</b>	<b>AI C21V23N</b>	21	22	48,5	37	36,5	34	12,5
<b>AI C29V29</b>	<b>AI C29V29N</b>	29	30	49,5	46	46	42	12,5
<b>AI C36V36</b>	<b>AI C36V36N</b>	36	37,5	55	54	56	50	14
<b>AI C48V48</b>	<b>AI C48V48N</b>	48	50	56	69	69,5	66	14

part No.	part No.	M	Ø int.	A	C	D	CH	LR
grey		black						
<b>AI M20V12</b>	<b>AI M20V12N</b>	20x1,5	14	37	26	25,5	20	11
<b>AI M20V17</b>	<b>AI M20V17N</b>	20x1,5	14,5	44	31	30	27	11
<b>AI M25V17</b>	<b>AI M25V17N</b>	25x1,5	18,5	45	31	34	27	12
<b>AI M25V23</b>	<b>AI M25V23N</b>	25x1,5	18,5	48	37	37	34	12
<b>AI M32V23</b>	<b>AI M32V23N</b>	32x1,5	25,5	51	37	42	34	15
<b>AI M32V29</b>	<b>AI M32V29N</b>	32x1,5	25,5	52	46	46	42	15
<b>AI M40V29</b>	<b>AI M40V29N</b>	40x1,5	32	56	46	52	42	16
<b>AI M40V36</b>	<b>AI M40V36N</b>	40x1,5	32	60	54	54	50	19
<b>AI M50V36</b>	<b>AI M50V36N</b>	50x1,5	42	60	54	62	50	19
<b>AI M50V48</b>	<b>AI M50V48N</b>	50x1,5	42	61	69	69	66	19

dimensions shown are not binding and may be changed without notice

- fitting made of self-extinguishing PA6 polyamide without halogen, phosphorus and cadmium
- IP65 static and IP54 dynamic degree of protection (according to EN 60529)
- for IP68 (static use) or IP67 (dynamic use) degree of protection according to EN 60529, O-ring gaskets and gaskets for fitting base (page 26) shall be required
- temperature range -30 °C / +100 °C
- metric threading according to EN 60423
- Pg threading according to DIN 40430
- insertion and extraction of flexible tubes without the use of tools
- hexagonal base for tightening ease

## 90° angular fitting grey



## 90° angular fitting black



description	part No.	Pg or M threading	part No.	Pg or M threading
- for flexible tubes, nominal Ø 12	<b>AI C11O12</b>	Pg 11	<b>AI C11O12N</b>	Pg 11
- for flexible tubes, nominal Ø 17	<b>AI C13O17</b>	Pg 13,5	<b>AI C13O17N</b>	Pg 13,5
- for flexible tubes, nominal Ø 17	<b>AI C16O17</b>	Pg 16	<b>AI C16O17N</b>	Pg 16
- for flexible tubes, nominal Ø 23	<b>AI C21O23</b>	Pg 21	<b>AI C21O23N</b>	Pg 21
- for flexible tubes, nominal Ø 29	<b>AI C29O29</b>	Pg 29	<b>AI C29O29N</b>	Pg 29
- for flexible tubes, nominal Ø 36	<b>AI C36O36</b>	Pg 36	<b>AI C36O36N</b>	Pg 36
- for flexible tubes, nominal Ø 48	<b>AI C48O48</b>	Pg 48	<b>AI C48O48N</b>	Pg 48
- for flexible tubes, nominal Ø 12	<b>AI M20O12</b>	M 20	<b>AI M20O12N</b>	M 20
- for flexible tubes, nominal Ø 17	<b>AI M20O17</b>	M 20	<b>AI M20O17N</b>	M 20
- for flexible tubes, nominal Ø 23	<b>AI M25O23</b>	M 25	<b>AI M25O23N</b>	M 25
- for flexible tubes, nominal Ø 29 <sup>1)</sup>	<b>AI M32O29</b>	M 32	<b>AI M32O29N</b>	M 32
- for flexible tubes, nominal Ø 36 <sup>1)</sup>	<b>AI M40O36</b>	M 40	<b>AI M40O36N</b>	M 40
- for flexible tubes, nominal Ø 48 <sup>1)</sup>	<b>AI M50O48</b>	M 50	<b>AI M50O48N</b>	M 50

1) for use with:

- lock nuts (page 12)
- multipole connector enclosures CF/MF 32/48/50
- IP68 high protection multipole connector enclosures
- BIG multipole connector enclosures

dimensions in mm

**AI C..O / AI C..O..N - AI M..O / AI M..O..N**

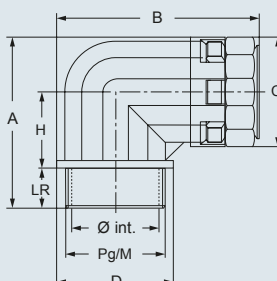

part No.	part No.	Pg	Ø int.	A	B	C	D	CH	LR
grey	black								
<b>AI C11O12</b>	<b>AI C11O12N</b>	11	14	39	45	25	25	15	11
<b>AI C13O12</b>	<b>AI C13O12N</b>	13,5	14	45	56,5	30	27	18	11,5
<b>AI C16O17</b>	<b>AI C16O17N</b>	16	17	45	57,5	30	29	18	11,5
<b>AI C21O23</b>	<b>AI C21O23N</b>	21	22	53	65,5	37	36,5	23	12,5
<b>AI C29O29</b>	<b>AI C29O29N</b>	29	30	65	76	45	46	28	12,5
<b>AI C36O36</b>	<b>AI C36O36N</b>	36	37,5	79	89,5	54	56	33	14
<b>AI C48O48</b>	<b>AI C48O48N</b>	48	50	92	103,5	68	69,5	39	14

part No.	part No.	M	Ø int.	A	B	C	D	CH	LR
grey	black								
<b>AI M20O12</b>	<b>AI M20O12N</b>	20x1,5	12,3	39	45,5	25	26	15	11
<b>AI M20O17</b>	<b>AI M20O17N</b>	20x1,5	14,5	45	58	30	30	18	11
<b>AI M25O23</b>	<b>AI M25O23N</b>	25x1,5	18,5	53	66	36,5	37	23	12
<b>AI M32O29</b>	<b>AI M32O29N</b>	32x1,5	25,5	66	76	45	46	27	15
<b>AI M40O36</b>	<b>AI M40O36N</b>	40x1,5	32	79	89	54	55	33	19
<b>AI M50O48</b>	<b>AI M50O48N</b>	50x1,5	42	92	103	68	69	39	19

dimensions shown are not binding and may be changed without notice

- fitting made of modified PA6 polyamide without halogen, phosphorus and cadmium
- resistant to UV rays (it is preferable to use the black version in the presence of UV rays)
- self-extinguishing V2 according to UL94
- resistance to 850 °C glow-wire according to IEC 60695-2-1
- temperature range -40 °C / +105 °C (short term: 150 °C)
- does not propagate flames, according to EN 50086-1
- insertion and extraction in the fitting without the use of tools
- ensuring the insulation and mechanical protection of cables

## standard flexible tube grey

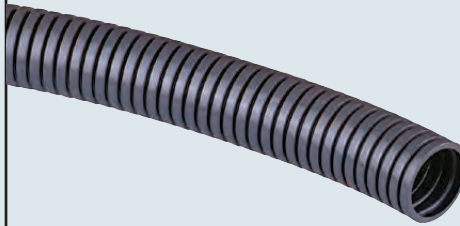

## standard flexible tube black



description	part No.	part No.
- nominal Ø 12 *	<b>AIT A12</b>	<b>AIT A12N</b>
- nominal Ø 17 *	<b>AIT A17</b>	<b>AIT A17N</b>
- nominal Ø 23 *	<b>AIT A23</b>	<b>AIT A23N</b>
- nominal Ø 29 *	<b>AIT A29</b>	<b>AIT A29N</b>
- nominal Ø 36 *	<b>AIT A36</b>	<b>AIT A36N</b>
- nominal Ø 48 *	<b>AIT A48</b>	<b>AIT A48N</b>

\* UL mark with approval from the Underwriters Laboratories

dimensions in mm

AIT A - AIT A..N

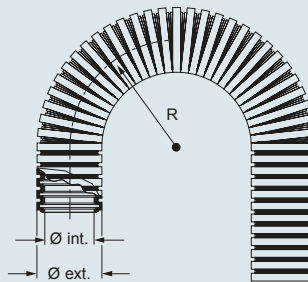

part No. grey	part No. black	Ø int.	Ø ext.	R minimum curving radius (static)	standard package (m)
<b>AIT A12</b>	<b>AIT A12N</b>	12,2	15,8	30	50
<b>AIT A17</b>	<b>AIT A17N</b>	16,8	21,2	40	50
<b>AIT A23</b>	<b>AIT A23N</b>	22,6	28,5	55	50
<b>AIT A29</b>	<b>AIT A29N</b>	28,3	34,5	65	50
<b>AIT A36</b>	<b>AIT A36N</b>	36,3	42,5	80	30
<b>AIT A48</b>	<b>AIT A48N</b>	47,4	54,5	95	30

dimensions shown are not binding and may be changed without notice



- fitting made of modified PA6 polyamide without halogen, phosphorus and cadmium
- self-extinguishing HB according to UL94
- resistance to 750 °C glow-wire according to IEC 60659-2-1
- temperature range -40 °C / +105 °C (short term: 140 °C)
- does not propagate flames according to IEC 50086
- insertion and extraction in the fitting without the use of tools
- ensuring the insulation and mechanical protection of cables

## light flexible tube grey

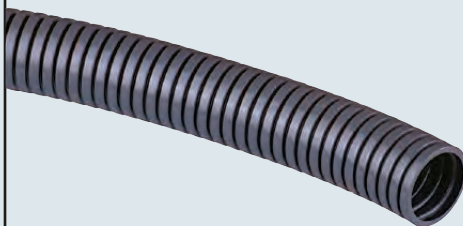

## light flexible tube black



description

- nominal Ø 12
- nominal Ø 17
- nominal Ø 23
- nominal Ø 29
- nominal Ø 36
- nominal Ø 48

part No.

AIT E12  
AIT E17  
AIT E23  
AIT E29  
AIT E36  
AIT E48

part No.

AIT E12N  
AIT E17N  
AIT E23N  
AIT E29N  
AIT E36N  
AIT E48N

dimensions in mm

AIT E - AIT E..N

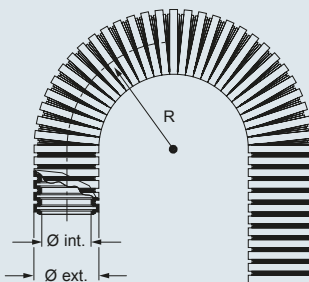

part No. grey	part No. black	Ø int.	Ø ext.	R minimum curving radius (static)	standard package (m)
AIT E12	AIT E12N	12,2	15,8	30	50
AIT E17	AIT E17N	16,8	21,2	40	50
AIT E23	AIT E23N	22,6	28,5	55	50
AIT E29	AIT E29N	28,4	34,5	65	50
AIT E36	AIT E36N	36,4	42,5	80	30
AIT E48	AIT E48N	47,5	54,5	95	30

dimensions shown are not binding  
and may be changed without notice

- made of modified PA6 polyamide
- without halogen, phosphorus and cadmium
- self-extinguishing
- temperature range -30 °C / +100 °C
- shock resistant
- for fixing cable-guides to the wall

## cable-guide support grey



## cable-guide support black

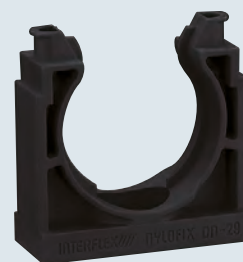

description

- nominal Ø 12
- nominal Ø 17
- nominal Ø 23
- nominal Ø 29
- nominal Ø 36
- nominal Ø 48

part No.

**AIR D12**  
**AIR D17**  
**AIR D23**  
**AIR D29**  
**AIR D36**  
**AIR D48**

part No.

**AIR D12N**  
**AIR D17N**  
**AIR D23N**  
**AIR D29N**  
**AIR D36N**  
**AIR D48N**

dimensions in mm

**AIR D - AIR D..N**

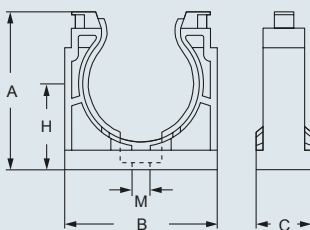

part No.	part No.	A	B	C	H	M
grey	black					
<b>AIR D12</b>	<b>AIR D12N</b>	26,5	25	20	15,5	M 5
<b>AIR D17</b>	<b>AIR D17N</b>	32,5	32	20	18,5	M 5
<b>AIR D23</b>	<b>AIR D23N</b>	41	40	20	23	M 6
<b>AIR D29</b>	<b>AIR D29N</b>	47	46	20	26	M 6
<b>AIR D36</b>	<b>AIR D36N</b>	57,5	56	20	32	M 6
<b>AIR D48</b>	<b>AIR D48N</b>	70,5	70	20	39	M 6

dimensions shown are not binding  
and may be changed without notice

**AIR Z:**

- made of galvanised steel
- with elastomer protection
- resistant to traction, shock and corrosion
- for fixing cable-guides to the wall

**steel cable-guide support**



**description**

**part No.**

- steel supports
- nominal Ø 12
  - nominal Ø 17
  - nominal Ø 23
  - nominal Ø 29
  - nominal Ø 36
  - nominal Ø 48

- AIR Z12**  
**AIR Z17**  
**AIR Z23**  
**AIR Z29**  
**AIR Z36**  
**AIR Z48**

**dimensions in mm**

**AIR Z**

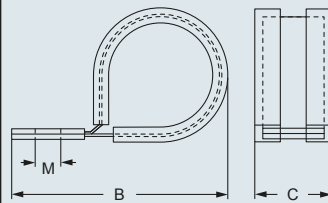

part No.	B	C	M
<b>AIR Z12</b>	29	12	M 4
<b>AIR Z17</b>	39	16	M 5
<b>AIR Z23</b>	47	16	M 5
<b>AIR Z29</b>	60	19	M 6
<b>AIR Z36</b>	70	19	M 6
<b>AIR Z48</b>	85	19	M 6

dimensions shown are not binding  
and may be changed without notice

## AIR B:

- used between the fitting and a flat surface, it guarantees IP68 degree of protection according to EN 60529
- temperature range -40 °C / +200 °C

## AIR G:

- O-ring gasket in NBR 70
- temperature range -30 °C / +100 °C
- inserted in flexible tubes, it guarantees IP68 degree of protection according to EN 60529

## gaskets for fitting base

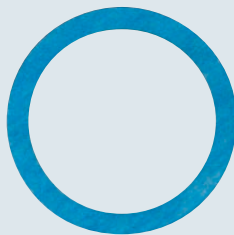

## O-ring gaskets for flexible tubes

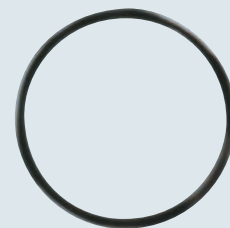

description	part No.	Pg or M threading	part No.
- for Pg 11 fittings	<b>AIR B11</b>	Pg 11	
- for Pg 13,5 fittings	<b>AIR B13</b>	Pg 13,5	
- for Pg 16 fittings	<b>AIR B16</b>	Pg 16	
- for Pg 21 fittings	<b>AIR B21</b>	Pg 21	
- for Pg 29 fittings	<b>AIR B29</b>	Pg 29	
- for Pg 36 fittings	<b>AIR B36</b>	Pg 36	
- for Pg 48 fittings	<b>AIR B48</b>	Pg 48	
- for M 20 fittings	<b>AIR B20</b>	M 20	
- for M 25 fittings	<b>AIR B25</b>	M 25	
- for M 32 fittings	<b>AIR B32</b>	M 32	
- for M 40 fittings	<b>AIR B40</b>	M 40	
- for M 50 fittings	<b>AIR B50</b>	M 50	
O-ring gasket			<b>AIR G12</b>
- nominal Ø 12			<b>AIR G17</b>
- nominal Ø 17			<b>AIR G23</b>
- nominal Ø 23			<b>AIR G29</b>
- nominal Ø 29			<b>AIR G36</b>
- nominal Ø 36			<b>AIR G48</b>
- nominal Ø 48			

## dimensions in mm

### AIR B

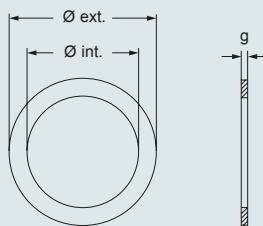

part No.	Pg	Ø int.	Ø ext.	g
<b>AIR B13</b>	11	18,6	26	1,5
<b>AIR B13</b>	13,5	20,4	29	1,5
<b>AIR B16</b>	16	22,5	33	1,5
<b>AIR B21</b>	21	28,3	39	1,5
<b>AIR B29</b>	29	37	49	1,5
<b>AIR B36</b>	36	47	59	1,5
<b>AIR B48</b>	48	59,3	71	1,5

part No.	M	Ø int.	Ø ext.	g
<b>AIR B20</b>	20x1,5	20	27	1,5
<b>AIR B25</b>	25x1,5	25	35	1,5
<b>AIR B32</b>	32x1,5	32	43	1,5
<b>AIR B40</b>	40x1,5	40	55	1,5
<b>AIR B50</b>	50x1,5	50	69	1,5

dimensions shown are not binding  
and may be changed without notice

## ASR B:

- used between the fitting and a flat surface, it guarantees IP68 degree of protection according to EN 60529
- temperature range -40 °C / +100 °C

## ARG:

- O-ring gasket in NBR
- temperature range -25 °C / +120 °C
- used between the fitting and a flat surface, it guarantees IP68 degree of protection according to EN 60529

## gaskets for fitting base



## O-ring gaskets

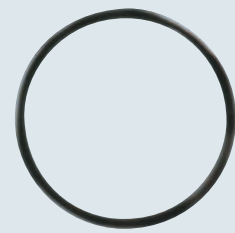

description	part No.	Pg or M threading	part No.	Pg or M threading
- for Pg 11 fittings - for Pg 13,5 fittings - for Pg 16 fittings - for Pg 21 fittings - for Pg 29 fittings - for Pg 36 fittings - for Pg 42 fittings	<b>ASR B11</b> <b>ASR B13</b> <b>ASR B16</b> <b>ASR B21</b> <b>ASR B29</b> <b>ASR B36</b> <b>ASR B42</b>	Pg 11 Pg 13,5 Pg 16 Pg 21 Pg 29 Pg 36 Pg 42		
- for M 20 fittings - for M 25 fittings - for M 32 fittings - for M 40 fittings - for M 50 fittings	<b>ASR B20</b> <b>ASR B25</b> <b>ASR B32</b> <b>ASR B40</b> <b>ASR B50</b>	M 20 M 25 M 32 M 40 M 50		
O-ring gasket - for Pg 11 and M 20 fittings - for Pg 13,5 fittings - for Pg 16 fittings - for Pg 21 fittings - for Pg 29 fittings - for Pg 36 fittings - for Pg 42 fittings			<b>ARG 11/20</b> <b>ARG 13</b> <b>ARG 16</b> <b>ARG 21</b> <b>ARG 29</b> <b>ARG 36</b> <b>ARG 42</b>	Pg 11 - M 20 Pg 13,5 Pg 16 Pg 21 Pg 29 Pg 36 Pg 42
O-ring gasket - for M 25 fittings - for M 32 fittings - for M 40 fittings - for M 50 fittings			<b>ARG 25</b> <b>ARG 32</b> <b>ARG 40</b> <b>ARG 50</b>	M 25 M 32 M 40 M 50

dimensions in mm

### ASR B

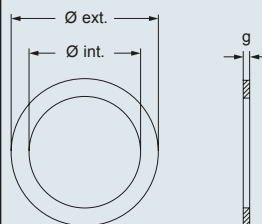

part No.	Pg	Ø int.	Ø ext.	g
<b>ASR B11</b>	11	17,1	23	1,2
<b>ASR B13</b>	13,5	19	25	1,2
<b>ASR B16</b>	16	21	27	1,2
<b>ASR B21</b>	21	26,6	34	1,5
<b>ASR B29</b>	29	35,2	45	1,5
<b>ASR B36</b>	36	45,2	56	1,5
<b>ASR B42</b>	42	52,2	67	1,5

part No.	M	Ø int.	Ø ext.	g
<b>ASR B20</b>	20	18	24	1,2
<b>ASR B25</b>	25	23	30	1,2
<b>ASR B32</b>	32	30	40	1,5
<b>ASR B40</b>	40	38	48	1,5
<b>ASR B50</b>	50	48	58	1,5

dimensions in mm

### ARG

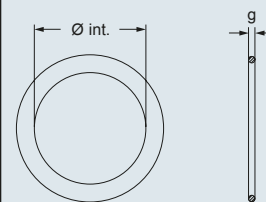

part No.	Pg	Ø int.	g
<b>ARG 11/20</b>	11	17,17	1,78
<b>ARG 13</b>	13,5	18,77	1,78
<b>ARG 16</b>	16	20,35	1,78
<b>ARG 21</b>	21	26,65	2,62
<b>ARG 29</b>	29	36,14	2,62
<b>ARG 36</b>	36	45,69	2,62
<b>ARG 42</b>	42	52,07	2,62

part No.	M	Ø int.	g
<b>ARG 11/20</b>	20	17,17	1,78
<b>ARG 25</b>	25	21,95	1,78
<b>ARG 32</b>	32	29,82	2,62
<b>ARG 40</b>	40	37,77	2,62
<b>ARG 50</b>	50	47,3	2,62

dimensions shown are not binding and may be changed without notice



**Headquarters****ILME S.p.A.**

Via Marco Antonio Colonna, 9  
20149 Milano - Italy  
T +39 02345605.22 - F +39 02331058.13  
www.ilme.com

**France****ILME FRANCE S.A.R.L.**

Rue Roland Garros  
Parc d'Activités de l'Aéroport  
42160 Andrézieux-Bouthéon  
T +33 (0) 4 77 36 23 36 - F +33 (0) 4 77 36 97 97  
ilme-france@ilme.fr  
www.ilme.fr

**Germany****ILME GmbH**

Max-Planck-Straße 12  
51674 Wiehl  
T +49 (0)2261 - 7955-0 - F +49 (0)2261 - 7955-5  
technik@ilme.de  
www.ilme.de

**Sweden  
and Nordic Countries****ILME NORDIC AB**

Transportvägen 18  
24642 Löddeköpinge  
T +46 46 18 28 00 - F +46 46 18 28 10  
info@ilme.se  
www.ilme.se

**United Kingdom****ILME UK LIMITED**

50 Evans Road, Venture Point  
Speke, Merseyside L24 9PB  
T +44 (0) 151 3369321 - F +44 (0) 151 3369326  
sales@ilmeuk.co.uk  
www.ilmeuk.co.uk

**China****ILME CHINA CO. LTD.**

Room 307, D area, No. 245,  
Xin Jun Huan Road, MinHang Dis  
201114 Shanghai  
T +86 21 6248 9961 - F +86 21 3478 8067  
info@ilmechina.com  
www.ilmechina.com

**Japan****ILME JAPAN CO. LTD.**

Kobe International Business Center - 650-0047, 5-2, 5 - Chome,  
Minatojima Minami-Machi - Chuo-Ku, Kobe  
T +81 7830 22005 - F +81 7830 22060  
info@ilmejapan.co.jp  
www.ilme.jp

www.ilme.com

XDG AS 1219



Catalogues



## X-ON Electronics

Largest Supplier of Electrical and Electronic Components

*Click to view similar products for [Conduit Fittings & Accessories](#) category:*

*Click to view products by [ILME](#) manufacturer:*

Other Similar products are found below :

[M3231GAB](#) [M3231GAC](#) [M3231GAE](#) [M3231GL](#) [M3231GN](#) [M3231GT](#) [VC-937-16/RED](#) [VC-1125-16/RED](#) [DM0240-1/2A](#) [3408B](#) [G6002](#)  
[M4340GAE](#) [G6003](#) [C2016-P](#) [C2012-P](#) [3407B](#) [1660-P](#) [561-87BG11BLK](#) [561-75BG11B](#) [1.511.1601.14](#) [1.533.1201.50](#) [1.533.1601.51](#)  
[1.533.2001.51](#) [1.533.4001.50](#) [1.533.5001.50](#) [BVBV-P366](#) [2276](#) [2663-P](#) [3405B](#) [C2070-P](#) [3582V](#) [2643-P](#) [4975](#) [2644-P](#) [2955](#) [M50](#) [2404-P](#)  
[C2008-P](#) [2723-P](#) [2291](#) [2133-P](#) [3048F](#) [VC12516](#) [RC156-0500](#) [DM0523-1/2A](#) [1035A](#) [DMS0250-1A](#) [DMS0313-1A](#) [1040A](#) [1050A](#) [R1/8A](#)