

General characteristics

This chapter explains the technical characteristics of the PLUSO series plugs and socket-outlets for industrial purposes.

The range of products covers a wide number of different installation requirements.

The plugs and socket-outlets are suitable for fixed or mobile installations. The fixed plugs and socket-outlets may be wall or flush-mounted.

Thanks to the wide range of the ILME enclosures of the FM, FC and BK series (types BC...) the flush-mounting plugs and socket-outlets can be assembled rapidly in a group configuration.

These construction features enable ILME plugs and socket-outlets to be suitable for use in the most demanding applications:

- the mechanical industry
- the shipbuilding industry
- the chemical and petrochemical industry
- the services sector
- the building industry
- the agricultural and livestock breeding sector

The following parameters must be considered when selecting the correct type of plugs and socket-outlets:

- rated current of the device to feed through plug and socket-outlet coupling;
- the rated voltage of the power supply and the type of distribution (single phase or three-phase, with or without the neutral conductor) to determine the number of poles for the hour position.
The hour position "1h" is available for all those voltages or voltage ranges > 50V and for frequencies or ranges of frequencies not covered by the standards.
- The type of installation (fixed or mobile) to determine the construction type of the plug and socket (flush-mounting straight or inclined, wall, mobile, mobile angled).
- The location of the installation to determine the degree of protection required (IP44 or IP67) and the voltage (in some areas the installation standards require very low safety voltage).

The following types of plugs and socket-outlets are available:

- wall-mounting plugs and socket-outlets (low and extra-low voltage).
- plugs and socket-outlets and straight flush-mounting socket-outlets (low and extra-low voltage).
- plugs and inclined flush-mounting socket-outlets (low voltage)
- straight plugs and couplers (low and extra-low voltage).
- angled plugs (low voltage).
- 5-pole plugs with phase inverter (low voltage, SIP type).
- 5-pole single-block plugs and socket-outlets (low voltage, PEM type) for automated cabling.

Electrical Features

rated frequency:

0 Hz (direct current), and from 50 Hz to 500 Hz

rated operating voltage:

the standard identifies two main types of use:

- extra-low voltage socket-outlets (and relative plugs), (SELV safety requirements, in accordance with the CEI 64-8 installation standard), for effective voltage values of up to 50V inclusive
- low voltage socket-outlets (and plugs) for effective voltage values of over 50V and up to 690V

polarity:

the versions are designed with:

- 2 and 3 poles (extra-low voltage: 2P, 3P)
- 3, 4 and 5 poles (low voltage: 2P+⊕, 3P+⊕, 3P+N+⊕)

The 63A and 125A plugs and socket-outlets have an additional pilot contact.

rated current:

with 16A, 32A, 63A and 125A values (low voltage)
with 16A and 32A (extra-low voltage).

rated insulation voltage:

- 690V for low voltage plugs and socket-outlets
- 50V for extra-low voltage plugs and socket-outlets
- minimum surface insulation distance: 10 mm (EN 60309-1)
- minimum air insulation distance: 8 mm (for rated operating voltages higher than 500V)

breaking capacity:

1.25 times greater than the rated current value (test performed at a voltage of 1.1 times the operating voltage).

Mechanical features

- **mechanical resistance**
verified with the provisions of Article 24 of the EN 60309-1 standard (IEC 60309-1)
- **resistance to chemical agents**
see Table on page 8
- **degree of protection**
IP44 and IP67 according to EN 60529 (see information on page 7)
- **resistance to glow-wire**
in accordance with standard IEC 60695 -1-2: for enclosures: 960 °C, 850 °C and 750 °C;
for inserts: 960 °C
- **temperatures**
ambient: -25 °C ÷ +40 °C; materials limit: -40 °C ÷ +125 °C
- **self-extinguishing capacity**
classification UL 94:
for enclosures **V2 e HB**;
for 16A, 32A and 63A type inserts, **V2**;
for types 125A, **5VA e VO**

Materials

- enclosures and inserts in self-extinguishing insulating thermoplastic material
- anti-aging elastomer gaskets
- brass pins (nickel-plated for the 63A and 125A plugs and socket-outlets, on request for the 16A and 32A plugs and socket-outlets)
- self-centring brass contact tubes with zinc-plated steel spring
- zinc-plated steel assembly screws (stainless steel for the 63A and 125A socket-outlets)
- terminals with zinc-plated screws retained in their seats when unscrewed
- 32A, 63A and 125A plugs and socket-outlets with two fixing screws in the terminals as protection against accidental loss
- 63A and 125A plugs and socket-outlets terminals with zinc-plated steel plate for wire protection

The supply package

Plugs and socket-outlets are supplied with:

- anti-oil and anti-aging gaskets
- self-threading fixing screws

The following is available on request:

- cable glands, gaskets, lock nuts and sealing plugs for wall-mounting plugs and socket-outlets
- FM, FC and BK (types BC...) ILME enclosures for flush-mounting plugs and socket-outlets



Composition of the part No.: e.g. **PEW 125 12 3 PP**
 (low voltage)
 article series _____
 rated current in amperes _____
 earthing contact position in hours _____
 number of poles + earth _____
 design of plug or socket _____

PE (IP44) and PEW (IP67) socket-outlets and couplers

low voltage over 50V up to 690V

	wall-mounting socket-outlets		straight flush-mounting socket-outlets		inclined flush-mounting socket-outlets		couplers	
IP67								
IP44								
	PE...PP page 14	PEW...PP page 15	PE...PQ page 16	PEW...PQ page 17	PE...PI page 18	PEW...PI page 19	PE...PV page 20	PEW...PV page 21
	16A 32A	16A 32A 63A 125A	16A 32A	16A 32A 63A 125A	16A 32A	16A 32A 63A 125A	16A 32A	16A 32A 63A 125A
	2P+⊕ 3P+⊕ 3P+N+⊕	2P+⊕ 3P+⊕ 3P+N+⊕	2P+⊕ 3P+⊕ 3P+N+⊕	2P+⊕ 3P+⊕ 3P+N+⊕	2P+⊕ 3P+⊕ 3P+N+⊕	2P+⊕ 3P+⊕ 3P+N+⊕	2P+⊕ 3P+⊕ 3P+N+⊕	2P+⊕ 3P+⊕ 3P+N+⊕

PE (IP44) and PEW (IP67) plugs

low voltage over 50V up to 690V

	wall-mounting inlets		appliance inlets		plugs		90° plugs	
IP67								
IP44								
	PE...SM page 22	PEW...SM page 23	PE...SI page 24	PEW...SI page 25	PE...SV page 26	PEW...SV page 27	PE...SA page 28	PEW...SA page 29
	16A 32A	16A 32A 63A 125A	16A 32A	16A 32A 63A 125A	16A 32A	16A 32A 63A 125A	16A 32A	16A 32A
	2P+⊕ 3P+⊕ 3P+N+⊕	2P+⊕ 3P+⊕ 3P+N+⊕	2P+⊕ 3P+⊕ 3P+N+⊕	2P+⊕ 3P+⊕ 3P+N+⊕	2P+⊕ 3P+⊕ 3P+N+⊕	2P+⊕ 3P+⊕ 3P+N+⊕	2P+⊕ 3P+⊕ 3P+N+⊕	2P+⊕ 3P+⊕ 3P+N+⊕

Composition of the part No.: e.g. **PB 16 12 2 PV**
(extra-low voltage)

article series _____
rated current in amperes _____
auxiliary reference in hours _____
number of poles _____
design of plug or socket _____

PEM single-block plugs, socket-outlets and couplers

low voltage over 200V up to 415V

wall-mounting socket-outlets

flush-mounting socket-outlets

couplers

plugs

IP44

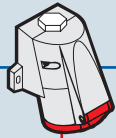

PEM...PP
page 30

16A
32A

3P+N+⊕

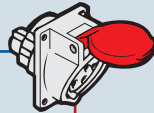

PEM...PI
page 30

16A
32A

3P+N+⊕

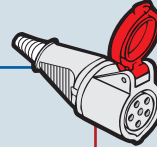

PEM...PV
page 31

16A
32A

3P+N+⊕

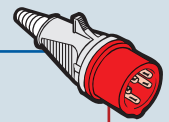

PEM...SV
page 31

16A
32A

3P+N+⊕

phase inverters type SIP (IP44) and SIPW (IP67)

low voltage over 200V up to 415V

wall-mounting phase inverters

flush-mounting phase inverters

phase inverters

IP67

IP44



SIP...SM
page 32

16A
32A

3P+N+⊕

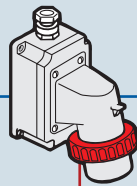

SIPW...SM
page 32

16A
32A

3P+N+⊕



SIP...SI
page 33

16A
32A

3P+N+⊕

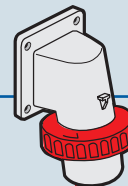

SIPW...SI
page 33

16A
32A

3P+N+⊕

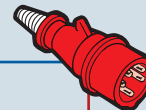

SIP...SV
page 33

16A
32A

3P+N+⊕

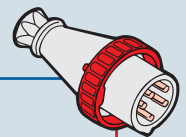

SIPW...SV
page 33

16A
32A

3P+N+⊕

PB plugs and socket-outlets

extra-low voltage up to 50V

wall-mounting socket-outlets

flush-mounting socket-outlets

couplers

appliance inlets

plugs

IP44



PB...PP
page 34

16A
32A

2P
3P

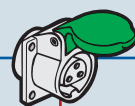

PB...PI
page 35

16A
32A

2P
3P

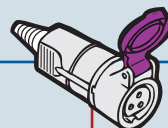

PB...PV
page 35

16A
32A

2P
3P



PB...SM
page 36

16A
32A

2P
3P

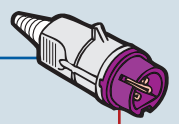

PB...SV
page 37

16A
32A

2P
3P

- Compliant with EN 60309-1 and -2
- Enclosure, insert and spring lid in insulating, thermoplastic, self-extinguishing material
- RAL 7035 grey enclosure, spring lid colour coded according to the operating voltage
- PE...PP types (IP44), spring lid, entry with threaded grommet (replaceable with a cable gland)
- PEW...PP types (IP67), spring lid with locking ring and gasket, entry with cable gland
- Terminals with retained screws
- 63A, 125A: with pilot contact
- Nickel-plated contacts, available on request for 16A and 32A (standard on 63A and 125A)**
- 125A: with terminal block for the anchoring of incoming cables, already connected to socket
- IP44 and IP67 degree of protection (EN 60529)
- With Italian Quality Mark

16A
IP44 degree of protection



32A
IP44 degree of protection



Poles	Frequency Hz	Voltage V	Earthing contact position h	Part No.	Colour	Part No.	Colour	
2P+	50 and 60	100 - 130	4	PE 1643 PP		PE 3243 PP		
	50 and 60	200 - 250	6	PE 1663 PP		PE 3263 PP		
	50 and 60	380 - 415	9	PE 1693 PP		PE 3293 PP		
	50 and 60	480 - 500	7	PE 1673 PP		PE 3273 PP		
	50 and 60	ins. transformer	12	PE 16123 PP	A.V.	PE 32123 PP	A.V.	
	> 300 - 500	> 50	2	PE 1623 PP		PE 3223 PP		
	d.c.	> 50 - 250	3	PE 1633 PP	A.V.	PE 3233 PP	A.V.	
	d.c.	> 250	8	PE 1683 PP	A.V.	PE 3283 PP	A.V.	
	3P+	50 and 60	100 - 130	4	PE 1644 PP		PE 3244 PP	
		50 and 60	200 - 250	9	PE 1694 PP		PE 3294 PP	
50 and 60		380 - 415	6	PE 1664 PP		PE 3264 PP		
60		440 - 460	11	PE 16114 PP		PE 32114 PP		
50 and 60		480 - 500	7	PE 1674 PP		PE 3274 PP		
50 and 60		600 - 690	5	PE 1654 PP		PE 3254 PP		
50		380	3	PE 1634 PP		PE 3234 PP		
60		440	3	PE 1634 PP		PE 3234 PP		
100 - 300		> 50	10	PE 16104 PP		PE 32104 PP		
> 300 - 500		> 50	2	PE 1624 PP		PE 3224 PP		
3P+N+	50 and 60	57/100 - 75/130	4	PE 1645 PP		PE 3245 PP		
	50 and 60	120/208 - 144/250	9	PE 1695 PP		PE 3295 PP		
	50 and 60	200/346 - 240/415	6	PE 1665 PP		PE 3265 PP		
	50 and 60	277/480 - 288/500	7	PE 1675 PP		PE 3275 PP		
	50 and 60	347/600 - 400/690	5	PE 1655 PP		PE 3255 PP		
	60	250/400 - 265/460	11	PE 16115 PP		PE 32115 PP		
	50	220/380	3	PE 1635 PP		PE 3235 PP		
	60	250/440	3	PE 1635 PP		PE 3235 PP		
	> 300 - 500	> 50	2	PE 1625 PP		PE 3225 PP		

Legend

A.V. = Colour according to voltage

(*) Green may be used together with the colour of the operating range for frequencies above 60 Hz and up to a maximum of 500 Hz.

(**) For the code of products with nickel-plated contacts (socket holes, plug pins), add "N" to the pre-code of the corresponding standard product code; for example: PE becomes PEN and PEW becomes PEWN.

Dimensions in mm

(16 / 32A) PE ... PP

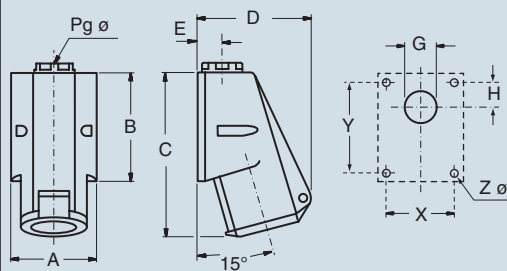

PE ... PP	A	B	C	D	E	G	H	X	Y	Pg ø	Z ø	
16A	2P+	70	82	126	92	20	Ø22	16	53	65	16	4.5
	3P+	70	82	126	92	20	Ø22	16	53	65	16	4.5
	3P+N+	70	82	126	99	13	Ø22	16	53	65	16	4.5
32A	2P+	86	104	159	110	24	Ø28	17	61	79	21	6.5
	3P+	86	104	159	110	24	Ø28	17	61	79	21	6.5
	3P+N+	86	104	159	110	24	Ø28	17	61	79	21	6.5

Dimensions indicated are not binding and may be changed without prior notice.

16A
IP67 degree of protection



32A
IP67 degree of protection



63A
IP67 degree of protection



125A
IP67 degree of protection



Part No.	Colour	Part No.	Colour	Part No.	Colour	Part No.	Colour
PEW 1643 PP ⊕	Yellow	PEW 3243 PP ⊕	Yellow	PEW 6343 PP ⊕	Yellow	PEW 12543 PP ⊕	Yellow
PEW 1663 PP ⊕	Blue	PEW 3263 PP ⊕	Blue	PEW 6363 PP ⊕	Blue	PEW 12563 PP ⊕	Blue
PEW 1693 PP ⊕	Red	PEW 3293 PP ⊕	Red	PEW 6393 PP ⊕	Red	PEW 12593 PP ⊕	Red
PEW 1673 PP ⊕	Black	PEW 3273 PP ⊕	Black	PEW 6373 PP ⊕	Black	PEW 12573 PP ⊕	Black
PEW 16123 PP ⊕	A.V.	PEW 32123 PP ⊕	A.V.	PEW 63123 PP ⊕	A.V.	PEW 125123 PP ⊕	A.V.
PEW 1623 PP ⊕	(+)	PEW 3223 PP ⊕	(+)	PEW 6323 PP ⊕	(+)	PEW 12523 PP ⊕	(+)
PEW 1633 PP ⊕	A.V.	PEW 3233 PP ⊕	A.V.	PEW 6333 PP	A.V.	PEW 12533 PP	A.V.
PEW 1683 PP	A.V.	PEW 3283 PP	A.V.	PEW 6383 PP	A.V.	PEW 12583 PP	A.V.
PEW 1644 PP ⊕	Yellow	PEW 3244 PP ⊕	Yellow	PEW 6344 PP ⊕	Yellow	PEW 12544 PP ⊕	Yellow
PEW 1694 PP ⊕	Blue	PEW 3294 PP ⊕	Blue	PEW 6394 PP ⊕	Blue	PEW 12594 PP ⊕	Blue
PEW 1664 PP ⊕	Red	PEW 3264 PP ⊕	Red	PEW 6364 PP ⊕	Red	PEW 12564 PP ⊕	Red
PEW 16114 PP ⊕	Black	PEW 32114 PP ⊕	Black	PEW 63114 PP ⊕	Black	PEW 125114 PP ⊕	Black
PEW 1674 PP ⊕	Black	PEW 3274 PP ⊕	Black	PEW 6374 PP ⊕	Black	PEW 12574 PP ⊕	Black
PEW 1654 PP	Black	PEW 3254 PP	Black	PEW 6354 PP	Black	PEW 12554 PP	Black
PEW 1634 PP ⊕	Red	PEW 3234 PP ⊕	Red				
PEW 1634 PP ⊕	Red	PEW 3234 PP ⊕	Red				
PEW 16104 PP ⊕	(+)	PEW 32104 PP ⊕	(+)				
PEW 1624 PP ⊕	(+)	PEW 3224 PP ⊕	(+)				
PEW 1645 PP ⊕	Yellow	PEW 3245 PP ⊕	Yellow	PEW 6345 PP ⊕	Yellow	PEW 12545 PP ⊕	Yellow
PEW 1695 PP ⊕	Blue	PEW 3295 PP ⊕	Blue	PEW 6395 PP ⊕	Blue	PEW 12595 PP ⊕	Blue
PEW 1665 PP ⊕	Red	PEW 3265 PP ⊕	Red	PEW 6365 PP ⊕	Red	PEW 12565 PP ⊕	Red
PEW 1675 PP ⊕	Black	PEW 3275 PP ⊕	Black	PEW 6375 PP ⊕	Black	PEW 12575 PP ⊕	Black
PEW 1655 PP	Black	PEW 3255 PP	Black	PEW 6355 PP	Black	PEW 12555 PP	Black
PEW 16115 PP ⊕	Red	PEW 32115 PP ⊕	Red	PEW 63115 PP ⊕	Red	PEW 125115 PP ⊕	Red
PEW 1635 PP ⊕	Red	PEW 3235 PP ⊕	Red				
PEW 1635 PP ⊕	Red	PEW 3235 PP ⊕	Red				
PEW 1625 PP ⊕	(+)	PEW 3225 PP ⊕	(+)				

Dimensions in mm

(16 / 32A) PEW ... PP

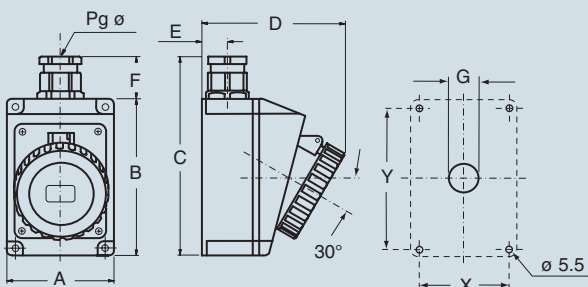

PEW ... PP	A	B	C	D	E	F	G	X	Y	Pg ø
16A 2P+⊕	75	115	150	105	19	33	Ø22	65	105	16
3P+⊕	75	115	150	108	19	33	Ø22	65	105	16
3P+N+⊕	100	130	172	120	22	33	Ø22	85	115	21
32A 2P+⊕	100	130	172	120	22	42	Ø28	85	115	21
3P+⊕	100	130	172	120	22	42	Ø28	85	115	21
3P+N+⊕	100	130	172	120	22	42	Ø28	85	115	21

Dimensions in mm

(63A) PEW ... PP

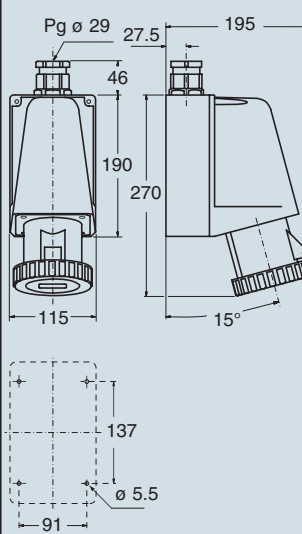

(125A) PEW ... PP

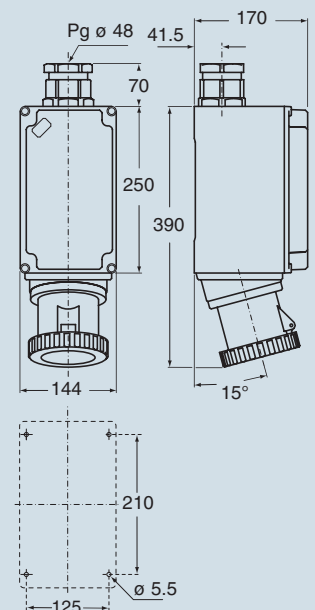

- Compliant with EN 60309-1 and -2
- Enclosure, insert and spring lid in insulating, thermoplastic, self-extinguishing material
- RAL 7035 grey enclosure, spring lid colour coded according to the operating voltage
- Flange with anti-ageing gasket
- PE...PQ types (IP44), spring lid
- PEW...PQ types (IP67), spring lid with locking ring and gasket
- Terminals with retained screws
- 63A, 125A: with pilot contact
- Nickel-plated contacts, available on request for 16A and 32A (standard on 63A and 125A)**
- IP44 and IP67 degrees of protection (EN 60529)
- With Italian Quality Mark

16A
IP44 degree of protection



32A
IP44 degree of protection

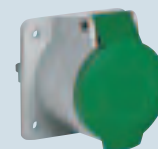

Poles	Frequency Hz	Voltage V	Earthing contact position h	Part No.	Colour	Part No.	Colour
2P+⊕	50 and 60	100 - 130	4	PE 1643 PQ		PE 3243 PQ	
	50 and 60	200 - 250	6	PE 1663 PQ		PE 3263 PQ	
	50 and 60	380 - 415	9	PE 1693 PQ		PE 3293 PQ	
	50 and 60	480 - 500	7	PE 1673 PQ		PE 3273 PQ	
	50 and 60	ins. transformer	12	PE 16123 PQ	A.V.	PE 32123 PQ	A.V.
	> 300 - 500	> 50	2	PE 1623 PQ		PE 3223 PQ	
	d.c.	> 50 - 250	3	PE 1633 PQ	A.V.	PE 3233 PQ	A.V.
	d.c.	> 250	8	PE 1683 PQ	A.V.	PE 3283 PQ	A.V.
3P+⊕	50 and 60	100 - 130	4	PE 1644 PQ		PE 3244 PQ	
	50 and 60	200 - 250	9	PE 1694 PQ		PE 3294 PQ	
	50 and 60	380 - 415	6	PE 1664 PQ		PE 3264 PQ	
	60	440 - 460	11	PE 16114 PQ		PE 32114 PQ	
	50 and 60	480 - 500	7	PE 1674 PQ		PE 3274 PQ	
	50 and 60	600 - 690	5	PE 1654 PQ		PE 3254 PQ	
	50	380	3	PE 1634 PQ		PE 3234 PQ	
	60	440	3	PE 1634 PQ		PE 3234 PQ	
	100 - 300	> 50	10	PE 16104 PQ		PE 32104 PQ	
	> 300 - 500	> 50	2	PE 1624 PQ		PE 3224 PQ	
3P+N+⊕	50 and 60	57/100 - 75/130	4	PE 1645 PQ		PE 3245 PQ	
	50 and 60	120/208 - 144/250	9	PE 1695 PQ		PE 3295 PQ	
	50 and 60	200/346 - 240/415	6	PE 1665 PQ		PE 3265 PQ	
	50 and 60	277/480 - 288/500	7	PE 1675 PQ		PE 3275 PQ	
	50 and 60	347/600 - 400/690	5	PE 1655 PQ		PE 3255 PQ	
	60	250/440 - 265/460	11	PE 16115 PQ		PE 32115 PQ	
	50	220/380	3	PE 1635 PQ		PE 3235 PQ	
	60	250/440	3	PE 1635 PQ		PE 3235 PQ	
	> 300 - 500	> 50	2	PE 1625 PQ		PE 3225 PQ	

Legend

A.V. = Colour according to voltage

(*) Green may be used together with the colour of the operating range for frequencies above 60 Hz and up to a maximum of 500 Hz.

(**) For the code of products with nickel-plated contacts (socket holes, plug pins), add "N" to the pre-code of the corresponding standard product code; for example: PE becomes PEN and PEW becomes PEWN.

Dimensions in mm

(16 / 32A) PE ... PQ

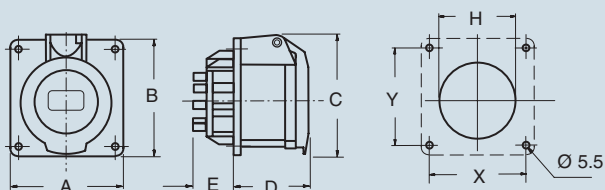

PE...PQ	A	B	C	D	E	H	X	Y
16A	2P+⊕	65	65	71	52	27	60	52
	3P+⊕	65	65	75	53	27	61.5	52
	3P+N+⊕	80	80	86	53	27	70	60
32A	2P+⊕	80	80	87	62	28	68	60
	3P+⊕	80	80	87	62	28	68	60
	3P+N+⊕	80	80	92	62	28	73	60

Dimensions indicated are not binding and may be changed without prior notice.

PEW...PQ flush-mounting straight socket-outlets, low voltage from over 50V up to 690V



16A
IP67 degree of protection



32A
IP67 degree of protection



63A
IP67 degree of protection



125A
IP67 degree of protection



PEW...PQ

Part No.	Colour	Part No.	Colour	Part No.	Colour	Part No.	Colour
PEW 1643 PQ ⊕	Yellow	PEW 3243 PQ ⊕	Yellow	PEW 6343 PQ ⊕	Yellow	PEW 12543 PQ ⊕	Yellow
PEW 1663 PQ ⊕	Blue	PEW 3263 PQ ⊕	Blue	PEW 6363 PQ ⊕	Blue	PEW 12563 PQ ⊕	Blue
PEW 1693 PQ ⊕	Red	PEW 3293 PQ ⊕	Red	PEW 6393 PQ ⊕	Red	PEW 12593 PQ ⊕	Red
PEW 1673 PQ ⊕	Black	PEW 3273 PQ ⊕	Black	PEW 6373 PQ ⊕	Black	PEW 12573 PQ ⊕	Black
PEW 16123 PQ ⊕	A.V.	PEW 32123 PQ ⊕	A.V.	PEW 63123 PQ ⊕	A.V.	PEW 125123 PQ ⊕	A.V.
PEW 1623 PQ ⊕	(+)	PEW 3223 PQ ⊕	(+)				
PEW 1633 PQ ⊕	A.V.	PEW 3233 PQ	A.V.	PEW 6333 PQ	A.V.	PEW 12533 PQ	A.V.
PEW 1683 PQ	A.V.	PEW 3283 PQ	A.V.	PEW 6383 PQ	A.V.	PEW 12583 PQ	A.V.
PEW 1644 PQ ⊕	Yellow	PEW 3244 PQ ⊕	Yellow	PEW 6344 PQ ⊕	Yellow	PEW 12544 PQ ⊕	Yellow
PEW 1694 PQ ⊕	Blue	PEW 3294 PQ ⊕	Blue	PEW 6394 PQ ⊕	Blue	PEW 12594 PQ ⊕	Blue
PEW 1664 PQ ⊕	Red	PEW 3264 PQ ⊕	Red	PEW 6364 PQ ⊕	Red	PEW 12564 PQ ⊕	Red
PEW 16114 PQ ⊕	Red	PEW 32114 PQ ⊕	Red	PEW 63114 PQ ⊕	Red	PEW 125114 PQ ⊕	Red
PEW 1674 PQ ⊕	Black	PEW 3274 PQ ⊕	Black	PEW 6374 PQ ⊕	Black	PEW 12574 PQ ⊕	Black
PEW 1654 PQ	Black	PEW 3254 PQ	Black	PEW 6354 PQ	Black	PEW 12554 PQ	Black
PEW 1634 PQ ⊕	Red	PEW 3234 PQ ⊕	Red				
PEW 1634 PQ ⊕	Red	PEW 3234 PQ ⊕	Red				
PEW 16104 PQ ⊕	(+)	PEW 32104 PQ ⊕	(+)				
PEW 1624 PQ ⊕	(+)	PEW 3224 PQ ⊕	(+)				
PEW 1645 PQ ⊕	Yellow	PEW 3245 PQ ⊕	Yellow	PEW 6345 PQ ⊕	Yellow	PEW 12545 PQ ⊕	Yellow
PEW 1695 PQ ⊕	Blue	PEW 3295 PQ ⊕	Blue	PEW 6395 PQ ⊕	Blue	PEW 12595 PQ ⊕	Blue
PEW 1665 PQ ⊕	Red	PEW 3265 PQ ⊕	Red	PEW 6365 PQ ⊕	Red	PEW 12565 PQ ⊕	Red
PEW 1675 PQ ⊕	Black	PEW 3275 PQ ⊕	Black	PEW 6375 PQ ⊕	Black	PEW 12575 PQ ⊕	Black
PEW 1655 PQ	Black	PEW 3255 PQ	Black	PEW 6355 PQ	Black	PEW 12555 PQ	Black
PEW 16115 PQ ⊕	Red	PEW 32115 PQ ⊕	Red	PEW 63115 PQ ⊕	Red	PEW 125115 PQ ⊕	Red
PEW 1635 PQ ⊕	Red	PEW 3235 PQ ⊕	Red				
PEW 1635 PQ ⊕	Red	PEW 3235 PQ ⊕	Red				
PEW 1625 PQ ⊕	(+)	PEW 3225 PQ ⊕	(+)				

Dimensions in mm

(16 / 32A) PEW ... PQ

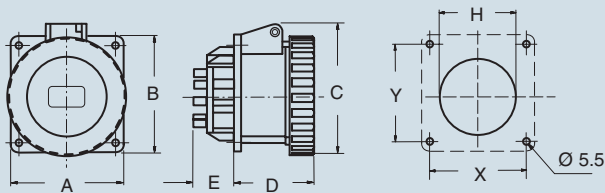

PEW...PQ	A	B	C	D	E	H	X	Y
16A 2P+⊕	65	65	77	52	27	60	52	52
3P+⊕	65	65	85	52	27	61.5	52	52
3P+N+⊕	80	80	93	52	27	70	60	60
32A 2P+⊕	80	80	98	62	28	68	60	60
3P+⊕	80	80	98	62	28	68	60	60
3P+N+⊕	80	80	105	62	28	73	60	60

Dimensions in mm

(63 / 125A) PEW ... PQ

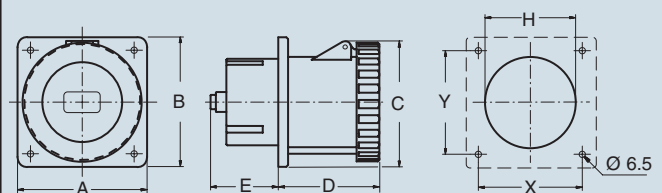

PEW ... PQ	A	B	C	D	E	H	X	Y
63A 2P+⊕	100	107	109	92	30	73	77	85
3P+⊕	100	107	109	92	30	73	77	85
3P+N+⊕	100	107	109	92	30	73	77	85
125A 2P+⊕	130	130	130	101	68	91	104	104
3P+⊕	130	130	130	101	68	91	104	104
3P+N+⊕	130	130	130	101	68	91	104	104

- Compliant with EN 60309-1 and -2
- Enclosure, insert and spring lid in insulating, thermoplastic, self-extinguishing material
- RAL 7035 grey enclosure, spring lid colour coded according to the operating voltage
- Flange with anti-ageing gasket
- PE...PI types (IP44), spring lid
- PEW...PI types (IP67), spring lid with locking ring and gasket
- Terminals with retained screws
- 63A, 125A: with pilot contact
- Nickel-plated contacts, available on request for 16A and 32A (standard on 63A and 125A)**
- IP44 and IP67 degrees of protection (EN 60529)
- With Italian Quality Mark

16A
IP44 degree of protection



32A
IP44 degree of protection

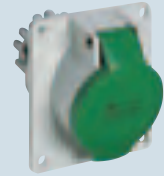

Number of poles	Frequency Hz	Voltage V	Earthing contact position h	Part No.	Colour	Part No.	Colour	
2P+⊕	50 and 60	100 - 130	4	PE 1643 PI		PE 3243 PI		
	50 and 60	200 - 250	6	PE 1663 PI		PE 3263 PI		
	50 and 60	380 - 415	9	PE 1693 PI		PE 3293 PI		
	50 and 60	480 - 500	7	PE 1673 PI		PE 3273 PI		
	50 and 60	ins. transformer	12	PE 16123 PI	A.V.	PE 32123 PI	A.V.	
	> 300 - 500	> 50	2	PE 1623 PI		PE 3223 PI		
	d.c.	> 50 - 250	3	PE 1633 PI	A.V.	PE 3233 PI	A.V.	
	d.c.	> 250	8	PE 1683 PI	A.V.	PE 3283 PI	A.V.	
	3P+⊕	50 and 60	100 - 130	4	PE 1644 PI		PE 3244 PI	
		50 and 60	200 - 250	9	PE 1694 PI		PE 3294 PI	
50 and 60		380 - 415	6	PE 1664 PI		PE 3264 PI		
60		440 - 460	11	PE 16114 PI		PE 32114 PI		
50 and 60		480 - 500	7	PE 1674 PI		PE 3274 PI		
50 and 60		600 - 690	5	PE 1654 PI		PE 3254 PI		
50		380	3	PE 1634 PI		PE 3234 PI		
60		440	3	PE 1634 PI		PE 3234 PI		
100 - 300		> 50	10	PE 16104 PI		PE 32104 PI		
> 300 - 500		> 50	2	PE 1624 PI		PE 3224 PI		
3P+N+⊕		50 and 60	57/100 - 75/130	4	PE 1645 PI		PE 3245 PI	
	50 and 60	120/208 - 144/250	9	PE 1695 PI		PE 3295 PI		
	50 and 60	200/346 - 240/415	6	PE 1665 PI		PE 3265 PI		
	50 and 60	277/480 - 288/500	7	PE 1675 PI		PE 3275 PI		
	50 and 60	347/600 - 400/690	5	PE 1655 PI		PE 3255 PI		
	60	250/440 - 265/460	11	PE 16115 PI		PE 32115 PI		
	50	220/380	3	PE 1635 PI		PE 3235 PI		
	60	250/440	3	PE 1635 PI		PE 3235 PI		
	> 300 - 500	> 50	2	PE 1625 PI		PE 3225 PI		

Legend

A.V. = Colour according to voltage

(*) Green may be used together with the colour of the operating range for frequencies above 60 Hz and up to a maximum of 500 Hz.

(**) For the code of products with nickel-plated contacts (socket holes, plug pins), add "N" to the pre-code of the corresponding standard product code; for example: PE becomes PEN and PEW becomes PEWN.

Dimensions in mm

(16 / 32A) PE ... PI

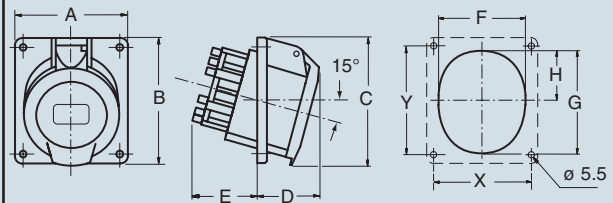

PE ... PI	A	B	C	D	E	F	G	H	X	Y	
16A	2P+⊕	64	82	82	38	46	52	62	30	52	60
	3P+⊕	64	82	82	42	47	57	65	28	52	60
	3P+N+⊕	92	100	100	43	47	66	78	37.5	77	85
32A	2P+⊕	92	100	100	40	55	68	76	35.5	77	85
	3P+⊕	92	100	100	40	55	68	76	35.5	77	85
	3P+N+⊕	92	102	102	43	55	74	86	39.5	77	85

Dimensions indicated are not binding and may be changed without prior notice.

PEW...PI flush-mounting inclined socket-outlets, low voltage from over 50V up to 690V



16A
IP67 degree of protection



32A
IP67 degree of protection



63A
IP67 degree of protection



125A
IP67 degree of protection

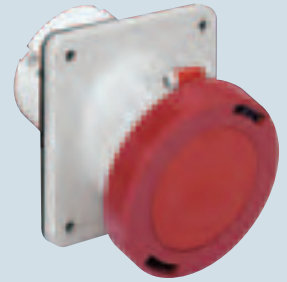

Part No.	Colour	Part No.	Colour	Part No.	Colour	Part No.	Colour
PEW 1643 PI ⊕	Yellow	PEW 3243 PI ⊕	Yellow	PEW 6343 PI ⊕	Yellow	PEW 12543 PI ⊕	Yellow
PEW 1663 PI ⊕	Blue	PEW 3263 PI ⊕	Blue	PEW 6363 PI ⊕	Blue	PEW 12563 PI ⊕	Blue
PEW 1693 PI ⊕	Red	PEW 3293 PI ⊕	Red	PEW 6393 PI ⊕	Red	PEW 12593 PI ⊕	Red
PEW 1673 PI ⊕	Black	PEW 3273 PI ⊕	Black	PEW 6373 PI ⊕	Black	PEW 12573 PI ⊕	Black
PEW 16123 PI ⊕	A.V.	PEW 32123 PI ⊕	A.V.	PEW 63123 PI ⊕	A.V.	PEW 125123 PI ⊕	A.V.
PEW 1623 PI ⊕	(+)	PEW 3223 PI ⊕	(+)				
PEW 1633 PI ⊕	A.V.	PEW 3233 PI	A.V.	PEW 6333 PI	A.V.	PEW 12533 PI	A.V.
PEW 1683 PI	A.V.	PEW 3283 PI	A.V.	PEW 6383 PI	A.V.	PEW 12583 PI	A.V.
PEW 1644 PI ⊕	Yellow	PEW 3244 PI ⊕	Yellow	PEW 6344 PI ⊕	Yellow	PEW 12544 PI ⊕	Yellow
PEW 1694 PI ⊕	Blue	PEW 3294 PI ⊕	Blue	PEW 6394 PI ⊕	Blue	PEW 12594 PI ⊕	Blue
PEW 1664 PI ⊕	Red	PEW 3264 PI ⊕	Red	PEW 6364 PI ⊕	Red	PEW 12564 PI ⊕	Red
PEW 16114 PI ⊕	Red	PEW 32114 PI ⊕	Red	PEW 63114 PI ⊕	Red	PEW 125114 PI ⊕	Red
PEW 1674 PI ⊕	Black	PEW 3274 PI ⊕	Black	PEW 6374 PI ⊕	Black	PEW 12574 PI ⊕	Black
PEW 1654 PI	Black	PEW 3254 PI	Black	PEW 6354 PI	Black	PEW 12554 PI	Black
PEW 1634 PI ⊕	Red	PEW 3234 PI ⊕	Red				
PEW 1634 PI ⊕	Red	PEW 3234 PI ⊕	Red				
PEW 16104 PI ⊕	(+)	PEW 32104 PI ⊕	(+)				
PEW 1624 PI ⊕	(+)	PEW 3224 PI ⊕	(+)				
PEW 1645 PI ⊕	Yellow	PEW 3245 PI ⊕	Yellow	PEW 6345 PI ⊕	Yellow	PEW 12545 PI ⊕	Yellow
PEW 1695 PI ⊕	Blue	PEW 3295 PI ⊕	Blue	PEW 6395 PI ⊕	Blue	PEW 12595 PI ⊕	Blue
PEW 1665 PI ⊕	Red	PEW 3265 PI ⊕	Red	PEW 6365 PI ⊕	Red	PEW 12565 PI ⊕	Red
PEW 1675 PI ⊕	Black	PEW 3275 PI ⊕	Black	PEW 6375 PI ⊕	Black	PEW 12575 PI ⊕	Black
PEW 1655 PI	Black	PEW 3255 PI	Black	PEW 6355 PI	Black	PEW 12555 PI	Black
PEW 16115 PI ⊕	Red	PEW 32115 PI ⊕	Red	PEW 63115 PI ⊕	Red	PEW 125115 PI ⊕	Red
PEW 1635 PI ⊕	Red	PEW 3235 PI ⊕	Red				
PEW 1635 PI ⊕	Red	PEW 3235 PI ⊕	Red				
PEW 1625 PI ⊕	(+)	PEW 3225 PI ⊕	(+)				

Dimensions in mm

(16 / 32A) PEW ... PI

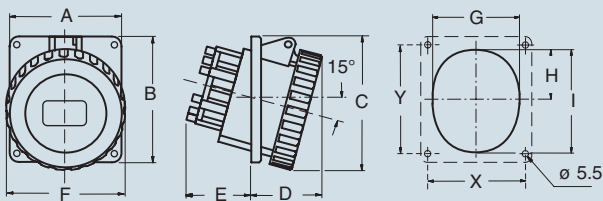

PEW ... PI	A	B	C	D	E	F	G	H	I	X	Y
16A 2P+⊕	65	82	83	48	35	70	50	29	58	52	60
3P+⊕	65	82	87	48	37	78	58	30	65	52	60
3P+N+⊕	90	100	102	50	38	86	66	35	75	77	85
32A 2P+⊕	90	100	116	50	50	92	68	37	78	77	85
3P+⊕	90	100	116	50	50	92	68	37	78	77	85
3P+N+⊕	90	100	118	50	50	100	73	42.5	86	77	85

Dimensions in mm

(63 / 125A) PEW ... PI

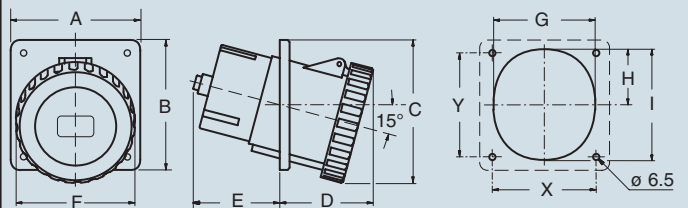

PEW ... PI	A	B	C	D	E	F	G	H	I	X	Y
63A 2P+⊕	100	107	124	84	55	107	82	45	94	77	85
3P+⊕	100	107	124	84	55	107	82	45	94	77	85
3P+N+⊕	100	107	124	84	55	107	82	45	94	77	85
125A 2P+⊕	130	130	143	94	87	119	102	56	112	104	104
3P+⊕	130	130	143	94	87	119	102	56	112	104	104
3P+N+⊕	130	130	143	94	87	119	102	56	112	104	104

PEW...PI

- Compliant with EN 60309-1 and -2
- Enclosure, insert and spring lid in insulating, thermoplastic, self-extinguishing material
- Cable anchoring collar incorporated in the insert
- PE...PV types (IP44), enclosure and spring lid colour coded according to operating voltage, entry with grommet
- PEW...PV (IP67) types, RAL 7035 grey enclosure, spring lid with locking ring and gasket colour coded according to operating voltage, entry with cable gland
- Terminals with retained screws
- 63A, 125A: with pilot contact
- Nickel-plated contacts, available on request for 16A and 32A (standard on 63A and 125A)**
- IP44 and IP67 degrees of protection (EN 60529)
- With Italian Quality Mark

16A
IP44 degree of protection



32A
IP44 degree of protection



Number of poles	Frequency Hz	Voltage V	Earthing contact position h	Part No.	Colour	Part No.	Colour	
2P+⊕	50 and 60	100 - 130	4	PE 1643 PV		PE 3243 PV		
	50 and 60	200 - 250	6	PE 1663 PV		PE 3263 PV		
	50 and 60	380 - 415	9	PE 1693 PV		PE 3293 PV		
	50 and 60	480 - 500	7	PE 1673 PV		PE 3273 PV		
	50 and 60	ins. transformer	12	PE 16123 PV	A.V.	PE 32123 PV	A.V.	
	> 300 - 500	> 50	2	PE 1623 PV		PE 3223 PV		
	d.c.	> 50 - 250	3	PE 1633 PV	A.V.	PE 3233 PV	A.V.	
	d.c.	> 250	8	PE 1683 PV	A.V.	PE 3283 PV	A.V.	
	3P+⊕	50 and 60	100 - 130	4	PE 1644 PV		PE 3244 PV	
		50 and 60	200 - 250	9	PE 1694 PV		PE 3294 PV	
50 and 60		380 - 415	6	PE 1664 PV		PE 3264 PV		
60		440 - 460	11	PE 16114 PV		PE 32114 PV		
50 and 60		480 - 500	7	PE 1674 PV		PE 3274 PV		
50 and 60		600 - 690	5	PE 1654 PV		PE 3254 PV		
50		380	3	PE 1634 PV		PE 3234 PV		
60		440	3	PE 1634 PV		PE 3234 PV		
100 - 300		> 50	10	PE 16104 PV		PE 32104 PV		
> 300 - 500		> 50	2	PE 1624 PV		PE 3224 PV		
3P+N+⊕		50 and 60	57/100 - 75/130	4	PE 1645 PV		PE 3245 PV	
	50 and 60	120/208 - 144/250	9	PE 1695 PV		PE 3295 PV		
	50 and 60	200/346 - 240/415	6	PE 1665 PV		PE 3265 PV		
	50 and 60	277/480 - 288/500	7	PE 1675 PV		PE 3275 PV		
	50 and 60	347/600 - 400/690	5	PE 1655 PV		PE 3255 PV		
	60	250/440 - 265/460	11	PE 16115 PV		PE 32115 PV		
	50	220/380	3	PE 1635 PV		PE 3235 PV		
	60	250/440	3	PE 1635 PV		PE 3235 PV		
	> 300 - 500	> 50	2	PE 1625 PV		PE 3225 PV		

Legend

A.V. = Colour according to voltage

(*) Green may be used together with the colour of the operating range for frequencies above 60 Hz and up to a maximum of 500 Hz.

(**) For the code of products with nickel-plated contacts (socket holes, plug pins), add "N" to the pre-code of the corresponding standard product code; for example: PE becomes PEN and PEW becomes PEWN.

Dimensions in mm

(16 / 32A) PE ... PV

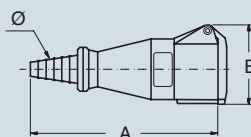

PE...PV	A	B	ø min	ø max	
16A	2P+⊕	157.5	68	7	17
	3P+⊕	164.5	76	7	17
	3P+N+⊕	183.5	83	9	22
32A	2P+⊕	200.5	87	9	22
	3P+⊕	200.5	87	9	22
	3P+N+⊕	200.5	91	9	22

Dimensions indicated are not binding and may be changed without prior notice.

16A
IP67 degree of protection



32A
IP67 degree of protection



63A
IP67 degree of protection



125A
IP67 degree of protection



PEW...PV

Part No.	Colour	Part No.	Colour	Part No.	Colour	Part No.	Colour
PEW 1643 PV ⊕	Yellow	PEW 3243 PV ⊕	Yellow	PEW 6343 PV ⊕	Yellow	PEW 12543 PV ⊕	Yellow
PEW 1663 PV ⊕	Blue	PEW 3263 PV ⊕	Blue	PEW 6363 PV ⊕	Blue	PEW 12563 PV ⊕	Blue
PEW 1693 PV ⊕	Red	PEW 3293 PV ⊕	Red	PEW 6393 PV ⊕	Red	PEW 12593 PV ⊕	Red
PEW 1673 PV ⊕	Black	PEW 3273 PV ⊕	Black	PEW 6373 PV ⊕	Black	PEW 12573 PV ⊕	Black
PEW 16123 PV ⊕	A.V.	PEW 32123 PV ⊕	A.V.	PEW 63123 PV ⊕	A.V.	PEW 125123 PV ⊕	A.V.
PEW 1623 PV ⊕	(+)	PEW 3223 PV ⊕	(+)				
PEW 1633 PV ⊕	A.V.	PEW 3233 PV	A.V.	PEW 6333 PV	A.V.	PEW 12533 PV	A.V.
PEW 1683 PV	A.V.	PEW 3283 PV	A.V.	PEW 6383 PV	A.V.	PEW 12583 PV	A.V.
PEW 1644 PV ⊕	Yellow	PEW 3244 PV ⊕	Yellow	PEW 6344 PV ⊕	Yellow	PEW 12544 PV ⊕	Yellow
PEW 1694 PV ⊕	Blue	PEW 3294 PV ⊕	Blue	PEW 6394 PV ⊕	Blue	PEW 12594 PV ⊕	Blue
PEW 1664 PV ⊕	Red	PEW 3264 PV ⊕	Red	PEW 6364 PV ⊕	Red	PEW 12564 PV ⊕	Red
PEW 16114 PV ⊕	Red	PEW 32114 PV ⊕	Red	PEW 63114 PV ⊕	Red	PEW 125114 PV ⊕	Red
PEW 1674 PV ⊕	Black	PEW 3274 PV ⊕	Black	PEW 6374 PV ⊕	Black	PEW 12574 PV ⊕	Black
PEW 1654 PV	Black	PEW 3254 PV	Black	PEW 6354 PV	Black	PEW 12554 PV	Black
PEW 1634 PV ⊕	Red	PEW 3234 PV ⊕	Red				
PEW 1634 PV ⊕	Red	PEW 3234 PV ⊕	Red				
PEW 16104 PV ⊕	(+)	PEW 32104 PV ⊕	(+)				
PEW 1624 PV ⊕	(+)	PEW 3224 PV ⊕	(+)				
PEW 1645 PV ⊕	Yellow	PEW 3245 PV ⊕	Yellow	PEW 6345 PV ⊕	Yellow	PEW 12545 PV ⊕	Yellow
PEW 1695 PV ⊕	Blue	PEW 3295 PV ⊕	Blue	PEW 6395 PV ⊕	Blue	PEW 12595 PV ⊕	Blue
PEW 1665 PV ⊕	Red	PEW 3265 PV ⊕	Red	PEW 6365 PV ⊕	Red	PEW 12565 PV ⊕	Red
PEW 1675 PV ⊕	Black	PEW 3275 PV ⊕	Black	PEW 6375 PV ⊕	Black	PEW 12575 PV ⊕	Black
PEW 1655 PV	Black	PEW 3255 PV	Black	PEW 6355 PV	Black	PEW 12555 PV	Black
PEW 16115 PV ⊕	Red	PEW 32115 PV ⊕	Red	PEW 63115 PV ⊕	Red	PEW 125115 PV ⊕	Red
PEW 1635 PV ⊕	Red	PEW 3235 PV ⊕	Red				
PEW 1635 PV ⊕	Red	PEW 3235 PV ⊕	Red				
PEW 1625 PV ⊕	(+)	PEW 3225 PV ⊕	(+)				

Dimensions in mm

(16 / 32A) PEW ... PV

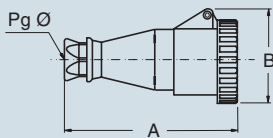

PEW...PV	A	B	Pg ø
16A 2P+⊕	153	77	16
3P+⊕	158	85	16
3P+N+⊕	166	93	21
32A 2P+⊕	183	98	21
3P+⊕	183	98	21
3P+N+⊕	188	105	21

Dimensions in mm

(63 / 125A) PEW ... PV

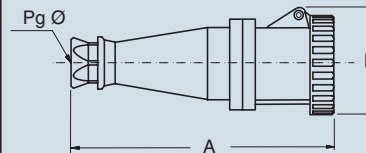

PEW...PV	A	B	Pg ø
63A 2P+⊕	277	108.5	36
3P+⊕	277	108.5	36
3P+N+⊕	277	108.5	36
125A 2P+⊕	324	120.5	2" gas
3P+⊕	324	120.5	2" gas
3P+N+⊕	324	120.5	2" gas

- Compliant with EN 60309-1 and -2
- Enclosure, insert and locking ring in insulating, thermoplastic, self-extinguishing material
- PE...SM types (IP44), enclosure colour coded according to operating voltage, top entry with threaded grommet (replaceable with cable gland)
- PEW...SM types (IP67), RAL 7035 grey enclosure, locking ring with gasket colour coded according to operating voltage, top entry with cable gland
- Terminals with retained screws
- 63A, 125A: with pilot contact
- Nickel-plated contacts, available on request for 16A and 32A (standard on 63A and 125A)**
- 125A: with terminal block for the anchoring of incoming cables, already connected to socket
- IP44 and IP67 degrees of protection (EN 60529)
- With Italian Quality Mark

16A
IP44 degree of protection



32A
IP44 degree of protection



Number of poles	Frequency Hz	Voltage V	Earthing contact position h	Part No.	Colour	Part No.	Colour	
2P+⊕	50 and 60	100 - 130	4	PE 1643 SM		PE 3243 SM		
	50 and 60	200 - 250	6	PE 1663 SM		PE 3263 SM		
	50 and 60	380 - 415	9	PE 1693 SM		PE 3293 SM		
	50 and 60	480 - 500	7	PE 1673 SM		PE 3273 SM		
	50 and 60	ins. transformer	12	PE 16123 SM	A.V.	PE 32123 SM	A.V.	
	> 300 - 500	> 50	2	PE 1623 SM		PE 3223 SM		
	d.c.	> 50 - 250	3	PE 1633 SM	A.V.	PE 3233 SM	A.V.	
	d.c.	> 250	8	PE 1683 SM	A.V.	PE 3283 SM	A.V.	
	3P+⊕	50 and 60	100 - 130	4	PE 1644 SM		PE 3244 SM	
50 and 60		200 - 250	9	PE 1694 SM		PE 3294 SM		
50 and 60		380 - 415	6	PE 1664 SM		PE 3264 SM		
60		440 - 460	11	PE 16114 SM		PE 32114 SM		
50 and 60		480 - 500	7	PE 1674 SM		PE 3274 SM		
50 and 60		600 - 690	5	PE 1654 SM		PE 3254 SM		
50		380	3	PE 1634 SM		PE 3234 SM		
60		440	3	PE 1634 SM		PE 3234 SM		
100 - 300		> 50	10	PE 16104 SM		PE 32104 SM		
> 300 - 500		> 50	2	PE 1624 SM		PE 3224 SM		
3P+N+⊕		50 and 60	57/100 - 75/130	4	PE 1645 SM		PE 3245 SM	
		50 and 60	120/208 - 144/250	9	PE 1695 SM		PE 3295 SM	
	50 and 60	200/346 - 240/415	6	PE 1665 SM		PE 3265 SM		
	50 and 60	277/480 - 288/500	7	PE 1675 SM		PE 3275 SM		
	50 and 60	347/600 - 400/690	5	PE 1655 SM		PE 3255 SM		
	60	250/440 - 265/460	11	PE 16115 SM		PE 32115 SM		
	50	220/380	3	PE 1635 SM		PE 3235 SM		
	60	250/440	3	PE 1635 SM		PE 3235 SM		
	> 300 - 500	> 50	2	PE 1625 SM		PE 3225 SM		

Legend

A.V. = Colour according to voltage

(*) Green may be used together with the colour of the operating range for frequencies above 60 Hz and up to a maximum of 500 Hz.

(**) For the code of products with nickel-plated contacts (socket holes, plug pins), add "N" to the pre-code of the corresponding standard product code; for example: PE becomes PEN and PEW becomes PEWN.

Accessories for IP67 plugs (optional)

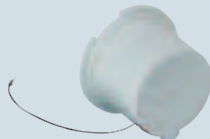

Loose protective cover

Size	Polarity	Part No.
16A	2P+⊕	PEW 163 CS
16A	3P+⊕	PEW 164 CS
16A	3P+N+⊕	PEW 165 CS
32A	2/3P+⊕	PEW 324 CS
32A	3P+N+⊕	PEW 325 CS
63A	All	PEW 63 CS
125A	All	PEW 125 CS

Dimensions indicated are not binding and may be changed without prior notice.

Dimensions in mm

(16 / 32A) PE ... SM

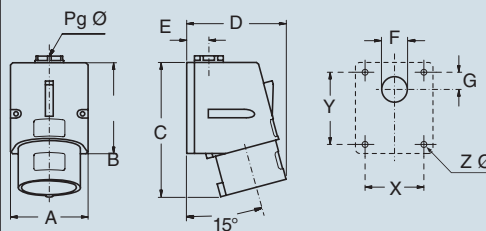

PE...SM	A	B	C	D	E	F	G	X	Y	Z	Pg Ø	
16A	2P+⊕	70	82	115	75	20	23	16	53	65	4.5	16
	3P+⊕	70	82	117	75	20	23	16	53	65	4.5	16
	3P+N+⊕	70	82	121	90	20	23	16	53	65	4.5	16
32A	2P+⊕	86	104	145	95	24	29	17	61	79	6.5	21
	3P+⊕	86	104	145	95	24	29	17	61	79	6.5	21
	3P+N+⊕	86	104	147	95	24	29	17	61	79	6.5	21

PEW...SM wall-mounting plugs, low voltage from over 50V up to 690V



16A
IP67 degree of protection



32A
IP67 degree of protection



63A
IP67 degree of protection



125A
IP67 degree of protection



Part No.	Colour	Part No.	Colour	Part No.	Colour	Part No.	Colour
PEW 1643 SM ⊕	Yellow	PEW 3243 SM ⊕	Yellow	PEW 6343 SM ⊕	Yellow	PEW 12543 SM ⊕	Yellow
PEW 1663 SM ⊕	Blue	PEW 3263 SM ⊕	Blue	PEW 6363 SM ⊕	Blue	PEW 12563 SM ⊕	Blue
PEW 1693 SM ⊕	Red	PEW 3293 SM ⊕	Red	PEW 6393 SM ⊕	Red	PEW 12593 SM ⊕	Red
PEW 1673 SM ⊕	Black	PEW 3273 SM ⊕	Black	PEW 6373 SM ⊕	Black	PEW 12573 SM ⊕	Black
PEW 16123 SM ⊕	A.V.	PEW 32123 SM ⊕	A.V.	PEW 63123 SM ⊕	A.V.	PEW 125123 SM ⊕	A.V.
PEW 1623 SM ⊕	(+)	PEW 3223 SM ⊕	(+)				
PEW 1633 SM ⊕	A.V.	PEW 3233 SM ⊕	A.V.	PEW 6333 SM	A.V.	PEW 12533 SM	A.V.
PEW 1683 SM	A.V.	PEW 3283 SM	A.V.	PEW 6383 SM	A.V.	PEW 12583 SM	A.V.
PEW 1644 SM ⊕	Yellow	PEW 3244 SM ⊕	Yellow	PEW 6344 SM ⊕	Yellow	PEW 12544 SM ⊕	Yellow
PEW 1694 SM ⊕	Blue	PEW 3294 SM ⊕	Blue	PEW 6394 SM ⊕	Blue	PEW 12594 SM ⊕	Blue
PEW 1664 SM ⊕	Red	PEW 3264 SM ⊕	Red	PEW 6364 SM ⊕	Red	PEW 12564 SM ⊕	Red
PEW 16114 SM ⊕	Red	PEW 32114 SM ⊕	Red	PEW 63114 SM ⊕	Red	PEW 125114 SM ⊕	Red
PEW 1674 SM ⊕	Black	PEW 3274 SM ⊕	Black	PEW 6374 SM ⊕	Black	PEW 12574 SM ⊕	Black
PEW 1654 SM	Black	PEW 3254 SM	Black	PEW 6354 SM	Black	PEW 12554 SM	Black
PEW 1634 SM ⊕	Red	PEW 3234 SM ⊕	Red				
PEW 1634 SM ⊕	Red	PEW 3234 SM ⊕	Red				
PEW 16104 SM ⊕	(+)	PEW 32104 SM ⊕	(+)				
PEW 1624 SM ⊕	(+)	PEW 3224 SM ⊕	(+)				
PEW 1645 SM ⊕	Yellow	PEW 3245 SM ⊕	Yellow	PEW 6345 SM ⊕	Yellow	PEW 12545 SM ⊕	Yellow
PEW 1695 SM ⊕	Blue	PEW 3295 SM ⊕	Blue	PEW 6395 SM ⊕	Blue	PEW 12595 SM ⊕	Blue
PEW 1665 SM ⊕	Red	PEW 3265 SM ⊕	Red	PEW 6365 SM ⊕	Red	PEW 12565 SM ⊕	Red
PEW 1675 SM ⊕	Black	PEW 3275 SM ⊕	Black	PEW 6375 SM ⊕	Black	PEW 12575 SM ⊕	Black
PEW 1655 SM	Black	PEW 3255 SM	Black	PEW 6355 SM	Black	PEW 12555 SM	Black
PEW 16115 SM ⊕	Red	PEW 32115 SM ⊕	Red	PEW 63115 SM ⊕	Red	PEW 125115 SM ⊕	Red
PEW 1635 SM ⊕	Red	PEW 3235 SM ⊕	Red				
PEW 1635 SM ⊕	Red	PEW 3235 SM ⊕	Red				
PEW 1625 SM ⊕	(+)	PEW 3225 SM ⊕	(+)				

Dimensions in mm

(16 / 32A) PEW ... SM

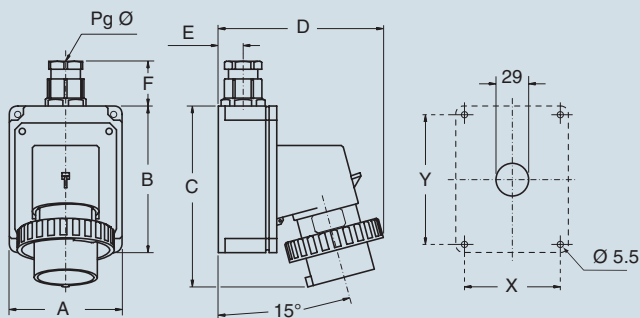

PEW...SM	A	B	C	D	E	F	X	Y	Pg ø	
16A	2P+⊕	75	115	144	126	19	35	65	105	16
	3P+⊕	75	115	144	134	19	35	65	105	16
	3P+N+⊕	100	130	164	145	22	42	85	115	21
32A	2P+⊕	100	130	178	154	22	42	85	115	21
	3P+⊕	100	130	178	154	22	42	85	115	21
	3P+N+⊕	100	130	178	160	22	42	85	115	21

Dimensions in mm

(63A) PEW ... SM

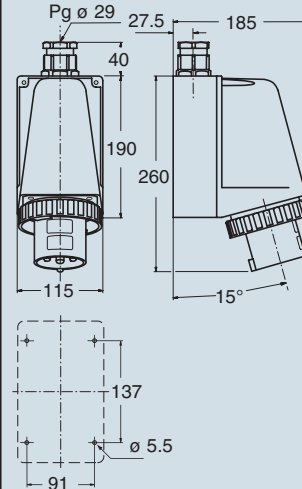

(125A) PEW ... SM

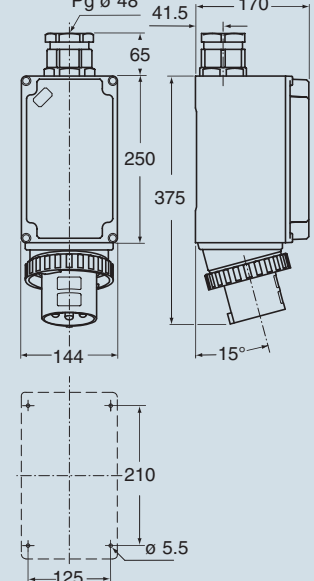

PEW...SM



- Compliant with EN 60309-1 and -2
- Enclosure, insert and locking ring in insulating, thermoplastic, self-extinguishing material
- Flange with anti-ageing gasket
- PE...SI types (IP44), RAL 7035 grey enclosure, plug mouth colour coded according to operating voltage
- PEW...SI (IP67) types, RAL 7035 grey enclosure, locking ring with gasket colour coded according to operating voltage
- Terminals with retained screws
- 63A, 125A: with pilot contact
- Nickel-plated contacts, available on request for 16A and 32A (standard on 63A and 125A)**
- IP44 and IP67 degrees of protection (EN 60529)
- With Italian Quality Mark

16A
IP44 degree of protection



32A
IP44 degree of protection



Number of poles	Frequency Hz	Voltage V	Earthing contact position h	Part No.	Colour	Part No.	Colour	
2P+⊕	50 and 60	100 - 130	4	PE 1643 SI		PE 3243 SI		
	50 and 60	200 - 250	6	PE 1663 SI		PE 3263 SI		
	50 and 60	380 - 415	9	PE 1693 SI		PE 3293 SI		
	50 and 60	480 - 500	7	PE 1673 SI		PE 3273 SI		
	50 and 60	ins. transformer	12	PE 16123 SI	A.V.	PE 32123 SI	A.V.	
	> 300 - 500	> 50	2	PE 1623 SI		PE 3223 SI		
	d.c.	> 50 - 250	3	PE 1633 SI	A.V.	PE 3233 SI	A.V.	
	d.c.	> 250	8	PE 1683 SI	A.V.	PE 3283 SI	A.V.	
	3P+⊕	50 and 60	100 - 130	4	PE 1644 SI		PE 3244 SI	
		50 and 60	200 - 250	9	PE 1694 SI		PE 3294 SI	
50 and 60		380 - 415	6	PE 1664 SI		PE 3264 SI		
60		440 - 460	11	PE 16114 SI		PE 32114 SI		
50 and 60		480 - 500	7	PE 1674 SI		PE 3274 SI		
50 and 60		600 - 690	5	PE 1654 SI		PE 3254 SI		
50		380	3	PE 1634 SI		PE 3234 SI		
60		440	3	PE 1634 SI		PE 3234 SI		
100 - 300		> 50	10	PE 16104 SI		PE 32104 SI		
> 300 - 500		> 50	2	PE 1624 SI		PE 3224 SI		
3P+N+⊕	50 and 60	57/100 - 75/130	4	PE 1645 SI		PE 3245 SI		
	50 and 60	120/208 - 144/250	9	PE 1695 SI		PE 3295 SI		
	50 and 60	200/346 - 240/415	6	PE 1665 SI		PE 3265 SI		
	50 and 60	277/480 - 288/500	7	PE 1675 SI		PE 3275 SI		
	50 and 60	347/600 - 400/690	5	PE 1655 SI		PE 3255 SI		
	60	250/440 - 265/460	11	PE 16115 SI		PE 32115 SI		
	50	220/380	3	PE 1635 SI		PE 3235 SI		
	60	250/440	3	PE 1635 SI		PE 3235 SI		
	> 300 - 500	> 50	2	PE 1625 SI		PE 3225 SI		

Legend

A.V. = Colour according to voltage

(*) Green may be used together with the colour of the operating range for frequencies above 60 Hz and up to a maximum of 500 Hz.

(**) For the code of products with nickel-plated contacts (socket holes, plug pins), add "N" to the pre-code of the corresponding standard product code; for example: PE becomes PEN and PEW becomes PEWN.

Accessories for IP67 plugs (optional)



Loose protective cover

Size	Polarity	Part No.
16A	2P+⊕	PEW 163 CS
16A	3P+⊕	PEW 164 CS
16A	3P+N+⊕	PEW 165 CS
32A	2/3P+⊕	PEW 324 CS
32A	3P+N+⊕	PEW 325 CS
63A	All	PEW 63 CS
125A	All	PEW 125 CS

Dimensions indicated are not binding and may be changed without prior notice.

Dimensions in mm

(16 / 32A) PE ... SI

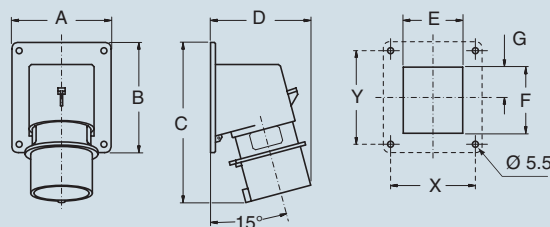

PE...SI	A	B	C	D	E	F	G	X	Y	
16A	2P+⊕	65	82	126	81	41	43	21.5	52	60
	3P+⊕	65	82	126	81	47	43	21.5	52	60
	3P+N+⊕	90	100	146	93	54	60	27.5	77	85
32A	2P+⊕	90	100	160	101	55	60	27.5	77	85
	3P+⊕	90	100	160	101	55	60	27.5	77	85
	3P+N+⊕	90	100	160	106	62	60	27.5	77	85

PEW flush-mounting plugs, low voltage from over 50V up to 690V



16A
IP67 degree of protection



32A
IP67 degree of protection



63A
IP67 degree of protection



125A
IP67 degree of protection



Part No.	Colour	Part No.	Colour	Part No.	Colour	Part No.	Colour
PEW 1643 SI ⊕	Yellow	PEW 3243 SI ⊕	Yellow	PEW 6343 SI ⊕	Yellow	PEW 12543 SI ⊕	Yellow
PEW 1663 SI ⊕	Blue	PEW 3263 SI ⊕	Blue	PEW 6363 SI ⊕	Blue	PEW 12563 SI ⊕	Blue
PEW 1693 SI ⊕	Red	PEW 3293 SI ⊕	Red	PEW 6393 SI ⊕	Red	PEW 12593 SI ⊕	Red
PEW 1673 SI ⊕	Black	PEW 3273 SI ⊕	Black	PEW 6373 SI ⊕	Black	PEW 12573 SI ⊕	Black
PEW 16123 SI ⊕	A.V.	PEW 32123 SI ⊕	A.V.	PEW 63123 SI ⊕	A.V.	PEW 125123 SI ⊕	A.V.
PEW 1623 SI ⊕	(+)	PEW 3223 SI ⊕	(+)				
PEW 1633 SI ⊕	A.V.	PEW 3233 SI	A.V.	PEW 6333 SI	A.V.	PEW 12533 SI	A.V.
PEW 1683 SI	A.V.	PEW 3283 SI	A.V.	PEW 6383 SI	A.V.	PEW 12583 SI	A.V.
PEW 1644 SI ⊕	Yellow	PEW 3244 SI ⊕	Yellow	PEW 6344 SI ⊕	Yellow	PEW 12544 SI ⊕	Yellow
PEW 1694 SI ⊕	Blue	PEW 3294 SI ⊕	Blue	PEW 6394 SI ⊕	Blue	PEW 12594 SI ⊕	Blue
PEW 1664 SI ⊕	Red	PEW 3264 SI ⊕	Red	PEW 6364 SI ⊕	Red	PEW 12564 SI ⊕	Red
PEW 16114 SI ⊕	Red	PEW 32114 SI ⊕	Red	PEW 63114 SI ⊕	Red	PEW 125114 SI ⊕	Red
PEW 1674 SI ⊕	Black	PEW 3274 SI ⊕	Black	PEW 6374 SI ⊕	Black	PEW 12574 SI ⊕	Black
PEW 1654 SI	Black	PEW 3254 SI	Black	PEW 6354 SI	Black	PEW 12554 SI	Black
PEW 1634 SI ⊕	Red	PEW 3234 SI ⊕	Red				
PEW 1634 SI ⊕	Red	PEW 3234 SI ⊕	Red				
PEW 16104 SI ⊕	(+)	PEW 32104 SI ⊕	(+)				
PEW 1624 SI ⊕	(+)	PEW 3224 SI ⊕	(+)				
PEW 1645 SI ⊕	Yellow	PEW 3245 SI ⊕	Yellow	PEW 6345 SI ⊕	Yellow	PEW 12545 SI ⊕	Yellow
PEW 1695 SI ⊕	Blue	PEW 3295 SI ⊕	Blue	PEW 6395 SI ⊕	Blue	PEW 12595 SI ⊕	Blue
PEW 1665 SI ⊕	Red	PEW 3265 SI ⊕	Red	PEW 6365 SI ⊕	Red	PEW 12565 SI ⊕	Red
PEW 1675 SI ⊕	Black	PEW 3275 SI ⊕	Black	PEW 6375 SI ⊕	Black	PEW 12575 SI ⊕	Black
PEW 1655 SI	Black	PEW 3255 SI	Black	PEW 6355 SI	Black	PEW 12555 SI	Black
PEW 16115 SI ⊕	Red	PEW 32115 SI ⊕	Red	PEW 63115 SI ⊕	Red	PEW 125115 SI ⊕	Red
PEW 1635 SI ⊕	Red	PEW 3235 SI ⊕	Red				
PEW 1635 SI ⊕	Red	PEW 3235 SI ⊕	Red				
PEW 1625 SI ⊕	(+)	PEW 3225 SI ⊕	(+)				

Dimensions in mm

(16 / 32A) PEW ... SI

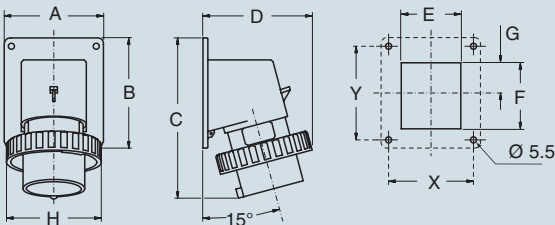

PEW...SI	A	B	C	D	E	F	G	H	X	Y
16A 2P+⊕	65	82	126	81	41	43	21.5	70	52	60
3P+⊕	65	82	126	81	47	43	24.5	78	52	60
3P+N+⊕	90	100	146	93	54	60	27.5	86	77	85
32A 2P+⊕	90	100	160	101	55	60	27.5	92	77	85
3P+⊕	90	100	160	101	55	60	27.5	92	77	85
3P+N+⊕	90	100	160	101	62	60	27.5	100	77	85

Dimensions in mm

(63A) PEW ... SI

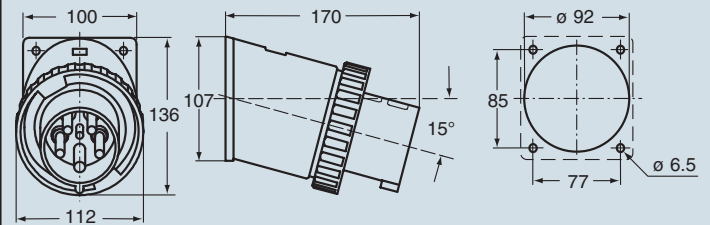

(125A) PEW ... SI

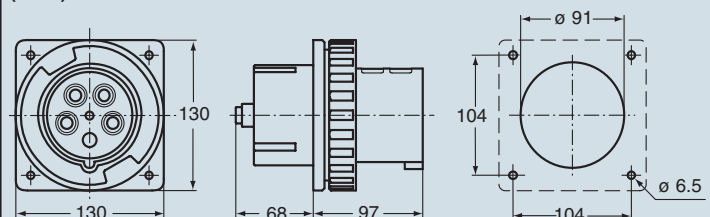

PEW.SI

- Compliant with EN 60309-1 and -2
- Enclosure, insert and locking ring in insulating, thermoplastic, self-extinguishing material
- Cable anchoring collar incorporated in the insert
- PE...SV types (IP44), entry with grommet, enclosure colour coded according to operating voltage
- PEW...SV types (IP67), cable entry with grommet, RAL 7035 grey enclosure, locking ring with gasket colour coded according to operating voltage
- Terminals with retained screws
- 63A, 125A: with pilot contact
- Nickel-plated contacts, available on request for 16A and 32A (standard on 63A and 125A)**
- IP44 and IP67 degrees of protection (EN 60529)
- With Italian Quality Mark

16A
IP44 degree of protection



32A
IP44 degree of protection



Number of poles	Frequency Hz	Voltage V	Earthing contact position h	Part No.	Colour	Part No.	Colour	
2P+⊕	50 and 60	100 - 130	4	PE 1643 SV		PE 3243 SV		
	50 and 60	200 - 250	6	PE 1663 SV		PE 3263 SV		
	50 and 60	380 - 415	9	PE 1693 SV		PE 3293 SV		
	50 and 60	480 - 500	7	PE 1673 SV		PE 3273 SV		
	50 and 60	ins. transformer	12	PE 16123 SV	A.V.	PE 32123 SV	A.V.	
	> 300 - 500	> 50	2	PE 1623 SV		PE 3223 SV		
	d.c.	> 50 - 250	3	PE 1633 SV	A.V.	PE 3233 SV	A.V.	
	d.c.	> 250	8	PE 1683 SV	A.V.	PE 3283 SV	A.V.	
	3P+⊕	50 and 60	100 - 130	4	PE 1644 SV		PE 3244 SV	
		50 and 60	200 - 250	9	PE 1694 SV		PE 3294 SV	
50 and 60		380 - 415	6	PE 1664 SV		PE 3264 SV		
60		440 - 460	11	PE 16114 SV		PE 32114 SV		
50 and 60		480 - 500	7	PE 1674 SV		PE 3274 SV		
50 and 60		600 - 690	5	PE 1654 SV		PE 3254 SV		
50		380	3	PE 1634 SV		PE 3234 SV		
60		440	3	PE 1634 SV		PE 3234 SV		
100 - 300		> 50	10	PE 16104 SV		PE 32104 SV		
> 300 - 500		> 50	2	PE 1624 SV		PE 3224 SV		
3P+N+⊕	50 and 60	57/100 - 75/130	4	PE 1645 SV		PE 3245 SV		
	50 and 60	120/208 - 144/250	9	PE 1695 SV		PE 3295 SV		
	50 and 60	200/346 - 240/415	6	PE 1665 SV		PE 3265 SV		
	50 and 60	277/480 - 288/500	7	PE 1675 SV		PE 3275 SV		
	50 and 60	347/600 - 400/690	5	PE 1655 SV		PE 3255 SV		
	60	250/440 - 265/460	11	PE 16115 SV		PE 32115 SV		
	50	220/380	3	PE 1635 SV		PE 3235 SV		
	60	250/440	3	PE 1635 SV		PE 3235 SV		
	> 300 - 500	> 50	2	PE 1625 SV		PE 3225 SV		

Legend

A.V. = Colour according to voltage

(*) Green may be used together with the colour of the operating range for frequencies above 60 Hz and up to a maximum of 500 Hz.

(**) For the code of products with nickel-plated contacts (socket holes, plug pins), add "N" to the pre-code of the corresponding standard product code; for example: PE becomes PEN and PEW becomes PEWN.

Accessories for IP67 plugs (optional)

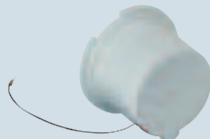

Loose protective cover

Size	Polarity	Part No.
16A	2P+⊕	PEW 163 CS
16A	3P+⊕	PEW 164 CS
16A	3P+N+⊕	PEW 165 CS
32A	2/3P+⊕	PEW 324 CS
32A	3P+N+⊕	PEW 325 CS
63A	All	PEW 63 CS
125A	All	PEW 125 CS

Dimensions indicated are not binding and may be changed without prior notice.

Dimensions in mm

(16 / 32A) PE ... SV

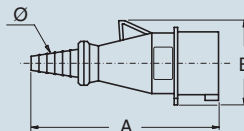

PE...SV	A	B	ø min	ø max	
16A	2P+⊕	143.5	59	7	17
	3P+⊕	148.5	66	7	17
	3P+N+⊕	167.5	75	9	22
32A	2P+⊕	187	80	9	22
	3P+⊕	187	80	9	22
	3P+N+⊕	192.5	87	9	22

PEW...SV coupler plugs, low voltage from over 50V up to 690V



16A
IP67 degree of protection



32A
IP67 degree of protection



63A
IP67 degree of protection



125A
IP67 degree of protection



Part No.	Colour	Part No.	Colour	Part No.	Colour	Part No.	Colour
PEW 1643 SV ⊕	Yellow	PEW 3243 SV ⊕	Yellow	PEW 6343 SV ⊕	Yellow	PEW 12543 SV ⊕	Yellow
PEW 1663 SV ⊕	Blue	PEW 3263 SV ⊕	Blue	PEW 6363 SV ⊕	Blue	PEW 12563 SV ⊕	Blue
PEW 1693 SV ⊕	Red	PEW 3293 SV ⊕	Red	PEW 6393 SV ⊕	Red	PEW 12593 SV ⊕	Red
PEW 1673 SV ⊕	Black	PEW 3273 SV ⊕	Black	PEW 6373 SV ⊕	Black	PEW 12573 SV ⊕	Black
PEW 16123 SV ⊕	A.V.	PEW 32123 SV ⊕	A.V.	PEW 63123 SV ⊕	A.V.	PEW 125123 SV ⊕	A.V.
PEW 1623 SV ⊕	(+)	PEW 3223 SV ⊕	(+)				
PEW 1633 SV ⊕	A.V.	PEW 3233 SV	A.V.	PEW 6333 SV	A.V.	PEW 12533 SV	A.V.
PEW 1683 SV	A.V.	PEW 3283 SV	A.V.	PEW 6383 SV	A.V.	PEW 12583 SV	A.V.
PEW 1644 SV ⊕	Yellow	PEW 3244 SV ⊕	Yellow	PEW 6344 SV ⊕	Yellow	PEW 12544 SV ⊕	Yellow
PEW 1694 SV ⊕	Blue	PEW 3294 SV ⊕	Blue	PEW 6394 SV ⊕	Blue	PEW 12594 SV ⊕	Blue
PEW 1664 SV ⊕	Red	PEW 3264 SV ⊕	Red	PEW 6364 SV ⊕	Red	PEW 12564 SV ⊕	Red
PEW 16114 SV ⊕	Red	PEW 32114 SV ⊕	Red	PEW 63114 SV ⊕	Red	PEW 125114 SV ⊕	Red
PEW 1674 SV ⊕	Black	PEW 3274 SV ⊕	Black	PEW 6374 SV ⊕	Black	PEW 12574 SV ⊕	Black
PEW 1654 SV	Black	PEW 3254 SV	Black	PEW 6354 SV	Black	PEW 12554 SV	Black
PEW 1634 SV ⊕	Red	PEW 3234 SV ⊕	Red				
PEW 1634 SV ⊕	Red	PEW 3234 SV ⊕	Red				
PEW 16104 SV ⊕	(+)	PEW 32104 SV ⊕	(+)				
PEW 1624 SV ⊕	(+)	PEW 3224 SV ⊕	(+)				
PEW 1645 SV ⊕	Yellow	PEW 3245 SV ⊕	Yellow	PEW 6345 SV ⊕	Yellow	PEW 12545 SV ⊕	Yellow
PEW 1695 SV ⊕	Blue	PEW 3295 SV ⊕	Blue	PEW 6395 SV ⊕	Blue	PEW 12595 SV ⊕	Blue
PEW 1665 SV ⊕	Red	PEW 3265 SV ⊕	Red	PEW 6365 SV ⊕	Red	PEW 12565 SV ⊕	Red
PEW 1675 SV ⊕	Black	PEW 3275 SV ⊕	Black	PEW 6375 SV ⊕	Black	PEW 12575 SV ⊕	Black
PEW 1655 SV	Black	PEW 3255 SV	Black	PEW 6355 SV	Black	PEW 12555 SV	Black
PEW 16115 SV ⊕	Red	PEW 32115 SV ⊕	Red	PEW 63115 SV ⊕	Red	PEW 125115 SV ⊕	Red
PEW 1635 SV ⊕	Red	PEW 3235 SV ⊕	Red				
PEW 1635 SV ⊕	Red	PEW 3235 SV ⊕	Red				
PEW 1625 SV ⊕	(+)	PEW 3225 SV ⊕	(+)				

Dimensions in mm

(16 / 32A) PEW ... SV

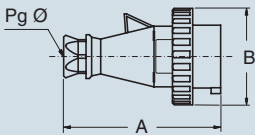

PEW...SV	A	B	Pg ø
16A 2P+⊕	137	70	16
3P+⊕	142	78	16
3P+N+⊕	150	86	21
32A 2P+⊕	170	92	21
3P+⊕	170	92	21
3P+N+⊕	175	99.5	21

Dimensions in mm

(63 / 125A) PEW ... SV

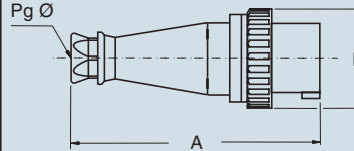

PEW...SV	A	B	Pg ø
63A 2P+⊕	264.5	112	36
3P+⊕	264.5	112	36
3P+N+⊕	264.5	112	36
125A 2P+⊕	310	130	2" gas
3P+⊕	310	130	2" gas
3P+N+⊕	310	130	2" gas

PEW...SV

- Compliant with EN 60309-1 and -2
- Enclosure, insert and locking ring in insulating, thermoplastic, self-extinguishing material
- Cable anchoring collar incorporated in the insert
- Entry with cable gland
- PE...SA types (IP44), enclosure colour coded according to operating voltage
- PEW...SA types (IP67), RAL 7035 grey enclosure, locking ring with gasket colour coded according to operating voltage
- Terminals with retained screws
- Nickel-plated contacts, available on request for 16A and 32A**
- IP44 and IP67 degrees of protection (EN 60529)
- With Italian Quality Mark

16A
IP44 degree of protection



32A
IP44 degree of protection



Number of poles	Frequency Hz	Voltage V	Earthing contact position h	Part No.	Colour	Part No.	Colour
2P+⊕	50 and 60	100 - 130	4	PE 1643 SA		PE 3243 SA	
	50 and 60	200 - 250	6	PE 1663 SA		PE 3263 SA	
	50 and 60	380 - 415	9	PE 1693 SA		PE 3293 SA	
	50 and 60	480 - 500	7	PE 1673 SA		PE 3273 SA	
	50 and 60	ins. transformer	12	PE 16123 SA	A.V.	PE 32123 SA	A.V.
	> 300 - 500	> 50	2	PE 1623 SA		PE 3223 SA	
	d.c.	> 50 - 250	3	PE 1633 SA	A.V.	PE 3233 SA	A.V.
	d.c.	> 250	8	PE 1683 SA	A.V.	PE 3283 SA	A.V.
	3P+⊕	50 and 60	100 - 130	4	PE 1644 SA		PE 3244 SA
50 and 60		200 - 250	9	PE 1694 SA		PE 3294 SA	
50 and 60		380 - 415	6	PE 1664 SA		PE 3264 SA	
60		440 - 460	11	PE 16114 SA		PE 32114 SA	
50 and 60		480 - 500	7	PE 1674 SA		PE 3274 SA	
50 and 60		600 - 690	5	PE 1654 SA		PE 3254 SA	
50		380	3	PE 1634 SA		PE 3234 SA	
60		440	3	PE 1634 SA		PE 3234 SA	
100 - 300		> 50	10	PE 16104 SA		PE 32104 SA	
> 300 - 500		> 50	2	PE 1624 SA		PE 3224 SA	
3P+N+⊕		50 and 60	57/100 - 75/130	4	PE 1645 SA		PE 3245 SA
	50 and 60	120/208 - 144/250	9	PE 1695 SA		PE 3295 SA	
	50 and 60	200/346 - 240/415	6	PE 1665 SA		PE 3265 SA	
	50 and 60	277/480 - 288/500	7	PE 1675 SA		PE 3275 SA	
	50 and 60	347/600 - 400/690	5	PE 1655 SA		PE 3255 SA	
	60	250/440 - 265/460	11	PE 16115 SA		PE 32115 SA	
	50	220/380	3	PE 1635 SA		PE 3235 SA	
	60	250/440	3	PE 1635 SA		PE 3235 SA	
	> 300 - 500	> 50	2	PE 1625 SA		PE 3225 SA	

Legend

A.V. = Colour according to voltage

(*) Green may be used together with the colour of the operating range for frequencies above 60 Hz and up to a maximum of 500 Hz.

(**) For the code of products with nickel-plated contacts (socket holes, plug pins), add "N" to the pre-code of the corresponding standard product code; for example: PE becomes PEN and PEW becomes PEWN.

Accessories for IP67 plugs (optional)

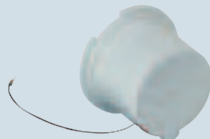

Loose protective cover

Size	Polarity	Part No.
16A	2P+⊕	PEW 163 CS
16A	3P+⊕	PEW 164 CS
16A	3P+N+⊕	PEW 165 CS
32A	2/3P+⊕	PEW 324 CS
32A	3P+N+⊕	PEW 325 CS

Dimensions indicated are not binding and may be changed without prior notice.

Dimensions in mm

(16 / 32A) PE ... SA

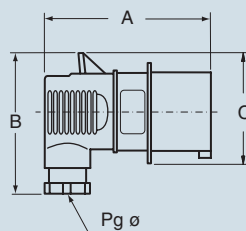

PE...SA	A	B	C	Pg ø
16A	2P+⊕	100	77	59
	3P+⊕	100	84	68
	3P+N+⊕	106	91	77
32A	2P+⊕	131	100	82
	3P+⊕	131	100	82
	3P+N+⊕	131	107	93

16A
IP67 degree of protection

32A
IP67 degree of protection



Part No.	Colour	Part No.	Colour
PEW 1643 SA ⊕	Yellow	PEW 3243 SA ⊕	Yellow
PEW 1663 SA ⊕	Blue	PEW 3263 SA ⊕	Blue
PEW 1693 SA ⊕	Red	PEW 3293 SA ⊕	Red
PEW 1673 SA ⊕	Black	PEW 3273 SA ⊕	Black
PEW 16123 SA ⊕	A.V.	PEW 32123 SA ⊕	A.V.
PEW 1623 SA ⊕	(+)	PEW 3223 SA ⊕	(+)
PEW 1633 SA ⊕	A.V.	PEW 3233 SA	A.V.
PEW 1683 SA	A.V.	PEW 3283 SA	A.V.
PEW 1644 SA ⊕	Yellow	PEW 3244 SA ⊕	Yellow
PEW 1694 SA ⊕	Blue	PEW 3294 SA ⊕	Blue
PEW 1664 SA ⊕	Red	PEW 3264 SA ⊕	Red
PEW 16114 SA ⊕	Red	PEW 32114 SA ⊕	Red
PEW 1674 SA ⊕	Black	PEW 3274 SA ⊕	Black
PEW 1654 SA	Black	PEW 3254 SA	Black
PEW 1634 SA ⊕	Red	PEW 3234 SA ⊕	Red
PEW 1634 SA ⊕	Red	PEW 3234 SA ⊕	Red
PEW 16104 SA ⊕	(+)	PEW 32104 SA ⊕	(+)
PEW 1624 SA ⊕	(+)	PEW 3224 SA ⊕	(+)
PEW 1645 SA ⊕	Yellow	PEW 3245 SA ⊕	Yellow
PEW 1695 SA ⊕	Blue	PEW 3295 SA ⊕	Blue
PEW 1665 SA ⊕	Red	PEW 3265 SA ⊕	Red
PEW 1675 SA ⊕	Black	PEW 3275 SA ⊕	Black
PEW 1655 SA	Black	PEW 3255 SA	Black
PEW 16115 SA ⊕	Red	PEW 32115 SA ⊕	Red
PEW 1635 SA ⊕	Red	PEW 3235 SA ⊕	Red
PEW 1635 SA ⊕	Red	PEW 3235 SA ⊕	Red
PEW 1625 SA ⊕	(+)	PEW 3225 SA ⊕	(+)

Dimensions in mm

(16 / 32A) PEW ...SA

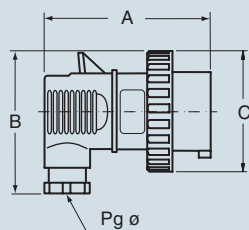

PEW...SA	A	B	C	Pg ø
16A 2P+⊕	100	77	59	13.5
3P+⊕	100	84	68	16
3P+N+⊕	106	91	77	16
32A 2P+⊕	131	100	82	21
3P+⊕	131	100	82	21
3P+N+⊕	131	107	93	21

- Compliant with EN 60309-1 and -2
- Enclosure and insert in insulating, thermoplastic and self-extinguishing material
- RAL 7035 grey enclosure, red spring lid (colour coded according to operating voltage)
- Elongated grounding contact to ensure maximum protection (if the electric wire is stretched, the grounding wire will be the last to detach)
- Contact terminals oriented in the same direction to facilitate automated wiring
- Cable anchorage with retained screws
- Nickel-plated contacts on request
- IP44 class of protection (EN 60529)
- With Italian Quality Mark

16A - 32A wall-mounting socket IP44 degree of protection



16A - 32A flush-mounting socket IP44 degree of protection



Number of poles	Frequency Hz	Voltage V	Rated current	Earthing cont. position h	Part No.	Colour	Part No.	Colour
3P+N+	50 and 60	200/346 - 240/415	16A	6	PEM 1665 PP		PEM 1665 PI	
	50 and 60	200/346 - 240/415	32A	6	PEM 3265 PP		PEM 3265 PI	

Version

In PEM plugs and socket-outlets, the contact holding insert (main part) is incorporated in the front of the enclosure. In these versions, the screws of the 5 terminals are oriented in the same direction in order to simplify automated wiring. The grounding pin is longer at the rear to provide greater safety if the cable anchor breaks. As the wires in the multiple cable are generally cut at the same length, the longer grounding terminal ensures that the last wire to be detached from the terminal is the protective one (PE) if the cable anchor breaks.

Dimensions in mm

PEM ... PP

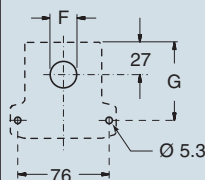
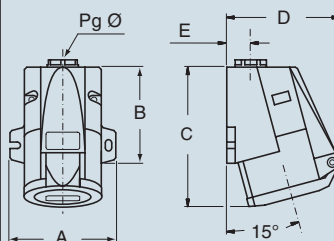

Type	A	B	C	D	E	F	G	Pg ø
16A	88	80	115	95	20	23	65	16
32A	95	105	145	110	24	29	85	21

Dimensions in mm

PEM ... PI

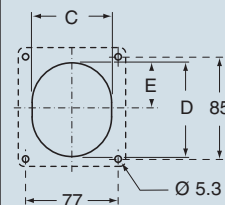
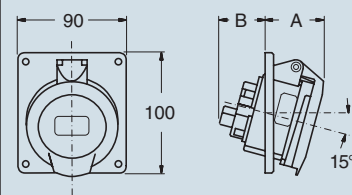

Type	A	B	C	D	E
16A	48	38	66	78	38
32A	50	52	74	86	40

Dimensions indicated are not binding and may be changed without prior notice.

PEM...

16A and 32A coupler socket-outlet
IP44 degree of protection

16A and 32A plugs
IP44 degree of protection

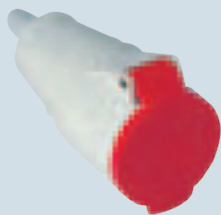

Part No.	Colour
PEM 1665 PV [®]	
PEM 3265 PV [®]	

Part No.	Colour
PEM 1665 SV [®]	
PEM 3265 SV [®]	

Dimensions in mm

Dimensions in mm

PEM ... PV

PEM ... SV

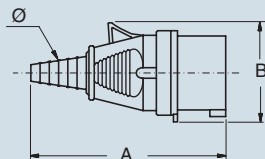
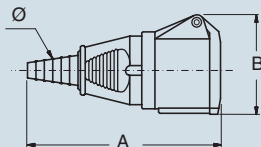

Type	A	B	ø min	ø max
16A	158	83	9	22
32A	180	90	9	22

Type	A	B	ø min	ø max
16A	145	75	9	22
32A	170	87	9	22

- Compliant with EN 60309-1 and -2
- Enclosure and insert in insulating, thermoplastic and self-extinguishing material
- SIP... types (IP44), red enclosure (colour coded according to operating voltage)
SIPW...types RAL 7035 grey enclosure, red bayonet ring (colour coded according to operating voltage)
- Built-in phase inverter device, operated by means of a screwdriver
- SIP... types (IP44), entry with threaded grommet,
SIPW...types (IP67), entry with cable gland,
- Terminals with retained screws
- Nickel-plated contacts on request
- IP44 and IP67 degrees of protection (EN 60529)

16A and 32A wall-mounting plugs IP44 degree of protection



16A and 32A wall-mounting plugs IP67 degree of protection



Number of poles	Frequency Hz	Voltage V	Rated current	Earthing cont. position h	Part No.	Colour	Part No.	Colour
3P+N+⊕	50 and 60	200/346 - 240/415	16A	6	SIP 1665 SM		SIPW 1665 SM	
	50 and 60	200/346 - 240/415	32A	6	SIP 3265 SM		SIPW 3265 SM	

Version

SIP plugs incorporate a mechanical device that exchanges the position of the pins of phases L2 and L3 (phase inverter); this enables the phase cycles to be adapted to the required direction of rotation of three-phase motors. The device can be regulated on the contact side using a screwdriver without having to disassemble the plug.



Accessories for IP67 plugs (optional)

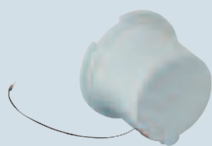

Loose protective cover

Size	Part No.
16A	PEW 165 CS
32A	PEW 325 CS

Dimensions indicated are not binding and may be changed without prior notice.

Dimensions in mm

SIP ... SM

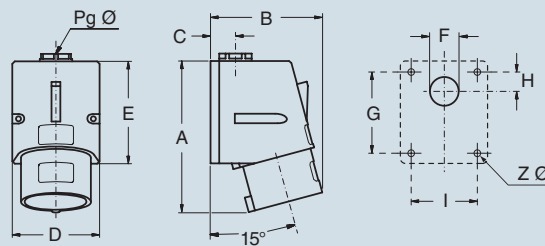

Type	A	B	C	D	E	F	G	H	I	Z	Pg	Ø
16A	121	90	20	70	82	23	65	16	53	4.3	16	
32A	147	95	24	86	104	29	79	17	61	6.3	21	

SIPW ... SM

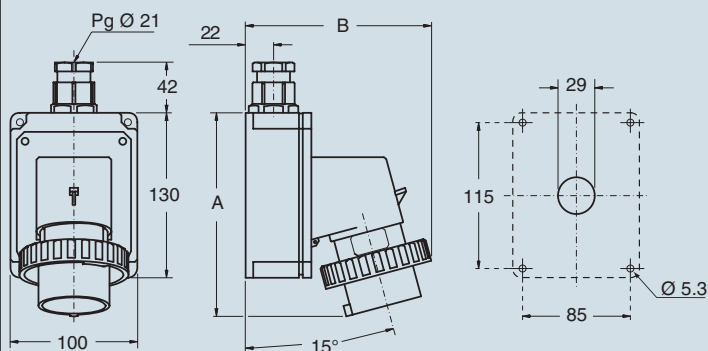

Type	A	B
16A	164	145
32A	178	160

16A and 32A flush-mounting plugs
IP44 degree of protection



16A and 32A flush-mounting plugs
IP67 degree of protection



16A and 32A plugs
IP44 degree of protection



16A and 32A plugs
IP67 degree of protection



Part No.	Colour	Part No.	Colour	Part No.	Colour	Part No.	Colour
SIP 1665 SI		SIPW 1665 SI		SIP 1665 SV		SIPW 1665 SV	
SIP 3265 SI		SIPW 3265 SI		SIP 3265 SV		SIPW 3265 SV	

Dimensions in mm

SIP ... SI

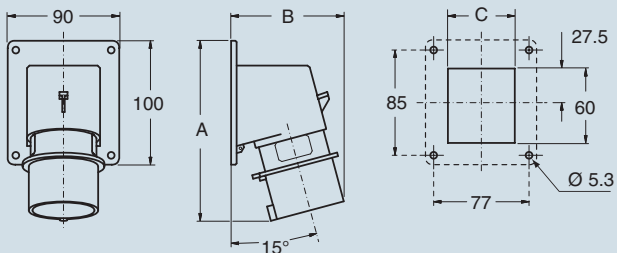

Type	A	B	C
16A	146	93	54
32A	160	106	62

SIPW ... SI

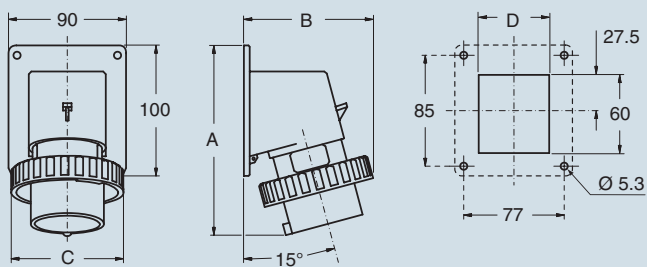

Type	A	B	C	D
16A	146	99	86	54
32A	160	113	100	62

Dimensions in mm

SIP ... SV

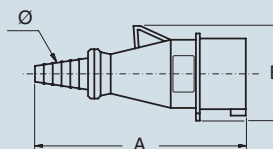

Type	A	B	ø min	ø max
16A	167.5	75	9	22
32A	192.5	87	9	22

SIPW ... SV

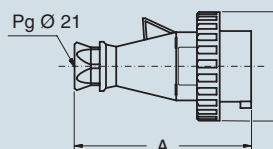

Type	A	B
16A	150	86
32A	175	99.5

SIP...

- Compliant with EN 60309-1 and -2
- Enclosure, insert and spring lid in insulating, thermoplastic, self-extinguishing material
- RAL 7035 grey enclosure
- Spring lid colour coded according to operating voltage and frequency
- Wall-mounting types PB...PP, top entry with threaded grommet (replaceable with cable gland)
- Flush-mounting types PB...PI, flange with anti-aging gasket
- Coupler types PB...PV, cable anchoring collar incorporated in the insert, entry with grommet
- Terminals with retained screws
- Nickel-plated contacts on request
- IP44 degree of protection (EN 60529)
- With Italian Quality Mark

16A wall-mounting socket
IP44 degree of protection



32A wall-mounting socket
IP44 degree of protection



Number of poles	Frequency Hz	Voltage V	Earthing contact position h	Part No.	Colour	Part No.	Colour
2P	50 and 60	20 - 25	-	PB 16002 PP		PB 32002 PP	
	50 and 60	40 - 50	12	PB 16122 PP		PB 32122 PP	
	> 100 - 200 included	20 - 25 and 40 - 50	4	PB 16042 PP		PB 32042 PP	
	300	20 - 25 and 40 - 50	2	PB 16022 PP		PB 32022 PP	
	400	20 - 25 and 40 - 50	3	PB 16032 PP		PB 32032 PP	
	> 400 - 500 included	20 - 25 and 40 - 50	11	PB 16112 PP		PB 32112 PP	
	DC	20 - 25 and 40 - 50	10	PB 16102 PP		PB 32102 PP	
3P	50 and 60	20 - 25	-	PB 16003 PP		PB 32003 PP	
	50 and 60	40 - 50	12	PB 16123 PP		PB 32123 PP	
	> 100 - 200 included	20 - 25 and 40 - 50	4	PB 16043 PP		PB 32043 PP	
	300	20 - 25 and 40 - 50	2	PB 16023 PP		PB 32023 PP	
	400	20 - 25 and 40 - 50	3	PB 16033 PP		PB 32033 PP	
	> 400 - 500 included	20 - 25 and 40 - 50	11	PB 16113 PP		PB 32113 PP	

(*) Green may be used together with the colour of the operating range for frequencies above 60 Hz and up to a maximum of 500 Hz.

Dimensions in mm

(16 / 32A) PB ... PP

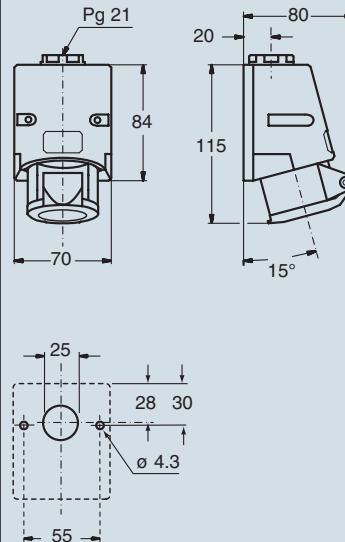

Dimensions indicated are not binding and may be changed without prior notice.

16A flush-mounting socket-outlets
IP44 degree of protection

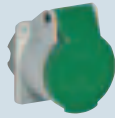

32A flush-mounting socket-outlets
IP44 degree of protection



16A couplers
IP44 degree of protection



32A couplers
IP44 degree of protection



Part No.	Colour	Part No.	Colour	Part No.	Colour	Part No.	Colour
PB 16002 PI ☼		PB 32002 PI ☼		PB 16002 PV ☼		PB 32002 PV ☼	
PB 16122 PI ☼		PB 32122 PI ☼		PB 16122 PV ☼		PB 32122 PV ☼	
PB 16042 PI ☼		PB 32042 PI ☼		PB 16042 PV ☼		PB 32042 PV ☼	
PB 16022 PI ☼		PB 32022 PI ☼		PB 16022 PV ☼		PB 32022 PV ☼	
PB 16032 PI ☼		PB 32032 PI ☼		PB 16032 PV ☼		PB 32032 PV ☼	
PB 16112 PI ☼		PB 32112 PI ☼		PB 16112 PV ☼		PB 32112 PV ☼	
PB 16102 PI ☼		PB 32102 PI ☼		PB 16102 PV ☼		PB 32102 PV ☼	
PB 16003 PI ☼		PB 32003 PI ☼		PB 16003 PV ☼		PB 32003 PV ☼	
PB 16123 PI ☼		PB 32123 PI ☼		PB 16123 PV ☼		PB 32123 PV ☼	
PB 16043 PI ☼		PB 32043 PI ☼		PB 16043 PV ☼		PB 32043 PV ☼	
PB 16023 PI ☼		PB 32023 PI ☼		PB 16023 PV ☼		PB 32023 PV ☼	
PB 16033 PI ☼		PB 32033 PI ☼		PB 16033 PV ☼		PB 32033 PV ☼	
PB 16113 PI ☼		PB 32113 PI ☼		PB 16113 PV ☼		PB 32113 PV ☼	

Dimensions in mm

(16 / 32A) PB ... PI

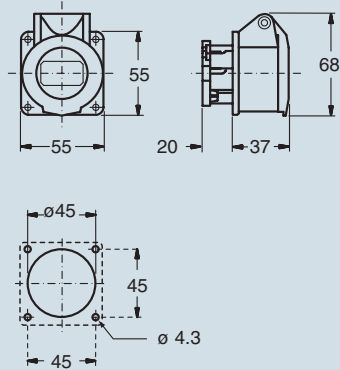

Dimensions in mm

(16 / 32A) PB ... PV

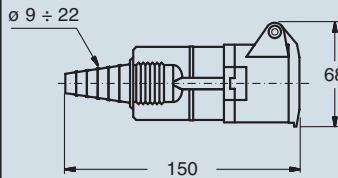

- Compliant with EN 60309-1 and -2
- Enclosure and insert in insulating, thermoplastic and self-extinguishing material
- RAL 7035 grey enclosure
- Plug mouth colour coded according to operating voltage and frequency
- PB...SM wall-mounting types, top entry with threaded grommet (replaceable with cable gland)
- PB...SV coupler types, cable anchoring collar incorporated in the collar, entry with grommet
- Terminals with retained screws
- Nickel-plated contacts on request
- IP44 degree of protection (EN 60529)
- ® With Italian Quality Mark

16A wall-mounting plugs
IP44 degree of protection



32A wall-mounting plugs
IP44 degree of protection



PB...SM

Number of poles	Frequency Hz	Voltage V	Earthing contact position h	Part No.	Colour	Part No.	Colour
2P	50 and 60	20 - 25	-	PB 16002 SM ®		PB 32002 SM ®	
	50 and 60	40 - 50	12	PB 16122 SM ®		PB 32122 SM ®	
	> 100 - 200 included	20 - 25 and 40 - 50	4	PB 16042 SM ®		PB 32042 SM ®	
	300	20 - 25 and 40 - 50	2	PB 16022 SM ®		PB 32022 SM ®	
	400	20 - 25 and 40 - 50	3	PB 16032 SM ®		PB 32032 SM ®	
	> 400 - 500 included	20 - 25 and 40 - 50	11	PB 16112 SM ®		PB 32112 SM ®	
	DC	20 - 25 and 40 - 50	10	PB 16102 SM ®		PB 32102 SM ®	
3P	50 and 60	20 - 25	-	PB 16003 SM ®		PB 32003 SM ®	
	50 and 60	40 - 50	12	PB 16123 SM ®		PB 32123 SM ®	
	> 100 - 200 included	20 - 25 and 40 - 50	4	PB 16043 SM ®		PB 32043 SM ®	
	300	20 - 25 and 40 - 50	2	PB 16023 SM ®		PB 32023 SM ®	
	400	20 - 25 and 40 - 50	3	PB 16033 SM ®		PB 32033 SM ®	
	> 400 - 500 included	20 - 25 and 40 - 50	11	PB 16113 SM ®		PB 32113 SM ®	

(*) Green may be used together with the colour of the operating range for frequencies above 60 Hz and up to a maximum of 500 Hz.

Dimensions in mm

(16 / 32A) PB ... SM

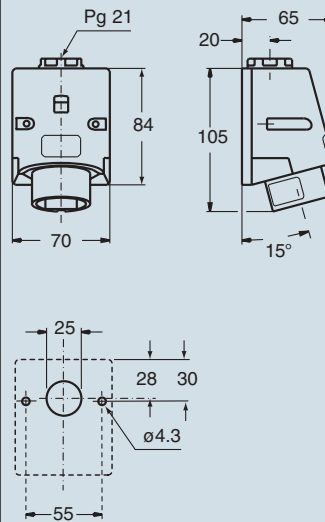

Dimensions indicated are not binding and may be changed without prior notice.

16A plugs
IP44 degree of protection

32A plugs
IP44 degree of protection



Part No.	Colour	Part No.	Colour
PB 16002 SV ☉		PB 32002 SV ☉	
PB 16122 SV ☉		PB 32122 SV ☉	
PB 16042 SV ☉		PB 32042 SV ☉	
PB 16022 SV ☉		PB 32022 SV ☉	
PB 16032 SV ☉		PB 32032 SV ☉	
PB 16112 SV ☉		PB 32112 SV ☉	
PB 16102 SV ☉		PB 32102 SV ☉	
PB 16003 SV ☉		PB 32003 SV ☉	
PB 16123 SV ☉		PB 32123 SV ☉	
PB 16043 SV ☉		PB 32043 SV ☉	
PB 16023 SV ☉		PB 32023 SV ☉	
PB 16033 SV ☉		PB 32033 SV ☉	
PB 16113 SV ☉		PB 32113 SV ☉	

Dimensions in mm

(16 / 32A) PB ... SV

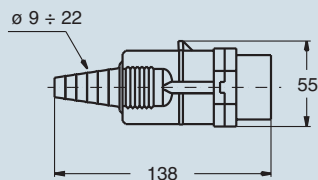

X-ON Electronics

Largest Supplier of Electrical and Electronic Components

Click to view similar products for [ilme manufacturer](#):

Other Similar products are found below :

[CSHF 10](#) [CZAP 25 L](#) [CDSHF 18](#) [CHI 06 LS](#) [TAPC 06 L25](#) [CHO 24](#) [CNEM 24 T](#) [TAPC 10.25](#) [TAPH 16.32](#) [TAPW 06 L25](#) [PE3264SV](#)
[PE1664SV](#) [CXM4/0](#) [COB 06 CMS](#) [APV21](#) [PEW3265PV](#) [CQEM18](#) [CCPZTP](#) [CZIR 06 L](#) [CHP 06 LS2](#) [TAPC 24.32](#) [TAVH 10 G32](#) [THCH](#)
[06 LG](#) [THIW 10](#) [THIW 16](#) [AS C21T](#) [PEW1663SV](#) [CQEF32](#) [CK 03 IAPNS](#) [TAVC 10 G32](#) [PE3265PV](#) [PE1643PI](#) [CHC10LG](#) [AS C36T](#)
[CDMD0.5](#) [CCMA4.0](#) [CSHM 24](#) [JNEM 06](#) [TAVW 10 G32](#) [CAVR 06 L21](#) [CK 03 C](#) [TAVC 06 LG25](#) [AS C16T](#) [AS C21O](#) [MHP 48 LS50](#)
[PEW3263PV](#) [CQEF10](#) [TAVH 10 G25](#) [CRR 36](#) [CRR 42](#)