Instruction Manual

General application Inverter

IMO iDrive2 XKL

CAUTION

Thank you for purchasing our iDrive2 XKL series of inverters.

- This product is designed to drive a three-phase induction motor. Read through this instruction manual and be familiar with the handling procedure for correct use.
- Improper handling might result in incorrect operation, a short life, or even a failure of this product as well as the motor.
- Deliver this manual to the end user of this product. Keep this manual in a safe place until this product is discarded.
- For how to use an optional device, refer to the instruction and installation manuals for that optional device.

Copyright © 2015 IMO Precision Controls Ltd

All rights reserved.

No part of this publication may be reproduced or copied without prior written permission from IMO Precision Controls Ltd.

All products and company names mentioned in this manual are trademarks or registered trademarks of their respective holders.

The information contained herein is subject to change without prior notice for improvement.

Content	
1 Safety Precautions.....	4
1.1 Safety definition	4
1.2 Warning symbols	4
1.3 Safety guidelines	4
2 Product overview	7
2.1 Quick start-up	7
2.2 Product specification.....	8
2.3 Name plate	10
2.4 Type designation key	10
2.5 Rated specifications.....	10
2.6 Structure diagram	10
3 Installation Guidelines.....	12
3.1 Mechanical installation.....	12
3.2 Standard wiring	14
3.3 Layout protection	16
4 Keypad Operation Procedure	18
4.1 Keypad displaying.....	19
4.2 Keypad operation.....	20
5 Function Parameters	22
6 Fault tracking	65
6.1 Maintenance intervals.....	65
6.2 Fault solution	68
7 Communication protocol	71
7.1 Brief instruction to Modbus protocol.....	71
7.2 Application of the inverter.....	71
7.3 RTU command code and communication data illustration	75
Appendix A Technical data	84
A.1 Ratings	84
A.2 CE	84
A.3 EMC regulations.....	85
Appendix B Dimension drawings	86
B.1 Keypad structure	86
B.2 Inverter chart	86
Appendix C Peripheral options and parts.....	87
C.1 Peripheral wiring.....	87
C.2 Power supply.....	88
C.3 Cables	88
C.4 Breaker and electromagnetic contactor.....	88
C.5 Reactors.....	89
C.6 Filter	89
C.7 Braking system.....	90
Appendix D Further information	92

1 Safety Precautions

Please read this manual carefully and follow all safety precautions before moving, installing, operating and servicing the inverter. If ignored, physical injury or death may occur, or damage may occur to the devices.









IMO are not responsible for any physical injury or death to persons or damage to the devices if the safety precautions in the manual are not complied with.

1.1 Safety definition



Danger:	Serious physical injury or even death may occur if Danger safety requirements are not followed.
Warning:	Physical injury or damage to the devices may occur if Warning safety requirements are not followed.
Note:	Physical injury may occur if above instructions are ignored.
Qualified electricians:	Only qualified Engineers with extensive knowledge and experience of commissioning and installation should attempt to install these devices. All safety precautions must be taken when installing.

1.2 Warning symbols

Warnings caution you about conditions which can result in serious injury or death and/or damage to the equipment, and advice on how to avoid the danger. The following warning symbols are used in this manual:

Symbols	Name	Instruction	Abbreviation
 Danger	Danger	Serious physical injury or even death may occur if requirements are not followed.	
 Warning	Warning	Physical injury or damage to the devices may occur if requirements are not followed.	
 Do not	Electrostatic discharge	Damage to the PCBA board may occur if requirements are not followed.	
 Hot sides	Hot sides	Sides of the device may become hot. Do not touch.	
Note	Note	Physical injury may occur if requirements are not followed.	Note

1.3 Safety guidelines

	<p>◇ Only qualified electricians are allowed to operate on the inverter.</p> <p>◇ Do not perform any wiring and inspection or changing components when the power supply is applied. Ensure all input power supply is disconnected before wiring and checking and always wait for at least the time designated on the inverter or until the DC bus voltage is less than 36V. Below is the table of the waiting time:</p> <table border="1"> <thead> <tr> <th colspan="2">Inverter module</th> <th>Minimum waiting time</th> </tr> </thead> <tbody> <tr> <td>Single-phase 230V</td> <td>0.4kW-2.2kW</td> <td>5 minutes</td> </tr> <tr> <td>Three-phase 400V</td> <td>0.75kW-2.2kW</td> <td>5 minutes</td> </tr> </tbody> </table>	Inverter module		Minimum waiting time	Single-phase 230V	0.4kW-2.2kW	5 minutes	Three-phase 400V	0.75kW-2.2kW	5 minutes
Inverter module		Minimum waiting time								
Single-phase 230V	0.4kW-2.2kW	5 minutes								
Three-phase 400V	0.75kW-2.2kW	5 minutes								
	◇ Install the inverter according to manual; otherwise fire, electric shock or other injury may occur.									
	◇ The base of the heatsink may become hot during running. Do not touch to avoid injury.									

	<ul style="list-style-type: none"> ✧ The electrical parts and components inside the inverter are electrostatic. Take precautions to avoid electrostatic discharge during relevant operation.
---	---

1.3.1 Delivery and installation

	<ul style="list-style-type: none"> ✧ Please install the inverter on fire-retardant material and keep the inverter away from combustible materials. ✧ Connect the optional braking components (braking resistors) according to the wiring diagram. ✧ Do not operate on the inverter if there is any damage or components loss to the inverter. ✧ Do not touch the inverter with wet items or body, risk of electric shock.
---	---

Note:

- ✧ Select appropriate moving and installing tools to ensure a safe and normal running of the inverter and avoid physical injury or death. For physical safety, the installer should take some mechanical protective measurements, such as wearing exposure shoes and working uniforms.
- ✧ Protect against physical damage or vibration during delivery and installation.
- ✧ Do not carry the inverter by its cover.
- ✧ Install away from children and other public places.
- ✧ The inverter cannot meet the requirements of low voltage protection in IEC61800-5-1 if the sea level of installation site is above 2000m.
- ✧ The Earth leakage current of the inverter may be above 3.5mA during operation. Ground with proper techniques and ensure the grounding resistor is less than 10Ω. The conductivity of PE grounding conductor is the same as that of the phase conductor (with the same cross sectional area).
- ✧ R, S and T are the input terminals of the power supply, while U, V and W are the motor terminals. Please connect the input power cables and motor cables correctly; otherwise the damage to the inverter may occur.

1.3.2 Commissioning and running

	<ul style="list-style-type: none"> ✧ Disconnect all power supplies applied to the inverter before the terminal wiring and wait for at least the designated time after disconnecting the power supply. ✧ High voltage is present inside the inverter during running. Do not carry out any operation except for the keypad setting. ✧ The inverter may auto start when P01.21=1. Do not get close to the inverter and motor. ✧ The inverter cannot be used as “Emergency-stop device”. ✧ The inverter cannot be used to brake the motor suddenly. A mechanical braking device should be used.
---	--

Note:

- ✧ Do not switch on/off the input power supply of the inverter frequently.
- ✧ For inverters that have been stored for a long time, check and fix the capacitance and try to run it again before use (see Maintenance and Hardware Fault Diagnosis).
- ✧ Replace top cover before running, otherwise electric shock may occur.

1.3.3 Maintenance and replacement of components

	<ul style="list-style-type: none"> ✧ Only qualified electricians should perform the maintenance, inspection, and components replacement of the inverter. ✧ Disconnect all power supplies to the inverter before the terminal wiring. Wait for at least the
---	--

	<p>time designated on the inverter after disconnection.</p> <ul style="list-style-type: none">✧ Take measures to avoid screws, cables and other conductive matters to falling into the inverter during maintenance and component replacement.
--	---

Note:

- ✧ Ensure screws are tightened to the correct torque.
- ✧ Keep the inverter, parts and components away from combustible materials during maintenance and component replacement.
- ✧ Do not perform any isolation and pressure test on the inverter and do not perform a megger test on the inverter.

1.3.4 What to do after scrapping

	<ul style="list-style-type: none">✧ The inverter contains hazardous materials. Dispose of according to WEEE regulations.
---	--

2 Product overview

2.1 Quick start-up

2.1.1 Unpacking inspection

Check as followings after receiving products:

- | |
|--|
| 1. Check that there is no physical or water damage to the package. Contact supplier immediately if received damaged. |
| 2. Check the information on the type designation label on the outside of the package to verify that the drive is of the correct type. If not, contact supplier immediately. |
| 3. Check that there are no signs of water in the package and no signs of damage or breach to the inverter. Contact supplier immediately if any damage. |
| 4. Check the information on the type designation label on the outside of the package to verify that the name plate is of the correct type. If not, contact supplier immediately. |
| 5. Check to ensure the accessories (including user's manual and control keypad) inside the device is complete. If not, contact supplier immediately. |

2.1.2 Application confirmation

Check the machine before beginning to use the inverter:

- | |
|---|
| 1. Check the load type to verify that there is no overload of the inverter during work and check the drive is the correct power rating. |
| 2. Check that the actual current of the motor is equal to or less than the rated current of the inverter. |
| 3. Check that the control accuracy of the load is the same of the inverter. |
| 4. Check that the incoming supply voltage is correspondent to the rated voltage of the inverter. |

2.1.3 Environment

Check as followings before the actual installation and usage:

- | |
|--|
| 1. Check that the ambient temperature of the inverter is below 40°C. If exceeds, derate 3% for every additional 1°C. Additionally, the inverter can not be used if the ambient temperature is above 50°C.
Note: for the cabinet inverter, the ambient temperature means the air temperature inside the cabinet. |
| 2. Check that the ambient temperature of the inverter in actual usage is above -10°C. If not, add heating facilities.
Note: for the cabinet inverter, the ambient temperature means the air temperature inside the cabinet. |
| 3. Check that the altitude of the actual usage site is below 1000m. If exceeds, derate 1% for every additional 100m. |
| 4. Check that the humidity of the actual usage site is below 90% and condensation is not allowed. If not, add additional ant-condensation heaters. |
| 5. Check that the actual usage site is away from direct sunlight and foreign objects can not enter the inverter. If not, add additional protective measures. |
| 6. Check that there is no conductive dust or flammable gas in the vicinity of the drive. If not, add additional protection to inverters. |

2.1.4 Installation confirmation

Check as followings after the installation:

- | |
|---|
| 1. Check that the load range of the input and output cables meet the need of actual load. |
|---|

2. Check that the accessories of the inverter are correctly and properly installed. The installation cables should meet the needs of every component (including reactors, input filters, output reactors, output filters, DC reactors and braking resistors).
3. Check that the inverter is installed on non-flammable materials and the calorific accessories (reactors and brake resistors) are away from flammable materials.
4. Check that all control cables and power cables are run separately and the routed to comply with EMC requirements.
5. Check that all grounding systems are properly grounded according to the requirements of the inverter.
6. Check that the free space during installation is sufficient according to the instructions in user's manual.
7. Check that the installation conforms to the instructions in user's manual. The drive must be installed in an upright position.
8. Check that the external connection terminals are tightly fastened and the torque is appropriate.
9. Check that there are no screws, cables and other conductive items left in the inverter.

2.1.5 Basic commissioning

Complete the basic commissioning as follows before actual operation:

1. Autotune. If possible, de-coupled from the motor load to start dynamic autotune. Or if not, static autotune is available.
2. Adjust the ACC/DEC time according to the actual running of the load.
3. Commission the device via jogging and check that the rotation direction is as required. If not, change the rotation direction by changing the wiring of motor.
4. Set all control parameters to suit application.

2.2 Product specification

Function		Specification
Power input	Input voltage (V)	Single-phase 220 (-15%)~240 (+10%) Three-phase 380 (-15%)~440 (+10%)
	Input current (A)	Refer to table 2.5
	Input frequency (Hz)	50Hz or 60Hz Allowed range: 47~63Hz
Power output	Output voltage (V)	=the input voltage (error<5%)
	Output current (A)	Refer to table 2.5
	Output power (kW)	Refer to table 2.5
	Output frequency (Hz)	50Hz/60Hz, fluctuation:±5%
Technical control	Control mode	V/F
	Maximum output frequency	400Hz
	Adjustable-speed ratio	1:100
	Overload capability	150% of rated current: 1 minute 180% of rated current: 10 seconds 200% of rated current: 1 second
Running control	Key functions	Stop mode and anti-temperature of the bus
	Temperature measurement accuracy	Overtemperature point ±3℃
	Terminal switch input	≤ 2ms

Function		Specification
	resolution	
	Terminal analog input resolution	≤ 20mV
	Analog input	1 input 0~10V/0~20mA
	Analog output	1 input 0~10V/0~20mA
	Digital input	5 common input
	Digital output	1 Y output (commonly used with digital output) and 1 programmable relay output
	Communication	485 communication
	Frequency setting	Digital setting, analog setting, multi-step speed setting, PID setting, MODBUS communication setting and so on Switch between different settings
	Automatic voltage adjustment	Keeps output voltage stable when the grid voltage changes
	Fault protection	More than 10 fault protections
Others	Mountable method	Wall mountable
	Temperature of the running environment	-10~50℃, derate above 40℃
	Cooling	Single/three-phase 230V 0.2-0.75kW natural cooling Single/three-phase 230V 1.5-2.2kW, three-phase 380V 0.75-2.2kW
	Enclosure	IP20
	Braking unit	Embedded
	DC reactor	Not optional
	Braking resistor	Optional and external
	Optional EMC filters	C2 or C3 filter options

2.3 Name plate

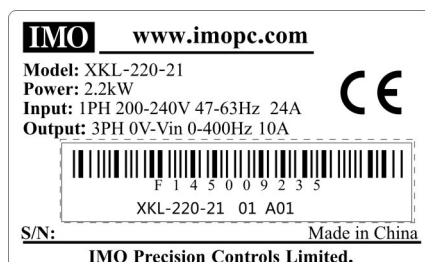

Fig 2-1 Name plate

2.4 Type designation key

The type designation contains information on the inverter. The user can find the type designation on the type designation label attached to the inverter or the simple name plate.

XKL - 220 - 2 1

① ② ③ ④

Fig 2-2 Product type

Field identification	Sign	Detailed description of the sign	Detailed content
Abbreviation	①	Product abbreviation	Series = XKL
Rated power	②	Power range	220 = 2.2kW
Voltage	③	Supply voltage	4: 380 (-15%)~440 (+10%) 2: 220 (-15%)~240 (+10%)
Phase	④	Input Phase	1 = 1Phase 3 = 3Phase

2.5 Rated specifications

	Model	Output power (kW)	Input current (A)	Output current (A)
Single-phase 230V	XKL-040-21	0.4	6.5	2.5
	XKL-075-21	0.75	9.3	4.2
	XKL-150-21	1.5	15.7	7.5
	XKL-220-21	2.2	24	10
Three-phase 400V	XKL-075-43	0.75	3.2	2.5
	XKL-150-43	1.5	4.3	4.2
	XKL-220-43	2.2	7.1	5.5

2.6 Structure diagram

Below is the layout figure of the inverter (take the inverter of 2.2kW as the example).

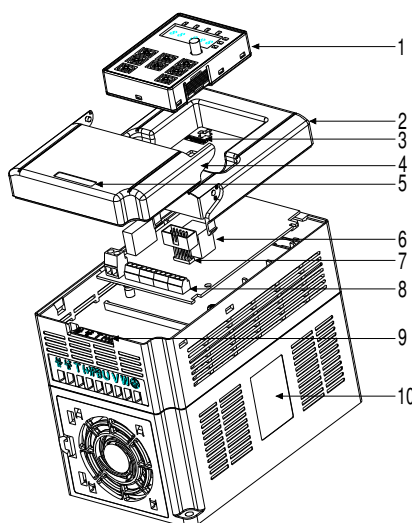



Fig 2-3 Product structure diagram

Serial No.	Name	Illustration
1	Keypad	See Keypad Operation Procedure for detailed information
2	Cover	Protects the internal parts and components
3	POWER indicator	POWER indicator
4	Side cover	Protects the internal components
5	Simple name plate	See Type Designation Key for detailed information
6	Keypad port	Connect the keypad
7		6 is for external installation
8	Main circuit terminals	See Electric Installation for detailed information
9	Control circuit terminals	See Electric Installation for detailed information
10	Name plate	See Product Overview for detailed information

3 Installation Guidelines

This chapter describes the mechanical installation and electric installation.

	<ul style="list-style-type: none"> ✧ Only qualified electricians are allowed to carry out what described in this chapter. Please operate as the instructions in Safety Precautions. Ignoring these may cause physical injury or death or damage to the devices. ✧ Ensure the power supply of the inverter is disconnected during the operation. Wait for at least the time designated until the POWER indicator is off after the disconnection if the power supply is applied. ✧ The installation and design of the inverter should be comply with the requirement of the local laws and regulations at the installation site. If the installation infringes the requirement, IMO will exempt from any responsibility. Additionally, if users do not comply with the recommendation, some damage beyond the assured maintenance range may occur.
---	---

3.1 Mechanical installation

3.1.1 Installation environment

The installation environment is the safeguard for a full performance and long-term operation of the inverter. Check the installation environment as following:

Environment	Conditions
Installation site	Indoor
Environment temperature	<p>-10℃ ~+40℃, and the temperature changing rate is less than 0.5℃/minute.</p> <p>If the ambient temperature of the inverter is above 40℃, derate 3% for every additional 1℃.</p> <p>It is not recommended to use the inverter if the ambient temperature is above 60℃.</p> <p>In order to improve the reliability of the device, do not use the inverter if the ambient temperature changes frequently.</p> <p>Please provide cooling fan or air conditioner to control the internal ambient temperature below the max limit if the inverter is used in a close space such as in a control cabinet.</p> <p>When the temperature is too low, if the inverter needs to restart to run after a long stop, it is necessary to provide an external heating device to increase the internal temperature, otherwise damage to the devices may occur.</p>
Humidity	<p>RH≤90%</p> <p>Prevent condensation.</p> <p>The maximum relative humidity should be equal to or less than 60% in corrosive air.</p>
Storage temperature	-40 ℃ ~+70℃, and the temperature changing rate is less than 1℃/minute.
Running environment condition	<p>The installation site of the inverter should be kept away from ant electromagnetic radiation source;</p> <p>kept away from contaminative air, such as corrosive gas, oil mist and flammable gas;</p>

Environment	Conditions
	Ensure foreign objects, such as metal, dust, oil, water can not enter into the inverter (do not install the inverter on flammable materials such as wood); Keep out of direct sunlight, oil mist, steam and vibration.
Altitude	Below 1000m If the sea level is above 1000m, please derate 1% for every additional 100m.
Vibration	$\leq 5.8\text{m/s}^2(0.6\text{g})$
Installation direction	The inverter should be installed on an upright position to ensure sufficient cooling effect.

Note:

- ◆ IMO XKL series inverters should be installed in a clean and well ventilated environment according to enclosure classification.
- ◆ Cooling air must be clean, free from corrosive materials and electrically conductive dust.

3.1.2 Installation direction

The inverter may be installed on the wall or in a cabinet.

The inverter must be installed in an upright position. Check the installation site according to the requirements below. Refer to chapter **Dimension Drawings** in the appendix for frame details.

3.1.3 Installation manner

The inverter can be installed in wall mounting (for all frame sizes):

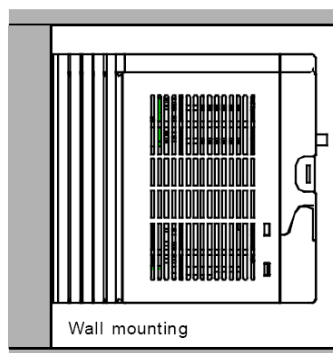

Fig 3-1 Installation mounting

- (1) Mark the hole location. The location of the holes is shown in the dimension drawings in the appendix.
- (2) Fix screws or bolts to the marked locations.
- (3) Position the drive onto backplate.
- (4) Tighten the screws in the backplate securely.

3.1.4 Installation space

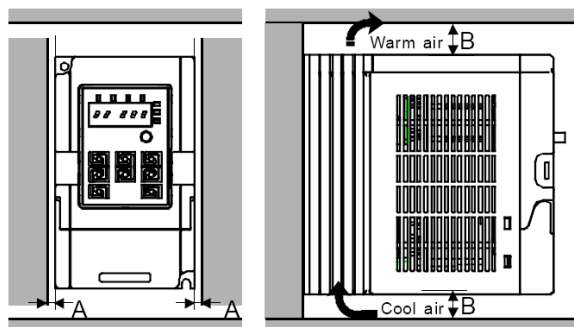

Fig 3-2 Installation space

Note: Fan cooled drives can be mounted side by side, natural cooled drives require 30mm clearance (Dim A) A minimum clearance of 100mm is required above and below the drive (Dim B).

3.2 Standard wiring

3.2.1 Connection diagram of main circuit

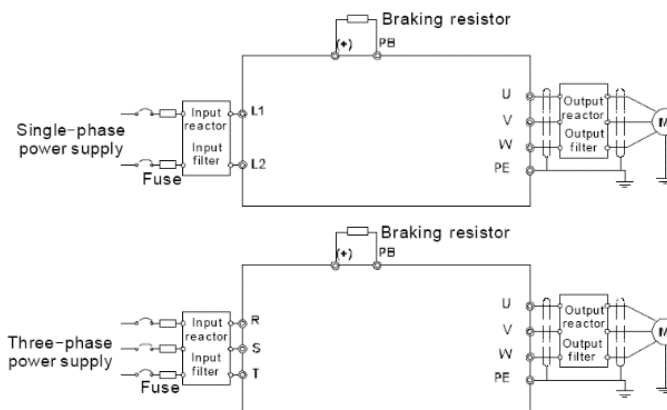

Diagram 3-3 Connection diagram of main circuit

Note:

- ◆ The fuse, DC reactor, braking resistor, input reactor, input filter, output reactor, output filter are optional parts. Please refer to **Peripheral Optional Parts** for detailed information.

3.2.2 Terminals figure of main circuit

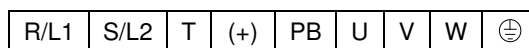

Fig 3-4 Terminals of main circuit

Terminal sign	Terminal name	Function
L1/R	Power input of the main circuit	3-phase/1-phase AC input terminals are generally connected to the incoming supply.
L2/S		
T		
U	The inverter output	3-phase AC output terminals are generally connected to the motor.
V		
W		
PB	Braking resistor terminal	PB and (+) are connected to an external resistor.

Terminal sign	Terminal name	Function
(+)		
⊖	Grounding terminal	Each machine has a standard PE terminal.

Note:

- ◆ Do not use an asymmetrically constructed motor cable. If there is a symmetrically constructed grounding conductor in the motor cable in addition to the conductive shield, connect the grounding conductor to the grounding terminal at the inverter and motor ends.
- ◆ Route the motor cable, input power cable and control cables separately.
- ◆ Terminal “T” is not used with single-phase input inverters.

3.2.3 Wiring of terminals in main circuit

1. Connect the grounding conductor of the input power cable with the grounding terminal of the inverter (**PE**) by **360** degree grounding technique. Connect the incoming supply to **R/L1, S/L2** and **T** terminals and fasten.
2. Strip the motor cable and connect the shield to the grounding terminal of the inverter by **360** degree grounding technique. Connect the motor to **U, V** and **W** terminals on drive and fasten.
3. Connect the optional brake resistor with a shielded cable to the designated position by the same procedures in the previous step.
4. Secure the cables outside the inverter mechanically.

3.2.4 Connection diagram of the control circuit

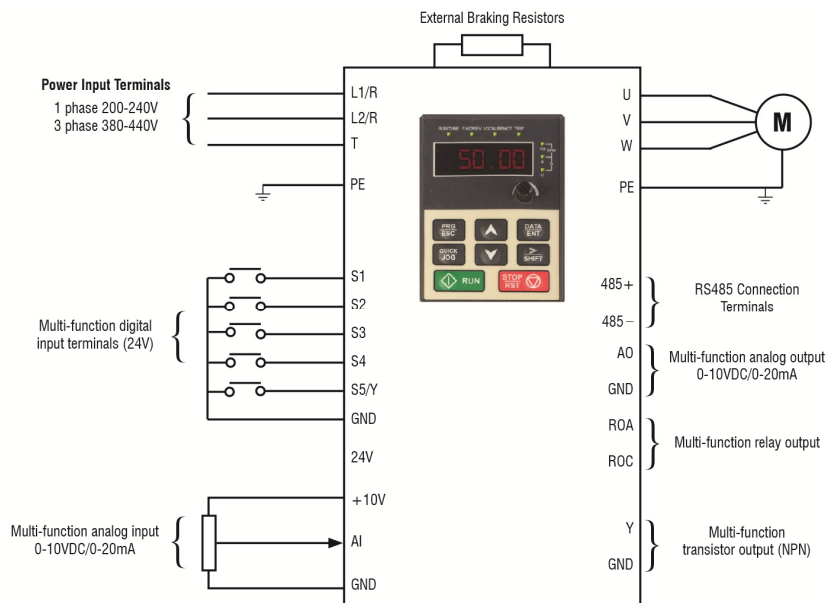

Figure 3-5 Connection diagram of the control circuit.

3.2.5 Wiring diagram of control circuit

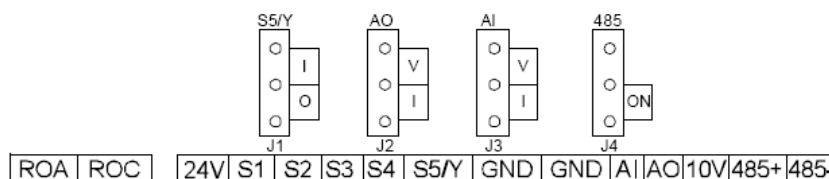

Fig 3-6 Wiring of control circuit

Description		
ROA	Output relay N/O terminal	(Relay contact rating: 3A/AC250V,1A/DC30V)
ROC	Output relay common terminal	
+10V	Local power supply +10Vdc for analog inputs.	
AI	1. Input range: AI voltage and current: 0~10V/0~20mA and switch by J3 2. Input impedance:voltage input: 20kΩ; current input: 500Ω 3. Resolution: the minimum is 5mV when 10V corresponds to 50Hz 4. Deviation ±1%, 25℃ Note: Keypad potentiometer set by parameter AI1, external input set by parameter AI2.	
24V	Local +24V power supply, 100mA	
GND	+10V reference zero potential	
AO	1. Output range:0~10V or 0~20mA 2. The voltage/current is selected by jumper J2 3. Deviation±1%,25℃	
S1	Switch input 1	1. Internal impedance:3.3kΩ 2. 0~4V corresponds to low electric level input and 7~30V corresponds to high electric level input 3. Max input frequency:1kHz 4. All are programmable digital input terminal. User can set the terminal function through function codes.
S2	Switch input 2	
S3	Switch input 3	
S4	Switch input 4	
S5	Switch input 5	
Y	Digital output terminal	Note : S5 and Y can not be used at the same time
485+	485 communication interface and 485 differential signal interface	
485-	For standard 485 communication interface, please use twisted pairs or shield cable.	

3.3 Layout protection

3.3.1 Protect the inverter and input power cable in short-circuit situations

Protect the inverter and input power cable in short circuit situations and against thermal overload.

Arrange the protection according to the following guidelines.

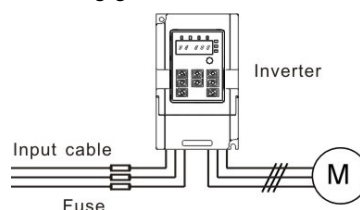



Fig 3-10 Fuse configuration

Note: Select the fuse specified in this manual. The fuse will protect the input power cable from short circuit. It will protect the surrounding devices in case of inverter internal short circuit.

3.3.2 Protecting the motor and motor cables

The inverter protects the motor and motor cable in a short-circuit situation when the motor cable is sized according to the rated current of the inverter. No additional protection devices are required.

	✧ If the inverter is connected to multiple motors, a separate thermal overload switch or a circuit breaker must be used for protecting each cable and motor. These devices may require a separate fuse for protection.
---	--

3.3.3 Implementing a bypass connection

It may be necessary to set power frequency and variable frequency conversion circuits for the assurance of continuous normal work of the inverter if faults.

In some special situations, for example, if it is only used in soft start, the inverter can be converted into power frequency running after starting and some corresponding bypass should be added.

	✧ Never connect the supply power to the inverter output terminals U, V and W. Power line voltage applied to the output can result in permanent damage to the inverter.
---	--

If frequent switching between units is required, use contactors with mechanical interlock to ensure that the motor terminals are not connected to the AC power line and inverter output terminals simultaneously.

4 Keypad Operation Procedure

The keypad is used to control *iDrive2* XKL series inverters, display active data and adjust parameters.

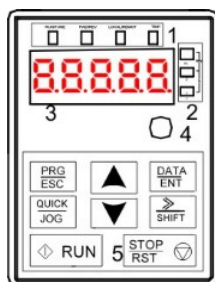









Fig 4-1 Keypad

Note: Fix the external keypad with M3 screws or the installation bracket. The installation bracket is optional.

Serial No.	Name	Description	
1	State LED	RUN/TUNE	LED off means that the inverter is in stopped state; LED flashing means the inverter is in parameter autotune state; LED on means the inverter is in running state.
		FWD/REV	FWD/REV LED LED off means the inverter is in forward rotation state; LED on means the inverter is in reverse rotation state
		LOCAL/REMOT	LED for keypad operation, terminals operation and remote communication control. LED off means that the inverter is in keypad control; LED flashing means the inverter is in terminal control; LED on means the inverter is in communication control.
		TRIP	LED for faults LED on when the inverter is in fault state; LED off in normal state; LED flashing means the inverter is in overload pre-alarm state.
2	Unit LED	Signifies the current unit type being displayed.	
		Hz	Frequency
		RPM	Rotating speed
		A	Current
		%	Percentage
	V	Voltage	
3	Code displaying zone	5-digit LED display displays various monitoring data and alarm code such as set frequency and output frequency.	

Serial No.	Name	Description					
		Displayed word	Corresponding word	Displayed word	Corresponding word	Displayed word	Corresponding word
		0	0	1	1	2	2
		3	3	4	4	5	5
		6	6	7	7	8	8
		9	9	A	A	B	B
		C	C	d	d	E	E
		F	F	H	H	I	I
		L	L	N	N	n	n
		o	o	P	P	r	r
		S	S	t	t	U	U
		v	v	.	.	-	-
4	Digital potentiometer	Corresponds to AI1.					
5	Keys		Program key	Enter or escape from the first level menu and remove the parameter quickly			
			Entry key	Enter the menu step-by-step Confirm parameters			
			UP key	Increase data or function code progressively			
			DOWN key	Decrease data or function code progressively			
			Right-shift key	Move right to select the displaying parameter circularly in stopping and running mode. Select the parameter modifying digit during the parameter modification			
			Run key	This key is used to run the inverter in key operation mode			
			Stop/Reset key	This key is used to stop in running state and it is limited by function code P07.04 This key is used to reset all control modes in the fault alarm state			
			Quick key	The function of this key is confirmed by function code P07.02.			

4.1 Keypad display

The keypad display of IMO XKL series inverters is divided into stopped state parameter, running state parameter, function code parameter editing state and fault alarm state etc.

4.1.1 Display state of stopped parameter

When the inverter is in the stopped state, the keypad will display stop parameters which is shown in figure 4-2.

In the stopped state, various kinds of parameters can be displayed. Select the parameters to be displayed or not by P07.07. See the instructions of P07.07 for the detailed definition of each setting.

In the stopped state, there are 14 stopped parameters can be selected to be displayed or not. They are: set frequency, bus voltage, input terminals state, output terminals state, PID reference, PID feedback, AI1, AI2 and the current stage of multi-stage speeds, pulse counting value. P07.07 can select the parameter to be displayed or not by bit and **▶/SHIFT** can shift the parameters form left to right, **QUICK/JOG**(P07.02=2) can shift the parameters form right to left.

4.2.2 Display state of running parameters

After the inverter receives valid run commands, the inverter will enter into the run state and the keypad will display the running parameters. **RUN/TUNE** LED on the keypad is on, while the **FWD/REV** is determined by the current running direction which is shown as figure 4-2.

In the run state, there are 22 parameters can be selected to be displayed or not. They are: running frequency, set frequency, bus voltage, output voltage, output torque, PID reference, PID feedback, input terminals state, output terminals state, and the current stage of multi-stage speeds, pulse counting value, AI1, AI2, percentage of motor overload, percentage of inverter overload, linear speed. P07.05 and P07.06 can select the parameter to be displayed or not by bit and **▶/SHIFT** can shift the parameters form left to right, **QUICK/JOG**(P07.02=2) can shift the parameters from right to left.

4.1.3 Display state of fault

When the inverter detects a fault, it will enter into the fault pre-alarm display state. The keypad will display the fault code and the **TRIP** LED will flash. The trip can be reset by pressing **STOP/RST**

4.1.4 Displayed state of function codes editing

In stop state, running or fault, press **PRG/ESC** to enter into the editing state (if there is a password, see P07.00).The editing state is displayed on two classes of menu, and the order is: function code group/function code number→function code parameter, press **DATA/ENT** into the displayed state of function parameter. On this state, press **DATA/ENT** to save the parameters or press **PRG/ESC** to escape.

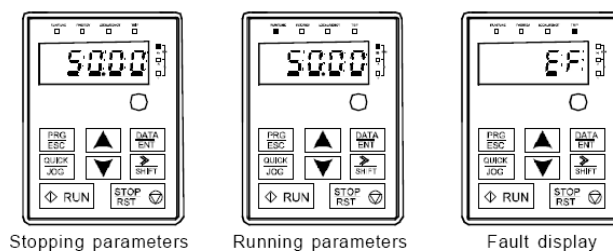

Fig 4-2 Displayed state

4.2 Keypad operation

Operate the inverter via keypad. See the detailed structure description of function codes in the brief diagram of function codes.

4.2.1 How to modify the function codes of the inverter

The inverter has three levels menu, which are:

1. Group number of function code (first-level menu)
2. Tab of function code (second-level menu)

3. Set value of function code (third-level menu)

Remarks: Press both the **PRG/ESC** and the **DATA/ENT** can return to the second-level menu from the third-level menu. The difference is: pressing **DATA/ENT** will save the set parameters into the control panel, and then return to the second-level menu with shifting to the next function code automatically; while pressing **PRG/ESC** will directly return to the second-level menu without saving the parameters, and keep staying at the current function code.

Under the third-level menu, if the parameter has no blinking bit, it means the function code cannot be modified. The possible reasons could be:

- 1) This function code is not modifiable parameter, such as actual detected parameter, operation records and so on;
- 2) This function code is not modifiable in running state, but modifiable in stop state.

Example: Set function code P00.01 from 0 to 1.

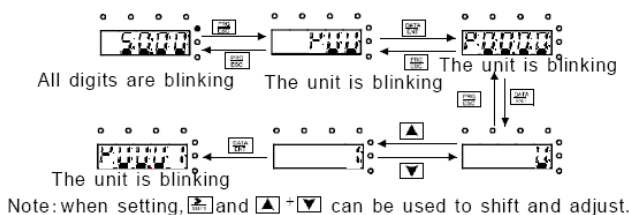

Fig 4-3 Flow diagram of modifying parameters

4.2.2 How to set the password of the inverter

IMO XKL series inverters provide password protection function for users. Use P7.00 to set a password, the password protection becomes valid instantly after quitting from the function code editing state. Press **PRG/ESC** again to the function code editing state, "0.0.0.0.0" will be displayed. Unless using the correct password, the operators cannot enter it.

Set P7.00 to 0 to cancel password protection function.

The password protection becomes valid instantly after retreating from the function code editing state. Press **PRG/ESC** again to the function code editing state, "0.0.0.0.0" will be displayed. Unless using the correct password, the operators cannot enter it.

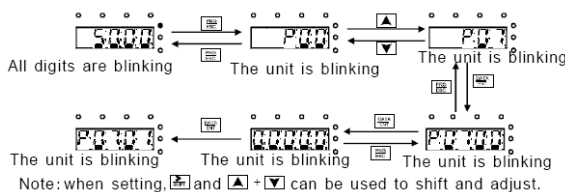

Fig 4-4 Flow diagram of password setting

4.2.3 How to monitor the inverter state through function codes

IMO XKL series inverters provide group P17 as the state inspection group. Users can enter into P17 directly to monitor the state.

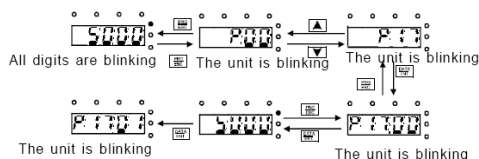

Fig 4-5 Flow diagram of state monitoring

5 Function Parameters

The function parameters of iDrive2 XKL series inverters have been divided into 30 groups (P00~P29) according to the function, of which P18~P28 are reserved. Each function group contains certain function codes applying 3-level menus. For example, "P08.08" means the eighth function code in the P8 group function, P29 group is factory reserved, and users are unable to access these parameters.

For simplicity of function codes setting, the function group number corresponds to the first level menu, the function code corresponds to the second level menu and the function code corresponds to the third level menu.

Parameter Menu.

Menu	Sub Menu	Description	Examples of Functions
P00	P00.00 – P00.18	Basic parameters	Run command type, Max frequency, ramp times
P01	P01.00 – P01.24	Start/Stop control	DC injection braking, coast to stop, delay start, auto restart
P02	P02.00 – P02.27	Motor 1 settings	Motor ratings, Kw, Current, speed
P04	P04.00 – P04.24	V/F control	Torque boost, slip compensation, V/F curve
P05	P05.00 – P05.41	Input terminals	Set function of digital inputs S1-S5
P06	P06.00 – P06.21	Output terminals	Set function of relay, transistor and analogue outputs
P07	P07.00 – P07.56	Keypad/HMI settings	Set user password, quick key function and display
P08	P08.00 – P08.50	Enhanced functions	Jogging, cooling fan and dynamic braking functions
P09	P09.00 – P09.13	PID control settings	PID, SV and feedback source settings
P10	P10.00 – P10.32	Pre-set speeds & PLC	Pre-set speed values & PLC selection
P11	P11.00 – P11.13	Protective functions	Set protective function trip/output levels
P14	P14.00 – P14.06	Comms settings	Baud rate, check bits and other Modbus/RS485 settings
P17	P17.00 – P17.37	Monitoring	Monitor live values of inverter during operation

1. Below is the instruction of the function lists:

The first column "Function code": code of function parameter group and parameters;

The second column "Name": full name of function parameters;

The third column "Detailed illustration of parameters": Detailed explanation of the function parameters

The fourth column "Default value": the original factory set value of the function parameter;

The fifth column "Modify": shows the modification ability of the parameter according to the list:-

"○": means the set value of the parameter can be modified in stop and running state;

"⊙": means the set value of the parameter can only be modified in stop state;

"●": means the value of the parameter is the real detection value which can not be modified.

Function code	Name	Detailed instruction of parameters	Default value	Modify
P00 Group Basic function group				
P00.00	Speed control mode	2:PWM control (suitable for AM) 2 is suitable in cases where it does not need high control accuracy, such as the load of fan and pump. One inverter can drive multiple motors.	2	⊙

Function code	Name	Detailed instruction of parameters	Default value	Modify
P00.01	Run command method	<p>Selects the run command method of the inverter.</p> <p>The control command of the inverter includes: start, stop, forward, reverse, jogging and fault reset.</p> <p>0:Keypad run command method (“LOCAL/REMOT” light off)</p> <p>Run command control by RUN, STOP/RST on the keypad.</p> <p>Set the multi-function key QUICK/JOG to FWD/REV shifting function (P07.02=3) to change the running direction; press RUN and STOP/RST simultaneously in running state to make the inverter coast to stop.</p> <p>1:Terminal run command method (“LOCAL/REMOT” flashing)</p> <p>Terminal run command control by the forward rotation, reverse rotation and forward jogging and reverse jogging of the multi-function terminals</p> <p>2:Communication run command method (“LOCAL/REMOT” on);</p> <p>The running command is controlled by via communication</p>	0	○
P00.03	Max. output frequency	<p>Sets the maximum output frequency of the drive.</p> <p>Acceleration and deceleration times are based on this setting.</p> <p>Setting range: P00.04~400.00Hz</p>	50.00Hz	◎
P00.04	Output frequency high limit	<p>Limits the maximum running frequency.</p> <p>Setting range:P00.05~P00.03 (Max. output frequency)</p>	50.00Hz	◎
P00.05	Output frequency low limit	<p>Limits the minimum running frequency.</p> <p>The inverter runs at the lower limit frequency even if the set frequency is lower than the low limit setting.</p> <p>Note: Max. Output frequency ≥ Frequency high limit ≥ Frequency low limit.</p> <p>Setting range:0Hz~P00.04 (Frequency high limit.).</p>	0.00Hz	◎
P00.06	A. frequency command selection	<p>0:Keypad data setting.</p> <p>Modify the value of function code P00.10 (set the frequency by keypad) to modify the frequency by the keypad.</p>	0	○
P00.07	B. frequency	<p>1:Analog AI1 setting</p>	2	○

Function code	Name	Detailed instruction of parameters	Default value	Modify
	command selection	<p>2:Analog AI2 setting</p> <p>Analog input terminal sets the frequency. There are 2 standard analog input terminal, of which AI1 is adjusted through digital potentiometer, AI2 (0~10V/0~20mA) this is set by the jumper.</p> <p>Note: when AI2 selects 0~20mA input, 20mA corresponds to 10V.</p> <p>100.0% of the analog input corresponds to P00.03, -100.0% of the analog input corresponds to the reverse P00.03.</p> <p>6: Multi-stage speed running setting</p> <p>The inverter runs at multi-stage speed mode when P00.06=6 or P00.07=6. Set P05 to select the current running stage, and set P10 to select the current running frequency.</p> <p>The multi-stage speed has the priority when P00.06 or P00.07 does not equal to 6, but the setting stage can only be the 1~15 stage. The setting stage is 1~15 if P00.06 or P00.07 equals to 6.</p> <p>7: PID control setting</p> <p>The running mode of the inverter is process PID control when P00.06=7 or P00.07=7. It is necessary to set P09. The running frequency of the inverter is the value after PID effect. See P09 for the detailed information of the preset source, preset value, feed-back source of PID.</p> <p>8:MODBUS communication setting</p> <p>The frequency is set by MODBUS communication. See P14 for detailed information.</p> <p>Note: A frequency and B frequency can not set as the same frequency reference method.</p>		
P00.08	B frequency command reference	<p>0: Maximum output frequency, 100% of B frequency setting corresponds to the maximum output frequency</p> <p>1: A frequency command, 100% of B frequency setting corresponds to the maximum output frequency. Select this setting if it needs to adjust on the base of A frequency command</p>	0	○
P00.09	Combination type of the	0: A, the current frequency setting is A frequency command	0	○

Function code	Name	Detailed instruction of parameters	Default value	Modify
	setting source	<p>1: B, the current frequency setting is B frequency command</p> <p>2: A+B, the current frequency setting is sum of A+B frequency command.</p> <p>3: A-B, the current frequency setting is A frequency command - B frequency command</p> <p>4: Max (A, B): The highest value of A and B is the set frequency.</p> <p>5: Min (A, B): The lowest value of A and B is the set frequency.</p> <p>Note:The combination manner can be shifted by P05(terminal function).</p>		
P00.10	Keypad set frequency	<p>When A and B frequency commands are selected as "keypad setting", this parameter will be the initial value of inverter reference frequency</p> <p>Setting range:0.00 Hz~P00.03(the Max. frequency)</p>	50.00Hz	<input type="radio"/>
P00.11	ACC time 1	Time (secs) to ramp up to Max frequency (P00.03) from 0Hz.	Depend on model	<input type="radio"/>
P00.12	DEC time 1	<p>Time (secs) to ramp down from Max frequency (P00.03) to 0Hz.</p> <p>IMO XKL series inverters define four groups of ACC/DEC time which can be selected by P05. The factory default ACC/DEC time of the inverter is the first group.</p> <p>Setting range of P00.11 and P00.12:0.0~3600.0s</p>	Depend on model	<input type="radio"/>
P00.13	Running direction selection	<p>0: Runs at the default direction, the inverter runs in the forward direction. FWD/REV indicator is off.</p> <p>1: Runs at the opposite direction, the inverter runs in the reverse direction. FWD/REV indicator is on.</p> <p>Modify the function code to shift the rotation direction of the motor. The motor rotation direction can be changed by QUICK/JOG on the keypad. Refer to parameter P07.02.</p> <p>Note: Factory reset returns motor direction to default, check direction of motor is correct before running after reset.</p> <p>2: Forward run only: Prevents motor running in reverse direction.</p>	0	<input type="radio"/>

Function code	Name	Detailed instruction of parameters	Default value	Modify																				
P00.14	Carrier frequency setting	<table border="1" style="margin-left: auto; margin-right: auto;"> <tr> <td>Carrier frequency</td> <td>RFI noise</td> <td>Earth leakage</td> <td>Heat generation</td> </tr> <tr> <td>1kHz</td> <td style="text-align: center;">▲ High</td> <td style="text-align: center;">▲ Low</td> <td style="text-align: center;">▲ Low</td> </tr> <tr> <td>4 kHz</td> <td></td> <td></td> <td></td> </tr> <tr> <td>8kHz</td> <td style="text-align: center;">▼ Low</td> <td style="text-align: center;">▼ High</td> <td style="text-align: center;">▼ High</td> </tr> </table> <p>The relationship table of the motor type and carrier frequency:</p> <table border="1" style="margin-left: auto; margin-right: auto;"> <tr> <th>Motor type</th> <th>The factory value of carrier frequency</th> </tr> <tr> <td>0.2~2.2kW</td> <td style="text-align: center;">4kHz</td> </tr> </table> <p>The advantage of high carrier frequency: ideal current waveform, little current harmonic wave and motor noise. The disadvantage of high carrier frequency: increasing the switch loss, increasing inverter temperature and the impact to the output capacity. The inverter needs to derate on high carrier frequency. At the same time, the leakage and electrical magnetic interference will increase. Applying low carrier frequency is contrary to the above, too low carrier frequency will cause unstable running, torque decreasing and surge. The default setting of 4KHz is suitable for most general applications and should not need to be changed. When the frequency used exceeds the default carrier frequency, the inverter needs to derate 20% for each additional 1k carrier frequency. Setting range:1.0~8.0kHz</p>	Carrier frequency	RFI noise	Earth leakage	Heat generation	1kHz	▲ High	▲ Low	▲ Low	4 kHz				8kHz	▼ Low	▼ High	▼ High	Motor type	The factory value of carrier frequency	0.2~2.2kW	4kHz	Depend on model	○
Carrier frequency	RFI noise	Earth leakage	Heat generation																					
1kHz	▲ High	▲ Low	▲ Low																					
4 kHz																								
8kHz	▼ Low	▼ High	▼ High																					
Motor type	The factory value of carrier frequency																							
0.2~2.2kW	4kHz																							
P00.16	AVR function selection	0:Invalid 1:Valid during the whole procedure. The auto-adjusting function of the inverter can cancel the impact on the output voltage of the inverter because of the bus voltage fluctuation.	1	○																				
P00.18	Function restore parameter	0:No operation 1:Restore the default value 2:Clear fault records Note: The function code will restore to 0 after finishing the operation of the selected function code.	0	◎																				

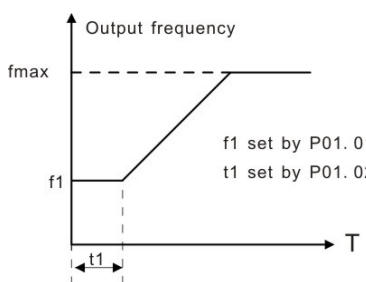
Function code	Name	Detailed instruction of parameters	Default value	Modify
		Restoring to the default value will cancel the user password, please use this function with caution.		
P01 Group Start-up and stop control				
P01.00	Start mode	0:Start-up directly:start from the starting frequency P01.01 1:Start-up after DC braking: start the motor from the starting frequency after DC braking (set the parameter P01.03 and P01.04). It is suitable in the cases where reverse rotation may occur to the low inertia load during starting.	0	⊙
P01.01	Starting frequency of direct start-up	Starting frequency of direct start-up means the original frequency during the inverter starting. See P01.02 for detailed information. Setting range: 0.00~50.00Hz	0.50Hz	⊙
P01.02	Retention time of the starting frequency	Set a proper starting frequency to increase the torque of the inverter during starting. During the retention time of the starting frequency, the output frequency of the inverter is the starting frequency. And then, the inverter will run from the starting frequency to the set frequency. If the set frequency is lower than the starting frequency, the inverter will stop running and keep in the stand-by state. The starting frequency is not limited in the lower limit frequency.  Setting range: 0.0~50.0s	0.0s	⊙
P01.03	The braking current before starting	The inverter will carry out DC braking at the braking current set before starting and it will speed up after the DC braking time. If the DC braking time is set to 0, the DC braking is invalid.	0.0%	⊙
P01.04	The braking time before	The stronger the braking current, the bigger the braking power. The DC braking current before starting means	0.00s	⊙

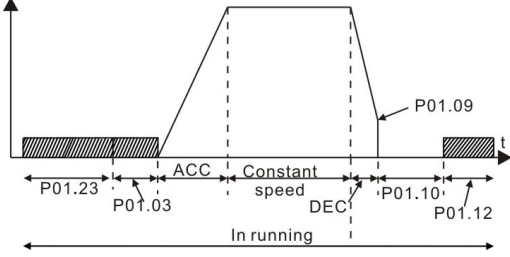
Function code	Name	Detailed instruction of parameters	Default value	Modify
	starting	the percentage of the rated current of the inverter. The setting range of P01.03: 0.0~100.0% The setting range of P01.04: 0.0~50.0s		
P01.05	ACC/DEC selection	The changing mode of the frequency during start-up and running. 0:Linear type The output frequency increases or decreases linearly.	0	⊙
P01.08	Stop selection	0: Decelerate to stop: after the stop command becomes valid, the inverter decelerates to decrease the output frequency during the set time. When the frequency decreases to 0, the inverter stops. 1: Coast to stop: after the stop command becomes valid, the inverter ceases the output immediately. And the load coasts to stop at the mechanical inertia.	0	○
P01.09	Starting frequency of DC braking	Starting frequency of DC braking: start the DC braking when running frequency reaches starting frequency determined by P1.09.	0.00Hz	○
P01.10	Waiting time before DC braking	Waiting time before DC braking: Inverters block the output before starting the DC braking. After this waiting time, the DC braking will be started so as to prevent over-current fault caused by DC braking at high speed.	0.00s	○
P01.11	DC braking current	DC braking current : The value of P01.11 is the percentage of rated current of inverter. The bigger the DC braking current is, the greater the braking torque is.	0.0%	○
P01.12	DC braking time	DC braking time: The retention time of DC brake. If the time is 0, the DC brake is invalid. The inverter will stop at the set deceleration time. 	0.00s	○
		The setting range of P01.09: 0.00Hz~P00.03 The setting range of P01.10: 0.0~50.0s The setting range of P01.11: 0.0~100.0% The setting range of P01.12: 0.0~50.0s		

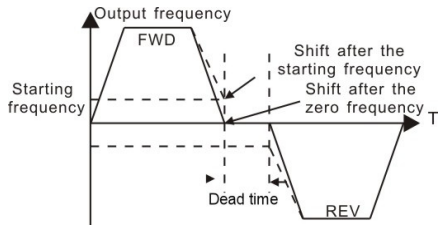
Function code	Name	Detailed instruction of parameters	Default value	Modify
P01.13	Dead time of FWD/REV rotation	<p>During the procedure of switching FWD/REV rotation, set the threshold by P01.14, which is as the table below:</p>  <p>Setting range: 0.0~3600.0s</p>	0.00s	○
P01.14	Switching between FWD/REV rotation	<p>Set the threshold point of the inverter:</p> <p>0:Switch after 0 frequency 1:Switch after the starting frequency 2:Switch after a delay time when the inverter stops</p>	0	◎
P01.15	Stopping speed	0.00~100.00Hz	1.00 Hz	◎
P01.18	Terminal Run protection when powering on	<p>When the run command is set to terminal control, the system will detect the state of the run terminal during powering on.</p> <p>0: The terminal run command is invalid when powering on. Even the running command is detected to be valid during powering on, the inverter won't run and the system keeps in the protection state until the running command is cancelled and re-enabled.</p> <p>1: The terminal run command is valid when powering on. If the run command is detected to be valid during powering on, the system will start the inverter automatically after the initialization.</p> <p>Note: this function should be selected with caution!!</p>	0	○
P01.19	The running frequency is lower than the lower limit one (valid if the lower limit frequency is above 0)	<p>This function code determines the running state of the inverter when the set frequency is lower than the lower-limit one.</p> <p>0: Run at the lower-limit frequency 1: Stop 2: Hibernation</p> <p>The inverter will coast to stop when the set frequency is lower than the lower-limit one.if the set frequency is above the lower limit one again and it lasts for the time set by P01.20, the inverter will return to the running state</p>	0	◎

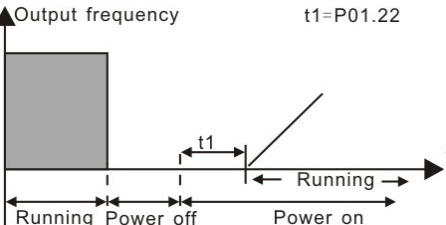
Function code	Name	Detailed instruction of parameters	Default value	Modify
		automatically.		
P01.20	Hibernation restore delay time	<p>Sets the hibernation delay time. When the running frequency of the inverter is lower than the lower limit one, the inverter will pause to stand by.</p> <p>When the set frequency is above the lower limit for longer than time set by P01.20, the inverter will run automatically.</p> <p>Note: The time is the total value when the set frequency is above the lower limit one.</p> <p>Setting range: 0.0~3600.0s (valid when P01.19=2)</p>	0.0s	○
P01.21	Restart after power off	<p>This function can enable the inverter start or not after the power off and then power on.</p> <p>0: Disabled</p> <p>1: Enabled, if the starting need is met, the inverter will run automatically after waiting for the time defined by P01.22.</p>	0	○
P01.22	Restart delay time after power off	<p>The function sets the delay time before the automatic running of the inverter after power up.</p>  <p>Setting range: 0.0~3600.0s (valid when P01.21=1)</p>	1.0s	○
P01.23	Start delay time	<p>The function determines the brake release after the running command is given, and the inverter is in a stand-by state and wait for the delay time set by P01.23</p> <p>Setting range: 0.0~60.0s</p>	0.0s	○
P01.24	Delay of the stopping speed	Setting range: 0.0~100.0 s	0.0s	○
P02 Group Motor 1				
P02.01	Asynchronous motor rated power	0.1~3000.0kW	Depend on model	◎

Function code	Name	Detailed instruction of parameters	Default value	Modify
P02.02	Asynchronous motor rated frequency	0.01Hz~P00.03 (the Max. frequency)	50.00Hz	☉
P02.03	Asynchronous motor rated speed	1~36000rpm	Depend on model	☉
P02.04	Asynchronous motor rated voltage	0~1200V	Depend on model	☉
P02.05	Asynchronous motor rated current	0.8~6000.0A	Depend on model	☉
P02.06	Asynchronous motor stator resistor	0.001~65.535Ω	Depend on model	○
P02.07	Asynchronous motor rotor resistor	0.001~65.535Ω	Depend on model	○
P02.08	Asynchronous motor leakage inductance	0.1~6553.5mH	Depend on model	○
P02.09	Asynchronous motor mutual inductance	0.1~6553.5mH	Depend on model	○
P02.10	Asynchronous motor non-load current	0.1~6553.5A	Depend on model	○
P02.26	Motor overload protection	0:No protection 1: Common motor (with low speed compensation). Because the heat-releasing effect of the common motors will be weakened, the corresponding electric heat	2	☉

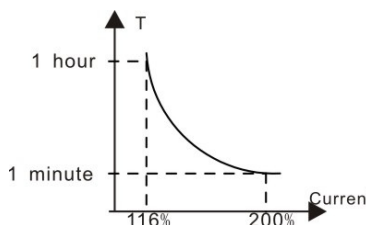
Function code	Name	Detailed instruction of parameters	Default value	Modify
		<p>protection will be adjusted properly. The low speed compensation characteristic mentioned here means reducing the threshold of the overload protection of the motor whose running frequency is below 30Hz.</p> <p>2: Frequency conversion motor (without low speed compensation) Because the heat-releasing effect of the specific motors won't be impacted by the rotation speed, it is not necessary to adjust the protection value during low-speed running.</p>		
P02.27	Motor overload protection coefficient	<p>When P02.27=overload protection current of the motor/rated current of the motor</p> <p>So, the bigger the overload coefficient is, the shorter the reporting time of the overload fault is. When the overload coefficient <110%, there is no overload protection. When the overload coefficient =116%, the fault will be reported after 1 hour, when the overload coefficient=200%, the fault will be reported after 1 minute.</p>  <p>Setting range: 20.0%~120.0%</p>	100.0%	○
P04 Group V/F control				
P04.00	Motor V/F curve setting	<p>DefineS the V/F curve of IMO XKL motor to meet the need of different loads.</p> <p>0: Straight line V/F curve; applying to the constant torque load</p> <p>1: Multi-dots V/F curve</p>	0	◎
P04.01	Torque boost	Torque boost to the output voltage for the features of low frequency torque. P04.01 is for the Max. Output voltage V_b .	0.0%	○
P04.02	Torque boost close	<p>P04.02 defines the percentage of closing frequency of manual torque to f_b.</p> <p>Torque boost should be selected according to the load. The larger the load is, the higher the torque is. Too high torque boost will create excessive magnetizing current,</p>	20.0%	○

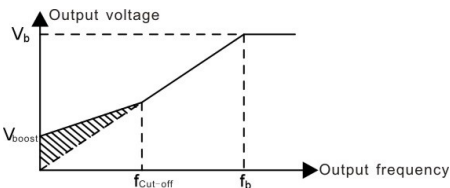
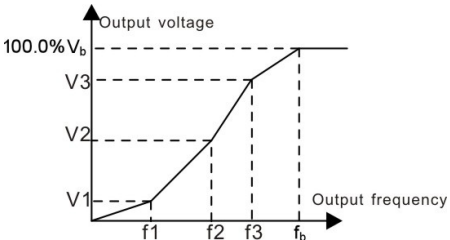
Function code	Name	Detailed instruction of parameters	Default value	Modify
		<p>and the current of the inverter will increase the temperature of the inverter and decrease the efficiency. When the torque boost is set to 0.0%, the inverter is automatic torque boost.</p> <p>Torque boost threshold: below this frequency point, the torque boost is valid, but over this frequency point, the torque boost is invalid.</p>  <p>The setting range of P04.01: 0.0%: (automatic) 0.1%~10.0% The setting range of P04.02:0.0%~50.0%</p>		
P04.03	Motor V/F frequency point 1	 <p>When P04.00 =1, the user can set V//F curve through P04.03~P04.08. V/F is generally set according to the load of the motor.</p> <p>Note: $V1 < V2 < V3, f1 < f2 < f3$. Too high or low frequency voltage can overheat the motor excessively or cause damage to the inverter.</p> <p>The setting range of P04.03: 0.00Hz~P04.05</p> <p>The setting range of P04.04, P04.06 and P04.08 : 0.0%~110.0%</p> <p>The setting range of P04.05:P04.03~ P04.07</p> <p>The setting range of P04.07:P04.05~P02.02 (the rated frequency of motor 1)</p>	0.00Hz	○
P04.04	Motor V/F voltage point 1		00.0%	○
P04.05	Motor V/F frequency point 2		00.00Hz	○
P04.06	Motor V/F voltage point 2		00.0%	○
P04.07	Motor V/F frequency point 3		00.00Hz	○
P04.08	Motor V/F voltage point 3		00.0%	○

Function code	Name	Detailed instruction of parameters	Default value	Modify
P04.09	Motor V/F slip compensation gain	<p>This function code is used to compensate the change of the rotation speed caused by load during running and improve the stability of the motor. It can be set to the rated slip frequency of the motor which is calculated as below:</p> $\Delta f = f_b - n \cdot p / 60$ <p>Of which, f_b is the rated frequency of the motor, its function code is P02.01; n is the rated rotating speed of the motor and its function code is P02.02; p is the pole pair of the motor. 100.0% corresponds to the rated slip frequency Δf.</p> <p>Note: no torque compensation for single-phase 220V inverters</p> <p>Setting range:0.0~200.0%</p>	380V: 100.0%	○
			220V:0%	
P04.10	Low frequency vibration control factor	In the V/F control mode, current fluctuation may occur to the motor on some frequency, especially larger kW motors.. The motor runs unstable or overcurrent may occur. This can be overcome by adjusting this parameter.	10	○
P04.11	High frequency vibration control factor	The setting range of P04.10: 0~100 The setting range of P04.11: 0~100	10	○
P04.12	Vibration control threshold	The setting range of P04.12:0.00Hz~P00.03(the Max. frequency)	30.00 Hz	○
P04.26	Energy-saving operation	0: No operation 1: Automatic energy-saving The motor adjusts the output voltage in non-load state automatically.	0	◎
P05 Group Input terminals				
P05.01	S1 terminals function selection	0: No function 1: Forward rotation operation 2: Reverse rotation operation	1	◎
P05.02	S2 terminals function selection	3: 3-wire control operation 4: Forward rotation jogging 5: Reverse rotation jogging	4	◎

Function code	Name	Detailed instruction of parameters	Default value	Modify
P05.03	S3 terminals function selection	6: Coast to stop 7: Fault reset 8: Operation pause	7	⊙
P05.04	S4 terminals function selection	9: External fault input 10:Increasing frequency setting(UP) 11:Decreasing frequency setting(DOWN) 12:Cancel the frequency change setting	0	⊙
P05.05	S5 terminals function selection	13:Shift between A setting and B setting 14:Shift between combination setting and A setting 15:Shift between combination setting and B setting 16:Multi-stage speed terminal 1 17:Multi-stage speed terminal 2 18:Multi-stage speed terminal 3 19:Multi- stage speed terminal 4 20:Multi- stage speed pause 21:ACC/DEC time option 1 25:PID control pause 26:Traverse Pause(stop at the current frequency) 27:Traverse reset(return to the center frequency) 28:Counter reset 30:ACC/DEC prohibition 31:Counter trigger 33:Cancel the frequency change setting temporarily 34:DC brake 36:Shift the command to the keypad 37:Shift the command to the terminals 38:Shift the command to the communication	0	⊙

Function code	Name	Detailed instruction of parameters	Default value	Modify																																																																																																																																																																																																						
P05.10	Polarity selection of the input terminals	<p>The function code sets the polarity of the input terminals. Set Value according to normal/inverse switching requirements. Normal = <input type="checkbox"/> Inverse = <input type="checkbox"/></p> <table border="1"> <thead> <tr> <th>Value</th> <th>S5</th> <th>S4</th> <th>S3</th> <th>S2</th> <th>S1</th> </tr> </thead> <tbody> <tr><td>0</td><td></td><td></td><td></td><td></td><td></td></tr> <tr><td>1</td><td></td><td></td><td></td><td></td><td style="background-color: #cccccc;"></td></tr> <tr><td>2</td><td></td><td></td><td></td><td style="background-color: #cccccc;"></td><td></td></tr> <tr><td>3</td><td></td><td></td><td></td><td style="background-color: #cccccc;"></td><td style="background-color: #cccccc;"></td></tr> <tr><td>4</td><td></td><td></td><td style="background-color: #cccccc;"></td><td></td><td></td></tr> <tr><td>5</td><td></td><td></td><td style="background-color: #cccccc;"></td><td></td><td style="background-color: #cccccc;"></td></tr> <tr><td>6</td><td></td><td></td><td style="background-color: #cccccc;"></td><td style="background-color: #cccccc;"></td><td></td></tr> <tr><td>7</td><td></td><td></td><td style="background-color: #cccccc;"></td><td style="background-color: #cccccc;"></td><td style="background-color: #cccccc;"></td></tr> <tr><td>8</td><td></td><td style="background-color: #cccccc;"></td><td></td><td></td><td></td></tr> <tr><td>9</td><td></td><td style="background-color: #cccccc;"></td><td></td><td></td><td style="background-color: #cccccc;"></td></tr> <tr><td>A</td><td></td><td style="background-color: #cccccc;"></td><td></td><td style="background-color: #cccccc;"></td><td></td></tr> <tr><td>B</td><td></td><td style="background-color: #cccccc;"></td><td></td><td style="background-color: #cccccc;"></td><td style="background-color: #cccccc;"></td></tr> <tr><td>C</td><td></td><td style="background-color: #cccccc;"></td><td style="background-color: #cccccc;"></td><td></td><td></td></tr> <tr><td>D</td><td></td><td style="background-color: #cccccc;"></td><td style="background-color: #cccccc;"></td><td></td><td style="background-color: #cccccc;"></td></tr> <tr><td>E</td><td></td><td style="background-color: #cccccc;"></td><td style="background-color: #cccccc;"></td><td style="background-color: #cccccc;"></td><td></td></tr> <tr><td>F</td><td></td><td style="background-color: #cccccc;"></td><td style="background-color: #cccccc;"></td><td style="background-color: #cccccc;"></td><td style="background-color: #cccccc;"></td></tr> <tr><td>10</td><td style="background-color: #cccccc;"></td><td></td><td></td><td></td><td></td></tr> <tr><td>11</td><td style="background-color: #cccccc;"></td><td></td><td></td><td></td><td style="background-color: #cccccc;"></td></tr> <tr><td>12</td><td style="background-color: #cccccc;"></td><td></td><td></td><td style="background-color: #cccccc;"></td><td></td></tr> <tr><td>13</td><td style="background-color: #cccccc;"></td><td></td><td></td><td style="background-color: #cccccc;"></td><td style="background-color: #cccccc;"></td></tr> <tr><td>14</td><td style="background-color: #cccccc;"></td><td></td><td style="background-color: #cccccc;"></td><td></td><td></td></tr> <tr><td>15</td><td style="background-color: #cccccc;"></td><td></td><td style="background-color: #cccccc;"></td><td></td><td style="background-color: #cccccc;"></td></tr> <tr><td>16</td><td style="background-color: #cccccc;"></td><td></td><td style="background-color: #cccccc;"></td><td style="background-color: #cccccc;"></td><td></td></tr> <tr><td>17</td><td style="background-color: #cccccc;"></td><td></td><td style="background-color: #cccccc;"></td><td style="background-color: #cccccc;"></td><td style="background-color: #cccccc;"></td></tr> <tr><td>18</td><td style="background-color: #cccccc;"></td><td style="background-color: #cccccc;"></td><td></td><td></td><td></td></tr> <tr><td>19</td><td style="background-color: #cccccc;"></td><td style="background-color: #cccccc;"></td><td></td><td></td><td style="background-color: #cccccc;"></td></tr> <tr><td>1A</td><td style="background-color: #cccccc;"></td><td style="background-color: #cccccc;"></td><td></td><td style="background-color: #cccccc;"></td><td></td></tr> <tr><td>1B</td><td style="background-color: #cccccc;"></td><td style="background-color: #cccccc;"></td><td></td><td style="background-color: #cccccc;"></td><td style="background-color: #cccccc;"></td></tr> <tr><td>1C</td><td style="background-color: #cccccc;"></td><td style="background-color: #cccccc;"></td><td style="background-color: #cccccc;"></td><td></td><td></td></tr> <tr><td>1D</td><td style="background-color: #cccccc;"></td><td style="background-color: #cccccc;"></td><td style="background-color: #cccccc;"></td><td></td><td style="background-color: #cccccc;"></td></tr> <tr><td>1E</td><td style="background-color: #cccccc;"></td><td style="background-color: #cccccc;"></td><td style="background-color: #cccccc;"></td><td style="background-color: #cccccc;"></td><td></td></tr> <tr><td>1F</td><td style="background-color: #cccccc;"></td><td style="background-color: #cccccc;"></td><td style="background-color: #cccccc;"></td><td style="background-color: #cccccc;"></td><td style="background-color: #cccccc;"></td></tr> </tbody> </table>	Value	S5	S4	S3	S2	S1	0						1						2						3						4						5						6						7						8						9						A						B						C						D						E						F						10						11						12						13						14						15						16						17						18						19						1A						1B						1C						1D						1E						1F						0x000	○
Value	S5	S4	S3	S2	S1																																																																																																																																																																																																					
0																																																																																																																																																																																																										
1																																																																																																																																																																																																										
2																																																																																																																																																																																																										
3																																																																																																																																																																																																										
4																																																																																																																																																																																																										
5																																																																																																																																																																																																										
6																																																																																																																																																																																																										
7																																																																																																																																																																																																										
8																																																																																																																																																																																																										
9																																																																																																																																																																																																										
A																																																																																																																																																																																																										
B																																																																																																																																																																																																										
C																																																																																																																																																																																																										
D																																																																																																																																																																																																										
E																																																																																																																																																																																																										
F																																																																																																																																																																																																										
10																																																																																																																																																																																																										
11																																																																																																																																																																																																										
12																																																																																																																																																																																																										
13																																																																																																																																																																																																										
14																																																																																																																																																																																																										
15																																																																																																																																																																																																										
16																																																																																																																																																																																																										
17																																																																																																																																																																																																										
18																																																																																																																																																																																																										
19																																																																																																																																																																																																										
1A																																																																																																																																																																																																										
1B																																																																																																																																																																																																										
1C																																																																																																																																																																																																										
1D																																																																																																																																																																																																										
1E																																																																																																																																																																																																										
1F																																																																																																																																																																																																										
P05.11	Switch filter time	<p>Set the sample filter time of S1~S5 and HDI terminals. If the interference is strong, increase the parameter to avoid the disoperation. 0.000~1.000s</p>	0.010s	○																																																																																																																																																																																																						

Function code	Name	Detailed instruction of parameters	Default value	Modify
P05.12	Virtual terminals setting	Enable the input function of virtual terminals at the communication mode. 0:Virtual terminals is invalid 1:MODBUS communication virtual terminals are valid	0	⊙
P05.13	Terminals control running mode	Set the operation mode of the terminals control 0:2-wire control 1, comply the enable with the direction. This mode is widely used. It determines the rotation direction by the defined FWD and REV terminals command. 1:2-wire control 2: Separate the enable from the direction. FWD defined by this mode is the enabling ones. The direction depends on the state of the defined REV. 2:3-wire control 1; Sin is the enabling terminal in this mode, and the running command is caused by FWD and the direction is controlled by REV. Sin is natural closed. 3:3-wire control 2; Sin is the enabling terminal on this mode, if set Si (i=1~5) to 3, when K is switched on, the control of FWD and REV is valid; when K is switched off, the control of FWD and REV is invalid. The inverter stops. Note: for the 2-wire running mode, when FWD/REV terminal is valid, the inverter stop because of the stopping command from other sources, even the control terminal FWD/REV keeps valid; the inverter won't work when the stopping command is canceled. Only when FWD/REV is relaunched, the inverter can start again.	0	⊙

P05.14 S1 terminal switching on delay time

The function code defines the corresponding delay time of electrical level of the programmable terminals from switching on to switching off.

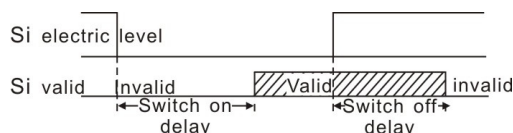

ERROR: stackunderflow
OFFENDING COMMAND: ~

STACK:

X-ON Electronics

Largest Supplier of Electrical and Electronic Components

Click to view similar products for imo manufacturer:

Other Similar products are found below :

[20.155MV/12-E](#) [MC14N-S-10110AC](#) [MB09-S-10=24](#) [DPS-1-030-24](#) [SRF-1C-SL-12VDC](#) [MB09-S-1024](#) [LDC18RRS](#) [SFSYE0111](#)
[21.1500M/6-E](#) [20.3304M/2-E](#) [21.910M/5-E](#) [20.95MA/2-E](#) [21.95MHF/2-E](#) [PE69-4032](#) [DPS-1-060-24](#) [CS20A-A2](#) [CS20A-U1](#) [VFC02](#)
[MSSTC11DA06](#) [20.95MHF/3-E](#) [B3T10](#) [XKL-040-21](#) [20.3304M/4-E](#) [SRDH-1A-SL-24VDC](#) [20.2500M/5-E](#) [21.155MH/12](#) [SRRHN-2CN-](#)
[SL-12VDC](#) [20.920M/5-E](#) [MC10N-S-10110AC](#) [21.1550MF/8-E](#) [20.910M/6-E](#) [20.95MH/3-E](#) [21.95MV/3](#) [MA05-S-01230AC](#) [SRRHN-2CN-](#)
[SL-5VDC](#) [LB69-4040](#) [20.3001M/6](#) [21.1500M/3-E](#) [SFSYE0311](#) [21.95MHF/6-E](#) [20.95MV/2-E](#) [20.155MV/4-E](#) [20.155MH/4-E](#) [20.950M/2-E](#)
[MT5 1-50-FAR](#) [BS3P3REDO](#) [MB12-S-10=24](#) [MA05-S-1024DC](#) [20.155MVF/8-E](#) [20.2500MV/8-E](#)