

Engineer Drawing

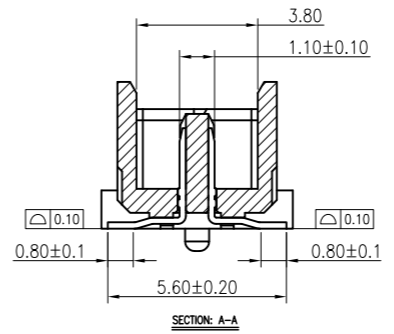
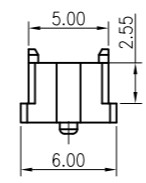
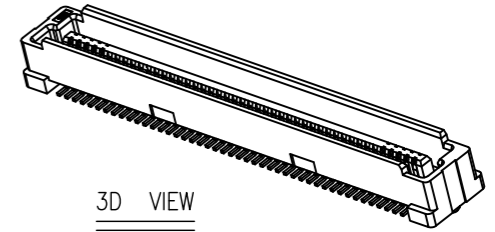
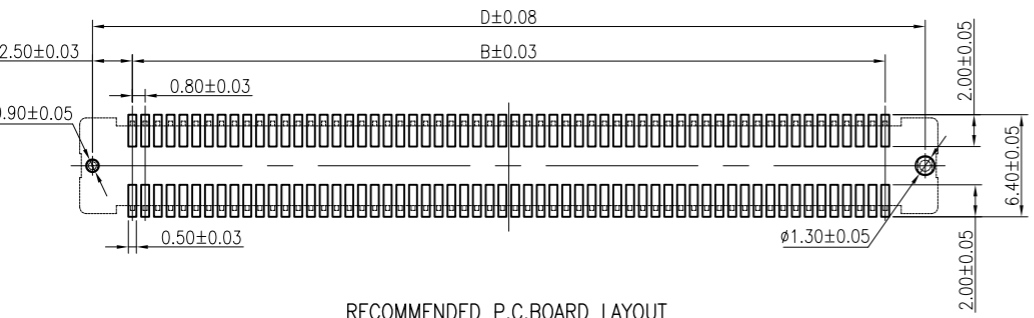
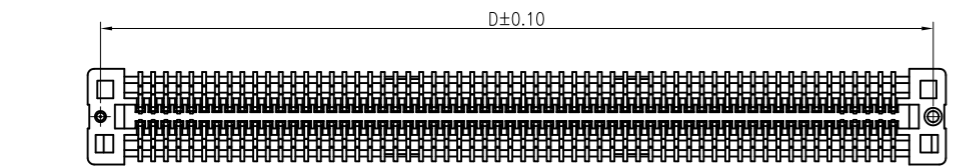
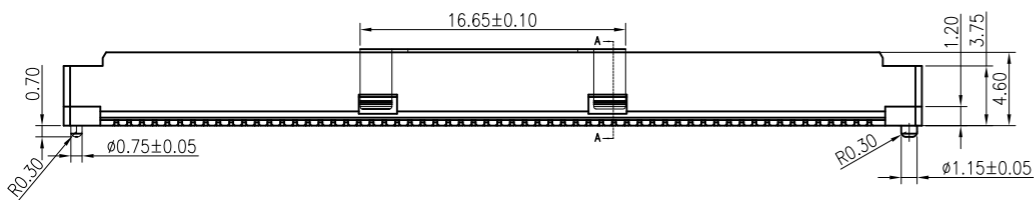
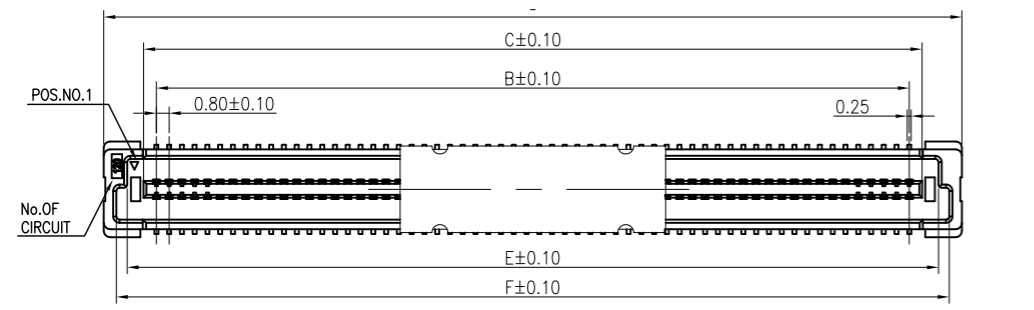

NOTES:

- 1.HUOSING: LCP HIGH-TEMP THERMOPLASTIC UL94V-0 COLOR:BEIGE
- 2.TERMINAL:PHOSPHOR BRONZE

IPC8 08 471 M XX X X X

① ② ③ ④ ⑤ ⑥ ⑦ ⑧

- ① Series Type
- ② Pitch:0.8mm
- ③ Height
- ④ Connector Type
- ⑤ Pin Code
- ⑥ Rows Code
- ⑦ Serial Code
- ⑧ Other Code

NO.of contacts	Dimensions					
	A	B	C	D	E	F
40	21.80	15.20	16.80	20.20	18.86	20.21
50	25.80	19.20	20.80	24.20	22.86	24.21
60	29.80	23.20	24.80	28.20	26.86	28.21
80	37.80	31.20	32.80	36.20	34.86	36.21
100	45.80	39.20	40.80	44.20	42.86	44.21
120	53.80	47.20	48.80	52.20	50.86	52.21
140	61.80	55.20	46.80	60.20	58.86	60.21
160	69.80	63.20	64.80	68.20	66.86	68.21
180	77.80	71.20	72.80	76.20	74.86	76.21
200	85.80	79.20	80.80	84.20	82.86	84.21

<p>TOLERANCES: X: =±0.25 X.X: =±0.20 X.XX: =±0.10 GENERAL ANGLE X° = ±1°</p>		www.i-ncp.com	
	PART NO: IPC808471M xxS7V	NAME: 0.8PH H4.7 BTB Male Receptacle Assembly H5.0	
	DRAWING NO IPC808471M07V		
	SHEET 1 OF 1	UNITS:mm	SCALE:1:1

X-ON Electronics

Largest Supplier of Electrical and Electronic Components

Click to view similar products for [Board to Board & Mezzanine Connectors](#) category:

Click to view products by [INCP](#) manufacturer:

Other Similar products are found below :

[589158040000018](#) [MDF7C-18P-2.54DSA\(55\)](#) [FCN-268F036-G/BD](#) [FCN-268M012-G/0D](#) [FCN-268M024-G/1D](#) [MIS-048-01-F-D-DP-K](#)
[832-10-034-10-001000](#) [FX4C-80S-1.27DSA](#) [93696-330](#) [224393](#) [FCN-235D050-G/C](#) [210-93-314-41-105000](#) [MDF7-40DP-2.54DSA\(55\)](#)
[55323-1519](#) [069159702701000](#) [101A10019X](#) [105061100000861+](#) [75140-7012](#) [87471-650](#) [1744382-4](#) [063209](#) [10124054-515LF](#) [68685-603](#)
[8-1616154-3](#) [541371078](#) [IL-WX-10PB-HF-B-E1000E](#) [FX23-40P-0.5SV15B](#) [FCN-214J100-G/0](#) [354184](#) [P50-028-DDS-TG](#) [53309-2471](#)
[54546-2071](#) [1586617-1](#) [504248-1210](#) [504248-2010](#) [1-1437355-2](#) [9159005551906](#) [NDS100-004-BF](#) [93696-730LF](#) [91922-31141LF](#) [505274-](#)
[3440](#) [501493-2410](#) [504208-3410](#) [505006-0811](#) [505274-2040](#) [202436-1600](#) [202477-0414](#) [71660-7580](#) [73420-5192](#) [360-10-107-00-001000](#)