

2.00mm Pitch Wire To Board Connector

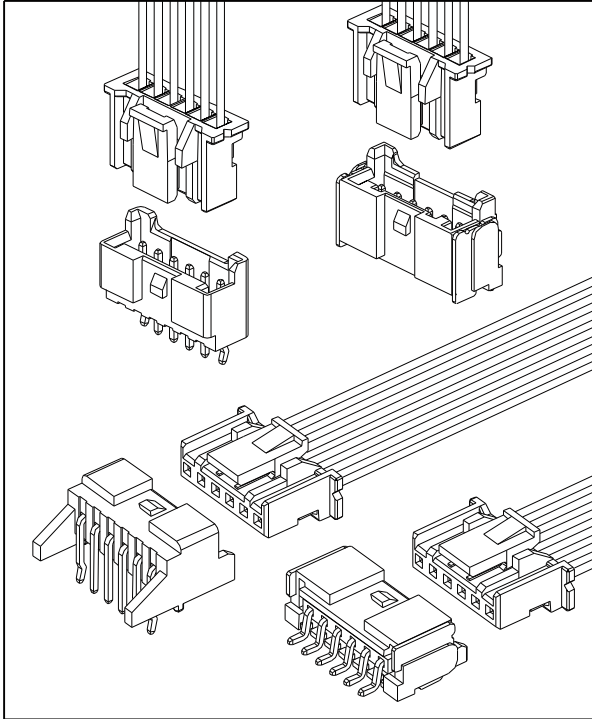

Specification

| | |
|----------------------------|----------------|
| Circuits | 02 - 16 |
| Pitch | 2.00mm |
| Current Rating | 3A AC/DC |
| Voltage Rating | 250V AC/DC |
| Contact Resistance | 20mΩ MAX. |
| Withstand Voltage | 800V AC/minute |
| Insulation Resistance | 1,000MΩ MIN. |
| Temperature Range | -25°C - +105°C |
| Applicable Wire Range | AWG #22 - #28 |
| Applicable P.C.B Thickness | 1.6mm |
| Applicable P.C.B Hole Dia. | Ø0.8mm ± 0.05 |

Assembly Layout

Right Angle Type

DIP-Type

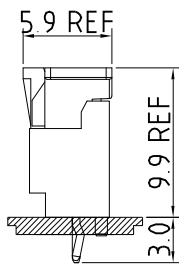

SMT-Type

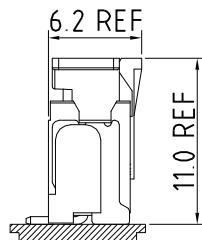

Vertical Type

DIP-Type

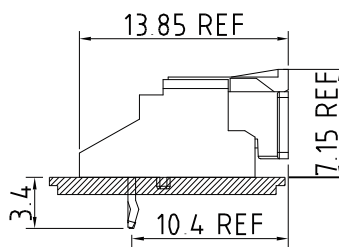

SMT-Type

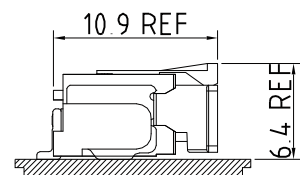

IPCW211 * ** * * * * *
 ① ② ③ ④ ⑤ ⑥ ⑦ ⑧

① Series Type. IPCW211

④ Material code.

⑧ Other code.

② Connector Type.

⑤ Appearance code.

Wafer

T: Terminal

V: Vertical Type

W: Wafer

R: Right Angle

H: Housing

⑥ Internal code

S: Vertical SMT TYPE (02 - 08)

③ Pin code.

⑦ Company code.

T: Vertical SMT TYPE (09 - 16)

Row

M: Right Angle SMT TYPE

Pin number of row

Unit : mm

Housing

Features

Available Number of Circuits : 02 - 16

Material : Regular Thermoplastic 94V-0

Use with : IPCW211 Crimp Terminal

Mates with : IPCW211 Series Wafer

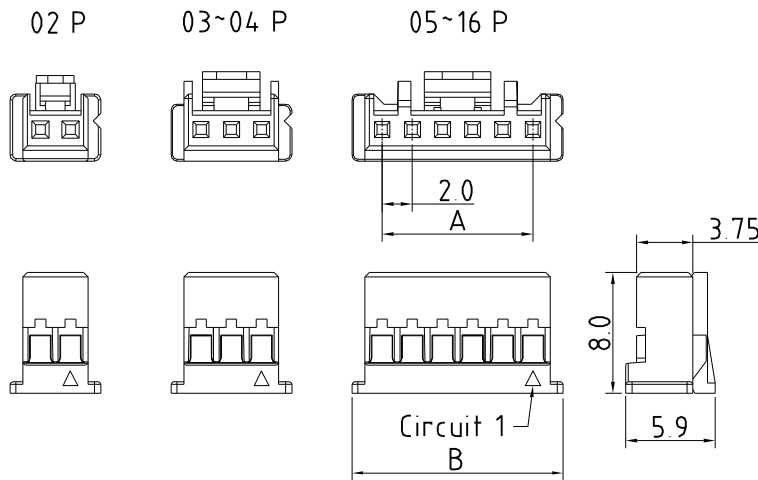

Dimension and Order Information

| Circuits | Part No. | DIM.(mm) | |
|----------|-------------|----------|-------|
| | | A | B |
| 2 | IPCW211W12* | 2.00 | 6.00 |
| 3 | IPCW211H13* | 4.00 | 8.00 |
| 4 | IPCW211H14* | 6.00 | 10.00 |
| 5 | IPCW211H15* | 8.00 | 12.00 |
| 6 | IPCW211H16* | 10.00 | 14.00 |
| 7 | IPCW211H17* | 12.00 | 16.00 |
| 8 | IPCW211H18* | 14.00 | 18.00 |
| 9 | IPCW211H19* | 16.00 | 20.00 |
| 10 | IPCW211H1A* | 18.00 | 22.00 |
| 11 | IPCW211H1B* | 20.00 | 24.00 |
| 12 | IPCW211H1C* | 22.00 | 26.00 |
| 13 | IPCW211H1D* | 24.00 | 28.00 |
| 14 | IPCW211H1E* | 26.00 | 30.00 |
| 15 | IPCW211H1F* | 28.00 | 32.00 |
| 16 | IPCW211H1G* | 30.00 | 34.00 |

Wafer

Vertical

Features

Available Number of Circuits : 02 - 16

Material : Regular Thermoplastic 94V-0

Contact : 0.5mm(.020") Copper Alloy, Tin-plated

Mates with : IPCW211 Series Housing

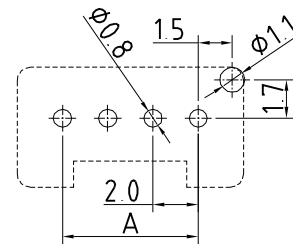
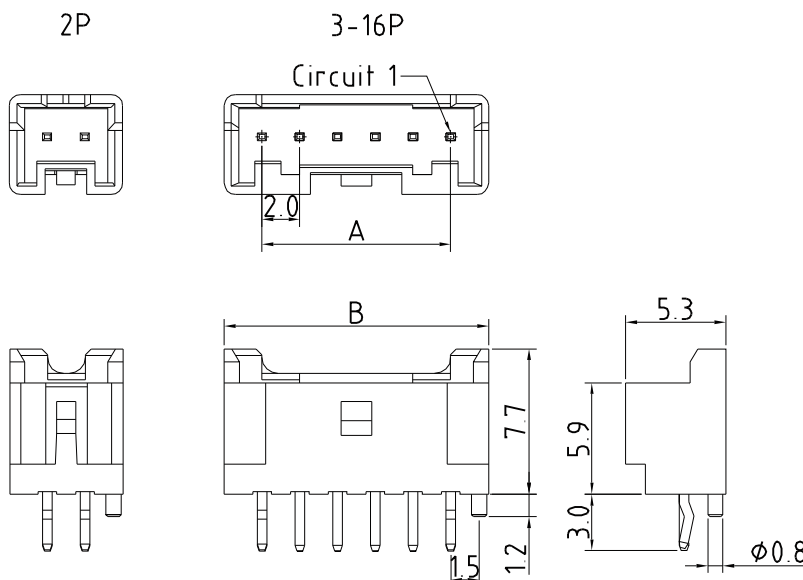

P.C.B LAYOUT

Dimension and Order Information

| Circuits | Part No. | DIM.(mm) | |
|----------|--------------|----------|-------|
| | | A | B |
| 2 | IPCW211W12*V | 2.00 | 6.00 |
| 3 | IPCW211W13*V | 4.00 | 8.00 |
| 4 | IPCW211W14*V | 6.00 | 10.00 |
| 5 | IPCW211W15*V | 8.00 | 12.00 |
| 6 | IPCW211W16*V | 10.00 | 14.00 |
| 7 | IPCW211W17*V | 12.00 | 16.00 |
| 8 | IPCW211W18*V | 14.00 | 18.00 |
| 9 | IPCW211W19*V | 16.00 | 20.00 |
| 10 | IPCW211W1A*V | 18.00 | 22.00 |
| 11 | IPCW211W1B*V | 20.00 | 24.00 |
| 12 | IPCW211W1C*V | 22.00 | 26.00 |
| 13 | IPCW211W1D*V | 24.00 | 28.00 |
| 14 | IPCW211W1E*V | 26.00 | 30.00 |
| 15 | IPCW211W1F*V | 28.00 | 32.00 |
| 16 | IPCW211W1G*V | 30.00 | 34.00 |

2.00mm Pitch Wire To Board Connector

Wafer

Right Angle

Features

Available Number of Circuits : 02 - 16

Material : Regular Thermoplastic 94V-0

Contact : 0.5mm(.020") Copper Alloy, Tin-plated

Mates with : IPCW211 Series Housing

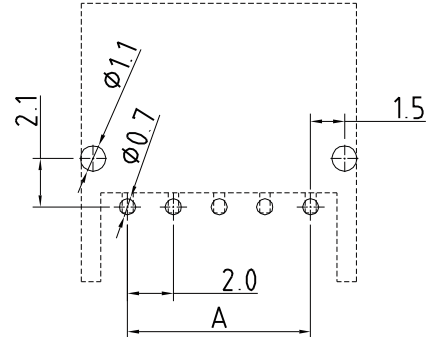
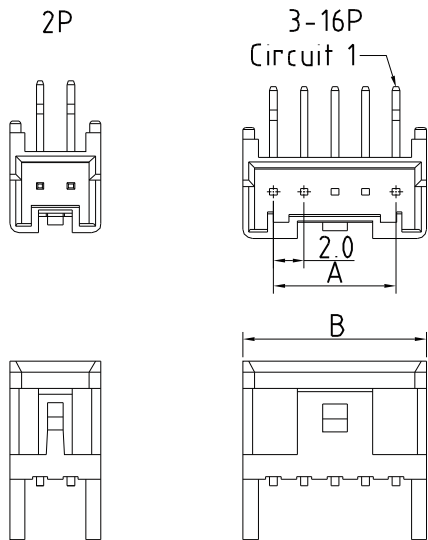

P.C.B LAYOUT

Dimension and Order Information

| Circuits | Part No. | DIM.(mm) | |
|----------|--------------|----------|-------|
| | | A | B |
| 2 | IPCW211W12*R | 2.00 | 5.96 |
| 3 | IPCW211W13*R | 4.00 | 7.96 |
| 4 | IPCW211W14*R | 6.00 | 9.96 |
| 5 | IPCW211W15*R | 8.00 | 11.96 |
| 6 | IPCW211W16*R | 10.00 | 13.96 |
| 7 | IPCW211W17*R | 12.00 | 15.96 |
| 8 | IPCW211W18*R | 14.00 | 17.96 |
| 9 | IPCW211W19*R | 16.00 | 19.96 |
| 10 | IPCW211W1A*R | 18.00 | 21.96 |
| 11 | IPCW211W1B*R | 20.00 | 23.96 |
| 12 | IPCW211W1C*R | 22.00 | 25.96 |
| 13 | IPCW211W1D*R | 24.00 | 27.96 |
| 14 | IPCW211W1E*R | 26.00 | 29.96 |
| 15 | IPCW211W1F*R | 28.00 | 31.96 |
| 16 | IPCW211W1G*R | 30.00 | 33.96 |

Wafer

Vertical SMT Type

Features

Available Number of Circuits : 02 - 15

Material : High Temperature Thermoplastic 94V-0

Contact: 0.5mm(.020") Copper Alloy, Matte-Tin

Mates with : IPCW211 Series Housing

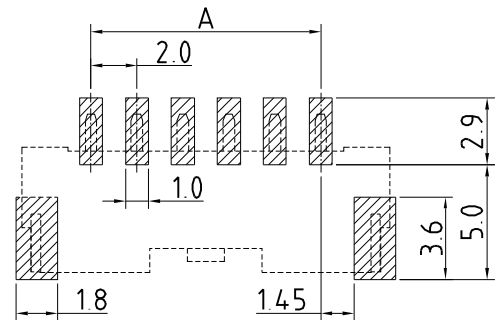
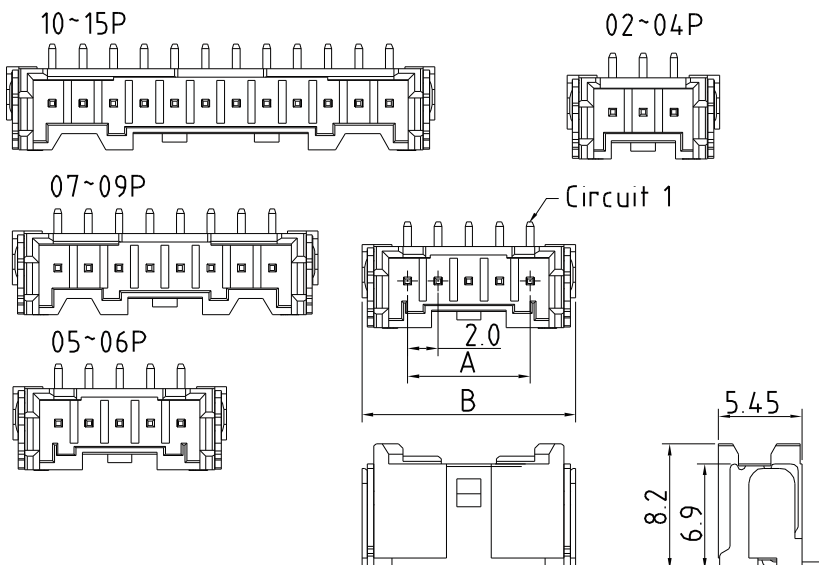

P.C.B LAYOUT

Dimension and Order Information

| Circuits | Part No. | DIM.(mm) | |
|----------|--------------|----------|-------|
| | | A | B |
| 2 | IPCW211W12*S | 2.00 | 8.00 |
| 3 | IPCW211W13*S | 4.00 | 10.00 |
| 4 | IPCW211W14*S | 6.00 | 12.00 |
| 5 | IPCW211W15*S | 8.00 | 14.00 |
| 6 | IPCW211W16*S | 10.00 | 16.00 |
| 7 | IPCW211W17*S | 12.00 | 18.00 |
| 8 | IPCW211W18*S | 14.00 | 20.00 |
| 9 | IPCW211W19*S | 16.00 | 22.00 |
| 10 | IPCW211W1A*S | 18.00 | 24.00 |
| 11 | IPCW211W1B*S | 20.00 | 26.00 |
| 12 | IPCW211W1C*S | 22.00 | 28.00 |
| 13 | IPCW211W1D*S | 24.00 | 30.00 |
| 14 | IPCW211W1E*S | 26.00 | 32.00 |
| 15 | IPCW211W1F*S | 28.00 | 34.00 |

2.00mm Pitch Wire To Board Connector

Wafer

Vertical SMT Post Type

Features

Available Number of Circuits : 02 - 15

Material : High Temperature Thermoplastic 94V-0

Contact : 0.5mm(.020") Copper Alloy, Matte-Tin

Mates with : IPCW211 Series Housing

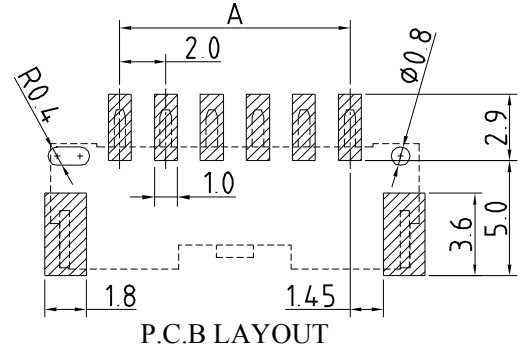
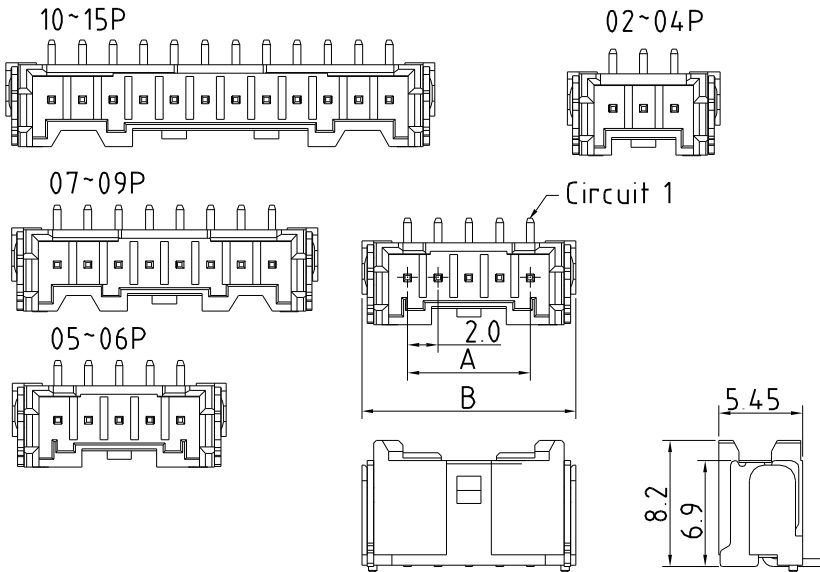

Dimension and Order Information

| Circuits | Part No. | DIM.(mm) | |
|----------|--------------|----------|-------|
| | | A | B |
| 2 | IPCW211W12*P | 2.00 | 8.00 |
| 3 | IPCW211W13*P | 4.00 | 10.00 |
| 4 | IPCW211W14*P | 6.00 | 12.00 |
| 5 | IPCW211W15*P | 8.00 | 14.00 |
| 6 | IPCW211W16*P | 10.00 | 16.00 |
| 7 | IPCW211W17*P | 12.00 | 18.00 |
| 8 | IPCW211W18*P | 14.00 | 20.00 |
| 9 | IPCW211W19*P | 16.00 | 22.00 |
| 10 | IPCW211W1A*P | 18.00 | 24.00 |
| 11 | IPCW211W1B*P | 20.00 | 26.00 |
| 12 | IPCW211W1C*P | 22.00 | 28.00 |
| 13 | IPCW211W1D*P | 24.00 | 30.00 |
| 14 | IPCW211W1E*P | 26.00 | 32.00 |
| 15 | IPCW211W1F*P | 28.00 | 34.00 |

Wafer

Vertical SMT B Type

Features

Available Number of Circuits : 02 - 15

Material : High Temperature Thermoplastic 94V-0

Contact : 0.5mm(.020") Copper Alloy, Matte-Tin

Mates with : IPCW211 Series Housing

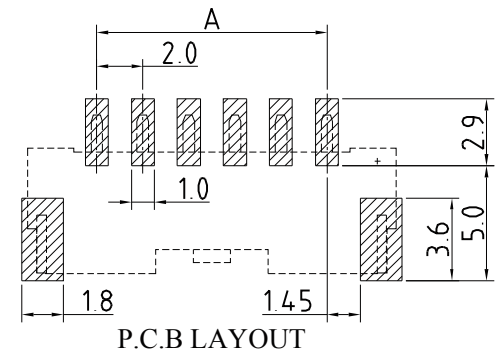
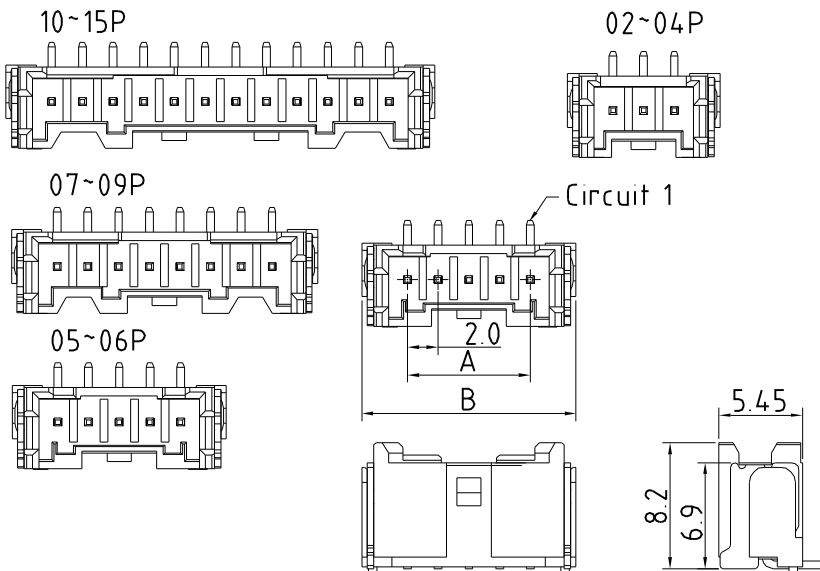

Dimension and Order Information

| Circuits | Part No. | DIM.(mm) | |
|----------|--------------|----------|-------|
| | | A | B |
| 2 | IPCW211W12*B | 2.00 | 8.00 |
| 3 | IPCW211W13*B | 4.00 | 10.00 |
| 4 | IPCW211W14*B | 6.00 | 12.00 |
| 5 | IPCW211W15*B | 8.00 | 14.00 |
| 6 | IPCW211W16*B | 10.00 | 16.00 |
| 7 | IPCW211W17*B | 12.00 | 18.00 |
| 8 | IPCW211W18*B | 14.00 | 20.00 |
| 9 | IPCW211W19*B | 16.00 | 22.00 |
| 10 | IPCW211W1A*B | 18.00 | 24.00 |
| 11 | IPCW211W1B*B | 20.00 | 26.00 |
| 12 | IPCW211W1C*B | 22.00 | 28.00 |
| 13 | IPCW211W1D*B | 24.00 | 30.00 |
| 14 | IPCW211W1E*B | 26.00 | 32.00 |
| 15 | IPCW211W1F*B | 28.00 | 34.00 |

2.00mm Pitch Wire To Board Connector

Wafer

Right Angle SMT Type

Unit : mm

Features

Available Number of Circuits : 02 - 15

Material : High Temperature Thermoplastic 94V-0

Contact: 0.5mm(.020") Copper Alloy, Matte-Tin

Mates with : IPCW211 Series Housing

02~04P

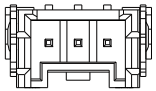

05~06P

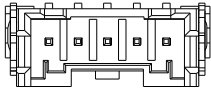
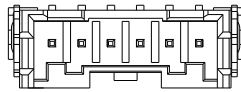

07

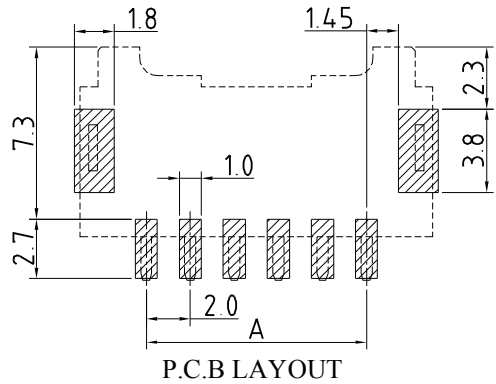
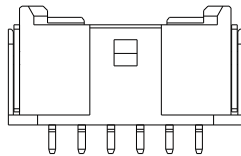
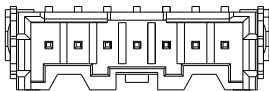

Dimension and Order Information

| Circuits | Part No. | DIM.(mm) | |
|----------|--------------|----------|-------|
| | | A | B |
| 2 | IPCW211W12*A | 2.00 | 8.00 |
| 3 | IPCW211W13*A | 4.00 | 10.00 |
| 4 | IPCW211W14*A | 6.00 | 12.00 |
| 5 | IPCW211W15*A | 8.00 | 14.00 |
| 6 | IPCW211W16*A | 10.00 | 16.00 |
| 7 | IPCW211W17*A | 12.00 | 18.00 |

Wafer

Right Angle SMT Type

Features

Available Number of Circuits :

Material : High Temperature Thermoplastic 94V-0

Contact: 0.5mm(.020") Copper Alloy, Matte-Tin

Mates with : IPCW211 Series Housing

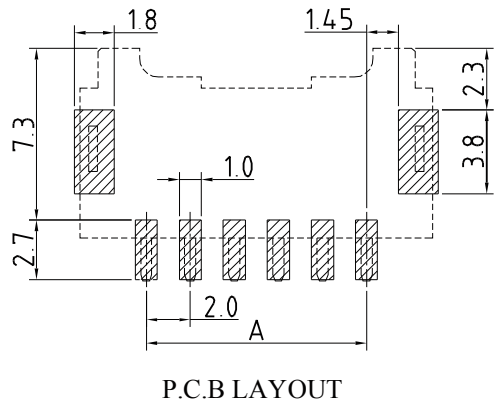
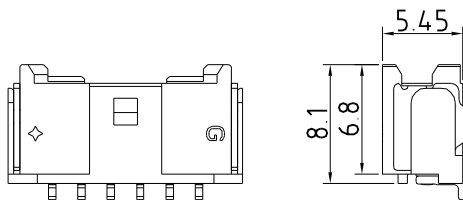
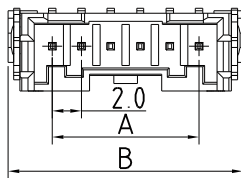

Dimension and Order Information

| Circuits | Part No. | DIM.(mm) | |
|----------|--------------|----------|-------|
| | | A | B |
| 8 | IPCW211W18*M | 14.00 | 20.00 |
| 9 | IPCW211W19*M | 16.00 | 22.00 |
| 10 | IPCW211W1A*M | 18.00 | 24.00 |
| 11 | IPCW211W1B*M | 20.00 | 26.00 |
| 12 | IPCW211W1C*M | 22.00 | 28.00 |
| 13 | IPCW211W1D*M | 24.00 | 30.00 |
| 14 | IPCW211W1E*M | 26.00 | 32.00 |
| 15 | IPCW211W1F*M | 28.00 | 34.00 |

2.00mm Pitch Wire To Board Connector

Unit : mm

Wafer

Right Angle SMT Post Type

Features

Available Number of Circuits : 02 - 15

Material : High Temperature Thermoplastic 94V-0

Contact: 0.5mm(.020") Copper Alloy, Matte-Tin

Mates with : IPCW211 Series Housing

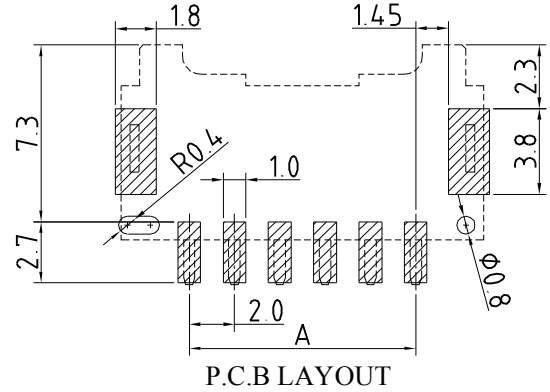
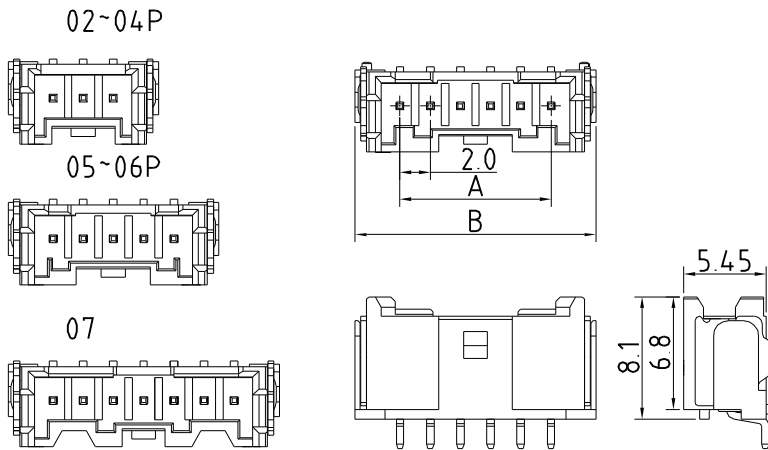

Dimension and Order Information

| Circuits | Part No. | DIM.(mm) | |
|----------|--------------|----------|-------|
| | | A | B |
| 2 | IPCW211W12*E | 2.00 | 8.00 |
| 3 | IPCW211W13*E | 4.00 | 10.00 |
| 4 | IPCW211W14*E | 6.00 | 12.00 |
| 5 | IPCW211W15*E | 8.00 | 14.00 |
| 6 | IPCW211W16*E | 10.00 | 16.00 |
| 7 | IPCW211W17*E | 12.00 | 18.00 |

Wafer

Right Angle SMT Post Type

Features

Available Number of Circuits : 02 - 15

Material : High Temperature Thermoplastic 94V-0

Contact: 0.5mm(.020") Copper Alloy, Matte-Tin

Mates with : IPCW211 Series Housing

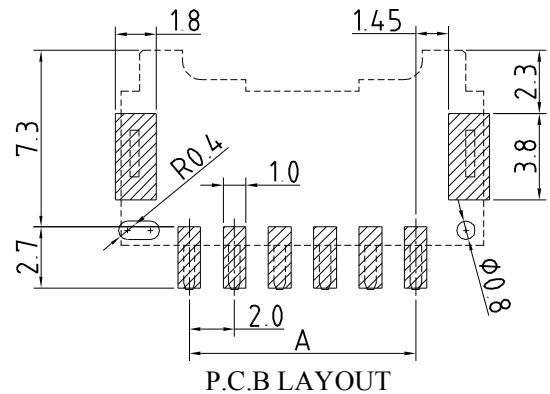
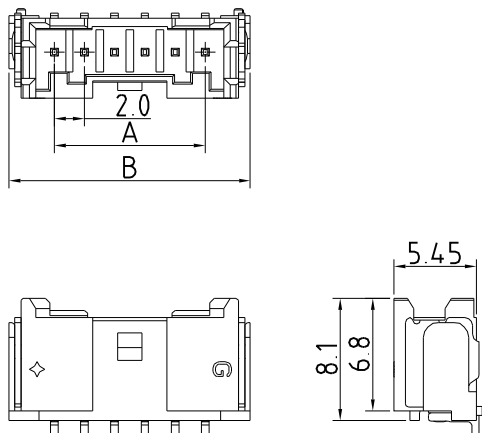

Dimension and Order Information

| Circuits | Part No. | DIM.(mm) | |
|----------|--------------|----------|-------|
| | | A | B |
| 8 | IPCW211W18*G | 14.00 | 20.00 |
| 9 | IPCW211W19*G | 16.00 | 22.00 |
| 10 | IPCW211W1A*G | 18.00 | 24.00 |
| 11 | IPCW211W1B*G | 20.00 | 26.00 |
| 12 | IPCW211W1C*G | 22.00 | 28.00 |
| 13 | IPCW211W1D*G | 24.00 | 30.00 |
| 14 | IPCW211W1E*G | 26.00 | 32.00 |
| 15 | IPCW211W1F*G | 28.00 | 34.00 |

X-ON Electronics

Largest Supplier of Electrical and Electronic Components

Click to view similar products for [Headers & Wire Housings](#) category:

Click to view products by [INCP](#) manufacturer:

Other Similar products are found below :

[57102-F02-18ULF](#) [58102-G61-06LF](#) [0009485154](#) [009176003701906](#) [0050291907](#) [00-9021-0611-00-339](#) [02.125.8002.8](#) [609-3404](#) [61062-3](#)
[622-0430](#) [622-3653LF](#) [63453-116](#) [636-1030](#) [636-1427](#) [636-3427](#) [636-4007](#) [641938-9](#) [644827-2](#) [65495-038](#) [65692-001LF](#) [65781-018](#)
[65781-047](#) [65817-010LF](#) [65817-015LF](#) [66207-023LF](#) [67016-026LF](#) [67095-007LF](#) [68631-112](#) [68645-018](#) [68648-049](#) [699319-000](#)
[70.362.1628.0](#) [70-4210](#) [70-4226B](#) [70-4853B](#) [707-5020](#) [707-5028](#) [71.350.2428.0](#) [71961-016LF](#) [733-134](#) [754199-000](#) [760-3052](#) [787-8014-00](#)
[FCN-367T-T012/H](#) [80.063.4001.1](#) [800-90-001-10-001000](#) [800-90-010-10-002000](#) [801-43-002-10-013000](#) [801-43-006-10-002000](#)
[803-41-018-10-001000](#)