

2.00mm Pitch Wire To Board Connector

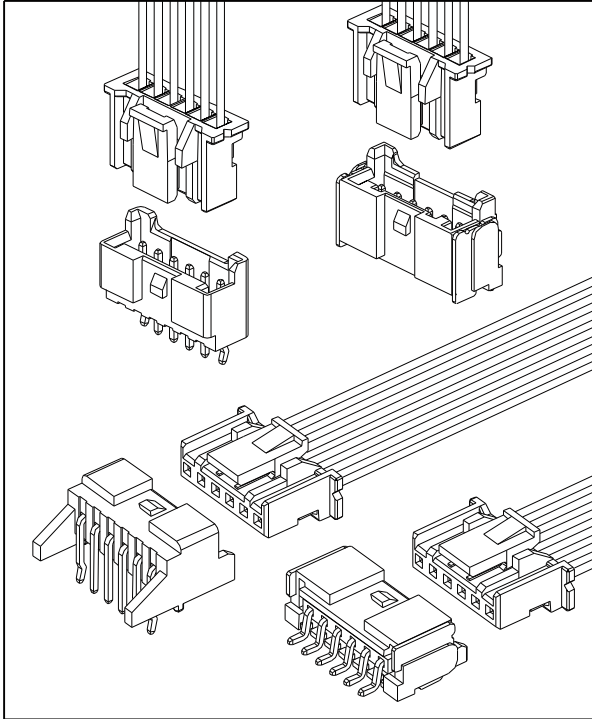

Specification

Circuits	02 - 16
Pitch	2.00mm
Current Rating	3A AC/DC
Voltage Rating	250V AC/DC
Contact Resistance	20mΩ MAX.
Withstand Voltage	800V AC/minute
Insulation Resistance	1,000MΩ MIN.
Temperature Range	-25°C - +105°C
Applicable Wire Range	AWG #22 - #28
Applicable P.C.B Thickness	1.6mm
Applicable P.C.B Hole Dia.	Ø0.8mm ± 0.05

Assembly Layout

Right Angle Type

DIP-Type

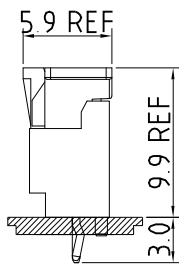

SMT-Type

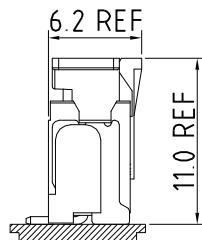

Vertical Type

DIP-Type

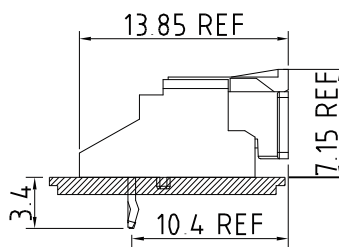

SMT-Type

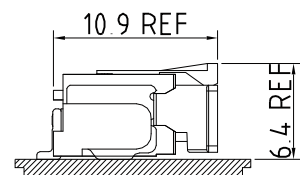

IPCW211 * ** * * * * *
 ① ② ③ ④ ⑤ ⑥ ⑦ ⑧

① Series Type. IPCW211

② Connector Type.

T: Terminal

W: Wafer

H: Housing

③ Pin code.

Row

Pin number of row

④ Material code.

⑤ Appereace code.

⑥ Internal code

⑦ Company code.

⑧ Other code.

Wafer

V: Vertical Type

R: Right Angle

S: Vertical SMT TYPE (02 - 08)

T: Vertical SMT TYPE (09 - 16)

M: Right Angle SMT TYPE

Unit : mm

Housing

Features

Available Number of Circuits : 02 - 16

Material : Regular Thermoplastic 94V-0

Use with : IPCW211 Crimp Terminal

Mates with : IPCW211 Series Wafer

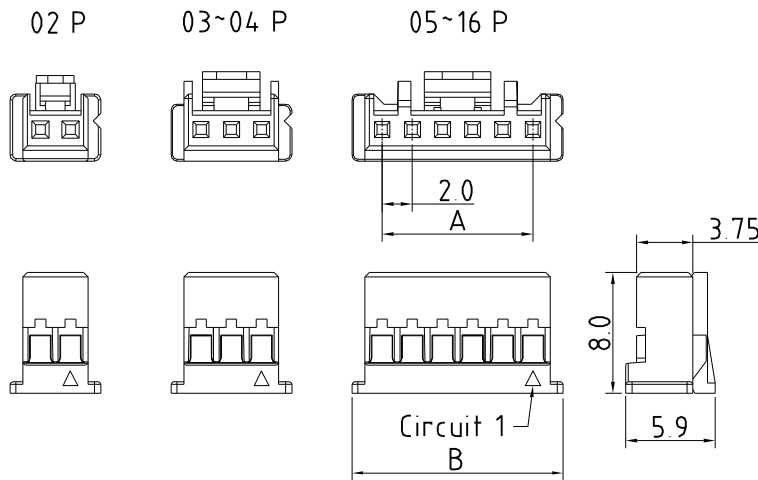

Dimension and Order Information

Circuits	Part No.	DIM.(mm)	
		A	B
2	IPCW211W12*	2.00	6.00
3	IPCW211H13*	4.00	8.00
4	IPCW211H14*	6.00	10.00
5	IPCW211H15*	8.00	12.00
6	IPCW211H16*	10.00	14.00
7	IPCW211H17*	12.00	16.00
8	IPCW211H18*	14.00	18.00
9	IPCW211H19*	16.00	20.00
10	IPCW211H1A*	18.00	22.00
11	IPCW211H1B*	20.00	24.00
12	IPCW211H1C*	22.00	26.00
13	IPCW211H1D*	24.00	28.00
14	IPCW211H1E*	26.00	30.00
15	IPCW211H1F*	28.00	32.00
16	IPCW211H1G*	30.00	34.00

Wafer

Vertical

Features

Available Number of Circuits : 02 - 16

Material : Regular Thermoplastic 94V-0

Contact : 0.5mm(.020") Copper Alloy, Tin-plated

Mates with : IPCW211 Series Housing

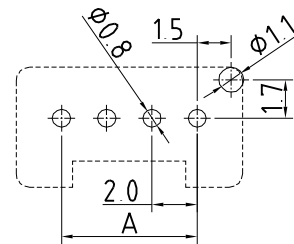
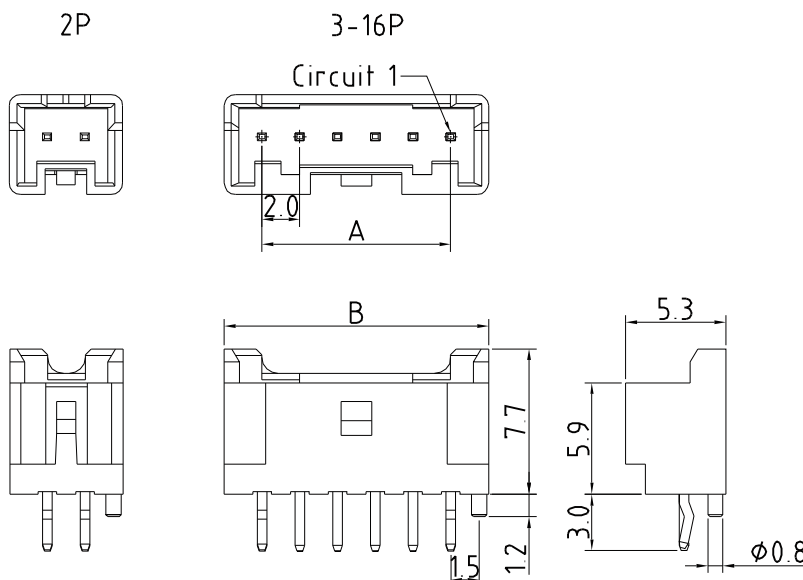

P.C.B LAYOUT

Dimension and Order Information

Circuits	Part No.	DIM.(mm)	
		A	B
2	IPCW211W12*V	2.00	6.00
3	IPCW211W13*V	4.00	8.00
4	IPCW211W14*V	6.00	10.00
5	IPCW211W15*V	8.00	12.00
6	IPCW211W16*V	10.00	14.00
7	IPCW211W17*V	12.00	16.00
8	IPCW211W18*V	14.00	18.00
9	IPCW211W19*V	16.00	20.00
10	IPCW211W1A*V	18.00	22.00
11	IPCW211W1B*V	20.00	24.00
12	IPCW211W1C*V	22.00	26.00
13	IPCW211W1D*V	24.00	28.00
14	IPCW211W1E*V	26.00	30.00
15	IPCW211W1F*V	28.00	32.00
16	IPCW211W1G*V	30.00	34.00

2.00mm Pitch Wire To Board Connector

Wafer

Right Angle

Features

Available Number of Circuits : 02 - 16

Material : Regular Thermoplastic 94V-0

Contact : 0.5mm(.020") Copper Alloy, Tin-plated

Mates with : IPCW211 Series Housing

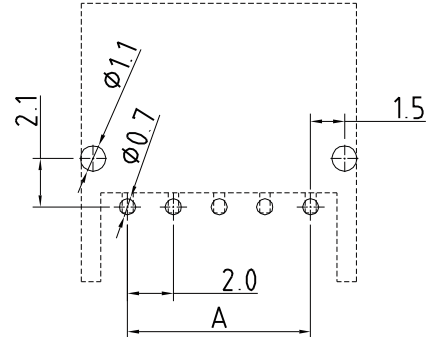
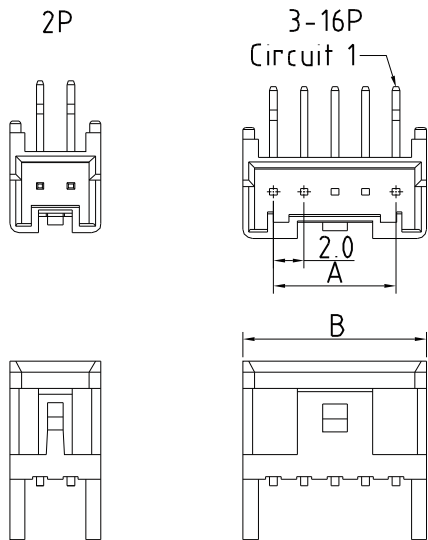

P.C.B LAYOUT

Dimension and Order Information

Circuits	Part No.	DIM.(mm)	
		A	B
2	IPCW211W12*R	2.00	5.96
3	IPCW211W13*R	4.00	7.96
4	IPCW211W14*R	6.00	9.96
5	IPCW211W15*R	8.00	11.96
6	IPCW211W16*R	10.00	13.96
7	IPCW211W17*R	12.00	15.96
8	IPCW211W18*R	14.00	17.96
9	IPCW211W19*R	16.00	19.96
10	IPCW211W1A*R	18.00	21.96
11	IPCW211W1B*R	20.00	23.96
12	IPCW211W1C*R	22.00	25.96
13	IPCW211W1D*R	24.00	27.96
14	IPCW211W1E*R	26.00	29.96
15	IPCW211W1F*R	28.00	31.96
16	IPCW211W1G*R	30.00	33.96

Wafer

Vertical SMT Type

Features

Available Number of Circuits : 02 - 15

Material : High Temperature Thermoplastic 94V-0

Contact: 0.5mm(.020") Copper Alloy, Matte-Tin

Mates with : IPCW211 Series Housing

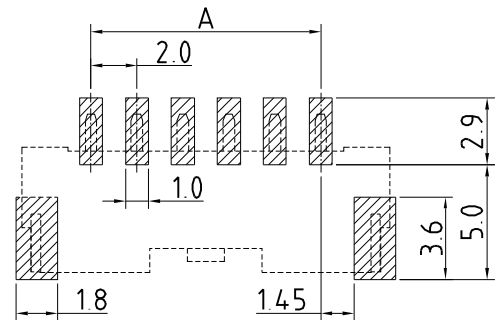
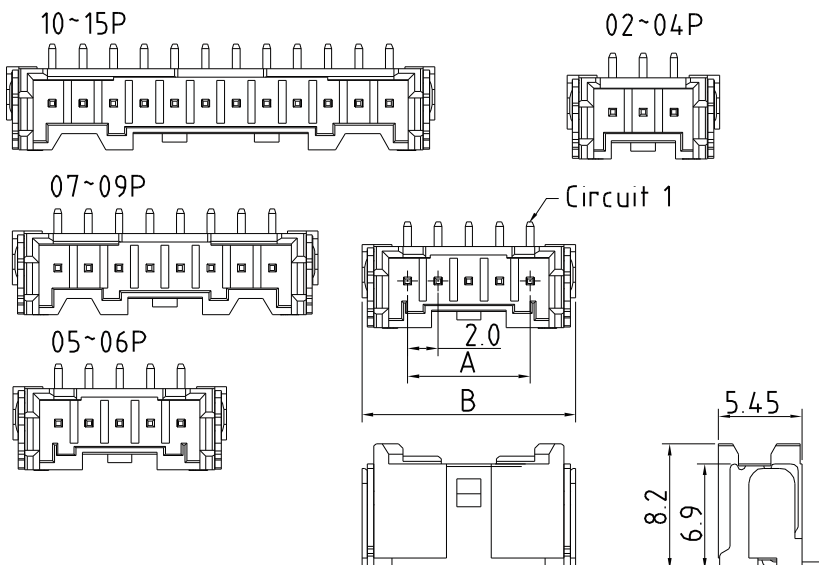

P.C.B LAYOUT

Dimension and Order Information

Circuits	Part No.	DIM.(mm)	
		A	B
2	IPCW211W12*S	2.00	8.00
3	IPCW211W13*S	4.00	10.00
4	IPCW211W14*S	6.00	12.00
5	IPCW211W15*S	8.00	14.00
6	IPCW211W16*S	10.00	16.00
7	IPCW211W17*S	12.00	18.00
8	IPCW211W18*S	14.00	20.00
9	IPCW211W19*S	16.00	22.00
10	IPCW211W1A*S	18.00	24.00
11	IPCW211W1B*S	20.00	26.00
12	IPCW211W1C*S	22.00	28.00
13	IPCW211W1D*S	24.00	30.00
14	IPCW211W1E*S	26.00	32.00
15	IPCW211W1F*S	28.00	34.00

2.00mm Pitch Wire To Board Connector

Wafer Vertical SMT Post Type

Features

- Available Number of Circuits : 02 - 15
- Material : High Temperature Thermoplastic 94V-0
- Contact : 0.5mm(.020") Copper Alloy, Matte-Tin
- Mates with : IPCW211 Series Housing

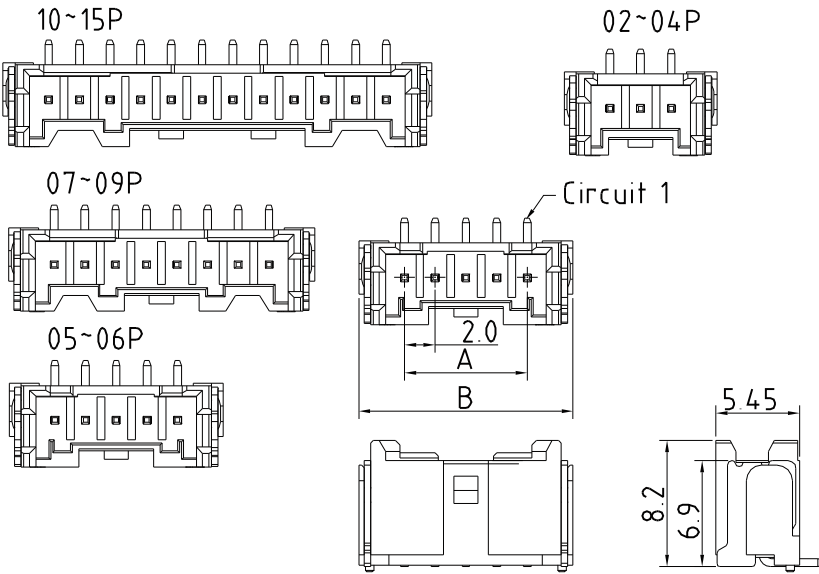
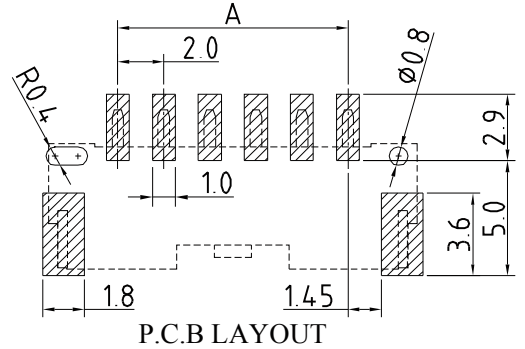

Dimension and Order Information

Circuits	Part No.	DIM.(mm)	
		A	B
2	IPCW211W12*P	2.00	8.00
3	IPCW211W13*P	4.00	10.00
4	IPCW211W14*P	6.00	12.00
5	IPCW211W15*P	8.00	14.00
6	IPCW211W16*P	10.00	16.00
7	IPCW211W17*P	12.00	18.00
8	IPCW211W18*P	14.00	20.00
9	IPCW211W19*P	16.00	22.00
10	IPCW211W1A*P	18.00	24.00
11	IPCW211W1B*P	20.00	26.00
12	IPCW211W1C*P	22.00	28.00
13	IPCW211W1D*P	24.00	30.00
14	IPCW211W1E*P	26.00	32.00
15	IPCW211W1F*P	28.00	34.00

Wafer Vertical SMT B Type

Features

- Available Number of Circuits : 02 - 15
- Material : High Temperature Thermoplastic 94V-0
- Contact : 0.5mm(.020") Copper Alloy, Matte-Tin
- Mates with : IPCW211 Series Housing

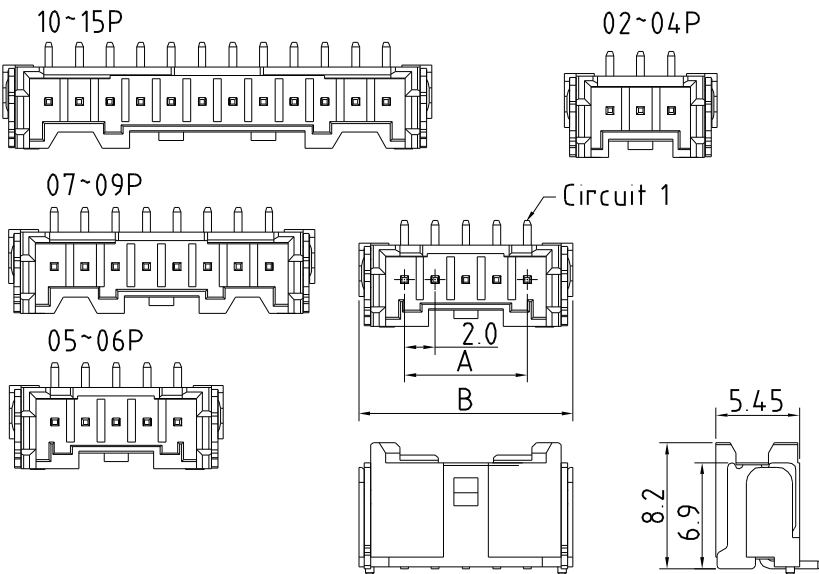
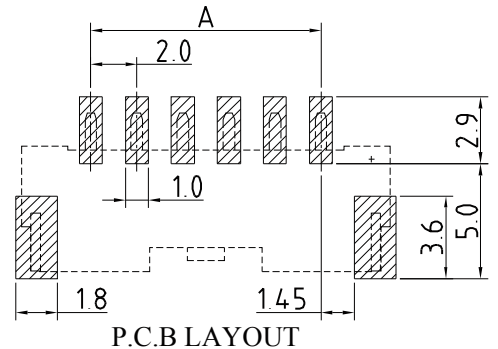

Dimension and Order Information

Circuits	Part No.	DIM.(mm)	
		A	B
2	IPCW211W12*B	2.00	8.00
3	IPCW211W13*B	4.00	10.00
4	IPCW211W14*B	6.00	12.00
5	IPCW211W15*B	8.00	14.00
6	IPCW211W16*B	10.00	16.00
7	IPCW211W17*B	12.00	18.00
8	IPCW211W18*B	14.00	20.00
9	IPCW211W19*B	16.00	22.00
10	IPCW211W1A*B	18.00	24.00
11	IPCW211W1B*B	20.00	26.00
12	IPCW211W1C*B	22.00	28.00
13	IPCW211W1D*B	24.00	30.00
14	IPCW211W1E*B	26.00	32.00
15	IPCW211W1F*B	28.00	34.00

2.00mm Pitch Wire To Board Connector

Wafer

Right Angle SMT Type

Unit : mm

Features

Available Number of Circuits : 02 - 15

Material : High Temperature Thermoplastic 94V-0

Contact: 0.5mm(.020") Copper Alloy, Matte-Tin

Mates with : IPCW211 Series Housing

02~04P



05~06P

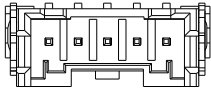
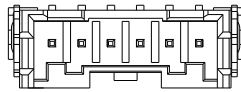

07

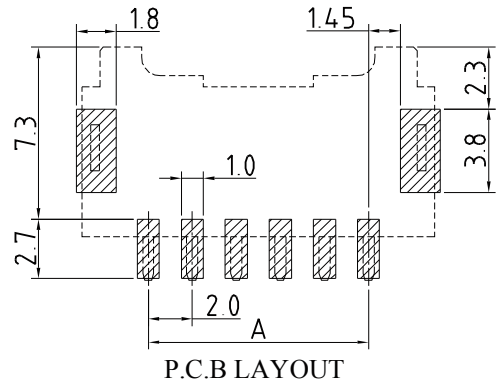
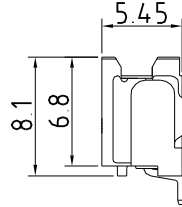
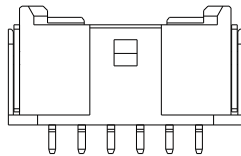
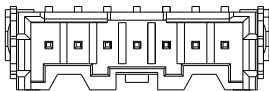

Dimension and Order Information

Circuits	Part No.	DIM.(mm)	
		A	B
2	IPCW211W12*A	2.00	8.00
3	IPCW211W13*A	4.00	10.00
4	IPCW211W14*A	6.00	12.00
5	IPCW211W15*A	8.00	14.00
6	IPCW211W16*A	10.00	16.00
7	IPCW211W17*A	12.00	18.00

Wafer

Right Angle SMT Type

Features

Available Number of Circuits :

Material : High Temperature Thermoplastic 94V-0

Contact: 0.5mm(.020") Copper Alloy, Matte-Tin

Mates with : IPCW211 Series Housing

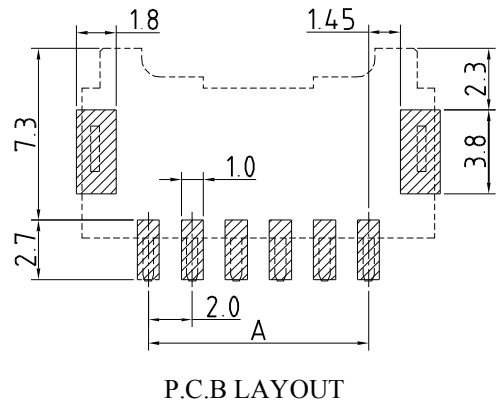
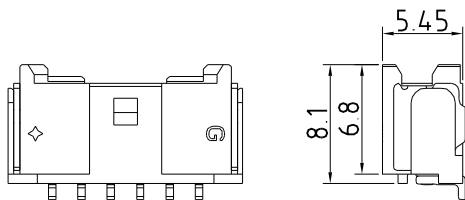
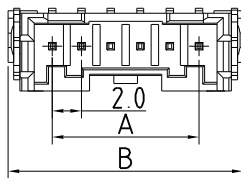

Dimension and Order Information

Circuits	Part No.	DIM.(mm)	
		A	B
8	IPCW211W18*M	14.00	20.00
9	IPCW211W19*M	16.00	22.00
10	IPCW211W1A*M	18.00	24.00
11	IPCW211W1B*M	20.00	26.00
12	IPCW211W1C*M	22.00	28.00
13	IPCW211W1D*M	24.00	30.00
14	IPCW211W1E*M	26.00	32.00
15	IPCW211W1F*M	28.00	34.00

2.00mm Pitch Wire To Board Connector

Unit : mm

Wafer

Right Angle SMT Post Type

Features

Available Number of Circuits : 02 - 15

Material : High Temperature Thermoplastic 94V-0

Contact: 0.5mm(.020") Copper Alloy, Matte-Tin

Mates with : IPCW211 Series Housing

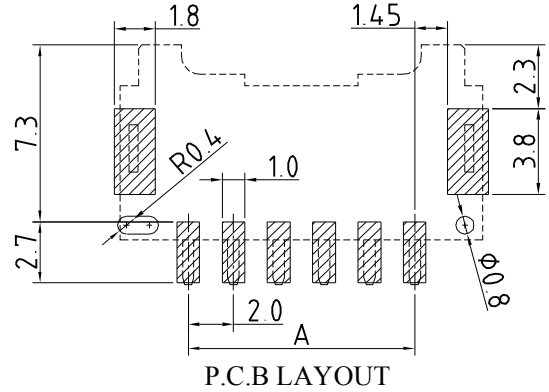
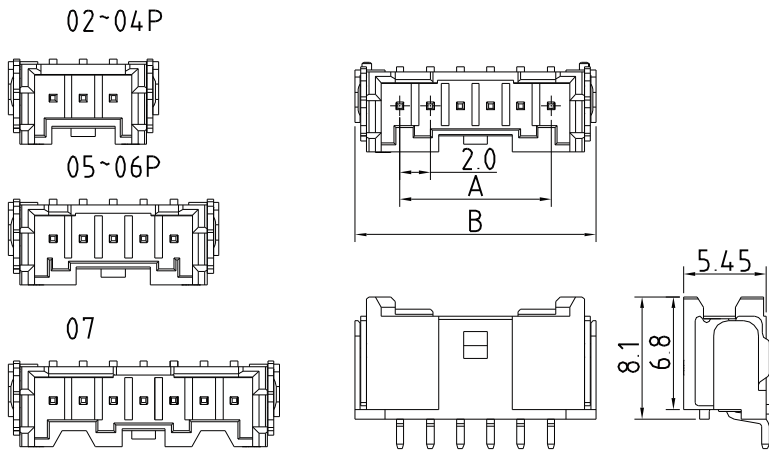

Dimension and Order Information

Circuits	Part No.	DIM.(mm)	
		A	B
2	IPCW211W12*E	2.00	8.00
3	IPCW211W13*E	4.00	10.00
4	IPCW211W14*E	6.00	12.00
5	IPCW211W15*E	8.00	14.00
6	IPCW211W16*E	10.00	16.00
7	IPCW211W17*E	12.00	18.00

Wafer

Right Angle SMT Post Type

Features

Available Number of Circuits : 02 - 15

Material : High Temperature Thermoplastic 94V-0

Contact: 0.5mm(.020") Copper Alloy, Matte-Tin

Mates with : IPCW211 Series Housing

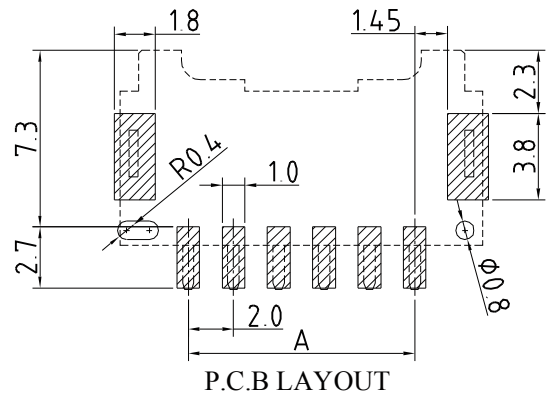
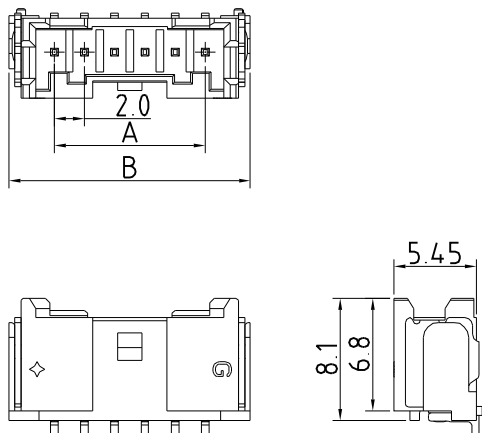

Dimension and Order Information

Circuits	Part No.	DIM.(mm)	
		A	B
8	IPCW211W18*G	14.00	20.00
9	IPCW211W19*G	16.00	22.00
10	IPCW211W1A*G	18.00	24.00
11	IPCW211W1B*G	20.00	26.00
12	IPCW211W1C*G	22.00	28.00
13	IPCW211W1D*G	24.00	30.00
14	IPCW211W1E*G	26.00	32.00
15	IPCW211W1F*G	28.00	34.00

X-ON Electronics

Largest Supplier of Electrical and Electronic Components

Click to view similar products for [Headers & Wire Housings](#) category:

Click to view products by [INCP](#) manufacturer:

Other Similar products are found below :

[57102-F02-18ULF](#) [58102-G61-06LF](#) [0009485154](#) [009176003701906](#) [0050291907](#) [00-9021-0611-00-339](#) [02.125.8002.8](#) [609-3404](#) [61062-3](#)
[622-0430](#) [622-3653LF](#) [63453-116](#) [636-1030](#) [636-1427](#) [636-3427](#) [636-4007](#) [641938-9](#) [644827-2](#) [65495-038](#) [65692-001LF](#) [65781-018](#)
[65781-047](#) [65817-010LF](#) [65817-015LF](#) [66207-023LF](#) [67016-026LF](#) [67095-007LF](#) [68631-112](#) [68645-018](#) [68648-049](#) [699319-000](#)
[70.362.1628.0](#) [70-4210](#) [70-4226B](#) [70-4853B](#) [707-5020](#) [707-5028](#) [71.350.2428.0](#) [71961-016LF](#) [733-134](#) [754199-000](#) [760-3052](#) [787-8014-00](#)
[FCN-367T-T012/H](#) [80.063.4001.1](#) [800-90-001-10-001000](#) [800-90-010-10-002000](#) [801-43-002-10-013000](#) [801-43-006-10-002000](#)
[803-41-018-10-001000](#)