

3.96mm Pitch Wire To Board Connector

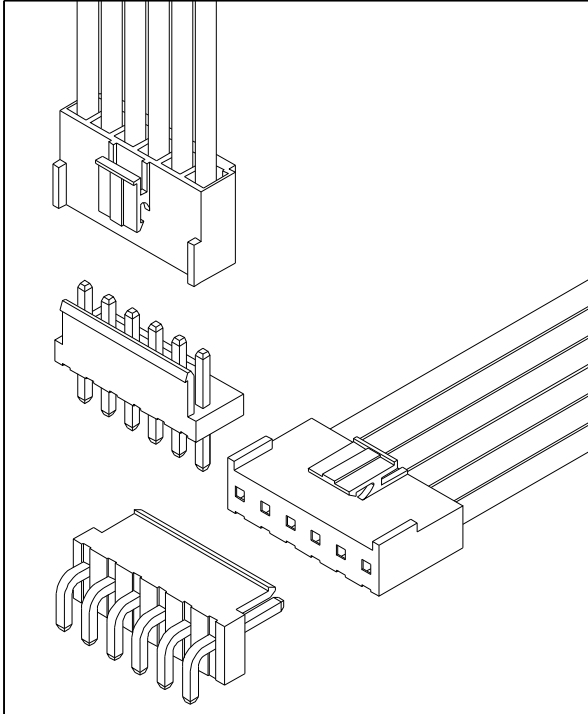

Specification

Circuits	02 - 12
Pitch	3.96mm
Current Rating	7A AC/DC(AWG#18)
	6A AC/DC(AWG#20)
	5.5A AC/DC(AWG#22)
Voltage Rating	250V AC/DC
Contact Resistance	10mΩ MAX.
Withstand Voltage	1,500V AC/minute
Insulation Resistance	1,000MΩ MIN.
Temperature Range	-40°C - +105°C
Applicable Wire Range	AWG #18 - #22
Applicable P.C.B Thickness	1.6mm
Applicable P.C.B Hole Dia.	∅ 1.7mm ± 0.05

Assembly Layout

Vertical Type

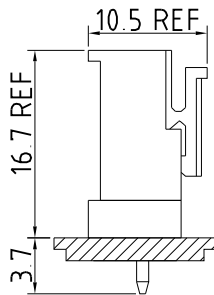

Right Angle Type

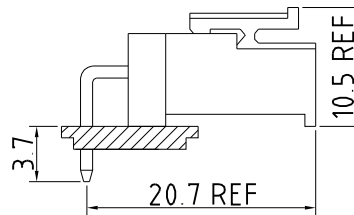

IPCW396 * ** * * * * *
 ① ② ③ ④ ⑤ ⑥ ⑦ ⑧

- ① Series Type. IPCW396
- ② Connector Type.
T: Terminal
W: Wafer
H: Housing
- ③ Pin code.
Terminal: Serial number
Wafer or Housing: x row x pin number of row
- ④ Material code.
- ⑤ Appearance code.
- ⑥ Internal code
- ⑦ Company code.

- ⑧ Other code.
Wafer
V: Vertical Type
R: Right Angle

3.96mm Pitch Wire To Board Connector

Unit : mm

Terminal

Features

Use with: IPCW396 Series Housing

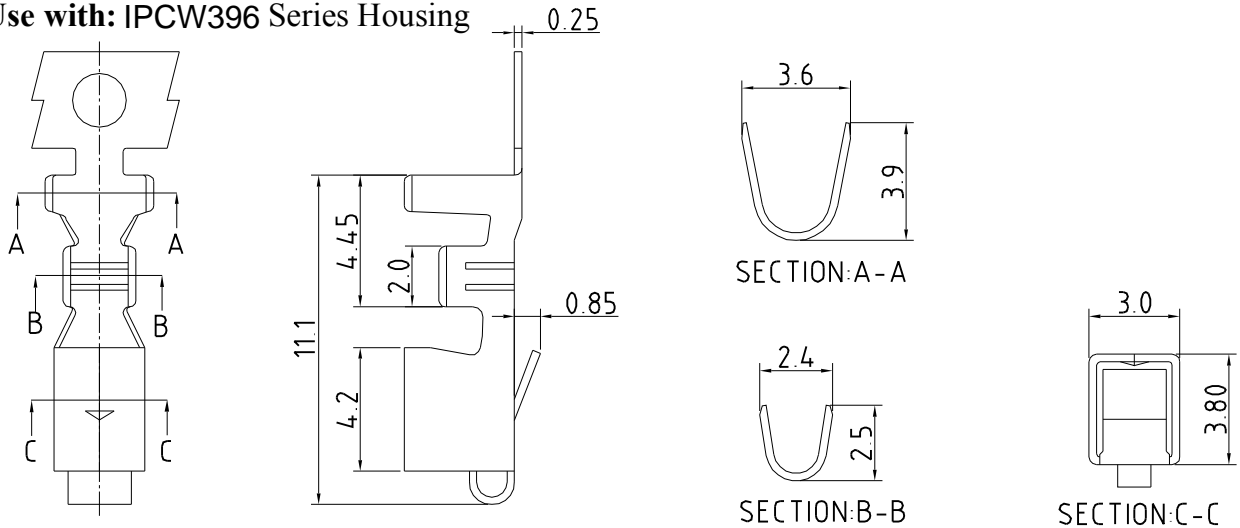

CONTACT INFORMATION

Part No.	Wire Range	Insulation O.D.	Material	Finish	Q'ty/Reel
IPCW396T01*	AWG #18-#22	2.80mm(MAX.)	Phosphor bronze	See note	4,000 pcs
IPCW396T02*	AWG #18-#22	2.80mm(MAX.)	Brass	See note	4,000 pcs

Housing

Features

Available Number of Circuits: 02 - 12

Material: Regular Thermoplastic 94V-0

Use with: IPCW396 Crimp Terminal

Mates with :IPCW396 Series Wafer

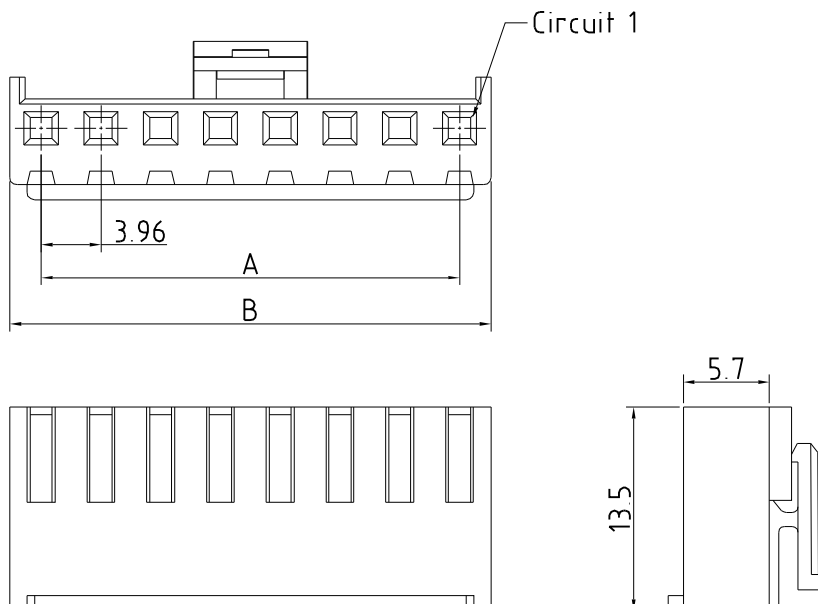

Dimension and Order Information

Circuits	Part No.	DIM.(mm)	
		A	B
2	IPCW396H12*	3.96	7.92
3	IPCW396H13*	7.92	11.88
4	IPCW396H14*	11.88	15.84
5	IPCW396H15*	15.84	19.80
6	IPCW396H16*	19.80	23.76
7	IPCW396H17*	23.76	27.72
8	IPCW396H18*	27.72	31.68
9	IPCW396H19*	31.68	35.64
10	IPCW396H1A*	35.64	39.60
11	IPCW396H1B*	39.60	43.56
12	IPCW396H1C*	43.56	47.52

3.96mm Pitch Wire To Board Connector

Unit : mm

Wafer

Vertical

Features

Available Number of Circuits : 02 - 12

Material : Regular Thermoplastic 94V-0

Contact: 1.14mm(.045") Copper Alloy, Tin-plated

Mates with : IPCW396 Series Housing

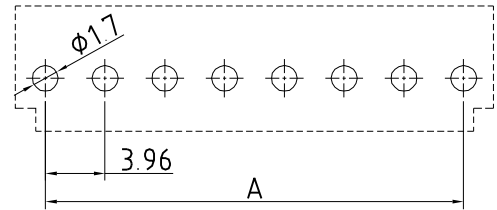
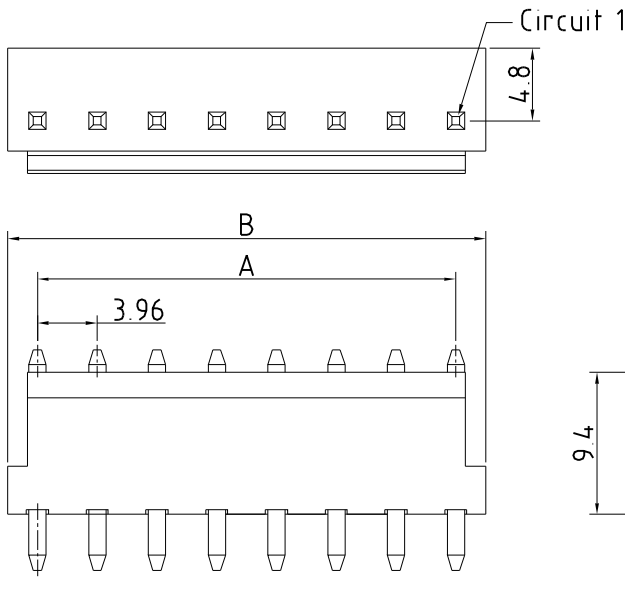

P.C.B LAYOUT

Dimension and Order Information

Circuits	Part No.	DIM.(mm)	
		A	B
2	IPCW396W12*V	3.96	7.92
3	IPCW396W13*V	7.92	11.88
4	IPCW396W14*V	11.88	15.84
5	IPCW396W15*V	15.84	19.80
6	IPCW396W16*V	19.80	23.76
7	IPCW396W17*V	23.76	27.72
8	IPCW396W18*V	27.72	31.68
9	IPCW396W19*V	31.68	35.64
10	IPCW396W1A*V	35.64	39.60
11	IPCW396W1B*V	39.60	43.56
12	IPCW396W1C*V	43.56	47.52

Wafer

Right Angle

Features

Available Number of Circuits : 02 - 12

Material : Regular Thermoplastic 94V-0

Contact: 1.14mm(.045") Copper Alloy, Tin-plated

Mates with : IPCW396 Series Housing

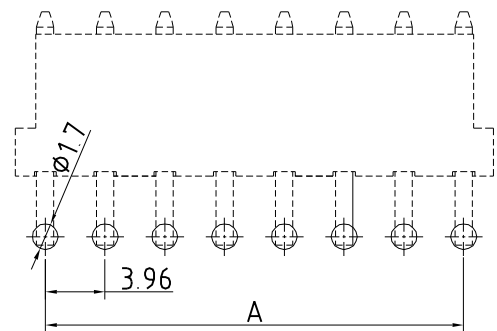
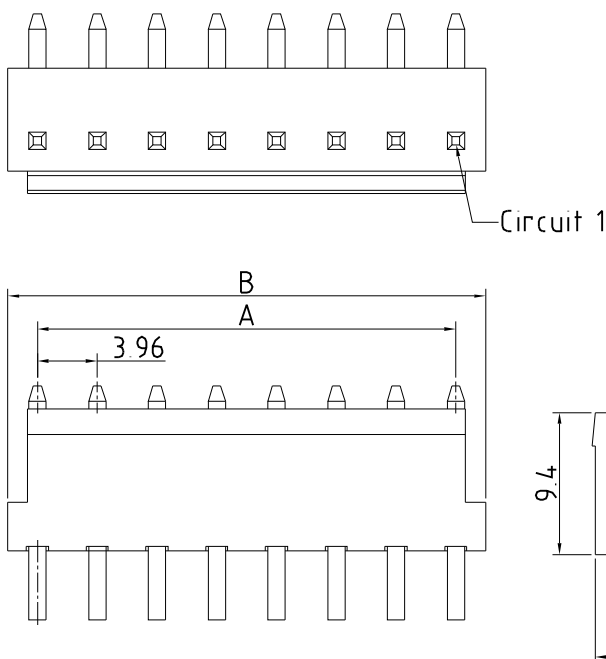

P.C.B LAYOUT

Dimension and Order Information

Circuits	Part No.	DIM.(mm)	
		A	B
2	IPCW396W12*R	3.96	7.92
3	IPCW396W13*R	7.92	11.88
4	IPCW396W14*R	11.88	15.84
5	IPCW396W15*R	15.84	19.80
6	IPCW396W16*R	19.80	23.76
7	IPCW396W17*R	23.76	27.72
8	IPCW396W18*R	27.72	31.68
9	IPCW396W19*R	31.68	35.64
10	IPCW396W1A*R	35.64	39.60
11	IPCW396W1B*R	39.60	43.56
12	IPCW396W1C*R	43.56	47.52

X-ON Electronics

Largest Supplier of Electrical and Electronic Components

Click to view similar products for [Headers & Wire Housings](#) category:

Click to view products by [INCP](#) manufacturer:

Other Similar products are found below :

[57102-F02-18ULF](#) [58102-G61-06LF](#) [0009485154](#) [009176003701906](#) [0050291907](#) [00-9021-0611-00-339](#) [02.125.8002.8](#) [609-3404](#) [61062-3](#)
[622-0430](#) [622-3653LF](#) [63453-116](#) [636-1030](#) [636-1427](#) [636-3427](#) [636-4007](#) [641938-9](#) [644827-2](#) [65495-038](#) [65692-001LF](#) [65781-018](#)
[65781-047](#) [65817-010LF](#) [65817-015LF](#) [66207-023LF](#) [67016-026LF](#) [67095-007LF](#) [68631-112](#) [68645-018](#) [68648-049](#) [699319-000](#)
[70.362.1628.0](#) [70-4210](#) [70-4226B](#) [70-4853B](#) [707-5020](#) [707-5028](#) [71.350.2428.0](#) [71961-016LF](#) [733-134](#) [754199-000](#) [760-3052](#) [787-8014-00](#)
[FCN-367T-T012/H](#) [80.063.4001.1](#) [800-90-001-10-001000](#) [800-90-010-10-002000](#) [801-43-002-10-013000](#) [801-43-006-10-002000](#)
[803-41-018-10-001000](#)