

3.96mm Pitch Wire To Board Connector

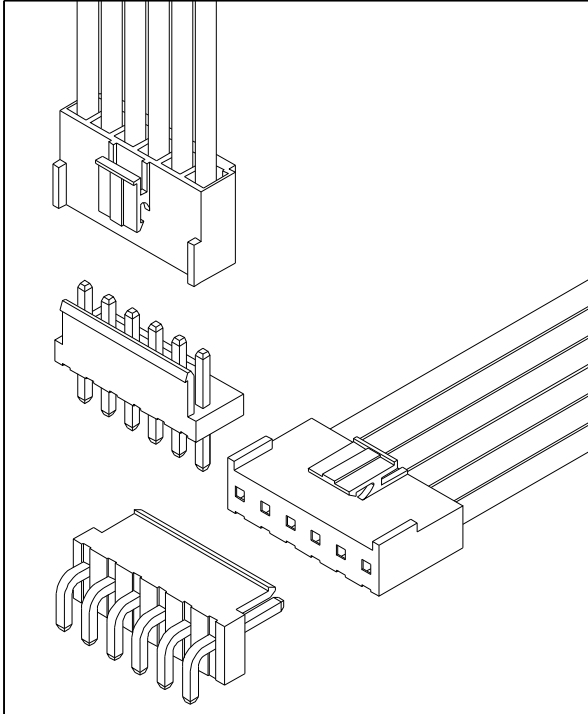

Specification

| | |
|----------------------------|--------------------|
| Circuits | 02 - 12 |
| Pitch | 3.96mm |
| Current Rating | 7A AC/DC(AWG#18) |
| | 6A AC/DC(AWG#20) |
| | 5.5A AC/DC(AWG#22) |
| Voltage Rating | 250V AC/DC |
| Contact Resistance | 10mΩ MAX. |
| Withstand Voltage | 1,500V AC/minute |
| Insulation Resistance | 1,000MΩ MIN. |
| Temperature Range | -40°C - +105°C |
| Applicable Wire Range | AWG #18 - #22 |
| Applicable P.C.B Thickness | 1.6mm |
| Applicable P.C.B Hole Dia. | Ø 1.7mm ± 0.05 |

Assembly Layout

Vertical Type

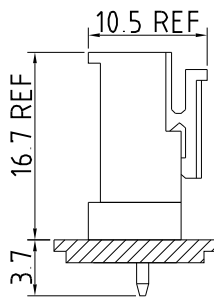

Right Angle Type

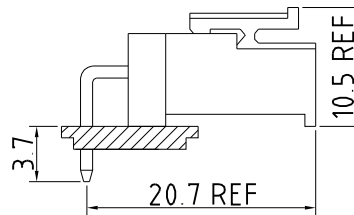

IPCW396 * ** * * * * *
 ① ② ③ ④ ⑤ ⑥ ⑦ ⑧

- ① Series Type. IPCW396
- ② Connector Type.
T: Terminal
W: Wafer
H: Housing
- ③ Pin code.
Terminal: Serial number
Wafer or Housing: x row x pin number of row
- ④ Material code.
- ⑤ Appearance code.
- ⑥ Internal code
- ⑦ Company code.

- ⑧ Other code.
Wafer
V: Vertical Type
R: Right Angle

3.96mm Pitch Wire To Board Connector

Unit : mm

Terminal

Features

Use with: IPCW396 Series Housing

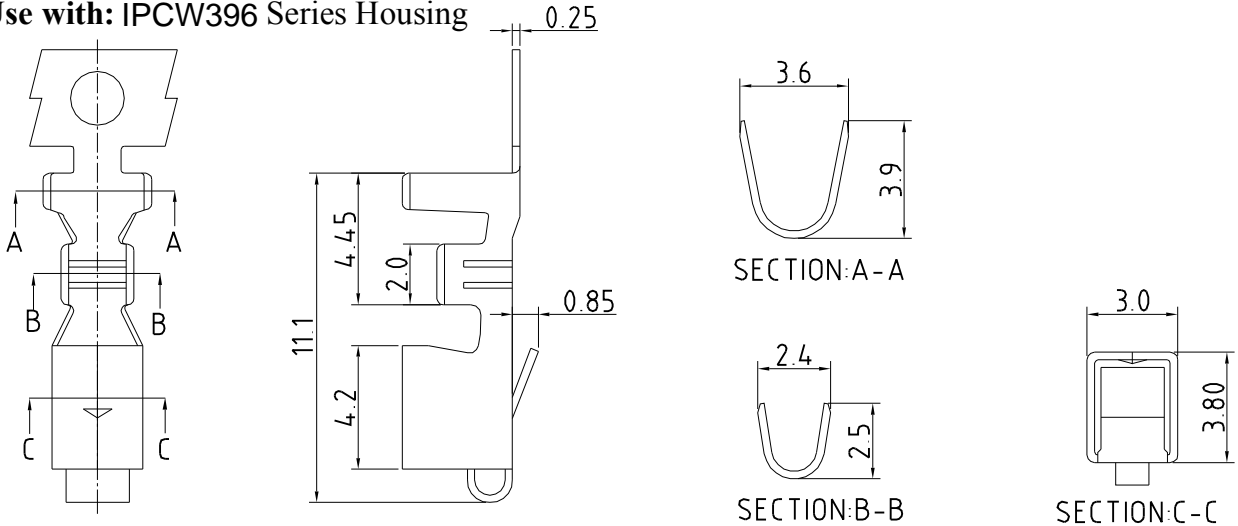

CONTACT INFORMATION

| Part No. | Wire Range | Insulation O.D. | Material | Finish | Q'ty/Reel |
|-------------|-------------|-----------------|-----------------|----------|-----------|
| IPCW396T01* | AWG #18-#22 | 2.80mm(MAX.) | Phosphor bronze | See note | 4,000 pcs |
| IPCW396T02* | AWG #18-#22 | 2.80mm(MAX.) | Brass | See note | 4,000 pcs |

Housing

Features

Available Number of Circuits: 02 - 12

Material: Regular Thermoplastic 94V-0

Use with: IPCW396 Crimp Terminal

Mates with :IPCW396 Series Wafer

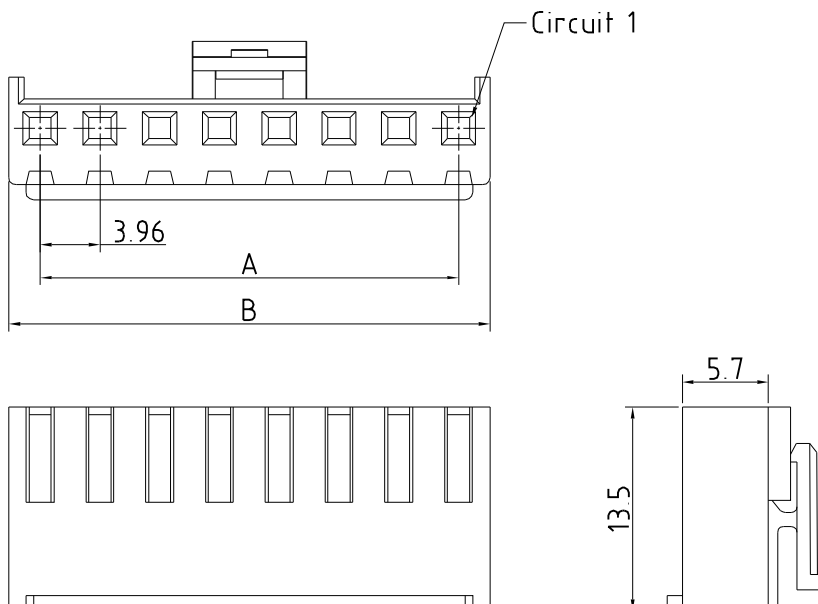

Dimension and Order Information

| Circuits | Part No. | DIM.(mm) | |
|----------|-------------|----------|-------|
| | | A | B |
| 2 | IPCW396H12* | 3.96 | 7.92 |
| 3 | IPCW396H13* | 7.92 | 11.88 |
| 4 | IPCW396H14* | 11.88 | 15.84 |
| 5 | IPCW396H15* | 15.84 | 19.80 |
| 6 | IPCW396H16* | 19.80 | 23.76 |
| 7 | IPCW396H17* | 23.76 | 27.72 |
| 8 | IPCW396H18* | 27.72 | 31.68 |
| 9 | IPCW396H19* | 31.68 | 35.64 |
| 10 | IPCW396H1A* | 35.64 | 39.60 |
| 11 | IPCW396H1B* | 39.60 | 43.56 |
| 12 | IPCW396H1C* | 43.56 | 47.52 |

3.96mm Pitch Wire To Board Connector

Unit : mm

Wafer

Vertical

Features

Available Number of Circuits : 02 - 12

Material : Regular Thermoplastic 94V-0

Contact: 1.14mm(.045") Copper Alloy, Tin-plated

Mates with : IPCW396 Series Housing

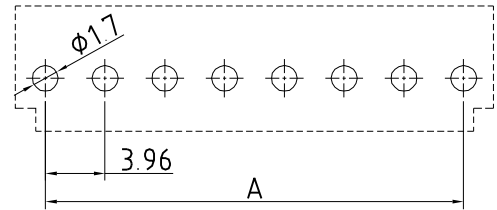
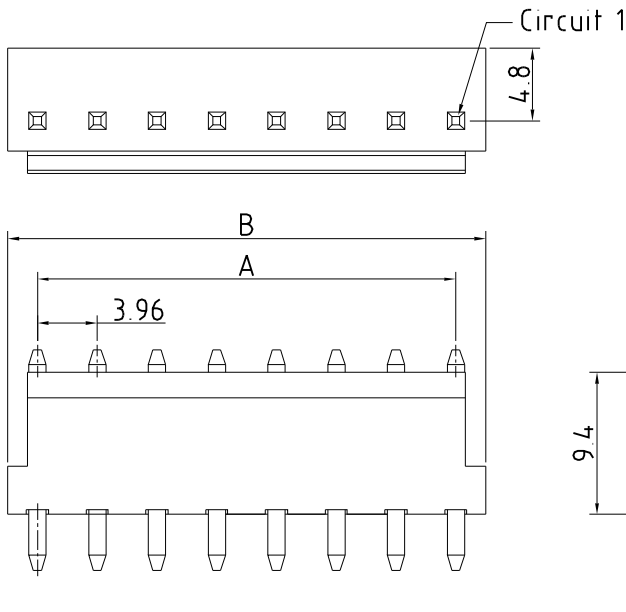

P.C.B LAYOUT

Dimension and Order Information

| Circuits | Part No. | DIM.(mm) | |
|----------|--------------|----------|-------|
| | | A | B |
| 2 | IPCW396W12*V | 3.96 | 7.92 |
| 3 | IPCW396W13*V | 7.92 | 11.88 |
| 4 | IPCW396W14*V | 11.88 | 15.84 |
| 5 | IPCW396W15*V | 15.84 | 19.80 |
| 6 | IPCW396W16*V | 19.80 | 23.76 |
| 7 | IPCW396W17*V | 23.76 | 27.72 |
| 8 | IPCW396W18*V | 27.72 | 31.68 |
| 9 | IPCW396W19*V | 31.68 | 35.64 |
| 10 | IPCW396W1A*V | 35.64 | 39.60 |
| 11 | IPCW396W1B*V | 39.60 | 43.56 |
| 12 | IPCW396W1C*V | 43.56 | 47.52 |

Wafer

Right Angle

Features

Available Number of Circuits : 02 - 12

Material : Regular Thermoplastic 94V-0

Contact: 1.14mm(.045") Copper Alloy, Tin-plated

Mates with : IPCW396 Series Housing

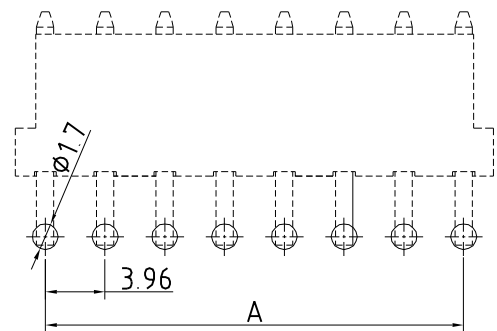
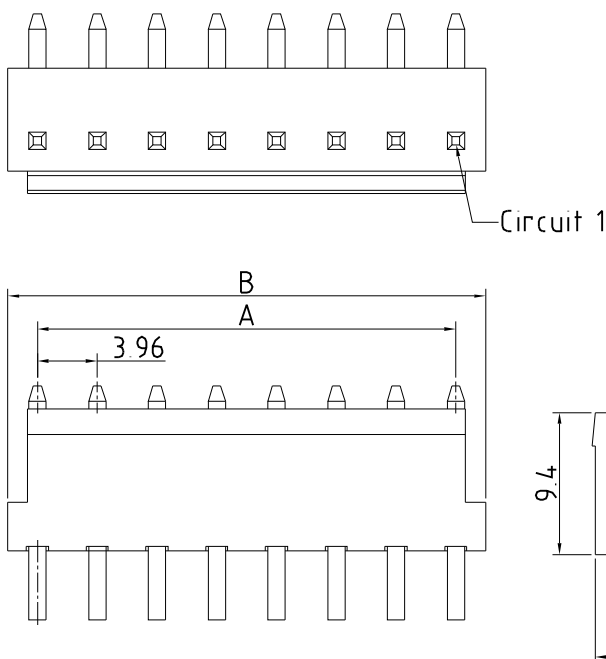

P.C.B LAYOUT

Dimension and Order Information

| Circuits | Part No. | DIM.(mm) | |
|----------|--------------|----------|-------|
| | | A | B |
| 2 | IPCW396W12*R | 3.96 | 7.92 |
| 3 | IPCW396W13*R | 7.92 | 11.88 |
| 4 | IPCW396W14*R | 11.88 | 15.84 |
| 5 | IPCW396W15*R | 15.84 | 19.80 |
| 6 | IPCW396W16*R | 19.80 | 23.76 |
| 7 | IPCW396W17*R | 23.76 | 27.72 |
| 8 | IPCW396W18*R | 27.72 | 31.68 |
| 9 | IPCW396W19*R | 31.68 | 35.64 |
| 10 | IPCW396W1A*R | 35.64 | 39.60 |
| 11 | IPCW396W1B*R | 39.60 | 43.56 |
| 12 | IPCW396W1C*R | 43.56 | 47.52 |

X-ON Electronics

Largest Supplier of Electrical and Electronic Components

Click to view similar products for [Headers & Wire Housings](#) category:

Click to view products by [INCP](#) manufacturer:

Other Similar products are found below :

[57102-F02-18ULF](#) [58102-G61-06LF](#) [0009485154](#) [009176003701906](#) [0050291907](#) [00-9021-0611-00-339](#) [02.125.8002.8](#) [609-3404](#) [61062-3](#)
[622-0430](#) [622-3653LF](#) [63453-116](#) [636-1030](#) [636-1427](#) [636-3427](#) [636-4007](#) [641938-9](#) [644827-2](#) [65495-038](#) [65692-001LF](#) [65781-018](#)
[65781-047](#) [65817-010LF](#) [65817-015LF](#) [66207-023LF](#) [67016-026LF](#) [67095-007LF](#) [68631-112](#) [68645-018](#) [68648-049](#) [699319-000](#)
[70.362.1628.0](#) [70-4210](#) [70-4226B](#) [70-4853B](#) [707-5020](#) [707-5028](#) [71.350.2428.0](#) [71961-016LF](#) [733-134](#) [754199-000](#) [760-3052](#) [787-8014-00](#)
[FCN-367T-T012/H](#) [80.063.4001.1](#) [800-90-001-10-001000](#) [800-90-010-10-002000](#) [801-43-002-10-013000](#) [801-43-006-10-002000](#)
[803-41-018-10-001000](#)