

Engineer Drawing

SPECIFICATIONS:

1. Poles: 2~24
2. Applicable: AWG #24~#16
3. Voltage Rating: 300V DC/AC
4. Current Rating: 9.0A
5. Withstand Voltage: 1500V AC
6. Working Temperature: -25°C ~ +85°C
7. Insulation Resistance: $\geq 1000\text{M}\Omega$ (Min)
8. Contact Resistance: $\leq 20\text{M}\Omega$ (Max)
9. Material: Nylon UL 94V-2(0)/Brass

IPCW 420 W XX X X XX X

① ② ③ ④ ⑤ ⑥ ⑦ ⑧

- | | |
|-------------------------|-----------------|
| ① Series Type | ⑤ Material Code |
| ② Pitch: 4.20mm | ⑥ Colour Code |
| ③ Connector Type | ⑦ Serial Code |
| ④ Pin Code: See Table 1 | ⑧ Other Code |

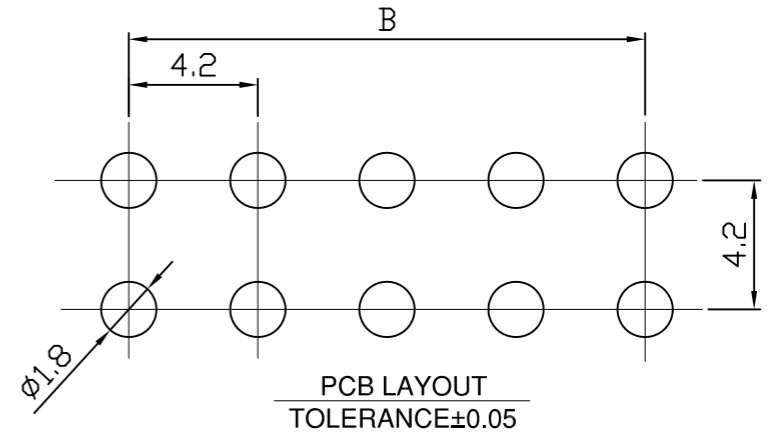
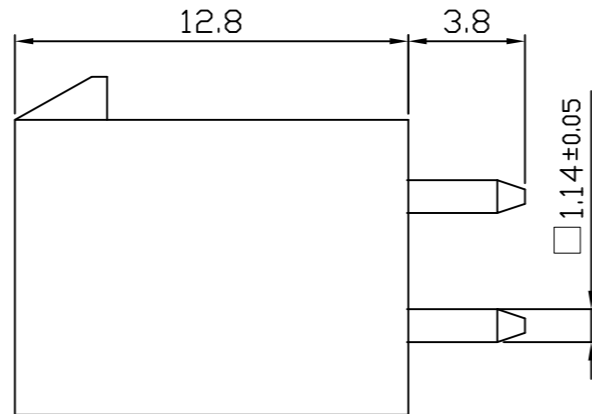
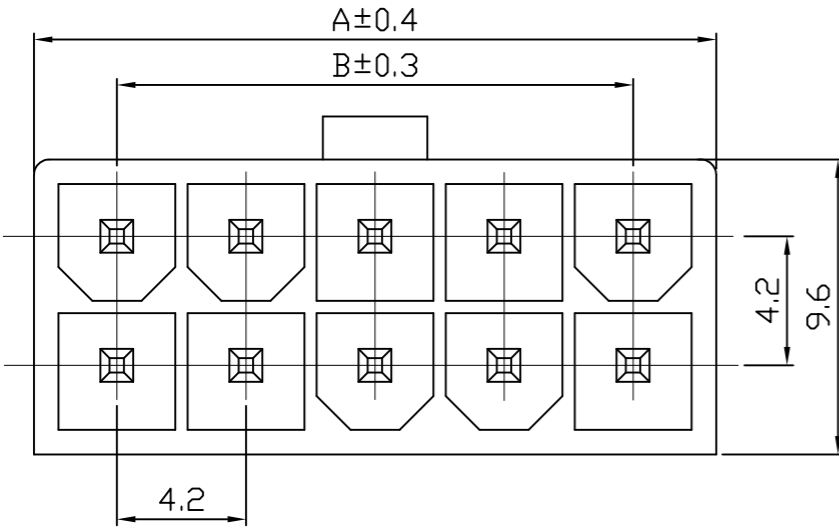

Table 1

Pin Code	Circuits	Dimensions(mm)	
		A	B
22	4	5.4	/
24	8	9.6	4.2
26	12	13.8	8.4
28	16	18.0	12.6
2A	20	22.2	16.8
2C	24	26.6	21.0
2E	28	30.6	25.2
2G	32	34.8	29.4
2J	36	39.0	33.6
2L	40	43.2	37.8
2N	44	47.4	42.0
2Q	48	51.6	46.2

TOLERANCES:

- X. = ± 0.40
- X.X = ± 0.30
- X.XX = ± 0.20
- GENERAL ANGLE
- X° = $\pm 5^\circ$
- X.X° = $\pm 4^\circ$
- X.XX° = $\pm 3^\circ$



www.i-ncp.com

PART NO:
IPCW420W xx 0AV

DRAWING NO
IPCW420W0AV

NAME:
4.2mmPH 2xnPin 180° Wire
to Board

⊕ SHEET 1 OF 1 UNITS:mm SCALE:1:1 REV.01

Engineer Drawing

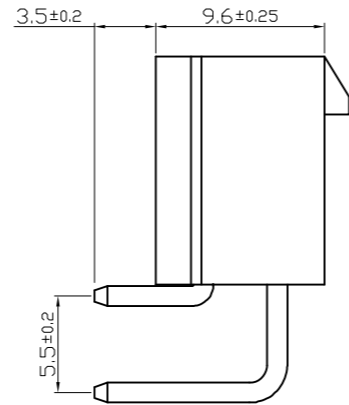
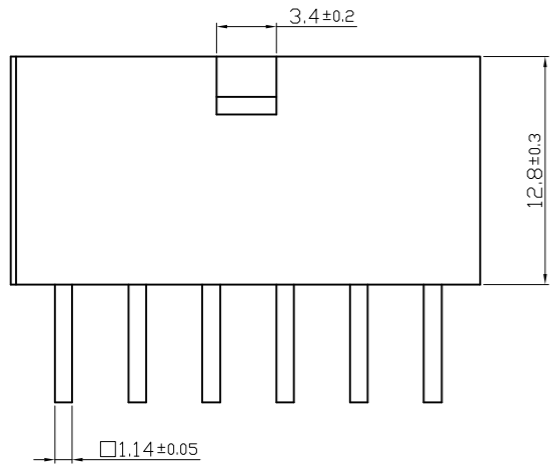

SPECIFICATIONS:

1. Poles: 2~24
2. Applicable: AWG #24~#16
3. Withstand Voltage: 1500V AC
4. Working Temperature: -25°C ~ +85°C
5. Insulation Resistance: ≥ 1000MΩ (Min)
6. Material: Nylon UL 94V-0(2)/Brass: 1.14mm

IPCW 420 W XX X X XX X

① ② ③ ④ ⑤ ⑥ ⑦ ⑧

- | | |
|-------------------------|-----------------|
| ① Series Type | ⑤ Material Code |
| ② Pitch: 4.20mm | ⑥ Colour Code |
| ③ Connector Type | ⑦ Serial Code |
| ④ Pin Code: See Table 1 | ⑧ Other Code |

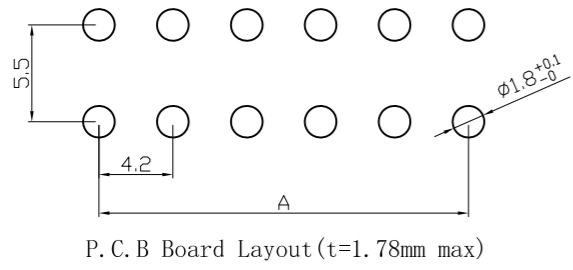
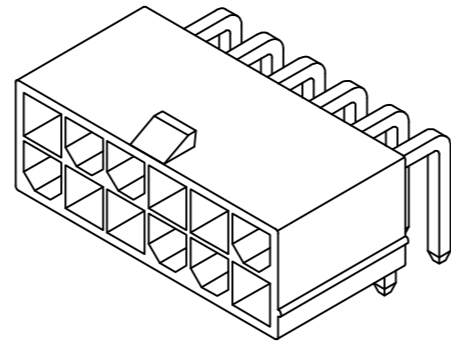
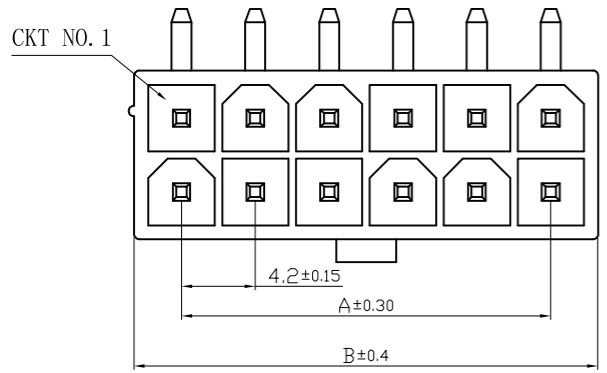

P.C.B Board Layout (t=1.78mm max)

Table 1

Pin Code	Circuits	Dimensions(mm)		Pin Code	Circuits	Dimensions(mm)	
		A	B			A	B
22	4	/	5.40	2E	28	25.2	30.6
24	8	4.20	9.60	2G	32	29.4	34.8
26	12	8.40	13.8	2J	36	33.6	39.0
28	16	12.6	18.0	2L	40	37.8	43.2
2A	20	16.8	22.2	2N	44	42.0	47.4
2C	24	21.0	26.4	2Q	48	46.2	51.6

TOLERANCES:
 X: ±0.40
 X.X: ±0.3
 X.XX: ±0.20
 GENERAL ANGLE
 X°: ±5°
 X.X°: ±4°
 X.XX°: ±3°

	www.i-ncp.com
PART NO: IPCW420W xx 0AR	NAME: 4.2mmPH 2xnPin 90° Wire to Board
DRAWING NO IPCW420W0AR	
SHEET 1 OF 1	UNITS:mm SCALE:1:1 REV:01

Engineer Drawing

SPECIFICATIONS:

1. Poles: 2~24
2. Applicable: AWG #24~#16
3. Voltage Rating: 300V DC/AC
4. Current Rating: 9.0A
5. Withstand Voltage: 1500V AC
6. Working Temperature: -25°C ~ +85°C
7. Insulation Resistance: $\geq 1000\text{M}\Omega(\text{Min})$
8. Contact Resistance: $\leq 20\text{M}\Omega(\text{Max})$
9. Material: Nylon UL 94V-0

IPCW 420 H XX X X XX X

① ② ③ ④ ⑤ ⑥ ⑦ ⑧

- | | |
|-------------------------|-----------------|
| ① Series Type | ⑤ Material Code |
| ② Pitch: 4.20mm | ⑥ Colour Code |
| ③ Connector Type | ⑦ Serial Code |
| ④ Pin Code: See Table 1 | ⑧ Other Code |

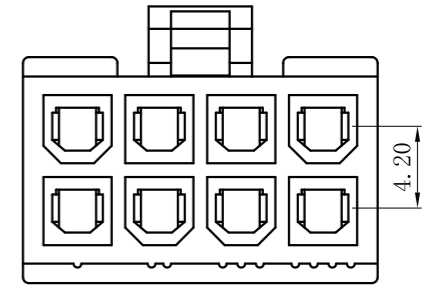
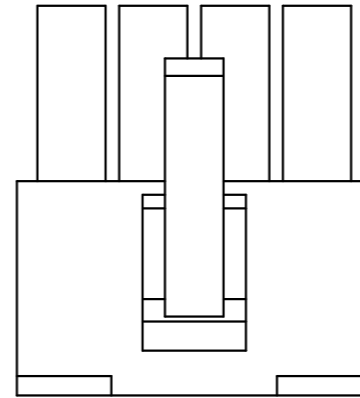
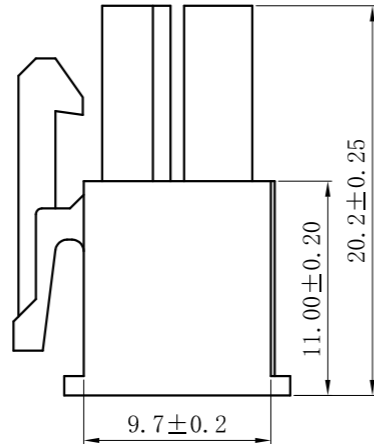
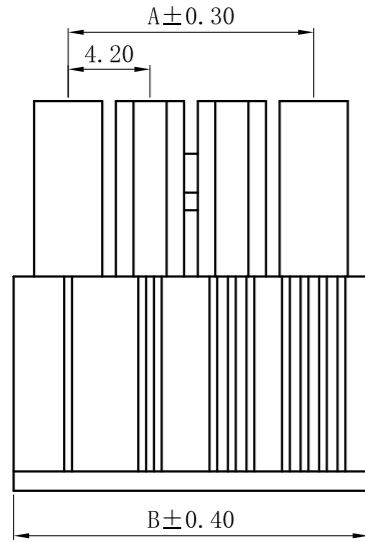
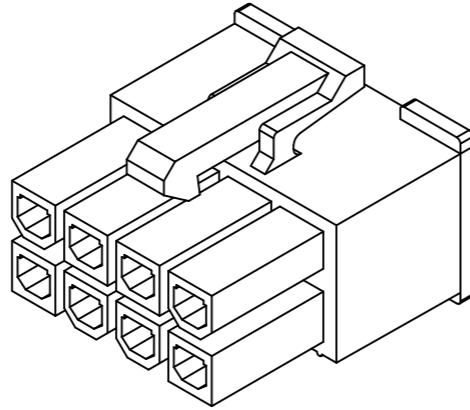
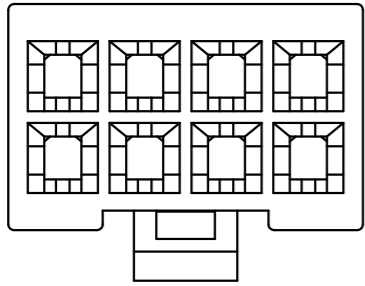

Table 1

Pin Code	Circuits	Dimensions(mm)		Pin Code	Circuits	Dimensions(mm)	
		A	B			A	B
22	4	/	5.60	2E	28	25.2	30.8
24	8	4.20	9.80	2G	32	29.4	35.0
26	12	8.40	14.0	2J	36	33.6	39.2
28	16	12.6	18.2	2L	40	37.8	43.4
2A	20	16.8	22.4	2N	44	42.0	47.6
2C	24	21.0	26.6	2Q	48	46.2	51.8

TOLERANCES:
 X. = ±0.35
 X.X = ±0.25
 X.XX = ±0.15
 GENERAL ANGLE
 X° = ±2°
 X.X° = ±1°
 X.XX° = ±0.5°

	www.i-ncp.com
PART NO: IPCW420H xx 1AV	NAME: 4.2mm PH 2xnPin Connector Housings Male
DRAWING NO IPCW420H1AV	UNITS:mm SCALE:1:1 REV.01
SHEET 1 OF 1	

Engineer Drawing

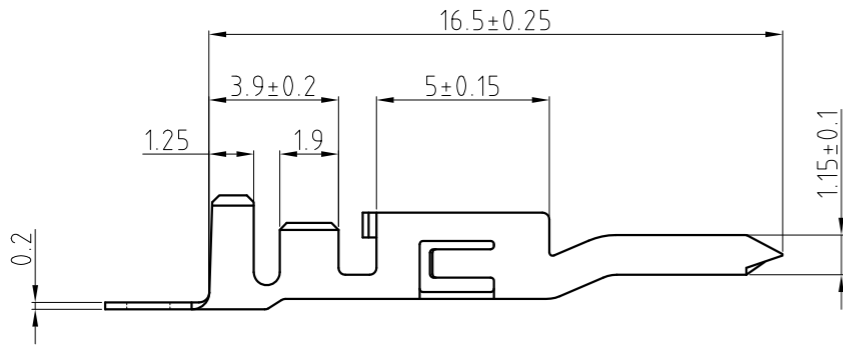

C向

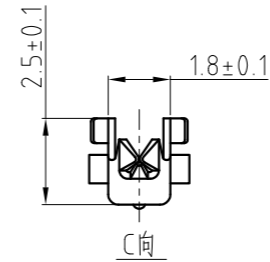
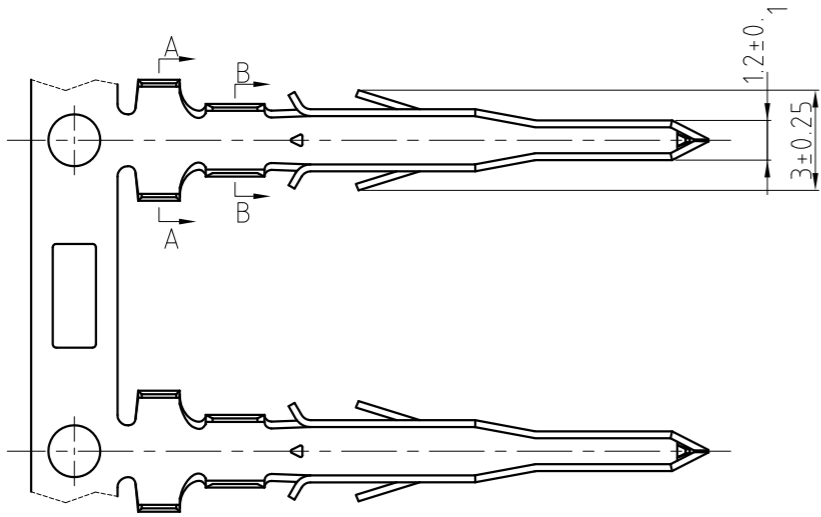
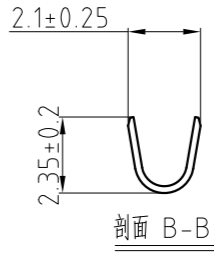
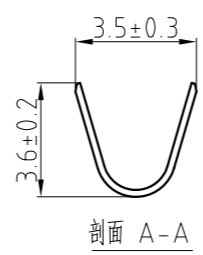

SPECIFICATIONS:

1. Applicable: AWG #16~#20
2. Voltage Rating: 250V AC/DC
3. Current Rating: 9.0A
5. Withstand Voltage: 1500V AC
6. Working Temperature: -25°C ~ +85°C
7. Insulation Resistance: ≥1000MΩ(Min)
8. Contact Resistance: ≤0.02 Ω(Max)
9. Material: Brass/Phosphor Bronze 0.2mm
10. Contact Area Plating: Tin-Plated

IPCW 420 T 01 X X X X X

- | | | | | | | | | |
|-----------------|---|---|---|-------------------------------|---|---|---|---|
| ① | ② | ③ | ④ | ⑤ | ⑥ | ⑦ | ⑧ | ⑨ |
| ①Series Type | | | | ⑤Material Code | | | | |
| ②Pitch:4.20mm | | | | ⑥Other Code | | | | |
| ③Connector Type | | | | ⑦Terminal Typ:M:Male F:Female | | | | |
| ④Serial Code | | | | ⑧Other Code | | | | |
| | | | | ⑨Plating:T=Tin | | | | |

TOLERANCES:
 <10:±0.20
 10~30:±0.25
 >10:±0.45
 GENERAL ANGLE
 X°=±3°
 X.X°=±0.5°

	www.i-ncp.com
PART NO: IPCW420T01 xx M	NAME: 4.2mmPH Crimp Terminal Male AWG #16~#20
DRAWING NO IPCW420T01MA	
SHEET 1 OF 1	UNITS:mm SCALE:1:1 REV.01

Engineer Drawing

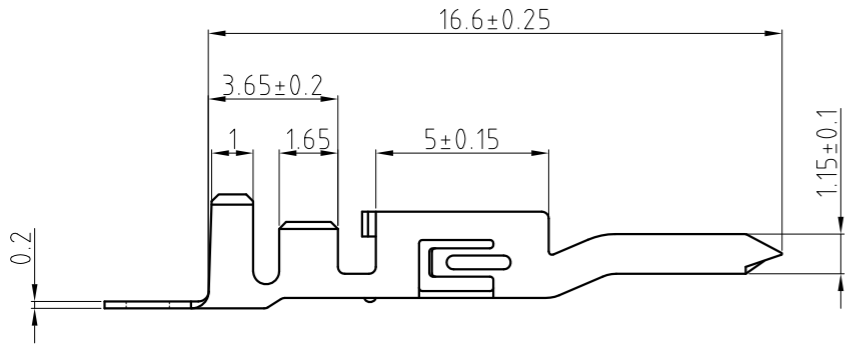

C向

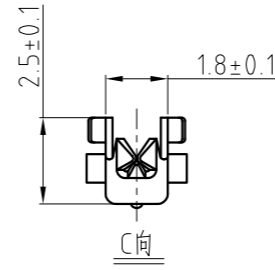
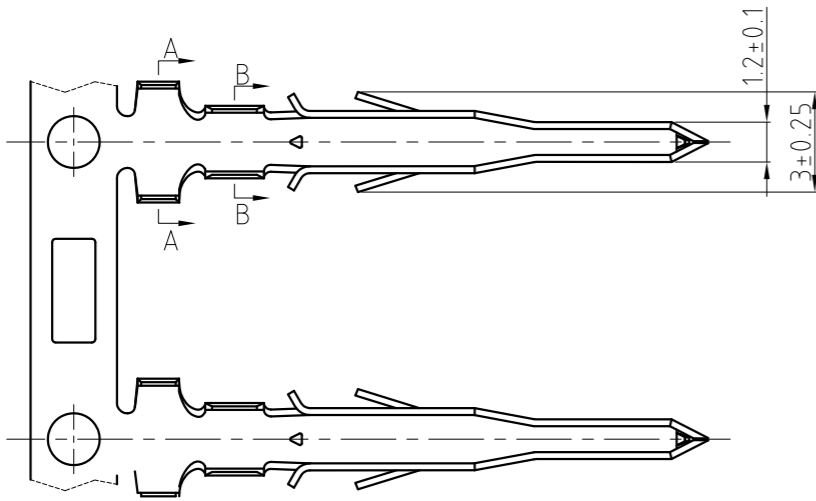
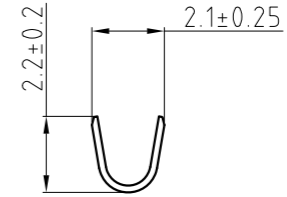
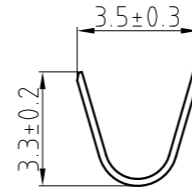

SPECIFICATIONS:

1. Applicable: AWG #18~#24
2. Voltage Rating: 250V AC/DC
3. Current Rating: 5.0A
5. Withstand Voltage: 1500V AC
6. Working Temperature: -25°C ~ +85°C
7. Insulation Resistance: ≥ 1000MΩ (Min)
8. Contact Resistance: ≤ 0.02 Ω (Max)
9. Material: Brass/Phosphor Bronze 0.2mm
10. Contact Area Plating: Tin-Plated

IPCW 420 T 02 X X X X X

- | | |
|------------------|-----------------------------------|
| ① Series Type | ⑤ Material Code |
| ② Pitch: 4.20mm | ⑥ Other Code |
| ③ Connector Type | ⑦ Terminal Typ: M: Male F: Female |
| ④ Serial Code | ⑧ Other Code |
| | ⑨ Plating: T= Tin |

TOLERANCES: <10:±0.20 10~30:±0.25 >10:±0.45 GENERAL ANGLE X°=±3° X.X°=±0.5°		www.i-ncp.com	
	PART NO: IPCW420T02 xx M	NAME: 4.2mmPH Crimp Terminal Male AWG #18~#24	
	DRAWING NO IPCW420T02MA		
	SHEET 1 OF 1	UNITS:mm SCALE:1:1 REV.01	

Engineer Drawing

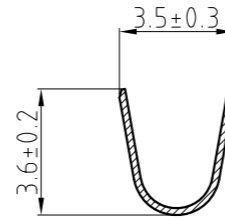
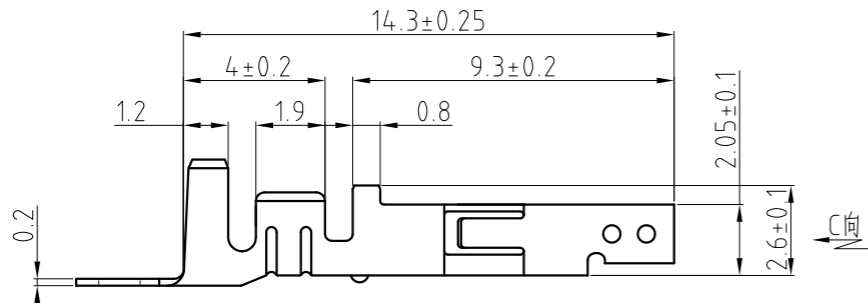

剖面 A-A

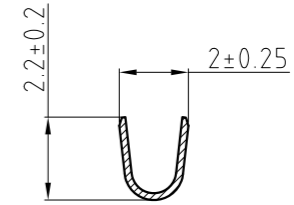

剖面 B-B

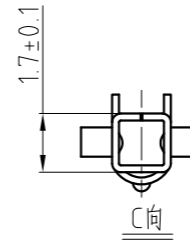
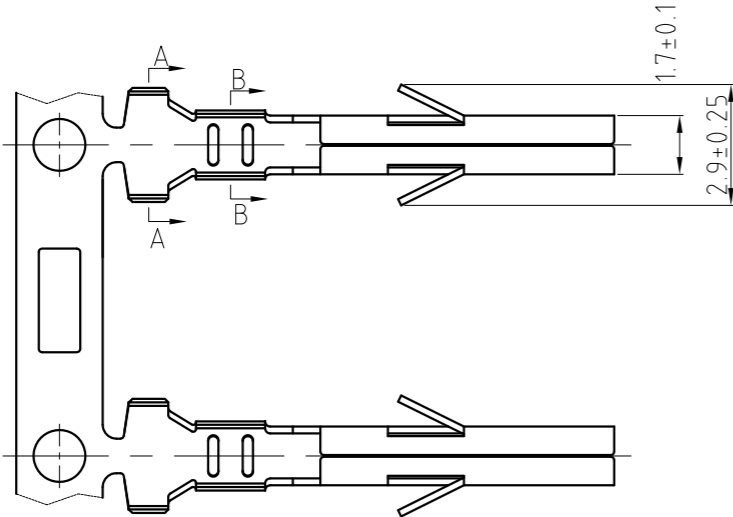

SPECIFICATIONS:

1. Applicable: AWG #16~#20
2. Voltage Rating: 250V AC/DC
3. Current Rating: 9.0A
5. Withstand Voltage: 1500V AC
6. Working Temperature: -25°C ~ +85°C
7. Insulation Resistance: ≥1000MΩ(Min)
8. Contact Resistance: ≤0.02 Ω(Max)
9. Material: Brass/Phosphor Bronze 0.2mm
10. Contact Area Plating: Tin-Plated

IPCW 420 T 01 X X X X X

- | | |
|------------------|-----------------------------------|
| ① Series Type | ⑤ Material Code |
| ② Pitch: 4.20mm | ⑥ Other Code |
| ③ Connector Type | ⑦ Terminal Typ: M: Male F: Female |
| ④ Serial Code | ⑧ Other Code |
| | ⑨ Plating: T= Tin |

TOLERANCES: <10:±0.20 10~30:±0.25 >10:±0.45 GENERAL ANGLE X°=±3° X.X°=±0.5°	NCP	www.i-ncp.com
	PART NO: IPCW420T01 xx F	NAME: 4.2mmPH Crimp Terminal Female AWG #16~#20
	DRAWING NO IPCW420T01FA	
	SHEET 1 OF 1 UNITS:mm SCALE:1:1 REV.01	

Engineer Drawing

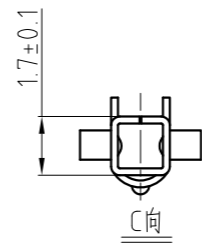
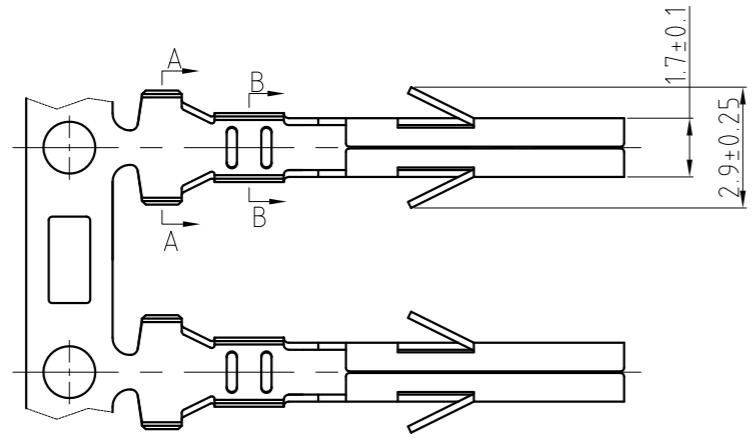
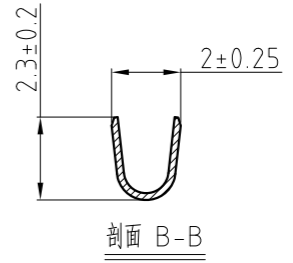
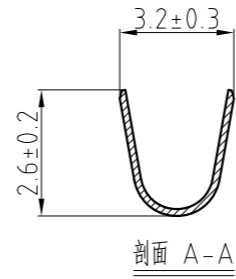
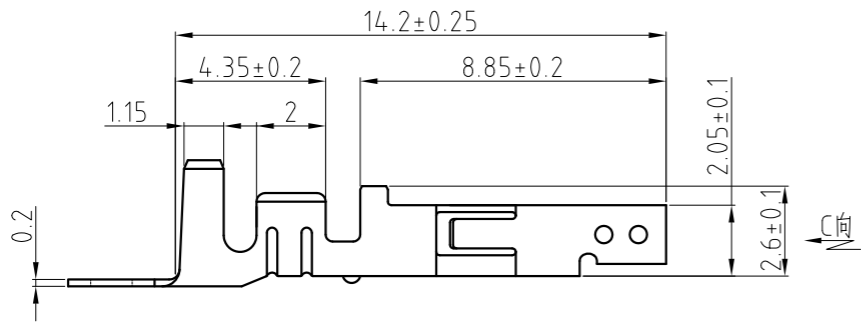

SPECIFICATIONS:

1. Applicable: AWG #18~#24
2. Voltage Rating: 250V AC/DC
3. Current Rating: 5.0A
5. Withstand Voltage: 1500V AC
6. Working Temperature: -25°C ~ +85°C
7. Insulation Resistance: ≥ 1000MΩ (Min)
8. Contact Resistance: ≤ 0.02 Ω (Max)
9. Material: Brass/Phosphor Bronze 0.2mm
10. Contact Area Plating: Tin-Plated

IPCW 420 T 02 X X X X X

- | | |
|------------------|-----------------------------------|
| ① Series Type | ⑤ Material Code |
| ② Pitch: 4.20mm | ⑥ Other Code |
| ③ Connector Type | ⑦ Terminal Typ: M: Male F: Female |
| ④ Serial Code | ⑧ Other Code |
| | ⑨ Plating: T= Tin |

TOLERANCES: <10:±0.20 10~30:±0.25 >10:±0.45 GENERAL ANGLE X°=±3° X.X°=±0.5°	NCP	www.i-ncp.com
	PART NO: IPCW420T02 xx F	NAME: 4.2mmPH Crimp Terminal Female AWG #18~#24
	DRAWING NO IPCW420T02FA	
	SHEET 1 OF 1	UNITS:mm SCALE:1:1 REV:01

X-ON Electronics

Largest Supplier of Electrical and Electronic Components

Click to view similar products for [Headers & Wire Housings](#) category:

Click to view products by [INCP](#) manufacturer:

Other Similar products are found below :

[0015917161](#) [0022155065](#) [57102-F02-18ULF](#) [58102-G61-06LF](#) [582553-1](#) [01.001.5753.1](#) [0050291907](#) [02.125.8002.8](#) [609-3404](#) [61062-3](#)
[CSU011177004](#) [622-0430](#) [622-3653LF](#) [63453-116](#) [636-1030](#) [636-1427](#) [636-3427](#) [636-4007](#) [641938-9](#) [65495-038](#) [65692-001LF](#) [65781-018](#)
[65781-047](#) [65817-010LF](#) [65817-015LF](#) [67095-007LF](#) [67601157](#) [68631-112](#) [699319-000](#) [70.362.1628.0](#) [70-4210](#) [70-4226B](#) [70-4853B](#) [707-](#)
[5028](#) [71.350.2428.0](#) [733-134](#) [733-162](#) [760-3052](#) [MHR-64-VUAL](#) [80.063.4001.1](#) [800-90-001-10-001000](#) [801-43-002-10-013000](#)
[801-43-006-10-002000](#) [803-43-024-10-001000](#) [803-93-012-10-001000](#) [8-1437020-4](#) [819-22-004-30-001101](#) [820-22-006-30-001101](#)
[820-22-008-30-001101](#) [821-22-002-10-001101](#)