

Engineer Drawing

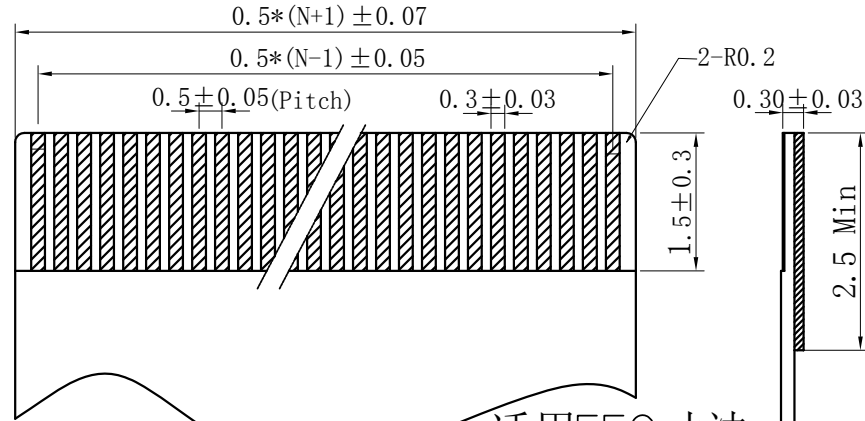

适用FFC寸法
APPLICABLE FFC

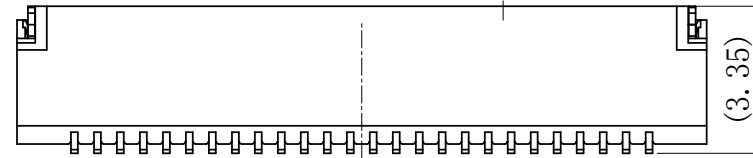
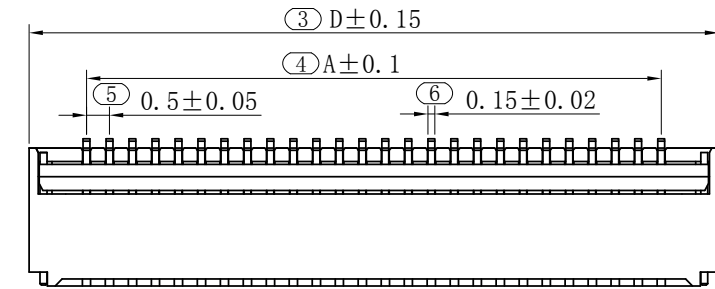
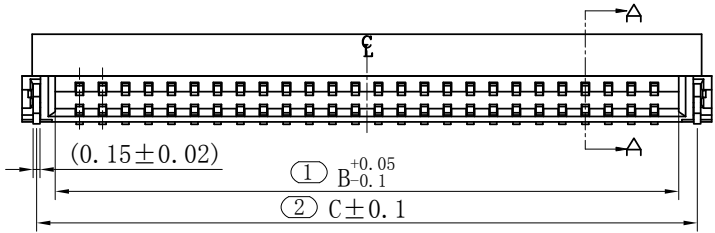
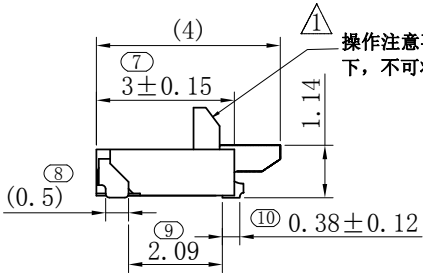

操作注意事项：在未插入排线前提示下，不可将锁扣压合至加锁状态。

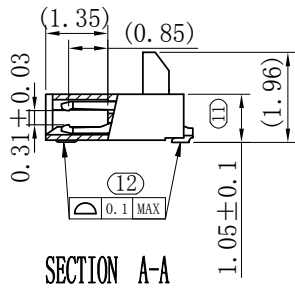

NOTES:

1. MATERIAL SEE TABLE;
2. PLATING SEE TABLE;
3. RATING
- 3-1. OPERATING TEMPERATURE: -40~85°C
- 3-2. OPERATING VOLTAGE: 50V AC/DC
- 3-3. CURRENT RATING: 0.5 AMPS
- 3-4. DIELECTRIC WITHSTANDING VOLTAGE: 500V AC/Minute;
- 3-5. INSULATION RESISTANCE: 500MΩ Min ;
- 3-6. CONTACT RESISTANCE: 0.04Ω Max;
4. N:孔位

IPFP051A3 ** * * * *

① ② ③ ④ ⑤ ⑥

- | | |
|---------------|-----------------|
| ① Series Type | ④ Company code. |
| ② Pin code. | ⑤ Packing |
| ③ Plating | ⑥ Lead Free HF |

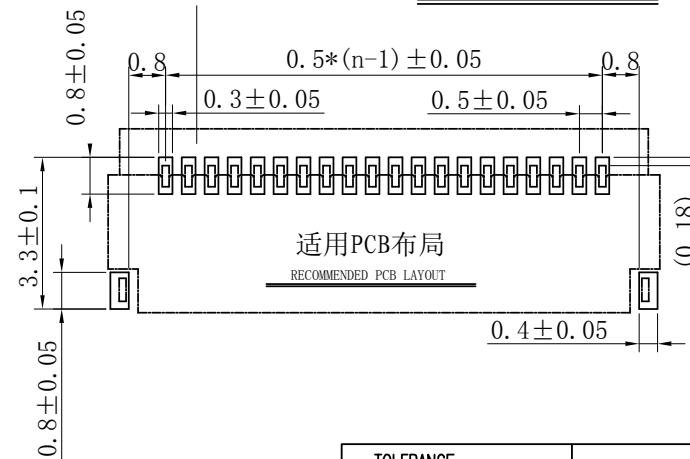

适用PCB布局
RECOMMENDED PCB LAYOUT

CKT	Dim A	Dim B	Dim C	Dim D
4	1.5	2.55	3.36	4.1
6	2.5	3.55	4.36	5.1
8	3.5	4.55	5.36	6.1
10	4.5	5.55	6.36	7.1
12	5.5	6.55	7.36	8.1
13	6	7.05	7.86	8.6
14	6.5	7.55	8.36	9.1
16	7.5	8.55	9.36	10.1
18	8.5	9.55	10.36	11.1
20	9.5	10.55	11.36	12.1
24	11.5	12.55	13.36	14.1
26	12.5	13.55	14.36	15.1
30	14.5	15.55	16.36	17.1
33	16	17.05	17.86	18.6
40	19.5	20.55	21.36	22.1

<p>TOLERANCE</p> <p>0.X ±0.25 X° ±3°</p> <p>0.XX ±0.12</p> <p>0.XXX ±0.05 X.X° ±0.5°</p> <p>UNLESS OTHERWISE SPECIFIED</p>			www.i-ncp.com	
	PART NO.		TITLE:	
	IPFP051A3 xx		0.5 FPC CONN ZIF SMT BACKFLIP	
	DRAWING NO.		H=1.05 LOWER CONTACT	
IPFP051A3		SHEET 1 OF 1		UNITS mm
		SCALE 1:1		REV. 01

X-ON Electronics

Largest Supplier of Electrical and Electronic Components

Click to view similar products for [FFC & FPC Connectors](#) category:

Click to view products by [INCP](#) manufacturer:

Other Similar products are found below :

[00-6200-227-022-800](#) [006205250500825+](#) [006205280500825+](#) [FPH-1602G](#) [52610-1275](#) [501864-3091-TR225](#) [086222026001800](#) [52610-0675](#) [62674-201121DLF](#) [62684-36210E9ALF](#) [52746-1671-TR250](#) [10051922-2810EHLF](#) [686322124422](#) [XF3M-2915-1B-R100](#) [AYF353125A](#) [AYF530665TA](#) [AYF534065TA](#) [20FLH-RSM1-TB](#) [AYF351525](#) [086212040340800+](#) [AYF530365TA](#) [67000-004LF](#) [006207341915000+](#) [207356-1](#) [67000-003LF](#) [HFW14R-2STE9LF](#) [SFW12R-5STE9LF](#) [SFW18R-1STAE9LF](#) [SFW4R-5STE9LF](#) [52807-0430](#) [046283021002868+](#) [502250-8027](#) [104267-9617](#) [66987-011LF](#) [HFW8S-2STAE1HLF](#) [67000-008LF](#) [HFW22R-2STE1H1LF](#) [0781271110](#) [0781272410](#) [0781272810](#) [5019511030](#) [FH28K-40S-0.5SH](#) [200528-0260](#) [5039084120](#) [503908-5120](#) [SFW20R-1STGE5LF](#) [FH12-18S-0.5SH](#) [686116183522](#) [686114183522](#) [502078-5362](#)