

Engineer Drawing

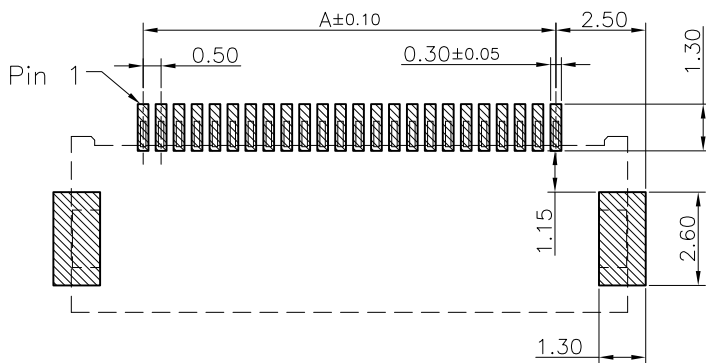

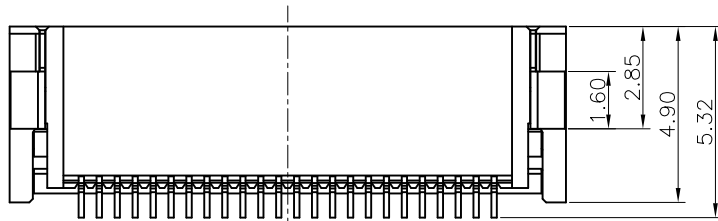
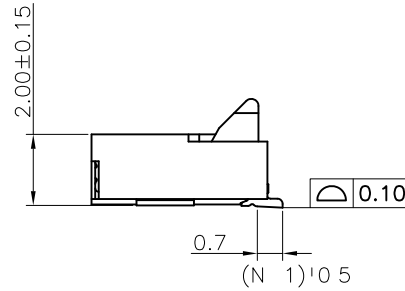
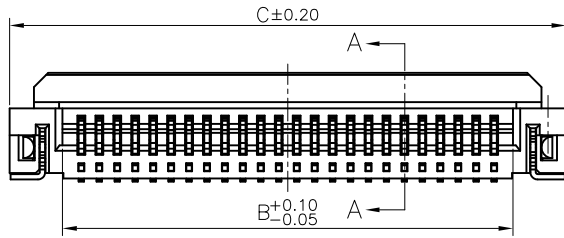
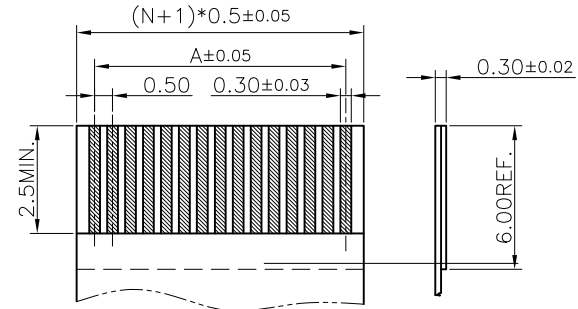
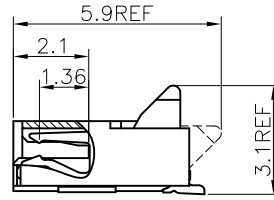
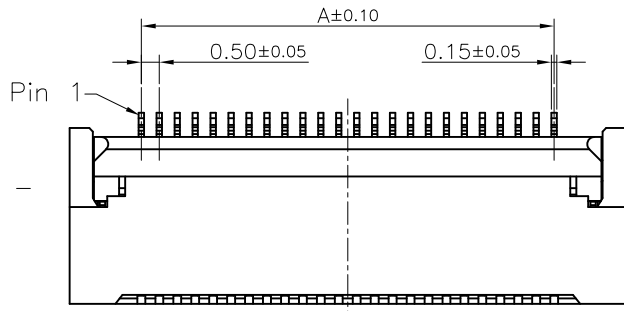

NOTES:

- MATERIAL:**
HOUSING: HIGHT-TEMP PLASTIC,UL 94-V0,COLOR:NATURE;
COVER: HIGHT-TEMP PLASTIC,UL 94-V0,COLOR:BLACK;
CONTACT: COPPER ALLOY;
LEG: COPPER ALLOY;
- PLATING:**
CONTACT AND SOLDER AREA GOLD FLASH PLATED ON NICKEL OVER ALL.
LEG: TIN PLATED ON NICKEL OVER ALL.
- RATING:**
CURRENT RATING: 0.5A AC/DC
VOLTAGE RATING: 50V AC/DC
TEMPERATURE RANGE: -40°C~+85°C;
- PART NO:**

IPFP05202 ** * * * *

- ① Series Type ④ Company code.
② Pin code. ⑤ Packing
③ Plating ⑥ Lead Free HF

| CKTS | DIM A | DIM B | DIM C | CKTS | DIM A | DIM B | DIM C |
|------|-------|-------|-------|------|-------|-------|-------|
| 4 | 1.50 | 2.55 | 5.50 | 33 | 16.00 | 17.05 | 20.00 |
| 5 | 2.00 | 3.05 | 6.00 | 34 | 16.50 | 17.55 | 20.50 |
| 6 | 2.50 | 3.55 | 6.50 | 35 | 17.00 | 18.05 | 21.00 |
| 7 | 3.00 | 4.05 | 7.00 | 36 | 17.50 | 18.55 | 21.50 |
| 8 | 3.50 | 4.55 | 7.50 | 37 | 18.00 | 19.05 | 22.00 |
| 9 | 4.00 | 5.05 | 8.00 | 38 | 18.50 | 19.55 | 22.50 |
| 10 | 4.50 | 5.55 | 8.50 | 39 | 19.00 | 20.05 | 23.00 |
| 11 | 5.00 | 6.05 | 9.00 | 40 | 19.50 | 20.55 | 23.50 |
| 12 | 5.50 | 6.55 | 9.50 | 41 | 20.00 | 21.05 | 24.00 |
| 13 | 6.00 | 7.05 | 10.00 | 42 | 20.50 | 21.55 | 24.50 |
| 14 | 6.50 | 7.55 | 10.50 | 43 | 21.00 | 22.05 | 25.00 |
| 15 | 7.00 | 8.05 | 11.00 | 44 | 21.50 | 22.55 | 25.50 |
| 16 | 7.50 | 8.55 | 11.50 | 45 | 22.00 | 23.05 | 26.00 |
| 17 | 8.00 | 9.05 | 12.00 | 46 | 22.50 | 23.55 | 26.50 |
| 18 | 8.50 | 9.55 | 12.50 | 47 | 23.00 | 24.05 | 27.00 |
| 19 | 9.00 | 10.05 | 13.00 | 48 | 23.50 | 24.55 | 27.50 |
| 20 | 9.50 | 10.55 | 13.50 | 49 | 24.00 | 25.05 | 28.00 |
| 21 | 10.00 | 11.05 | 14.00 | 50 | 24.50 | 25.55 | 28.50 |
| 22 | 10.50 | 11.55 | 14.50 | 51 | 25.00 | 26.05 | 29.00 |
| 23 | 11.00 | 12.05 | 15.00 | 52 | 25.50 | 26.55 | 29.50 |
| 24 | 11.50 | 12.55 | 15.50 | 53 | 26.00 | 27.05 | 30.00 |
| 25 | 12.00 | 13.05 | 16.00 | 54 | 26.50 | 27.55 | 30.50 |
| 26 | 12.50 | 13.55 | 16.50 | 55 | 27.00 | 28.05 | 31.00 |
| 27 | 13.00 | 14.05 | 17.00 | 56 | 27.50 | 28.55 | 31.50 |
| 28 | 13.50 | 14.55 | 17.50 | 57 | 28.00 | 29.05 | 32.00 |
| 29 | 14.00 | 15.05 | 18.00 | 58 | 28.50 | 29.55 | 32.50 |
| 30 | 14.50 | 15.55 | 18.50 | 59 | 29.00 | 30.05 | 33.00 |
| 31 | 15.00 | 16.05 | 19.00 | 60 | 29.50 | 30.55 | 33.50 |
| 32 | 15.50 | 16.55 | 19.50 | | | | |

| | | | | | |
|---|---|--|--|-----------|---------|
| TOLERANCE X ±0.5 XX ±0.15 X ±0.25 XXX ±0.1 ANGLES ±2° |  | | www.i-ncp.com | | |
| | PART NO. IPFP05202 xx | | TITLE: 0.5 FPC CONN ZIF SMT Easy-on | | |
| | DRAWING NO. IPFP05202 | | H=2.0 | | |
| UNLESS OTHERWISE SPECIFIED | |  SHEET 1 OF 1 | UNITS mm | SCALE 1:1 | REV. 01 |

X-ON Electronics

Largest Supplier of Electrical and Electronic Components

Click to view similar products for [FFC & FPC Connectors](#) category:

Click to view products by [INCP](#) manufacturer:

Other Similar products are found below :

[00-6200-227-022-800](#) [006205250500825+](#) [006205280500825+](#) [FPH-1602G](#) [086222026001800](#) [52610-0675](#) [62674-201121DLF](#) [52746-1671-TR250](#) [10051922-1610EHLF](#) [10051922-2810EHLF](#) [686322124422](#) [XF3M-2915-1B-R100](#) [AYF353125A](#) [AYF530665TA](#) [AYF534065TA](#) [20FLH-RSM1-TB](#) [207356-1](#) [SFW12R-5STE9LF](#) [SFW18R-1STAE9LF](#) [SFW4R-5STE9LF](#) [52807-0430](#) [046283021002868+](#) [FFC05011-10SBB114W5M](#) [502250-8027](#) [67000-008LF](#) [200528-0260](#) [FH28K-10S-0.5SH](#) [FH52K-6S-0.5SH](#) [0.5K-DX-30PWB](#) [DS1020-08-10VBT12](#) [THD0515-34CL-GF](#) [X05A10L28G](#) [ECC2841061EU](#) [1.0K-DHQX-16PWB](#) [1.0K-DHQX-30PWB](#) [1775333-6](#) [10054365-202110ELF](#) [10054365-242110ELF](#) [10054365-282110ELF](#) [10064555-392220HLF](#) [59453-041110EBHLF](#) [59453-091110EDHLF](#) [62674-241141ALF](#) [62684-432100ALF](#) [62684-451100AHLF](#) [62684-5721N0ALF](#) [HFW11R-1STE1MTLF](#) [HFW12R-1STE9LF](#) [HFW14R-1STE9MTLF](#) [HFW18S-2STE9LF](#)