

# TK 1818 – Polystyrene and Polycarbonate – 182 x 180 mm (7.17 x 7.09 in.)

## Standard Features

- **Protection Level:** IP66 (NEMA Type: 4X with gray cover, 12K with transparent cover)
- **Technical:** Smooth or Knockout Sidewalls  
Gray or Tinted Transparent Cover  
Multiple Enclosure Mounting Options
- **UL Recognized**  
**Enclosure Materials:** Polystyrene or Polycarbonate
- **Gasket Material:** Polyurethane
- **Color:** Light Gray
- **Material**  
**Temperature Range:** Polystyrene  
-40°C to 70°C (-40°F to 158°F)  
Polycarbonate  
-40°C to 120°C (-40°F to 248°F)
- **Accessories:** See section below



### Smooth Sidewalls

Ordering Information	Height mm (in)	Polystyrene				Polycarbonate			
		Cat. No.	Type	Cover Color	Std. Pk.	Cat. No.	Type	Cover Color	Std. Pk.
☐ Enclosure - low cover	90 mm (3.54 in)	110-407	PS 1818-9-o	gray	2	120-407	PC 1818-9-o	gray	2
☐ Enclosure - high cover	111 mm (4.37 in)	110-907	PS 1818-11-o	gray	2	120-907	PC 1818-11-o	gray	2
☐ Enclosure - top hat cover	165 mm (6.50 in)	109-407	PS 1818-16-o	gray	1	121-407	PC 1818-16-o	gray	1
☐ Enclosure - low cover	90 mm (3.54 in)	111-007	PS 1818-9-to	trans.	2	130-007	PC 1818-9-to	trans.	2
☐ Enclosure - high cover	111 mm (4.37 in)	111-507	PS 1818-11-to	trans.	2	130-507	PC 1818-11-to	trans.	2
☐ Enclosure - top hat cover	165 mm (6.50 in)	112-007	PS 1818-16-to	trans.	1	131-007	PC 1818-16-to	trans.	1

### Sidewalls with Metric Knockouts

Ordering Information	Height mm (in)	Polystyrene				Polycarbonate			
		Cat. No.	Type	Cover Color	Std. Pk.	Cat. No.	Type	Cover Color	Std. Pk.
☐ Enclosure - low cover	90 mm (3.54 in)	105-407	PS 1818-9-m	gray	2	127-407	PC 1818-9-m	gray	2
☐ Enclosure - high cover	111 mm (4.37 in)	105-907	PS 1818-11-m	gray	2	127-907	PC 1818-11-m	gray	2
☐ Enclosure - top hat cover	165 mm (6.50 in)	104-407	PS 1818-16-m	gray	1	128-407	PC 1818-16-m	gray	1
☐ Enclosure - low cover	90 mm (3.54 in)	106-007	PS 1818-9-tm	trans.	2	137-007	PC 1818-9-tm	trans.	2
☐ Enclosure - high cover	111 mm (4.37 in)	106-507	PS 1818-11-tm	trans.	2	137-507	PC 1818-11-tm	trans.	2
☐ Enclosure - top hat cover	165 mm (6.50 in)	107-007	PS 1818-16-tm	trans.	1	138-007	PC 1818-16-tm	trans.	1

### Accessories

Ordering Information	Cat. No.	Type	Std. Pk.
Mounting Plate (plastic)	195-007	TKMPI-1818	1
Mounting Plate (steel)	197-007	TKMPS-1818	1
DIN Rail TS35-144mm	198-144	TS 35/144	1
Hinge Kit Set	190-005	HK2	1
Mounting Tab Kit	194-001	MT1	1

Please refer to pages 149-152 for additional accessories and detailed information.

Dimensions

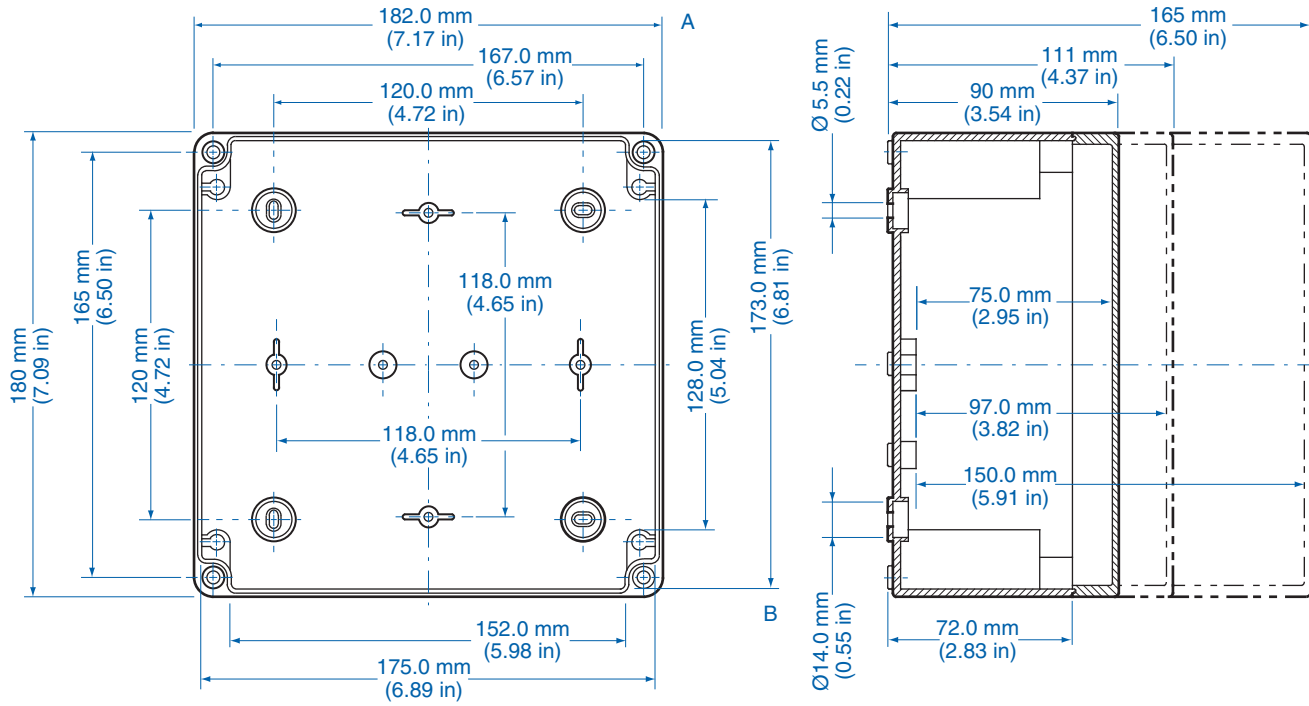

Knockout Positions

Side A

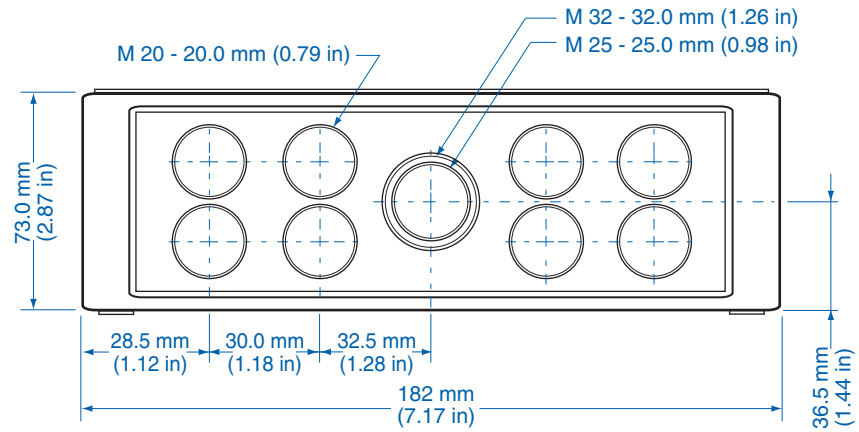

Side B

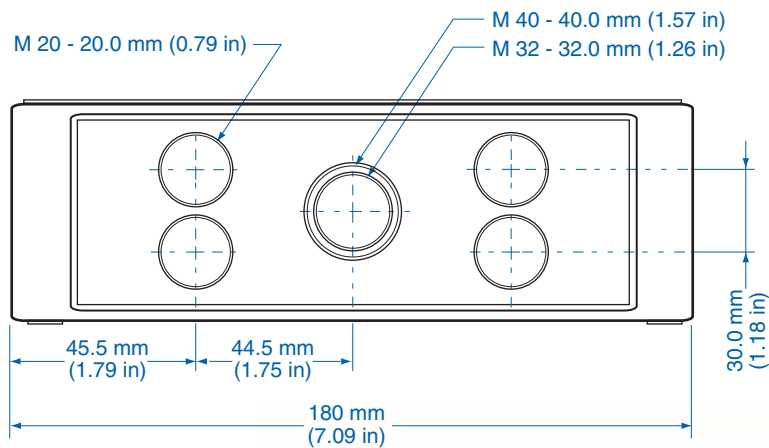

## X-ON Electronics

Largest Supplier of Electrical and Electronic Components

*Click to view similar products for [Enclosures, Boxes, & Cases](#) category:*

*Click to view products by [Altech](#) manufacturer:*

Other Similar products are found below :

[CR-425 PAINTED](#) [585-R-WH-PK](#) [M-10-PLATED](#) [60221-01](#) [60566-01-000](#) [HPL-9VB BATT DOOR](#) [M-16-LID-PLATED](#) [M18-PLTD](#) [M-21-LID-PLATED](#) [M-21-PLATED](#) [M-23-PLATED](#) [CU-281-MB](#) [6711GSKT](#) [71884-29-028](#) [LH45-100 Black](#) [7200B](#) [72868-510-000](#) [CNS-0000 Black](#) [72883-510-000](#) [CNS-0101 Black](#) [72906-510-000](#) [CNS-0407 Black](#) [73091-510-000](#) [CNM-0000-BLACK Kit](#) [73092-510-000](#) [CNM-0101 Black](#) [73108-510-000](#) [CNL-0303 Black](#) [73395-510-039](#) [CNS-0006 Bone](#) [74257-510-000](#) [CNL-0004](#) [MDC-1183-PLAIN-ALUM](#) [MDC-1183-PTD](#) [MDC-13104-PLAIN-ALUM](#) [MDC-211 - PAINTED IVORY/BEIGE](#) [MDC-321-PTD](#) [MDC-432-PLAIN-ALUM](#) [MDC-973-PTD](#) [76](#) [77153-01-028](#) [FLX6030](#) [83535-01-508](#) [PS-11296-G](#) [PS-11298-B](#) [116-508](#) [120-407](#) [120-412](#) [120-909](#) [120-455](#) [R272-100-000](#) [120-910](#) [R501-001-010](#) [R508-080-000](#) [R508-160-000](#) [R530-120-000](#) [R530-122-000](#) [R530-200-000](#) [R531-160-000](#) [R531-200-000](#) [R582-080-100](#)