

## Final datasheet

### CoolSiC™ 1200 V SiC Trench MOSFET : Silicon Carbide MOSFET

#### Features

- $V_{DS} = 1200\text{ V}$  at  $T_{vj} = -55...175^\circ\text{C}$
- $I_{DC} = 38\text{ A}$  at  $T_C = 25^\circ\text{C}$
- $R_{DS(on)} = 60\text{ m}\Omega$  at  $V_{GS} = 20\text{ V}$ ,  $T_{vj} = 25^\circ\text{C}$
- New performance-optimized chip technology (Gen1p) with improved  $R_{DS(on)}^* \text{ A}$
- Best in class switching energy for lower switching losses and reduced cooling efforts
- Lowest device capacitances for higher switching speeds and higher power density
- A combination of low  $C_{rss}/C_{iss}$  ratio and high  $V_{GS(th)}$  to avoid parasitic turn-on and enable unipolar gate driving
- Reduced total gate charge  $Q_G$  for lower driving power and losses
- Increased recommended turn-on voltage ( $V_{GS(on)} = 20\text{ V}$ ) for lower  $R_{DS(on)}$
- .XT die attach technology for best in class thermal performance
- Low package stray inductance for faster and cleaner switching
- Sense (Kelvin) source pin for better gate control and reduced switching losses
- Minimal creepage distance 5.85 mm (material group II) to fit 800 V applications without coating
- SMT package for automated assembly and reduced system costs

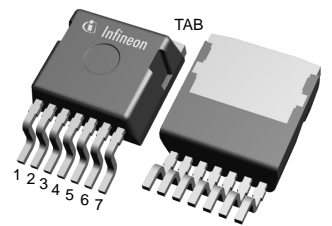

#### Potential applications

- On-board charger
- DC/DC converter
- Auxiliary drives

#### Product validation

- Qualified for Automotive Applications. Product Validation according to AEC-Q100/101

#### Description

Pin definition:

- Pin 1 - Gate
- Pin 2 - Kelvin sense contact
- Pin 3...7 - Source
- Tab - Drain

Note: The source and sense pins are not exchangeable, their exchange might lead to malfunction

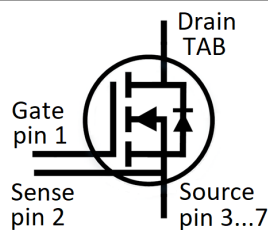

Type	Package	Marking
AIMBG120R060M1	PG-TO263-7-HV-ND5.8	AS60MM1

## Table of contents

	<b>Description</b> .....	1
	<b>Features</b> .....	1
	<b>Potential applications</b> .....	1
	<b>Product validation</b> .....	1
	<b>Table of contents</b> .....	2
<b>1</b>	<b>Package</b> .....	3
<b>2</b>	<b>MOSFET</b> .....	3
<b>3</b>	<b>Body diode (MOSFET)</b> .....	5
<b>4</b>	<b>Characteristics diagrams</b> .....	7
<b>5</b>	<b>Package outlines</b> .....	13
<b>6</b>	<b>Testing conditions</b> .....	14
	<b>Revision history</b> .....	15
	<b>Disclaimer</b> .....	16

1 Package

## 1 Package

**Table 1** Characteristic values

Parameter	Symbol	Note or test condition	Values			Unit
			Min.	Typ.	Max.	
Storage temperature	$T_{stg}$		-55		150	°C
Soldering temperature	$T_{sold}$				260	°C
MOSFET/body diode thermal resistance, junction-case <sup>1)</sup>	$R_{th(j-c)}$			0.57	0.74	K/W

1) not subject to production test - verified by design/characterization

## 2 MOSFET

**Table 2** Maximum rated values

Parameter	Symbol	Note or test condition	Values	Unit	
Drain-source voltage <sup>1)</sup>	$V_{DSS}$	$T_{vj} = -55...175\text{ °C}$	1200	V	
Continuous DC drain current for $R_{th(j-c,max)}$ , limited by $T_{vj(max)}$ <sup>2)</sup>	$I_{DDC}$	$V_{GS} = 20\text{ V}$	$T_c = 25\text{ °C}$	38	A
			$T_c = 100\text{ °C}$	27	
Peak drain current, $t_p$ limited by $T_{vj(max)}$ <sup>2)</sup>	$I_{DM}$	$V_{GS} = 20\text{ V}$	97	A	
Gate-source voltage, max. transient voltage <sup>3)</sup>	$V_{GS}$	$t_p \leq 0.5\text{ }\mu\text{s}, D < 0.01$	-10...25	V	
Gate-source voltage, max. static voltage <sup>3)</sup>	$V_{GS}$		-5...23	V	
Avalanche energy, single pulse	$E_{AS}$	$I_D = 10\text{ A}, V_{DD} = 50\text{ V}, L = 3.6\text{ mH}$	180	mJ	
Power dissipation, limited by $T_{vj(max)}$ <sup>2)</sup>	$P_{tot}$		$T_c = 25\text{ °C}$	202	W
			$T_c = 100\text{ °C}$	101	

1) Tested at  $T_{vj}=25\text{ °C}$ , verified by design/characterization over full temperature range

2) not subject to production test - verified by design/characterization

3) **Important note:** The selection of positive and negative gate-source voltages impacts the long-term behavior of the device. The design guidelines described in Application Note AN2018-09 must be considered to ensure sound operation of the device over the planned lifetime.

**Table 3** Recommended values

Parameter	Symbol	Note or test condition	Values	Unit
Recommended turn-on gate voltage	$V_{GS(on)}$		20	V
Recommended turn-off gate voltage	$V_{GS(off)}$		0	V

**Table 4** Characteristic values

Parameter	Symbol	Note or test condition	Values			Unit	
			Min.	Typ.	Max.		
Drain-source on-state resistance	$R_{DS(on)}$	$I_D = 13\text{ A}$	$T_{vj} = 25\text{ °C}$ , $V_{GS(on)} = 20\text{ V}$		60	75	mΩ
			$T_{vj} = 100\text{ °C}$ , $V_{GS(on)} = 20\text{ V}$		84		
			$T_{vj} = 175\text{ °C}$ , $V_{GS(on)} = 20\text{ V}$		120		
			$T_{vj} = 25\text{ °C}$ , $V_{GS(on)} = 18\text{ V}$		65		
Gate-source threshold voltage	$V_{GS(th)}$	$I_D = 4.3\text{ mA}$ , $V_{DS} = V_{GS}$ (tested after 1 ms pulse at $V_{GS} = 20\text{ V}$ )	$T_{vj} = 25\text{ °C}$	3.7	4.4	5.1	V
			$T_{vj} = 175\text{ °C}$		3.6		
Zero gate-voltage drain current	$I_{DSS}$	$V_{DS} = 1200\text{ V}$ , $V_{GS} = 0\text{ V}$	$T_{vj} = 25\text{ °C}$		0.3	13	μA
			$T_{vj} = 175\text{ °C}$		10		
Gate leakage current	$I_{GSS}$	$V_{DS} = 0\text{ V}$	$V_{GS} = 25\text{ V}$			100	nA
			$V_{GS} = -10\text{ V}$			-100	
Forward transconductance	$g_{fs}$	$I_D = 13\text{ A}$ , $V_{DS} = 20\text{ V}$		8.1		S	
Short-circuit withstand time <sup>1)</sup>	$t_{SC}$	$V_{DD} \leq 800\text{ V}$ , $V_{DS,peak} < 1200\text{ V}$ , $T_{vj(start)} = 25\text{ °C}$ , $R_{G,ext} = 2\text{ }\Omega$	$V_{GS(on)} = 20\text{ V}$		1.5		μs
			$V_{GS(on)} = 18\text{ V}$		2		
			$V_{GS(on)} = 15\text{ V}$		2.5		
Internal gate resistance	$R_{G,int}$	$f = 1\text{ MHz}$ , $V_{AC} = 25\text{ mV}$		4		Ω	
Input capacitance	$C_{iss}$	$V_{DD} = 800\text{ V}$ , $V_{GS} = 0\text{ V}$ , $f = 100\text{ kHz}$ , $V_{AC} = 25\text{ mV}$		880		pF	
Output capacitance	$C_{oss}$	$V_{DD} = 800\text{ V}$ , $V_{GS} = 0\text{ V}$ , $f = 100\text{ kHz}$ , $V_{AC} = 25\text{ mV}$		43		pF	
Reverse transfer capacitance	$C_{rss}$	$V_{DD} = 800\text{ V}$ , $V_{GS} = 0\text{ V}$ , $f = 100\text{ kHz}$ , $V_{AC} = 25\text{ mV}$		2		pF	
$C_{oss}$ stored energy	$E_{oss}$	$V_{DD} = 800\text{ V}$ , $V_{GS} = 0\text{ V}$ , $f = 100\text{ kHz}$ , $V_{AC} = 25\text{ mV}$		18		μJ	
Total gate charge	$Q_G$	$V_{DD} = 800\text{ V}$ , $I_D = 13\text{ A}$ , $V_{GS} = 0/20\text{ V}$ , turn-on pulse		32		nC	
Plateau gate charge	$Q_{GS(pl)}$	$V_{DD} = 800\text{ V}$ , $I_D = 13\text{ A}$ , $V_{GS} = 0/20\text{ V}$ , turn-on pulse		8		nC	
Gate-to-drain charge	$Q_{GD}$	$V_{DD} = 800\text{ V}$ , $I_D = 13\text{ A}$ , $V_{GS} = 0/20\text{ V}$ , turn-on pulse		5		nC	
Turn-on delay time	$t_{d(on)}$	$V_{DD} = 800\text{ V}$ , $I_D = 13\text{ A}$ , $V_{GS} = 0/20\text{ V}$ , $R_{G,ext} = 2\text{ }\Omega$ , $L_\sigma = 20\text{ nH}$ , diode: body diode at $V_{GS} = 0\text{ V}$	$T_{vj} = 25\text{ °C}$		6.2		ns
			$T_{vj} = 175\text{ °C}$		6.2		

(table continues...)

**Table 4** (continued) Characteristic values

Parameter	Symbol	Note or test condition	Values			Unit
			Min.	Typ.	Max.	
Rise time	$t_r$	$V_{DD} = 800 \text{ V}, I_D = 13 \text{ A}, V_{GS} = 0/20 \text{ V}, R_{G,ext} = 2 \Omega, L_\sigma = 20 \text{ nH},$ diode: body diode at $V_{GS} = 0 \text{ V}$	$T_{vj} = 25 \text{ }^\circ\text{C}$	5.4		ns
			$T_{vj} = 175 \text{ }^\circ\text{C}$	6.4		
Turn-off delay time	$t_{d(off)}$	$V_{DD} = 800 \text{ V}, I_D = 13 \text{ A}, V_{GS} = 0/20 \text{ V}, R_{G,ext} = 2 \Omega, L_\sigma = 20 \text{ nH},$ diode: body diode at $V_{GS} = 0 \text{ V}$	$T_{vj} = 25 \text{ }^\circ\text{C}$	13		ns
			$T_{vj} = 175 \text{ }^\circ\text{C}$	13.9		
Fall time	$t_f$	$V_{DD} = 800 \text{ V}, I_D = 13 \text{ A}, V_{GS} = 0/20 \text{ V}, R_{G,ext} = 2 \Omega, L_\sigma = 20 \text{ nH},$ diode: body diode at $V_{GS} = 0 \text{ V}$	$T_{vj} = 25 \text{ }^\circ\text{C}$	8		ns
			$T_{vj} = 175 \text{ }^\circ\text{C}$	8.5		
Turn-on energy	$E_{on}$	$V_{DD} = 800 \text{ V}, I_D = 13 \text{ A}, V_{GS} = 0/20 \text{ V}, R_{G,ext} = 2 \Omega, L_\sigma = 20 \text{ nH},$ diode: body diode at $V_{GS} = 0 \text{ V}$	$T_{vj} = 25 \text{ }^\circ\text{C}$	79.3		$\mu\text{J}$
			$T_{vj} = 175 \text{ }^\circ\text{C}$	113.3		
Turn-off energy	$E_{off}$	$V_{DD} = 800 \text{ V}, I_D = 13 \text{ A}, V_{GS} = 0/20 \text{ V}, R_{G,ext} = 2 \Omega, L_\sigma = 20 \text{ nH},$ diode: body diode at $V_{GS} = 0 \text{ V}$	$T_{vj} = 25 \text{ }^\circ\text{C}$	31.5		$\mu\text{J}$
			$T_{vj} = 175 \text{ }^\circ\text{C}$	30.7		
Total switching energy	$E_{tot}$	$V_{DD} = 800 \text{ V}, I_D = 13 \text{ A}, V_{GS} = 0/20 \text{ V}, R_{G,ext} = 2 \Omega, L_\sigma = 20 \text{ nH},$ diode: body diode at $V_{GS} = 0 \text{ V}$	$T_{vj} = 25 \text{ }^\circ\text{C}$	110.8		$\mu\text{J}$
			$T_{vj} = 175 \text{ }^\circ\text{C}$	144		
Virtual junction temperature	$T_{vj}$		-55		175	$^\circ\text{C}$

1) not subject to production test - verified by design/characterization

**Note:** Characteristics at  $T_{vj} = 25^\circ\text{C}$ , unless otherwise specified.

### 3 Body diode (MOSFET)

**Table 5** Maximum rated values

Parameter	Symbol	Note or test condition	Values	Unit	
Drain-source voltage <sup>1)</sup>	$V_{DSS}$	$T_{vj} = -55\dots175 \text{ }^\circ\text{C}$	1200	V	
Continuous reverse drain current for $R_{th(j-c,max)}$ , limited by $T_{vj(max)}$ <sup>2)</sup>	$I_{SDC}$	$V_{GS} = 0 \text{ V}$	$T_c = 25 \text{ }^\circ\text{C}$	30	A
			$T_c = 100 \text{ }^\circ\text{C}$	21	
Peak reverse drain current, $t_p$ limited by $T_{vj(max)}$ <sup>2)</sup>	$I_{SM}$	$V_{GS} = 0 \text{ V}$	30	A	

1) Tested at  $T_{vj}=25^\circ\text{C}$ , verified by design/characterization over full temperature range

**3 Body diode (MOSFET)**

2) not subject to production test - verified by design/characterization

**Table 6 Characteristic values**

Parameter	Symbol	Note or test condition	Values			Unit
			Min.	Typ.	Max.	
Drain-source reverse voltage	$V_{SD}$	$I_{SD} = 13 \text{ A}, V_{GS} = 0 \text{ V}$	$T_{vj} = 25 \text{ °C}$	3.9	5	V
			$T_{vj} = 100 \text{ °C}$	3.8		
			$T_{vj} = 175 \text{ °C}$	3.7		
MOSFET forward recovery charge	$Q_{fr}$	$V_{DD} = 800 \text{ V},$ $I_{SD} = 13 \text{ A}, V_{GS} = 0 \text{ V},$ $-di_{SD}/dt = 2000 \text{ A}/\mu\text{s}, Q_{fr}$ includes also $Q_C$	$T_{vj} = 25 \text{ °C}$	106		nC
			$T_{vj} = 175 \text{ °C}$	207		
MOSFET peak forward recovery current	$I_{frm}$	$V_{DD} = 800 \text{ V},$ $I_{SD} = 13 \text{ A}, V_{GS} = 0 \text{ V},$ $-di_{SD}/dt = 2000 \text{ A}/\mu\text{s}, Q_{fr}$ includes also $Q_C$	$T_{vj} = 25 \text{ °C}$	7.8		A
			$T_{vj} = 175 \text{ °C}$	10.1		
Virtual junction temperature	$T_{vj}$		-55		175	°C

## 4 Characteristics diagrams

### Reverse bias safe operating area (RBSOA)

$$I_{DS} = f(V_{DS})$$

$$T_{vj} \leq 175\text{ °C}, V_{GS} = 0/20\text{ V}, T_c = 25\text{ °C}$$

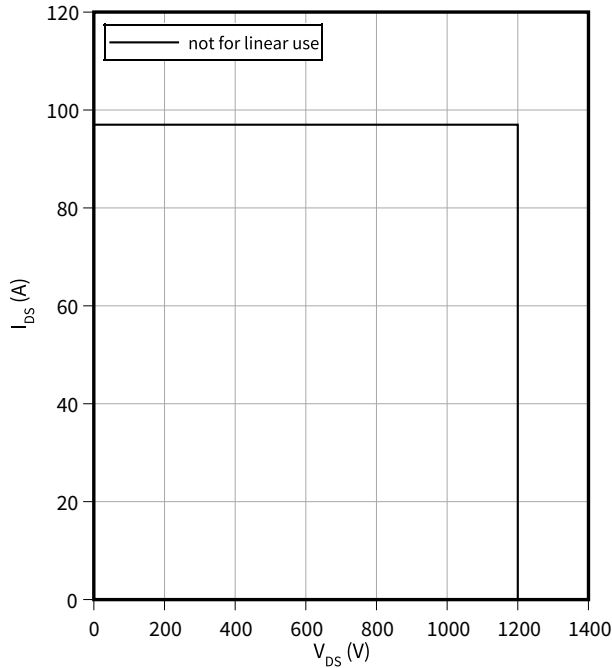

### Power dissipation as a function of case temperature

$$P_{tot} = f(T_c)$$

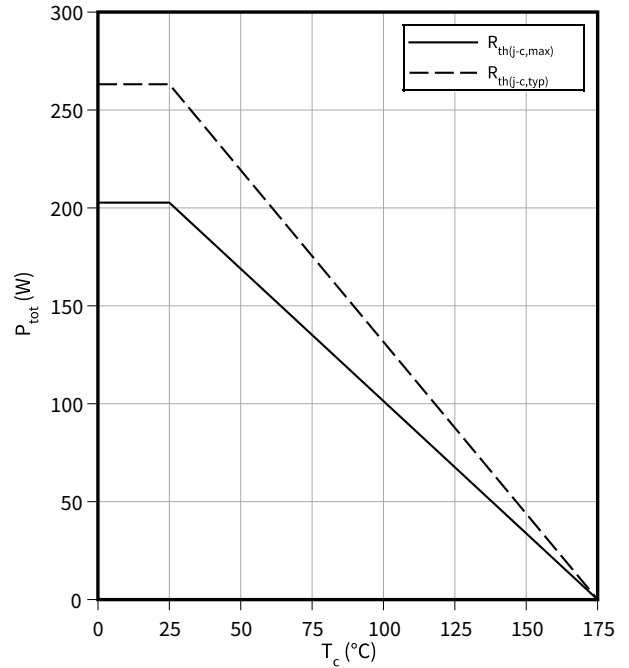

### Maximum DC drain to source current as a function of case temperature

$$I_{DS} = f(T_c)$$

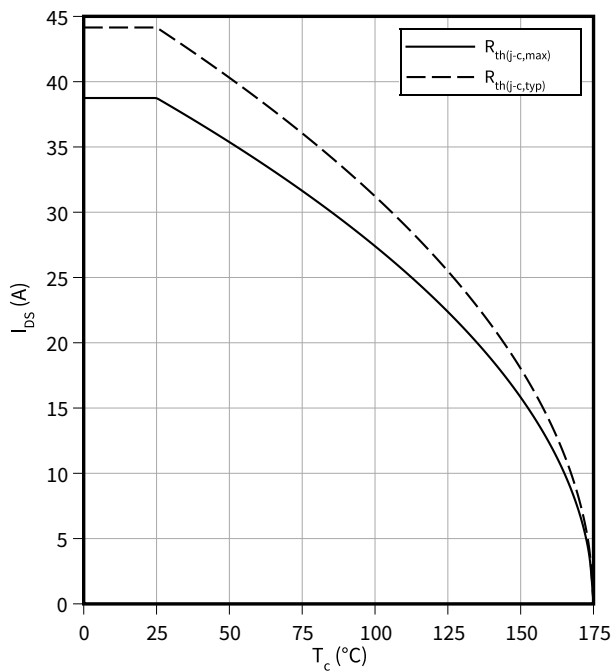

### Maximum source to drain current as a function of case temperature

$$I_{SD} = f(T_c)$$

$$V_{GS} = 0\text{ V}$$

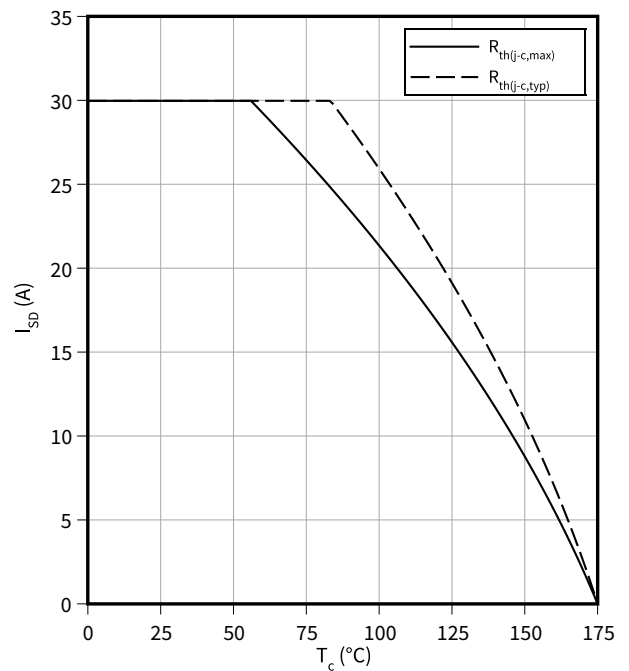

4 Characteristics diagrams

**Typical transfer characteristic**

$I_{DS} = f(V_{GS})$   
 $V_{DS} = 20 \text{ V}$ ,  $t_p = 20 \mu\text{s}$

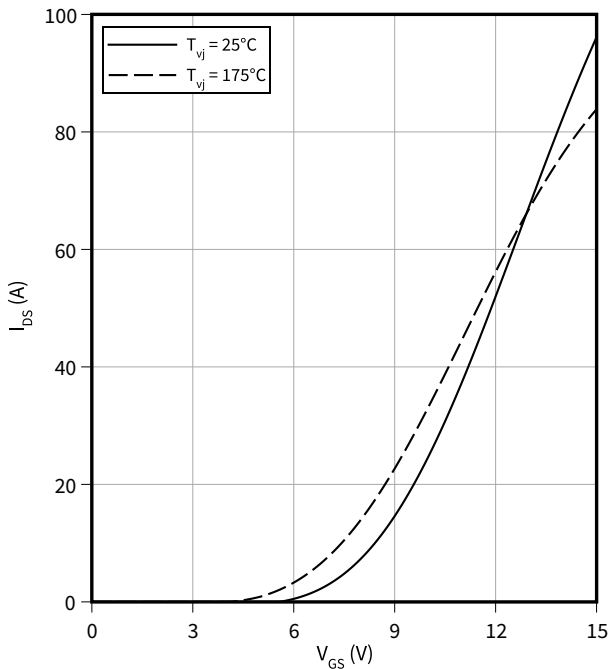

**Typical gate-source threshold voltage as a function of junction temperature**

$V_{GS(th)} = f(T_{vj})$   
 $I_D = 4.3 \text{ mA}$

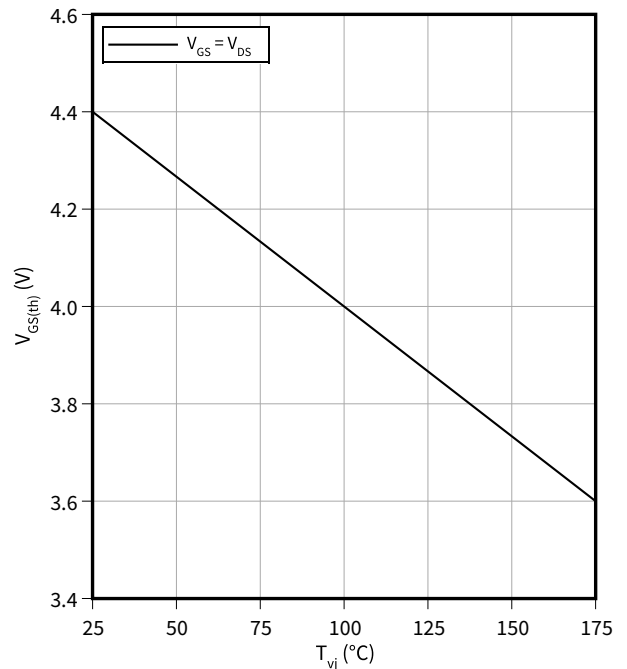

**Typical output characteristic,  $V_{GS}$  as parameter**

$I_{DS} = f(V_{DS})$   
 $T_{vj} = 25^\circ\text{C}$ ,  $t_p = 20 \mu\text{s}$

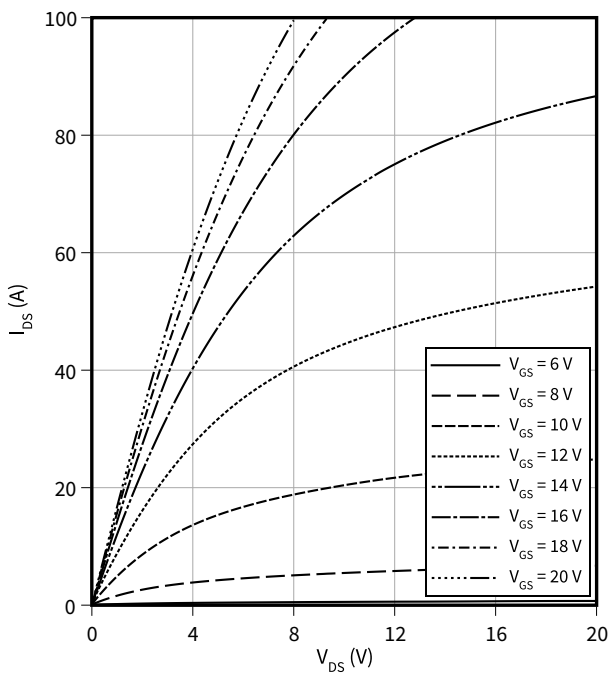

**Typical output characteristic,  $V_{GS}$  as parameter**

$I_{DS} = f(V_{DS})$   
 $T_{vj} = 175^\circ\text{C}$ ,  $t_p = 20 \mu\text{s}$

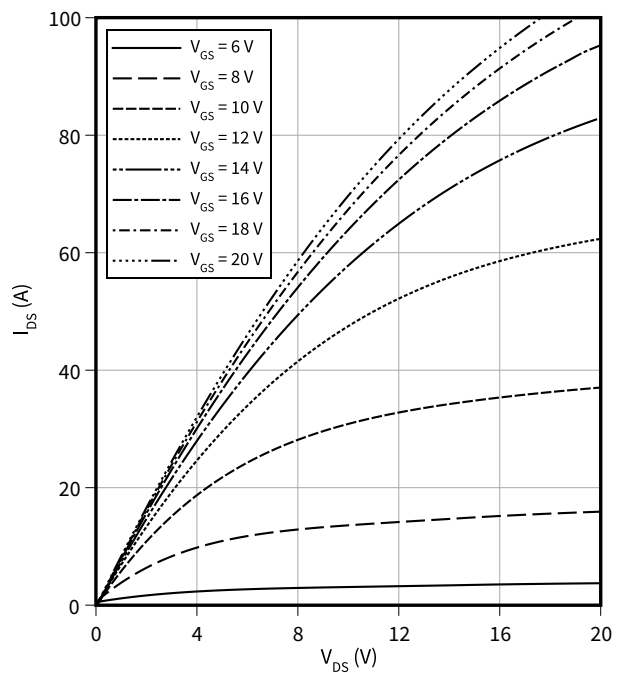



4 Characteristics diagrams

**Typical on-state resistance as a function of junction temperature**

$R_{DS(on)} = f(T_{vj})$   
 $I_D = 13 \text{ A}$

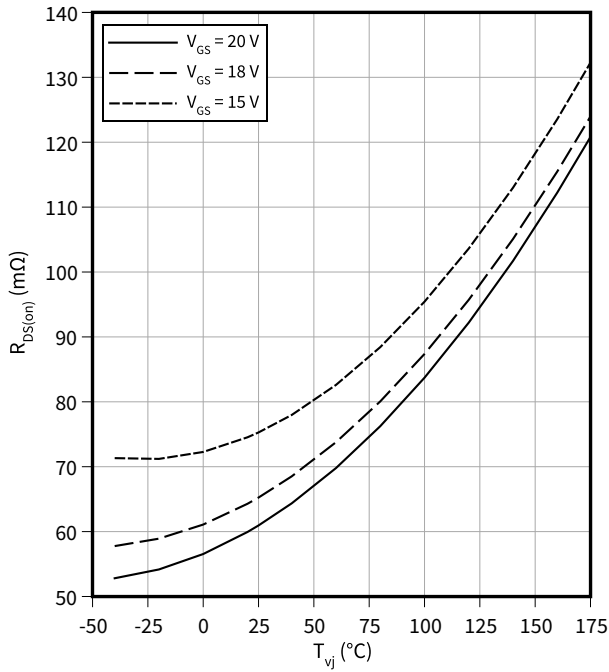

**Typical gate charge**

$V_{GS} = f(Q_G)$   
 $I_D = 13 \text{ A}, V_{DS} = 800 \text{ V}$

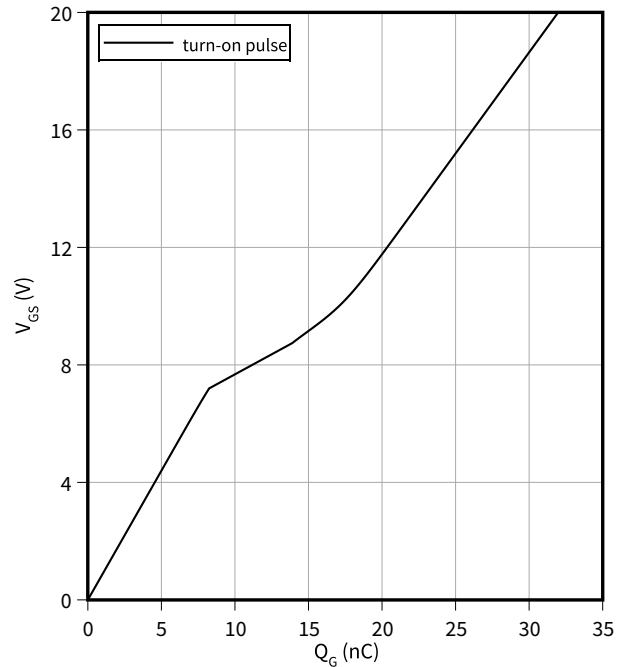

**Typical capacitance as a function of drain-source voltage**

$C = f(V_{DS})$   
 $f = 100 \text{ kHz}, V_{GS} = 0 \text{ V}$

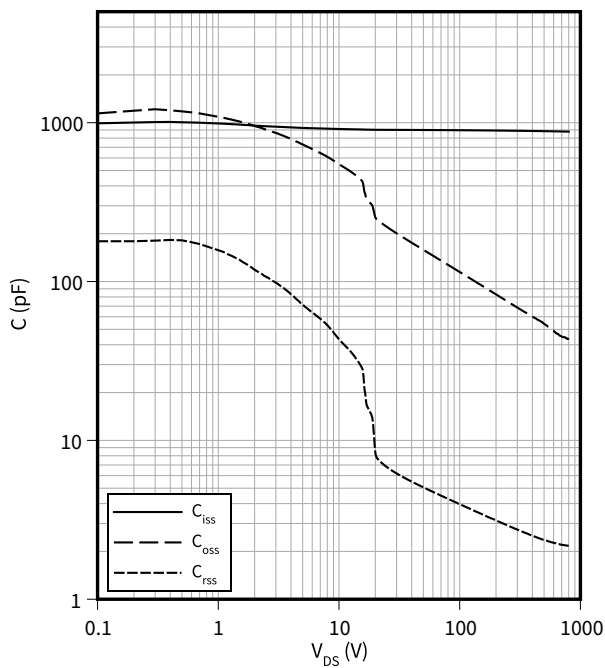

**Typical  $C_{OSS}$  stored energy**

$E_{OSS} = f(V_{DS})$   
 $f = 100 \text{ kHz}, V_{GS} = 0 \text{ V}$

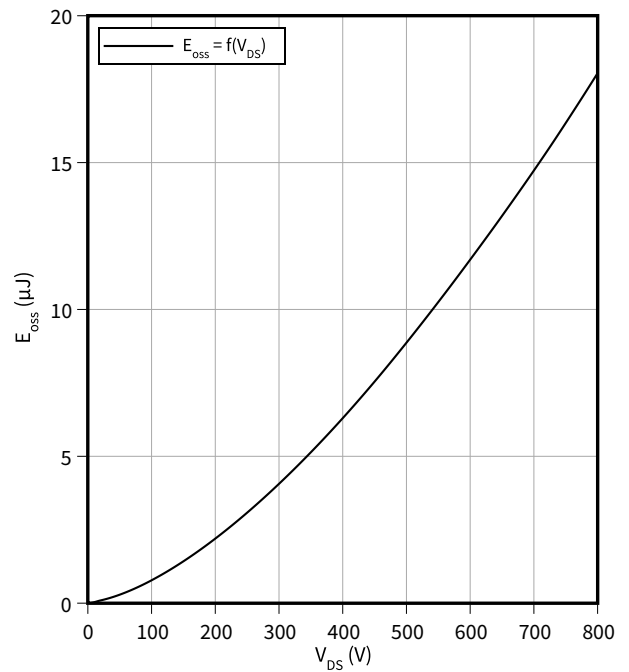

4 Characteristics diagrams

**Typical reverse drain voltage as function of junction temperature**

$V_{SD} = f(T_{vj})$   
 $I_{SD} = 13 \text{ A}, V_{GS} = 0 \text{ V}$

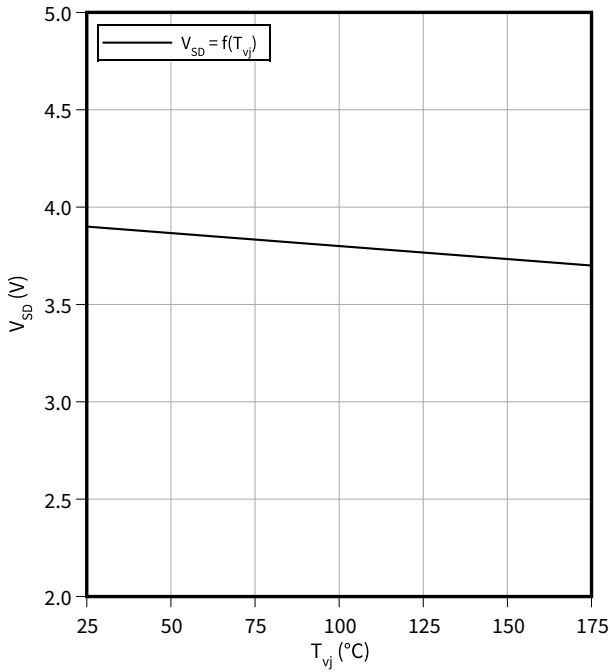

**Typical reverse drain current as function of reverse drain voltage,  $V_{GS}$  as parameter**

$I_{SD} = f(V_{SD})$   
 $T_{vj} = 25 \text{ °C}, t_p = 20 \mu\text{s}$

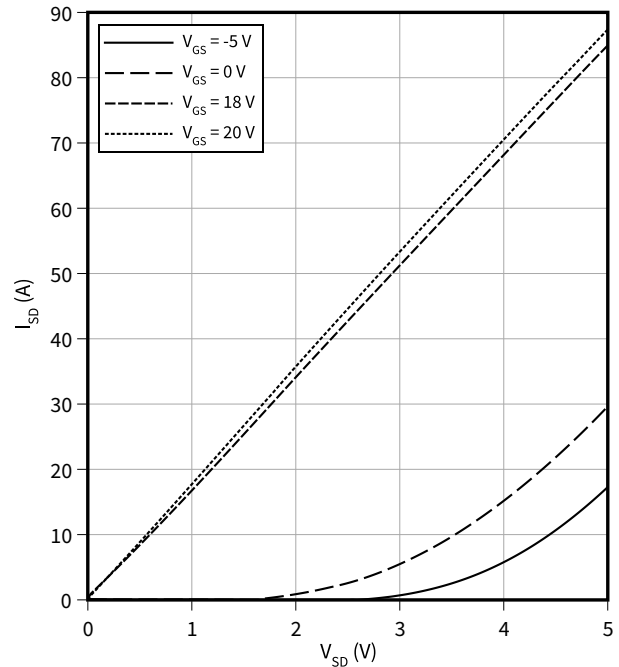

**Typical reverse drain current as function of reverse drain voltage,  $V_{GS}$  as parameter**

$I_{SD} = f(V_{SD})$   
 $T_{vj} = 175 \text{ °C}, t_p = 20 \mu\text{s}$

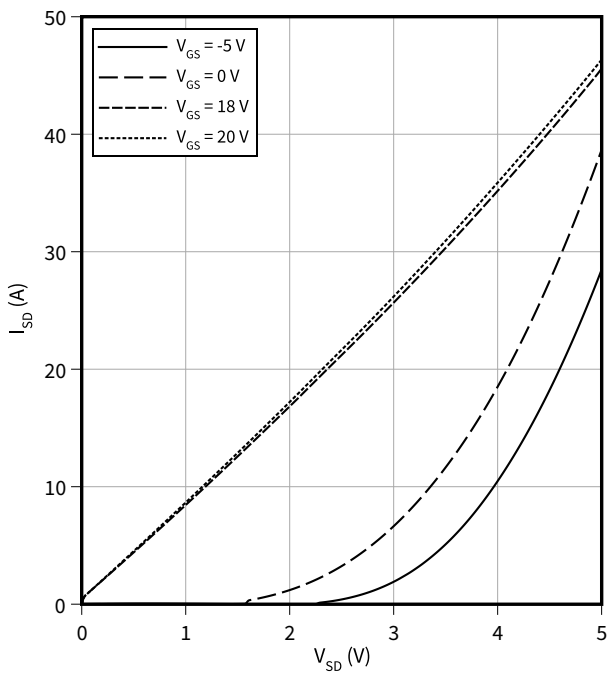

**Typical switching energy as a function of junction temperature, test circuit in Fig. F, 2nd device own body diode:  $V_{GS} = 0 \text{ V}$**

$E = f(T_{vj})$   
 $V_{GS} = 0/20 \text{ V}, I_D = 13 \text{ A}, R_{G,ext} = 2 \Omega, V_{DD} = 800 \text{ V}$

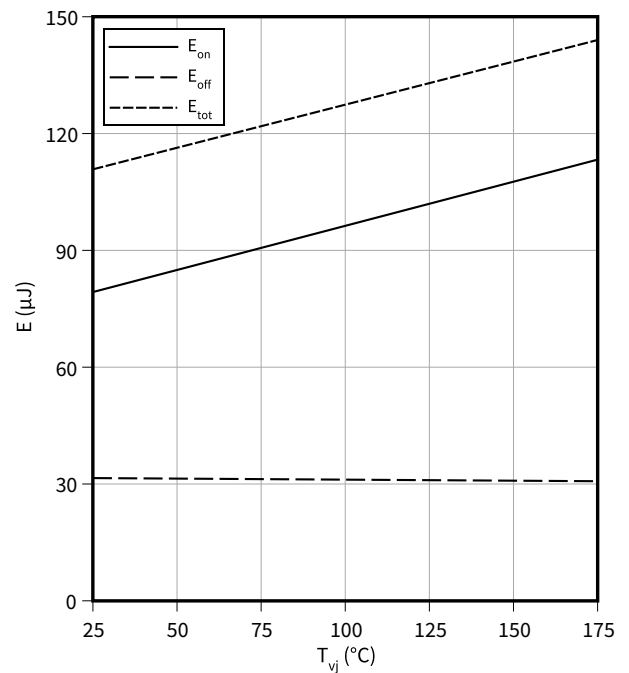

4 Characteristics diagrams

**Typical switching energy as a function of drain current, test circuit in Fig. F, 2nd device own body diode:  $V_{GS} = 0\text{ V}$**

$E = f(I_D)$

$V_{GS} = 0/20\text{ V}$ ,  $T_{vj} = 175\text{ °C}$ ,  $R_{G,ext} = 2\ \Omega$ ,  $V_{DD} = 800\text{ V}$

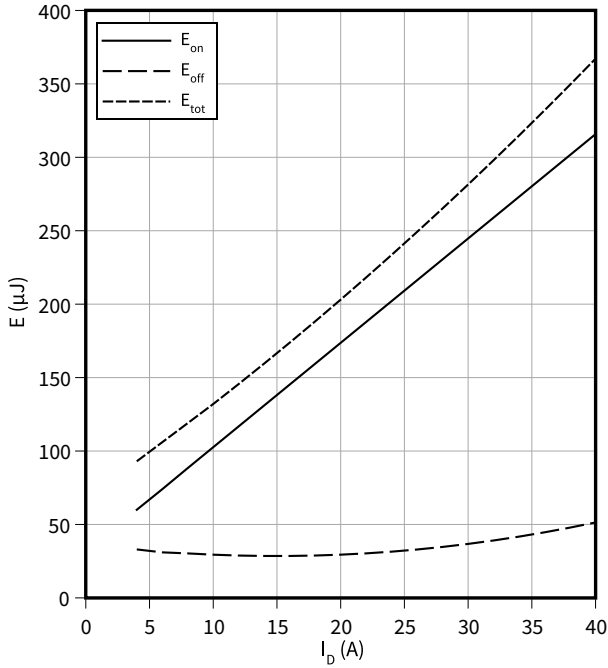

**Typical switching energy as a function of gate resistance, test circuit in Fig. F, 2nd device own body diode:  $V_{GS} = 0\text{ V}$**

$E = f(R_{G,ext})$

$V_{GS} = 0/20\text{ V}$ ,  $I_D = 13\text{ A}$ ,  $T_{vj} = 175\text{ °C}$ ,  $V_{DD} = 800\text{ V}$

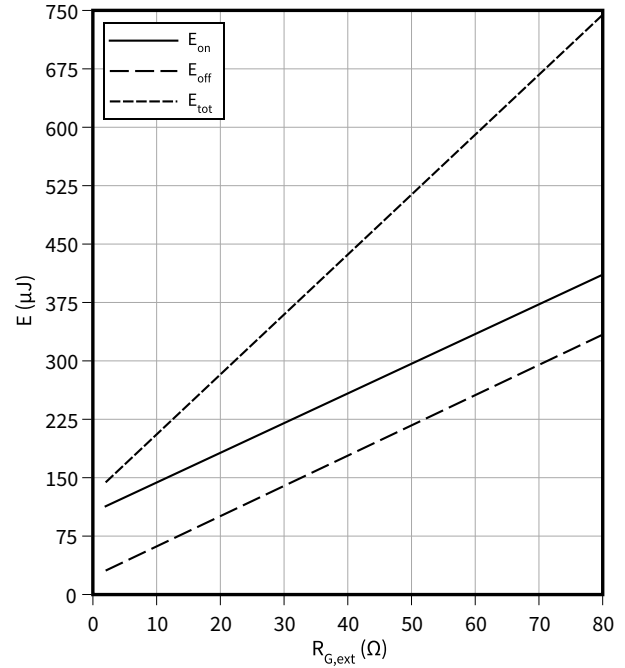

**Typical switching times as a function of gate resistance, test circuit in Fig. F, 2nd device own body diode:  $V_{GS} = 0\text{ V}$**

$t = f(R_{G,ext})$

$V_{GS} = 0/20\text{ V}$ ,  $I_D = 13\text{ A}$ ,  $T_{vj} = 175\text{ °C}$ ,  $V_{DD} = 800\text{ V}$

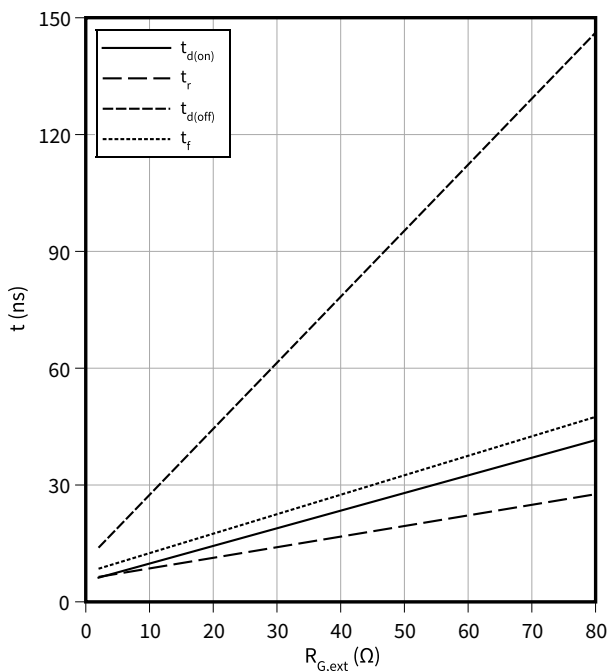

**Typical MOSFET peak forward recovery current as a function of reverse drain current slope**

$I_{frm} = f(-di_{SD}/dt)$

$V_{GS} = 0/20\text{ V}$ ,  $I_{SD} = 13\text{ A}$ ,  $V_{DD} = 800\text{ V}$

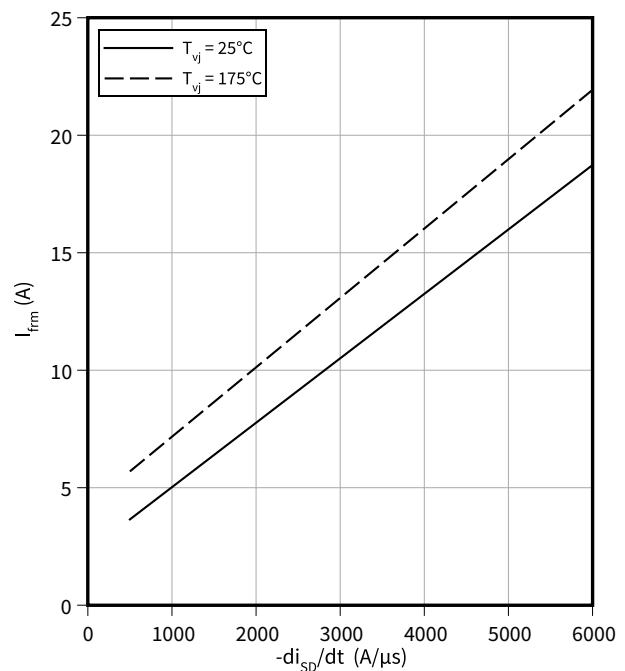

4 Characteristics diagrams

**Max. transient thermal impedance (MOSFET/diode)**

$$Z_{th(j-c),max} = f(t_p)$$

$$D = t_p/T$$

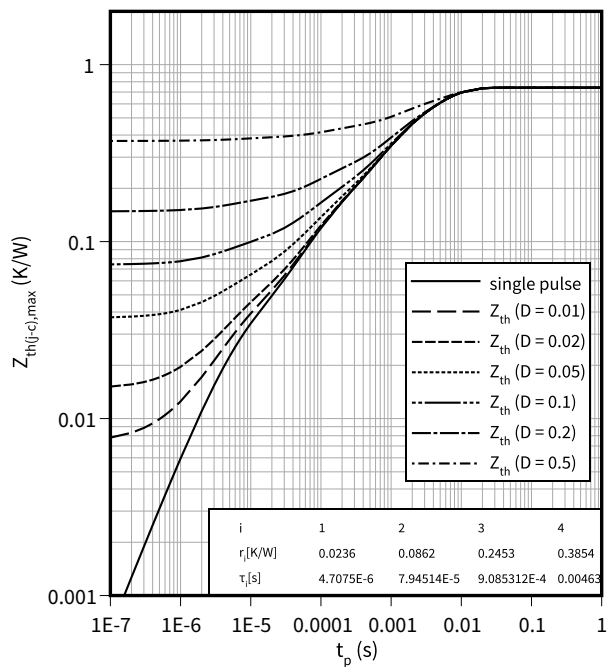

5 Package outlines

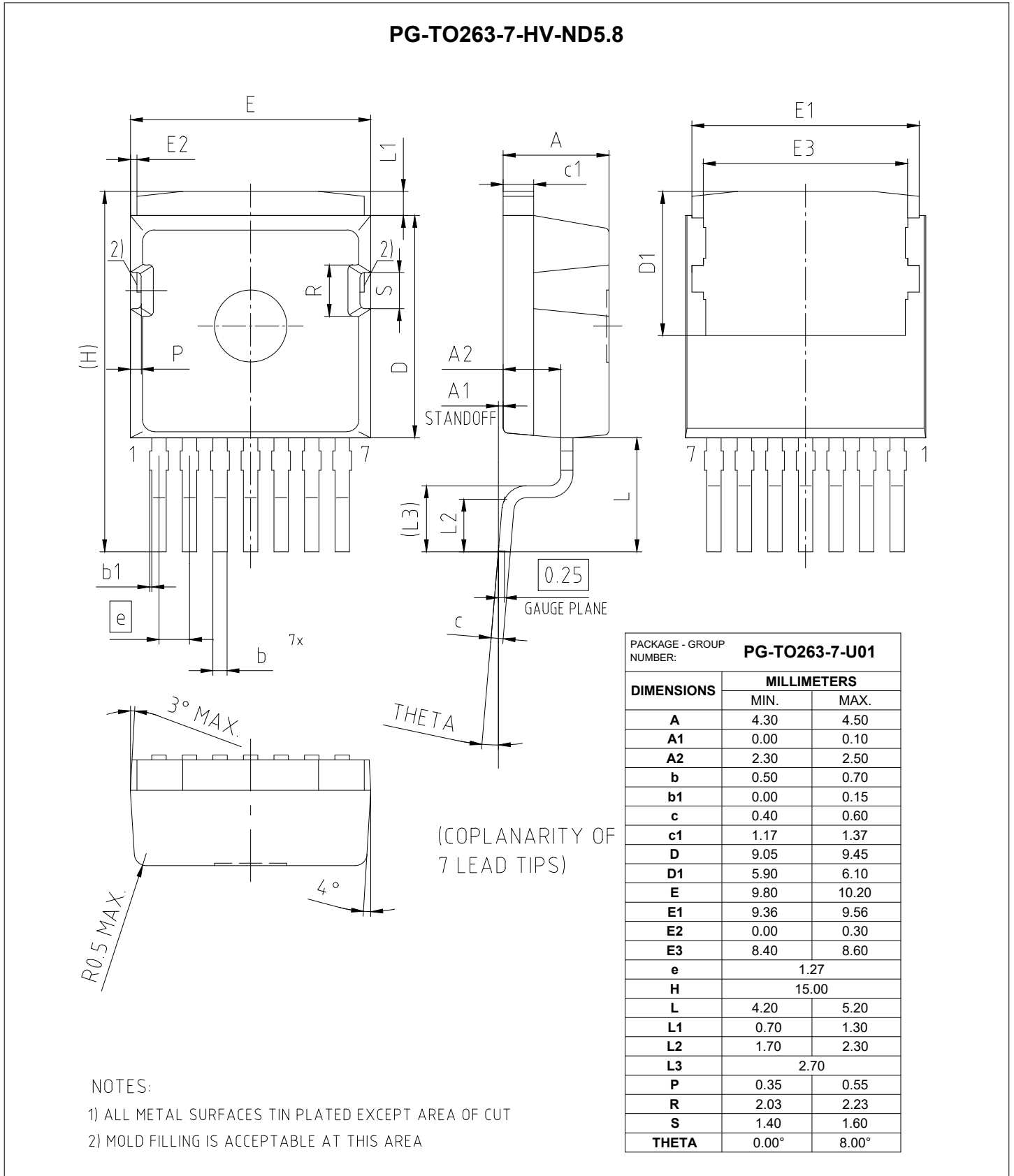

Figure 1

## 6 Testing conditions

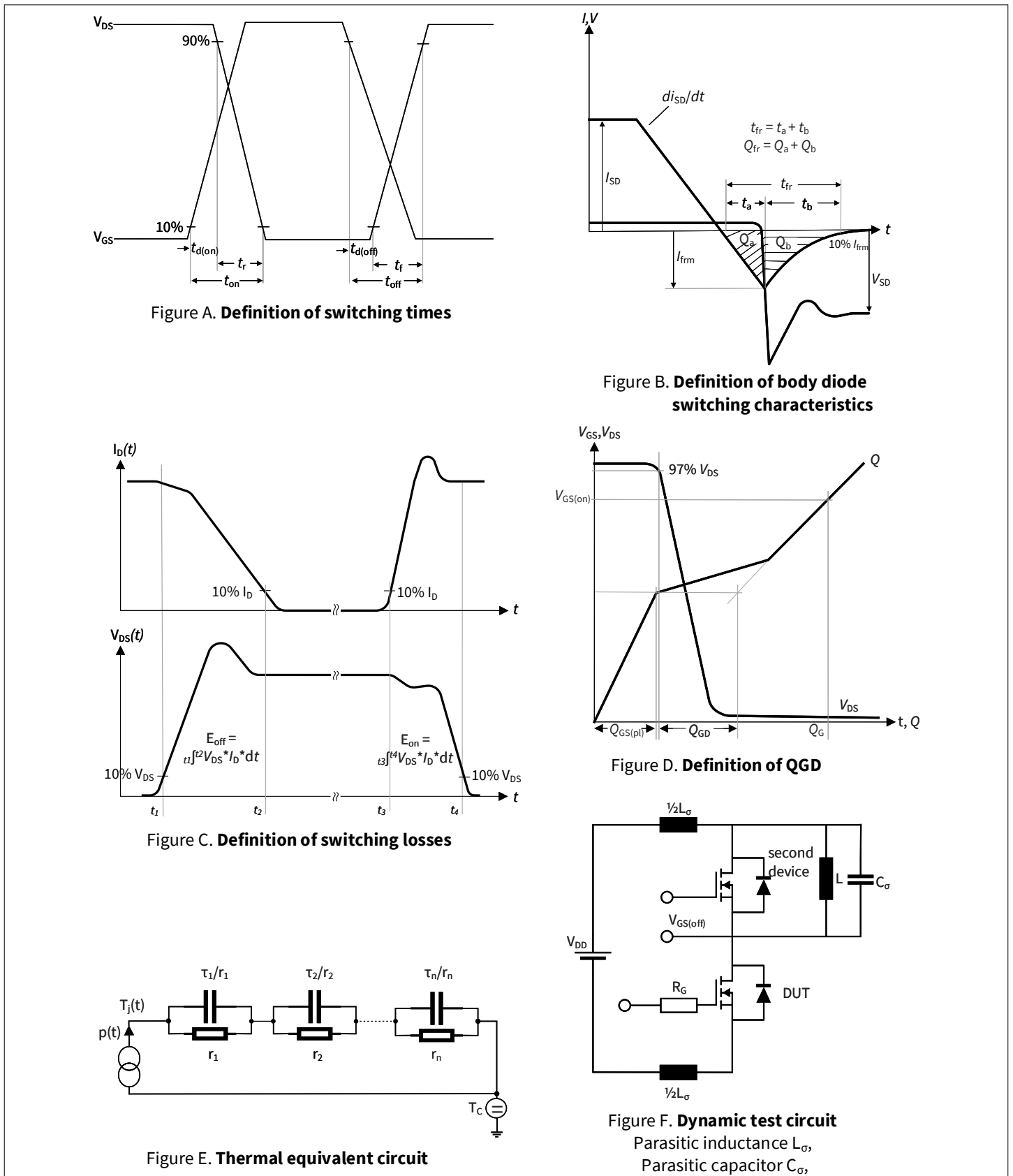

Figure 2

Revision history

**Revision history**

Document revision	Date of release	Description of changes
0.10	2022-12-08	Preliminary datasheet
0.20	2022-12-09	Update of "Drain-source on-state resistance", value ' <b>Max.</b> ' for 25°C, in Table 4 "Characteristic values"
1.00	2023-05-16	Final datasheet
1.10	2024-03-26	Updated table values: $V_{gsth}$ , $I_{dss}$ , $g_{fs}$ , $t_{don}$ , $t_r$ , $t_{doff}$ , $t_f$ , $E_{on}$ , $E_{off}$ , $E_{tot}$ , $Q_{fr}$ , $I_{frm}$ Updated graphs: $I_{DS} = f(V_{GS})$ , $V_{GS(th)} = f(T_{vj})$ , $I_{DS} = f(V_{DS})$ , $R_{DS(on)} = f(T_{vj})$ , $I_{SD} = f(V_{SD})$ , $E = f(T_{vj})$ , $E = f(R_{G,ext})$ , $t = f(R_{G,ext})$ , $I_{frm} = f(-diSD/dt)$ Added new graphs: $E = f(I_D)$ , $E_{oss} = f(V_{DS})$ No change to the product, new values based on additional characterization

## Trademarks

All referenced product or service names and trademarks are the property of their respective owners.

**Edition 2024-03-26**

**Published by**

**Infineon Technologies AG**

**81726 Munich, Germany**

**© 2024 Infineon Technologies AG**

**All Rights Reserved.**

**Do you have a question about any aspect of this document?**

**Email: [erratum@infineon.com](mailto:erratum@infineon.com)**

**Document reference**

**IFX-ABG168-004**

## Important notice

The information given in this document shall in no event be regarded as a guarantee of conditions or characteristics ("Beschaffheitsgarantie").

With respect to any examples, hints or any typical values stated herein and/or any information regarding the application of the product, Infineon Technologies hereby disclaims any and all warranties and liabilities of any kind, including without limitation warranties of non-infringement of intellectual property rights of any third party.

In addition, any information given in this document is subject to customer's compliance with its obligations stated in this document and any applicable legal requirements, norms and standards concerning customer's products and any use of the product of Infineon Technologies in customer's applications.

The data contained in this document is exclusively intended for technically trained staff. It is the responsibility of customer's technical departments to evaluate the suitability of the product for the intended application and the completeness of the product information given in this document with respect to such application.

## Warnings

Due to technical requirements products may contain dangerous substances. For information on the types in question please contact your nearest Infineon Technologies office.

Except as otherwise explicitly approved by Infineon Technologies in a written document signed by authorized representatives of Infineon Technologies, Infineon Technologies' products may not be used in any applications where a failure of the product or any consequences of the use thereof can reasonably be expected to result in personal injury.



## X-ON Electronics

Largest Supplier of Electrical and Electronic Components

*Click to view similar products for [Infineon manufacturer](#):*

Other Similar products are found below :

[0209085P001](#) [10TQ045](#) [111-4189PBF](#) [111-4190PBF](#) [16-1870-01](#) [16RIA80](#) [1EBN1001AEXUMA1](#) [1ED020I12-B2](#) [1ED020I12B2XUMA1](#)  
[1ED020I12-BT](#) [1ED020I12BTXUMA1](#) [1ED020I12-F](#) [1ED020I12-F2](#) [1ED020I12F2XUMA1](#) [1ED020I12FA2](#) [1ED020I12FA2XUMA2](#)  
[1ED020I12-FT](#) [1ED020I12FTA](#) [1ED020I12FTAXUMA2](#) [1ED3120MU12HXUMA1](#) [1ED3121MU12HXUMA1](#) [1ED3122MC12HXUMA1](#)  
[1ED3122MU12HXUMA1](#) [1ED3123MU12HXUMA1](#) [1ED3124MC12HXUMA1](#) [1ED3124MU12HXUMA1](#) [1ED3131MU12HXUMA1](#)  
[1ED3140MU12FXUMA1](#) [1ED3141MU12FXUMA1](#) [1ED3142MU12FXUMA1](#) [1ED3241MC12HXUMA1](#) [1ED3321MC12NXUMA1](#)  
[1ED3323MC12NXUMA1](#) [1ED3431MU12MXUMA1](#) [1ED3461MU12MXUMA1](#) [1ED3491MC12MXUMA1](#) [1ED3491MU12MXUMA1](#)  
[1ED3860MU12MXUMA1](#) [1ED3890MU12MXUMA1](#) [1ED44173N01BXTSA1](#) [1ED44175N01BXTSA1](#) [1ED44176N01FXUMA1](#)  
[1EDB7275F](#) [1EDB7275FXUMA1](#) [1EDB8275FXUMA1](#) [1EDB9275FXUMA1](#) [1EDC05I12AHXUMA1](#) [1EDC10I12MHXUMA1](#)  
[1EDC20H12AH](#) [1EDC20H12AHXUMA1](#)