

HEXFET® Power MOSFET

Features

- Advanced Planar Technology
- Low On-Resistance
- Logic Level Gate Drive
- Dynamic dv/dt Rating
- 150°C Operating Temperature
- Fast Switching
- Fully Avalanche Rated
- Repetitive Avalanche Allowed up to Tjmax
- Lead-Free, RoHS Compliant
- Automotive Qualified *

Description

Specifically designed for Automotive applications, this cellular design of HEXFET® Power MOSFETs utilizes the latest processing techniques to achieve low on-resistance per silicon area. This benefit combined with the fast switching speed and ruggedized device design that HEXFET power MOSFETs are well known for, provides the designer with an extremely efficient and reliable device for use in Automotive and a wide variety of other applications

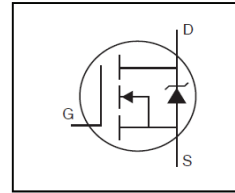

V_{DSS}	55V
$R_{DS(on)}$ max.	0.14Ω
I_D	2.0A

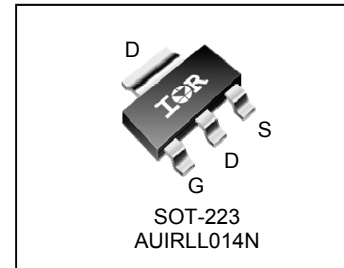

G	D	S
Gate	Drain	Source

Base part number	Package Type	Standard Pack		Orderable Part Number
		Form	Quantity	
AUIRLL014N	SOT-223	Tape and Reel	2500	AUIRLL014NTR

Absolute Maximum Ratings

Stresses beyond those listed under “Absolute Maximum Ratings” may cause permanent damage to the device. These are stress ratings only; and functional operation of the device at these or any other condition beyond those indicated in the specifications is not implied. Exposure to absolute-maximum-rated conditions for extended periods may affect device reliability. The thermal resistance and power dissipation ratings are measured under board mounted and still air conditions. Ambient temperature (TA) is 25°C, unless otherwise specified.

Symbol	Parameter	Max.	Units
$I_D @ T_A = 25^\circ\text{C}$	Continuous Drain Current, $V_{GS} @ 10\text{V} \textcircled{6}$	2.8	A
$I_D @ T_A = 25^\circ\text{C}$	Continuous Drain Current, $V_{GS} @ 10\text{V} \textcircled{5}$	2.0	
$I_D @ T_A = 70^\circ\text{C}$	Continuous Drain Current, $V_{GS} @ 10\text{V} \textcircled{5}$	1.6	
I_{DM}	Pulsed Drain Current $\textcircled{1}$	16	
$P_D @ T_A = 25^\circ\text{C}$	Maximum Power Dissipation (PCB Mount) $\textcircled{6}$	2.1	W
$P_D @ T_A = 25^\circ\text{C}$	Maximum Power Dissipation (PCB Mount) $\textcircled{5}$	1.0	
	Linear Derating Factor (PCB Mount) $\textcircled{5}$	8.3	mW/°C
V_{GS}	Gate-to-Source Voltage	± 16	V
E_{AS}	Single Pulse Avalanche Energy (Thermally Limited) $\textcircled{2}$	32	mJ
I_{AR}	Avalanche Current $\textcircled{1}$	2.0	A
E_{AR}	Repetitive Avalanche Energy $\textcircled{1} \textcircled{5}$	0.1	mJ
dv/dt	Peak Diode Recovery dv/dt $\textcircled{3}$	7.2	V/ns
T_J	Operating Junction and	-55 to + 150	°C
T_{STG}	Storage Temperature Range		

Thermal Resistance

Symbol	Parameter	Typ.	Max.	Units
$R_{\theta JA}$	Junction-to-Ambient (PCB Mount, steady state) $\textcircled{5}$	90	120	°C/W
$R_{\theta JA}$	Junction-to-Ambient (PCB Mount, steady state) $\textcircled{6}$	50	60	

HEXFET® is a registered trademark of Infineon.

*Qualification standards can be found at www.infineon.com

Static @ T_J = 25°C (unless otherwise specified)

	Parameter	Min.	Typ.	Max.	Units	Conditions
V _{(BR)DSS}	Drain-to-Source Breakdown Voltage	55	—	—	V	V _{GS} = 0V, I _D = 250μA
ΔV _{(BR)DSS} /ΔT _J	Breakdown Voltage Temp. Coefficient	—	0.015	—	V/°C	Reference to 25°C, I _D = 1mA
R _{DS(on)}	Static Drain-to-Source On-Resistance	—	—	0.14	Ω	V _{GS} = 10V, I _D = 2.0A ④
		—	—	0.20		V _{GS} = 5.0V, I _D = 1.2A ④
		—	—	0.28		V _{GS} = 4.0V, I _D = 1.0A ④
V _{GS(th)}	Gate Threshold Voltage	1.0	—	2.0	V	V _{DS} = V _{GS} , I _D = 250μA
g _{fs}	Forward Trans conductance	2.3	—	—	S	V _{DS} = 25V, I _D = 1.0A
I _{DSS}	Drain-to-Source Leakage Current	—	—	25	μA	V _{DS} = 55V, V _{GS} = 0V
		—	—	250		V _{DS} = 44V, V _{GS} = 0V, T _J = 150°C
I _{GSS}	Gate-to-Source Forward Leakage	—	—	100	nA	V _{GS} = 16V
	Gate-to-Source Reverse Leakage	—	—	-100		V _{GS} = -16V

Dynamic Electrical Characteristics @ T_J = 25°C (unless otherwise specified)

Q _g	Total Gate Charge	—	9.5	14	nC	I _D = 2.0A
Q _{gs}	Gate-to-Source Charge	—	1.1	1.7		V _{DS} = 44V
Q _{gd}	Gate-to-Drain Charge	—	3.0	4.4		V _{GS} = 10V, See Fig 6 and 9 ④
t _{d(on)}	Turn-On Delay Time	—	5.1	—	ns	V _{DD} = 28V
t _r	Rise Time	—	4.9	—		I _D = 2.0A
t _{d(off)}	Turn-Off Delay Time	—	14	—		R _G = 6.0Ω
t _f	Fall Time	—	2.9	—		R _D = 14Ω, See Fig. 10 ④
C _{iss}	Input Capacitance	—	230	—	pF	V _{GS} = 0V
C _{oss}	Output Capacitance	—	66	—		V _{DS} = 25V
C _{rss}	Reverse Transfer Capacitance	—	30	—		f = 1.0MHz, See Fig.5

Diode Characteristics

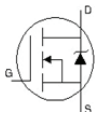
	Parameter	Min.	Typ.	Max.	Units	Conditions
I _S	Continuous Source Current (Body Diode)	—	—	1.3	A	MOSFET symbol showing the integral reverse p-n junction diode. 
I _{SM}	Pulsed Source Current (Body Diode) ①	—	—	16		
V _{SD}	Diode Forward Voltage	—	—	1.0	V	T _J = 25°C, I _S = 2.0A, V _{GS} = 0V ④
t _{rr}	Reverse Recovery Time	—	41	61	ns	T _J = 25°C, I _F = 2.0A,
Q _{rr}	Reverse Recovery Charge	—	73	110	nC	di/dt = 100A/μs ④
t _{on}	Forward Turn-On Time	Intrinsic turn-on time is negligible (turn-on is dominated by LS+LD)				

Notes:

- ① Repetitive rating; pulse width limited by max. junction temperature. (See fig. 11)
- ② V_{DD} = 25V, starting T_J = 25°C, L = 4.0mH, R_G = 25Ω, I_{AS} = 4.0A. (See fig. 12)
- ③ I_{SD} ≤ 2.0A, di/dt ≤ 170A/μs, V_{DD} ≤ V_{(BR)DSS}, T_J ≤ 150°C.
- ④ Pulse width ≤ 300μs; duty cycle ≤ 2%.
- ⑤ When mounted on FR-4 board using minimum recommended footprint.
- ⑥ When mounted on 1 inch square copper board, for comparison with other SMD devices.

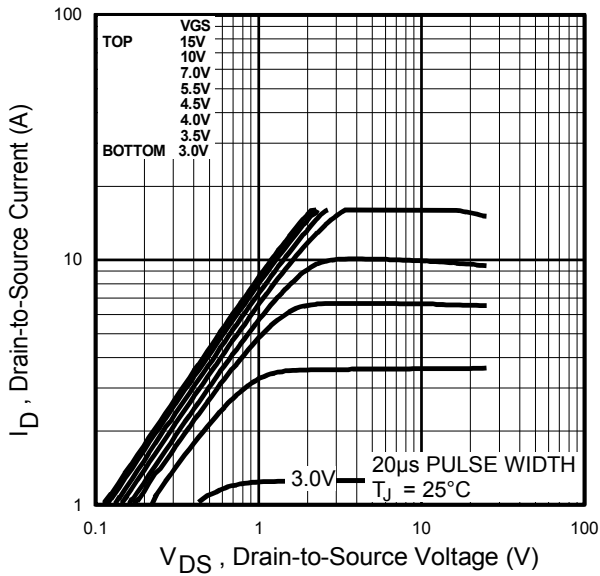
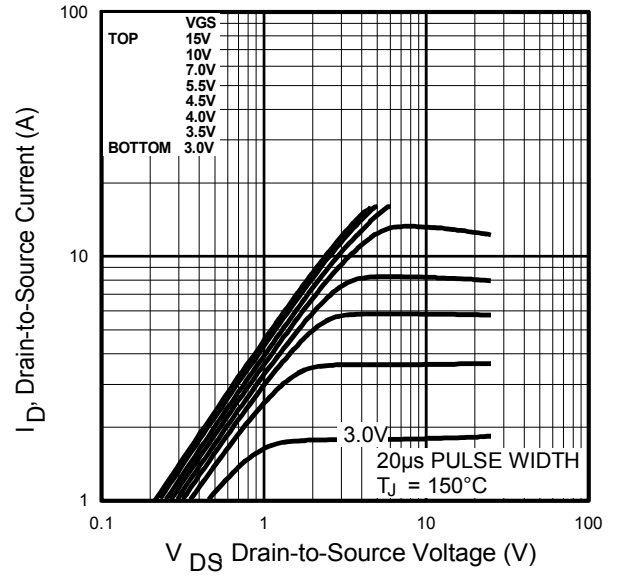
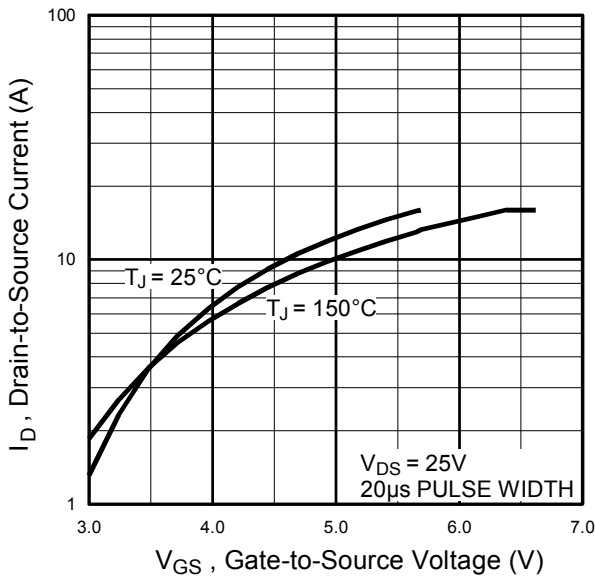
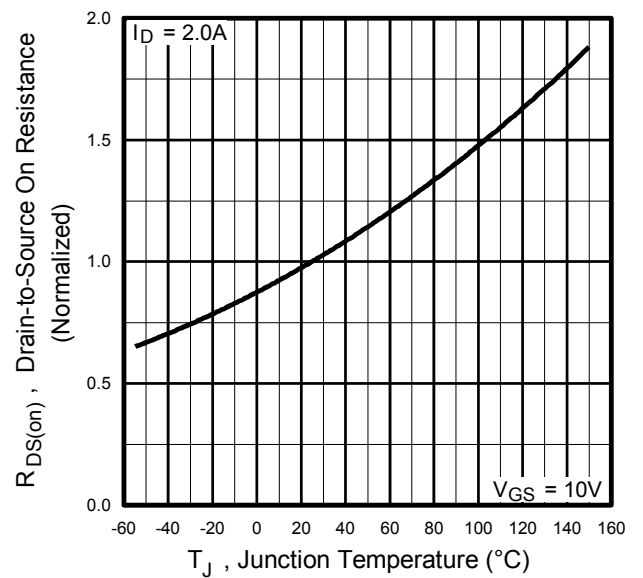
Fig. 1 Typical Output Characteristics

Fig. 2 Typical Output Characteristics

Fig. 3 Typical Transfer Characteristics

Fig. 4 Normalized On-Resistance vs. Temperature

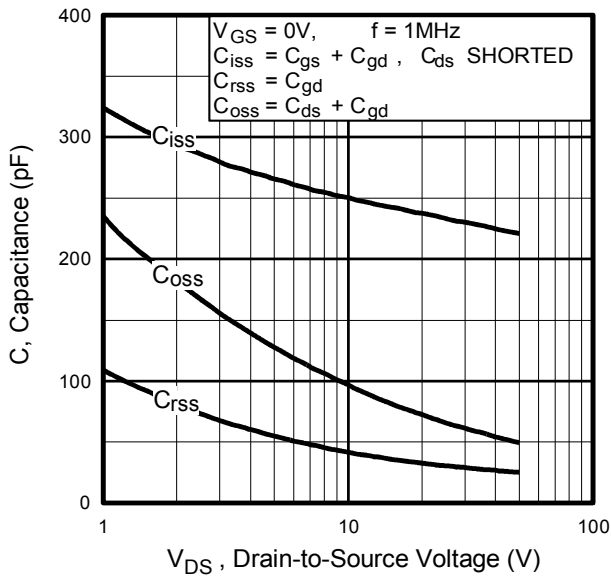

Fig 5. Typical Capacitance vs. Drain-to-Source Voltage

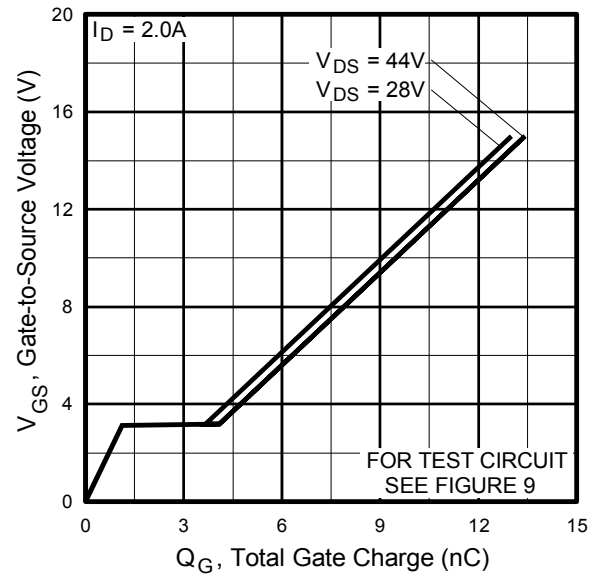

Fig 6. Typical Gate Charge vs. Gate-to-Source Voltage

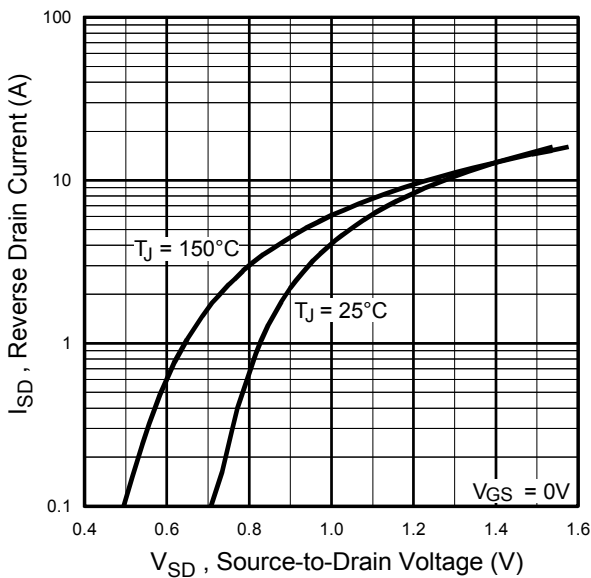

Fig 7 Typical Source-to-Drain Diode Forward Voltage

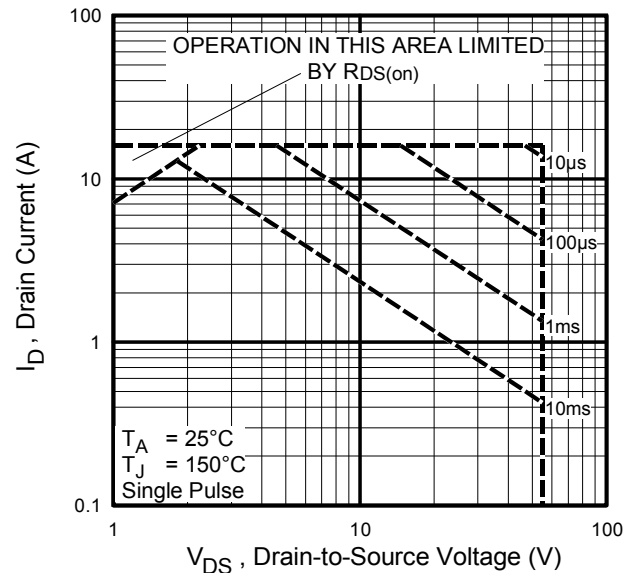
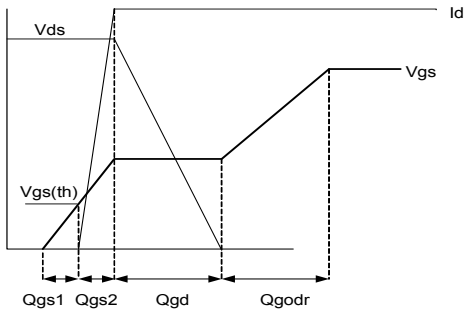
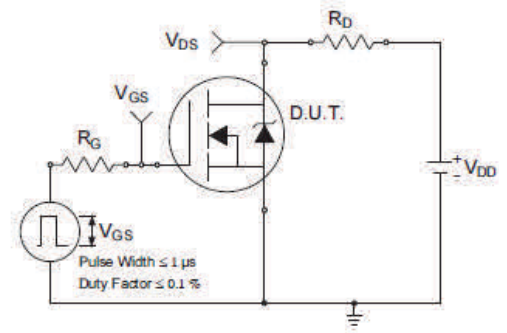
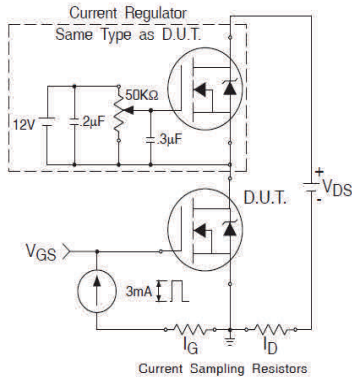
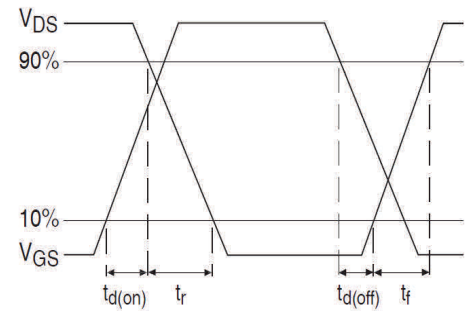
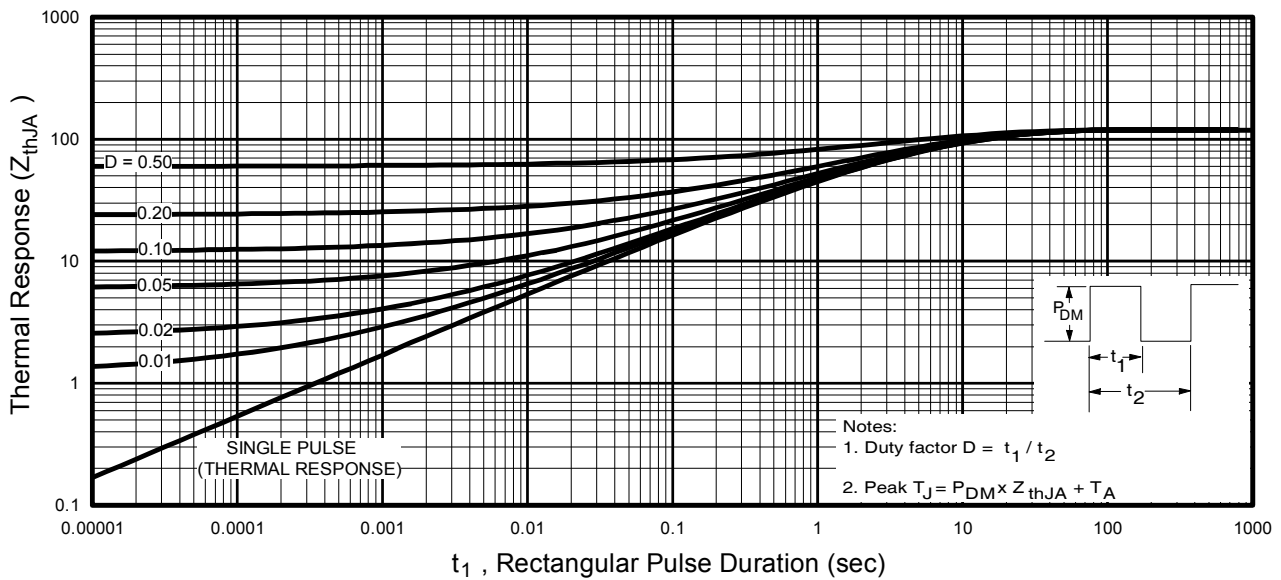
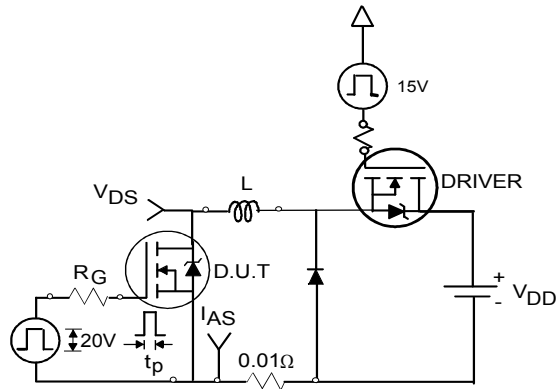
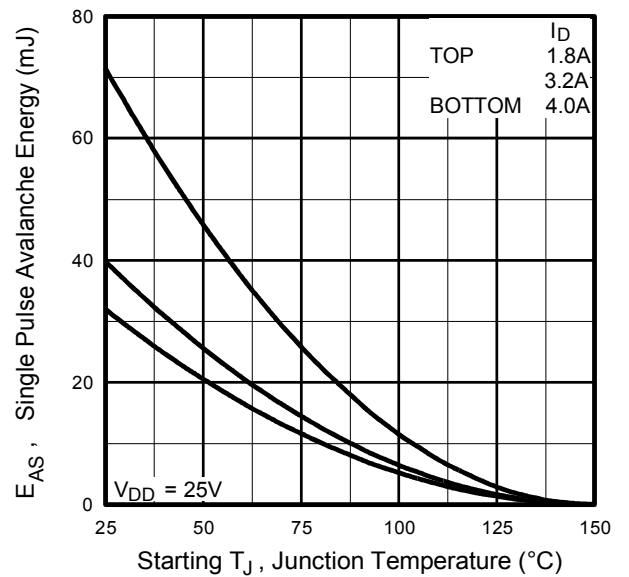
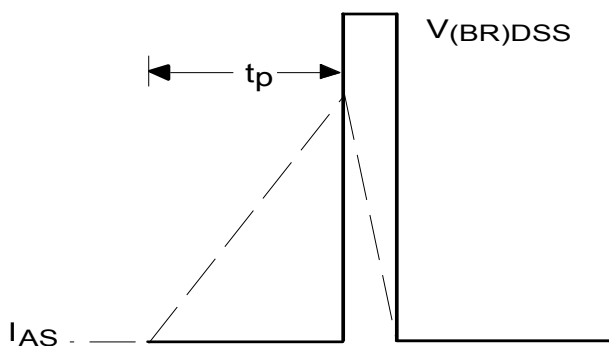
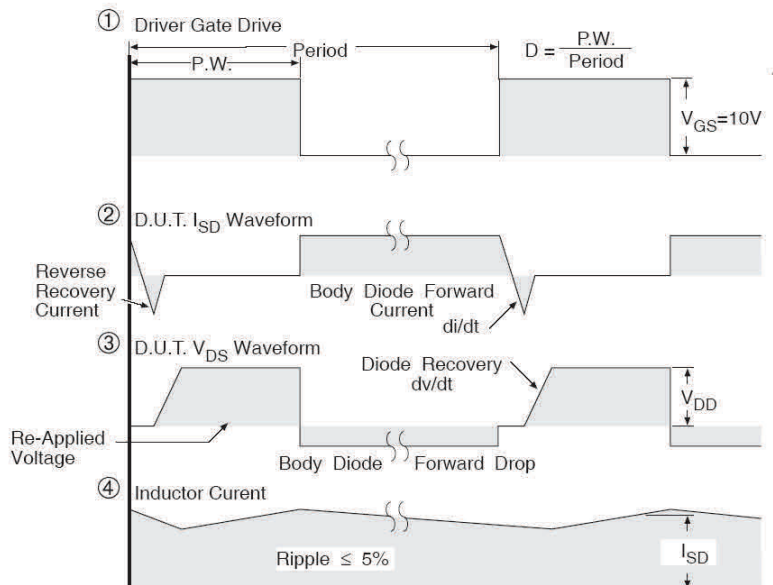
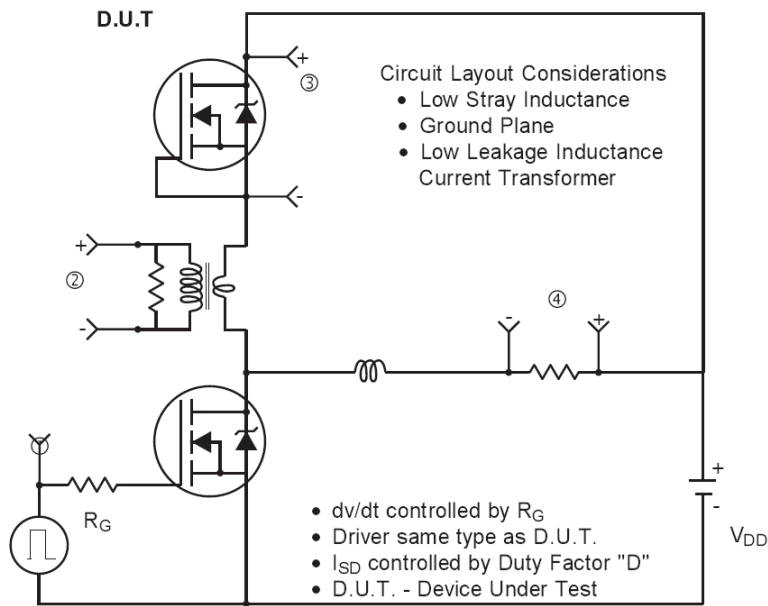

Fig 8. Maximum Safe Operating Area

Fig 9a. Basic Gate Charge Waveform

Fig 10a. Switching Time Test Circuit

Fig 9b. Gate Charge Test Circuit

Fig 10b. Switching Time Waveforms

Fig 11. Maximum Effective Transient Thermal Impedance, Junction-to-Ambient

Fig 12a. Unclamped Inductive Test Circuit

Fig 12c. Maximum Avalanche Energy Vs. Drain Current

Fig 12b. Unclamped Inductive Waveforms

Peak Diode Recovery dv/dt Test Circuit



* $V_{GS} = 5V$ for Logic Level Devices

Fig 13. Peak Diode Recovery dv/dt Test Circuit for N-Channel HEXFET® Power MOSFETs

SOT-223 (TO-261AA) Package Outline (Dimensions are shown in millimeters (inches))

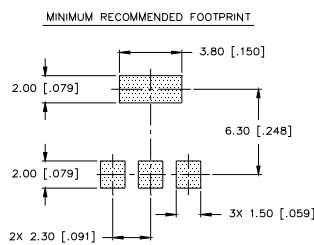
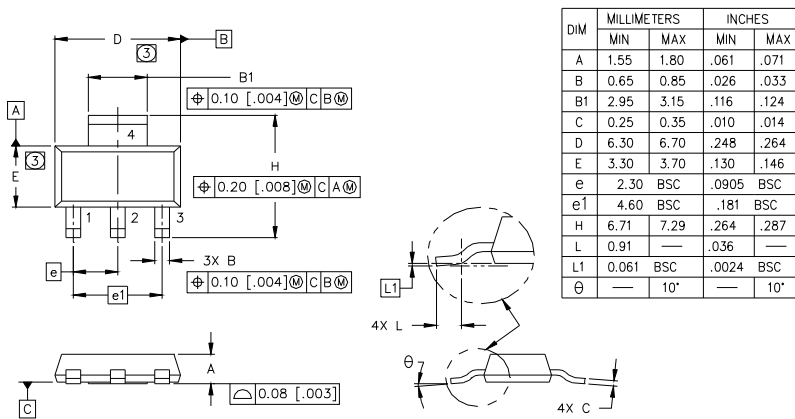

LEAD ASSIGNMENTS

1	=	GATE
2	=	DRAIN
3	=	SOURCE
4	=	DRAIN

- NOTES:**
1. DIMENSIONING & TOLERANCING PER ASME Y14.5M-1994.
 2. CONTROLLING DIMENSION: INCH.
 3. DIMENSIONS DO NOT INCLUDE MOLD FLASH.
 4. OUTLINE CONFORMS TO JEDEC OUTLINE TO-261AA.
 5. DIMENSIONS ARE SHOWN IN MILLIMETERS [INCHES].

SOT-223(TO-261AA) Part Marking Information

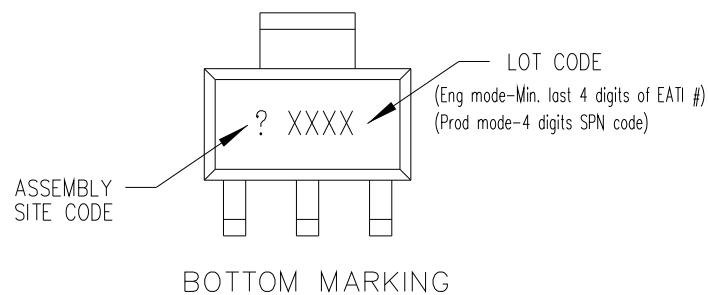
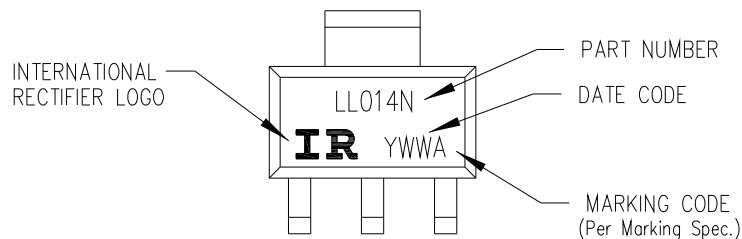

Note: For the most current drawing please refer to IR website at <http://www.irf.com/package/>

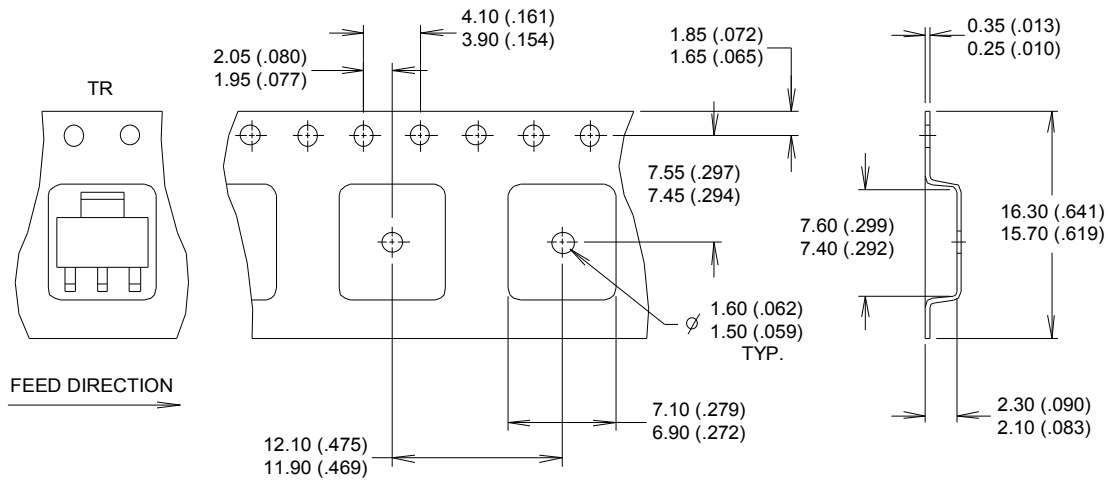
SOT-223(TO-261AA) Tape and Reel (Dimensions are shown in millimeters (inches))

NOTES :

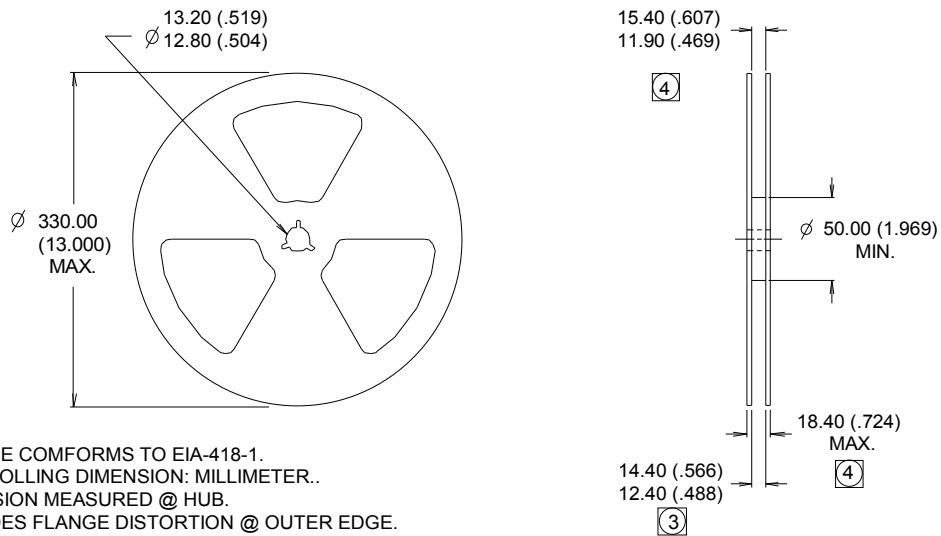
1. CONTROLLING DIMENSION: MILLIMETER.
2. OUTLINE CONFORMS TO EIA-481 & EIA-541.
3. EACH $\varnothing 330.00$ (13.00) REEL CONTAINS 2,500 DEVICES.

NOTES :

1. OUTLINE COMFORMS TO EIA-418-1.
2. CONTROLLING DIMENSION: MILLIMETER..
- ③ DIMENSION MEASURED @ HUB.
- ④ INCLUDES FLANGE DISTORTION @ OUTER EDGE.

Note: For the most current drawing please refer to IR website at <http://www.irf.com/package/>

Qualification Information

Qualification Level		Automotive (per AEC-Q101)	
		Comments: This part number(s) passed Automotive qualification. Infineon's Industrial and Consumer qualification level is granted by extension of the higher Automotive level.	
Moisture Sensitivity Level		SOT-223	MSL1
ESD	Machine Model	Class M1A (+/- 50V) [†] AEC-Q101-002	
	Human Body Model	Class H0 (+/- 250V) [†] AEC-Q101-001	
	Charged Device Model	Class C5 (+/- 1125V) [†] AEC-Q101-005	
RoHS Compliant		Yes	

† Highest passing voltage.

Revision History

Date	Comments
3/25/2014	<ul style="list-style-type: none"> Added "Logic Level Gate Drive" bullet in the features section on page 1 Updated part marking on page 8 Updated data sheet with new IR corporate template
10/29/2015	<ul style="list-style-type: none"> Updated datasheet with corporate template Corrected ordering table on page 1.

Published by

Infineon Technologies AG
81726 München, Germany

© Infineon Technologies AG 2015

All Rights Reserved.

IMPORTANT NOTICE

The information given in this document shall in no event be regarded as a guarantee of conditions or characteristics ("Beschaffenheitsgarantie"). With respect to any examples, hints or any typical values stated herein and/or any information regarding the application of the product, Infineon Technologies hereby disclaims any and all warranties and liabilities of any kind, including without limitation warranties of non-infringement of intellectual property rights of any third party.

In addition, any information given in this document is subject to customer's compliance with its obligations stated in this document and any applicable legal requirements, norms and standards concerning customer's products and any use of the product of Infineon Technologies in customer's applications.

The data contained in this document is exclusively intended for technically trained staff. It is the responsibility of customer's technical departments to evaluate the suitability of the product for the intended application and the completeness of the product information given in this document with respect to such application.

For further information on the product, technology, delivery terms and conditions and prices please contact your nearest Infineon Technologies office (www.infineon.com).

WARNINGS

Due to technical requirements products may contain dangerous substances. For information on the types in question please contact your nearest Infineon Technologies office.

Except as otherwise explicitly approved by Infineon Technologies in a written document signed by authorized representatives of Infineon Technologies, Infineon Technologies' products may not be used in any applications where a failure of the product or any consequences of the use thereof can reasonably be expected to result in personal injury.

X-ON Electronics

Largest Supplier of Electrical and Electronic Components

Click to view similar products for [MOSFET](#) category:

Click to view products by [Infineon](#) manufacturer:

Other Similar products are found below :

[614233C](#) [648584F](#) [IRFD120](#) [JANTX2N5237](#) [FCA20N60_F109](#) [FDZ595PZ](#) [2SK2545\(Q,T\)](#) [405094E](#) [423220D](#) [TPCC8103,L1Q\(CM](#)
[MIC4420CM-TR](#) [VN1206L](#) [614234A](#) [715780A](#) [NTNS3166NZT5G](#) [SSM6J414TU,LF\(T](#) [751625C](#) [BUK954R8-60E](#) [GROUP A 5962-](#)
[8877003PA](#) [NTE6400](#) [SQJ402EP-T1-GE3](#) [2SK2614\(TE16L1,Q\)](#) [2N7002KW-FAI](#) [DMN1017UCP3-7](#) [EFC2J004NUZTDG](#) [ECH8691-TL-W](#)
[FCAB21350L1](#) [P85W28HP2F-7071](#) [DMN1053UCP4-7](#) [NTE221](#) [NTE222](#) [NTE2384](#) [NTE2903](#) [NTE2941](#) [NTE2945](#) [NTE2946](#) [NTE2960](#)
[NTE2967](#) [NTE2969](#) [NTE2976](#) [NTE6400A](#) [NTE2910](#) [NTE2916](#) [NTE2956](#) [NTE2911](#) [DMN2080UCB4-7](#) [TK10A80W,S4X\(S](#)
[SSM6P69NU,LF](#) [DMP22D4UFO-7B](#) [DMN1006UCA6-7](#)