

Features

- Advanced Planar Technology
- Logic-Level Gate Drive
- Low On-Resistance
- 175°C Operating Temperature
- Fast Switching
- Fully Avalanche Rated
- Repetitive Avalanche Allowed up to Tjmax
- Lead-Free, RoHS Compliant
- Automotive Qualified *

HEXFET® Power MOSFET



V_{DSS}		55V
R_{DS(on)}	typ.	12mΩ
	max.	14mΩ
I_D (Silicon Limited)		61A
I_D (Package Limited)		30A

Description

Specifically designed for Automotive applications, this Stripe Planar design of HEXFET® Power MOSFETs utilizes the latest processing techniques to achieve low on-resistance per silicon area. This benefit combined with the fast switching speed and ruggedized device design that HEXFET power MOSFETs are well known for, provides the designer with an extremely efficient and reliable device for use in Automotive and a wide variety of other applications.

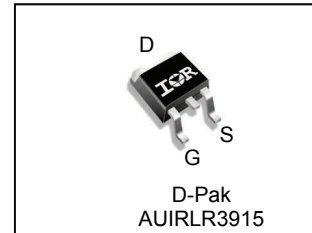

G	D	S
Gate	Drain	Source

Base part number	Package Type	Standard Pack		Orderable Part Number
		Form	Quantity	
AUIRLR3915	D-Pak	Tube	75	AUIRLR3915
		Tape and Reel Left	3000	AUIRLR3915TRL

Absolute Maximum Ratings

Stresses beyond those listed under “Absolute Maximum Ratings” may cause permanent damage to the device. These are stress ratings only; and functional operation of the device at these or any other condition beyond those indicated in the specifications is not implied. Exposure to absolute-maximum-rated conditions for extended periods may affect device reliability. The thermal resistance and power dissipation ratings are measured under board mounted and still air conditions. Ambient temperature (TA) is 25°C, unless otherwise specified.

Symbol	Parameter	Max.	Units
I _D @ T _C = 25°C	Continuous Drain Current, V _{GS} @ 10V (Silicon Limited)	61	A
I _D @ T _C = 100°C	Continuous Drain Current, V _{GS} @ 10V (Silicon Limited)	43	
I _D @ T _C = 25°C	Continuous Drain Current, V _{GS} @ 10V (Package Limited)	30	
I _{DM}	Pulsed Drain Current ①	240	
P _D @ T _C = 25°C	Maximum Power Dissipation	120	W
	Linear Derating Factor	0.77	W/°C
V _{GS}	Gate-to-Source Voltage	± 16	V
E _{AS}	Single Pulse Avalanche Energy (Thermally Limited) ②	200	mJ
E _{AS} (Tested)	Single Pulse Avalanche Energy Tested Value ③	600	
I _{AR}	Avalanche Current ①	See Fig.15,16, 12a, 12b	A
E _{AR}	Repetitive Avalanche Energy ④		mJ
T _J	Operating Junction and	-55 to + 175	°C
T _{STG}	Storage Temperature Range		
	Soldering Temperature, for 10 seconds (1.6mm from case)	300	

Thermal Resistance

Symbol	Parameter	Typ.	Max.	Units
R _{θJC}	Junction-to-Case ⑤	—	1.3	°C/W
R _{θJA}	Junction-to-Ambient (PCB Mount) ⑥	—	50	
R _{θJA}	Junction-to-Ambient	—	110	

HEXFET® is a registered trademark of Infineon.

*Qualification standards can be found at www.infineon.com

Static @ T_J = 25°C (unless otherwise specified)

	Parameter	Min.	Typ.	Max.	Units	Conditions
V _{(BR)DSS}	Drain-to-Source Breakdown Voltage	55	—	—	V	V _{GS} = 0V, I _D = 250μA
ΔV _{(BR)DSS} /ΔT _J	Breakdown Voltage Temp. Coefficient	—	0.057	—	V/°C	Reference to 25°C, I _D = 1mA
R _{DS(on)}	Static Drain-to-Source On-Resistance	—	12	14	mΩ	V _{GS} = 10V, I _D = 30A ④
		—	14	17		V _{GS} = 5.0V, I _D = 26A ④
V _{GS(th)}	Gate Threshold Voltage	1.0	—	3.0	V	V _{DS} = V _{GS} , I _D = 250μA
g _{fs}	Forward Trans conductance	42	—	—	S	V _{DS} = 25V, I _D = 30A ④
I _{DSS}	Drain-to-Source Leakage Current	—	—	20	μA	V _{DS} = 55V, V _{GS} = 0V
		—	—	250		V _{DS} = 55V, V _{GS} = 0V, T _J = 125°C
I _{GSS}	Gate-to-Source Forward Leakage	—	—	200	nA	V _{GS} = 16V
	Gate-to-Source Reverse Leakage	—	—	-200		V _{GS} = -16V

Dynamic Electrical Characteristics @ T_J = 25°C (unless otherwise specified)

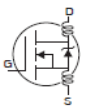
Q _g	Total Gate Charge	—	61	92	nC	I _D = 30A
Q _{gs}	Gate-to-Source Charge	—	9.0	14		V _{DS} = 44V
Q _{gd}	Gate-to-Drain Charge	—	17	25		V _{GS} = 10V ④
t _{d(on)}	Turn-On Delay Time	—	7.4	—	ns	V _{DD} = 28V
t _r	Rise Time	—	51	—		I _D = 30A
t _{d(off)}	Turn-Off Delay Time	—	83	—		R _G = 8.5Ω
t _f	Fall Time	—	100	—		V _{GS} = 10V ④
L _D	Internal Drain Inductance	—	4.5	—	nH	Between lead, 6mm (0.25in.) from package and center of die contact
L _S	Internal Source Inductance	—	7.5	—		
C _{iss}	Input Capacitance	—	1870	—	pF	V _{GS} = 0V
C _{oss}	Output Capacitance	—	390	—		V _{DS} = 25V
C _{rss}	Reverse Transfer Capacitance	—	74	—		f = 1.0MHz, See Fig. 5
C _{oss}	Output Capacitance	—	2380	—		V _{GS} = 0V, V _{DS} = 1.0V f = 1.0MHz
C _{oss}	Output Capacitance	—	290	—		V _{GS} = 0V, V _{DS} = 44V f = 1.0MHz
C _{oss eff.}	Effective Output Capacitance ⑤	—	540	—		V _{GS} = 0V, V _{DS} = 0V to 44V

Diode Characteristics

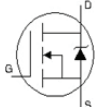
	Parameter	Min.	Typ.	Max.	Units	Conditions
I _S	Continuous Source Current (Body Diode)	—	—	61	A	MOSFET symbol showing the integral reverse p-n junction diode. 
I _{SM}	Pulsed Source Current (Body Diode) ①	—	—	240		
V _{SD}	Diode Forward Voltage	—	—	1.3	V	T _J = 25°C, I _S = 30A, V _{GS} = 0V ④
t _{rr}	Reverse Recovery Time	—	62	93	ns	T _J = 25°C, I _F = 30A, V _{DD} = 25V
Q _{rr}	Reverse Recovery Charge	—	110	170	nC	di/dt = 100A/μs ④
t _{on}	Forward Turn-On Time	Intrinsic turn-on time is negligible (turn-on is dominated by L _S +L _D)				

Notes:

- ① Repetitive rating; pulse width limited by max. junction temperature. (See fig. 11)
- ② Limited by T_{Jmax}, starting T_J = 25°C, L = 0.45mH, R_G = 25Ω, I_{AS} = 30A, V_{GS} = 10V. Part not recommended for use above this value.
- ③ I_{SD} ≤ 30A, di/dt ≤ 280A/μs, V_{DD} ≤ V_{(BR)DSS}, T_J ≤ 175°C.
- ④ Pulse width ≤ 1.0ms; duty cycle ≤ 2%.
- ⑤ C_{oss eff.} is a fixed capacitance that gives the same charging time as C_{oss} while V_{DS} is rising from 0 to 80% V_{DSS}
- ⑥ Limited by T_{Jmax}, see Fig.12a, 12b, 15, 16 for typical repetitive avalanche performance.
- ⑦ This value determined from sample failure population, starting T_J = 25°C, L = 0.45mH, R_G = 25Ω, I_{AS} = 30A, V_{GS} = 10V.
- ⑧ When mounted on 1" square PCB (FR-4 or G-10 Material). For recommended footprint and soldering techniques refer to application note #AN-994
- ⑨ R_θ is measured at T_J approximately 90°C.

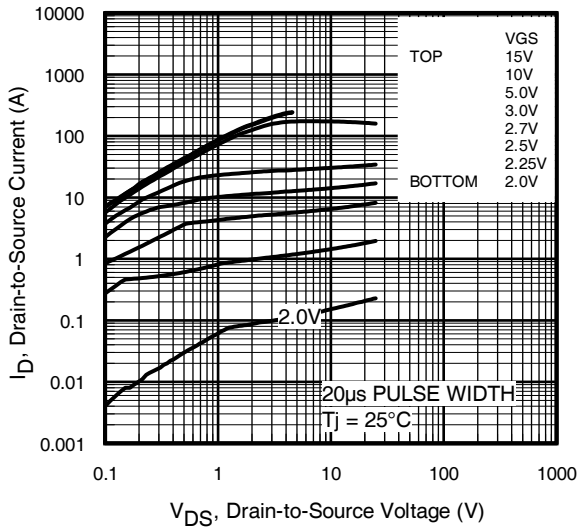
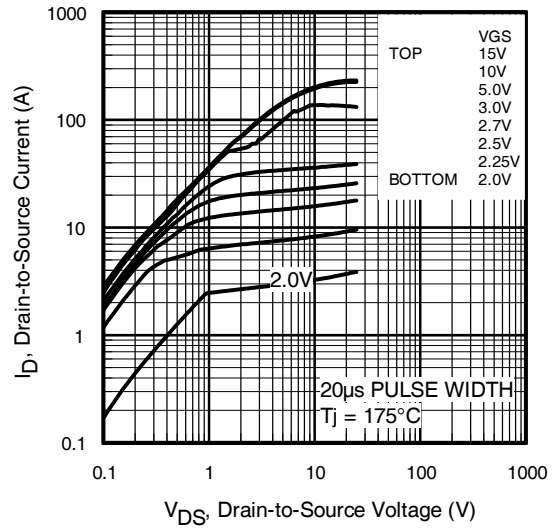
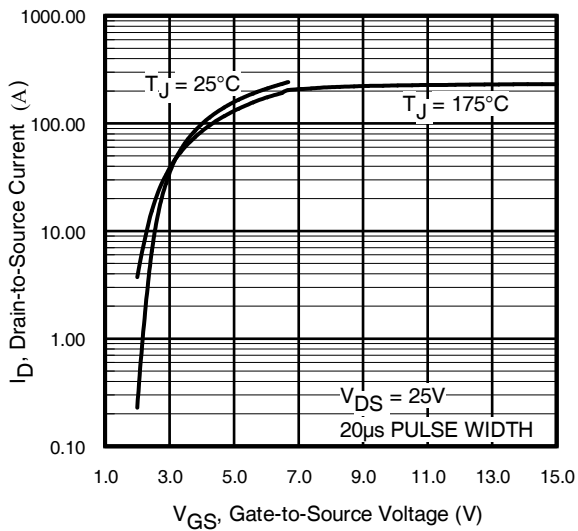
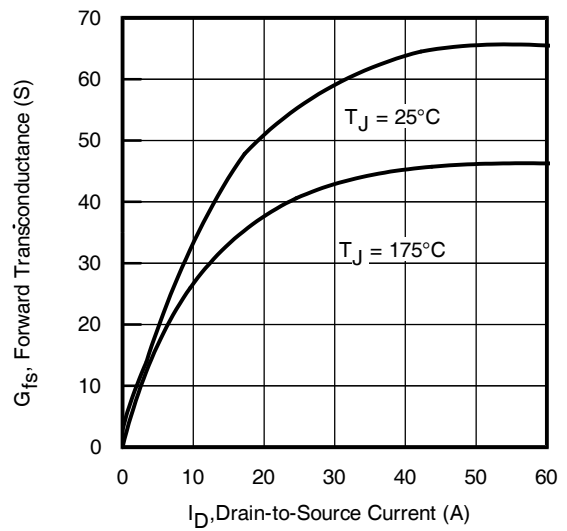
Fig. 1 Typical Output Characteristics

Fig. 2 Typical Output Characteristics

Fig. 3 Typical Transfer Characteristics

Fig. 4 Typical Forward Trans conductance Vs. Drain Current

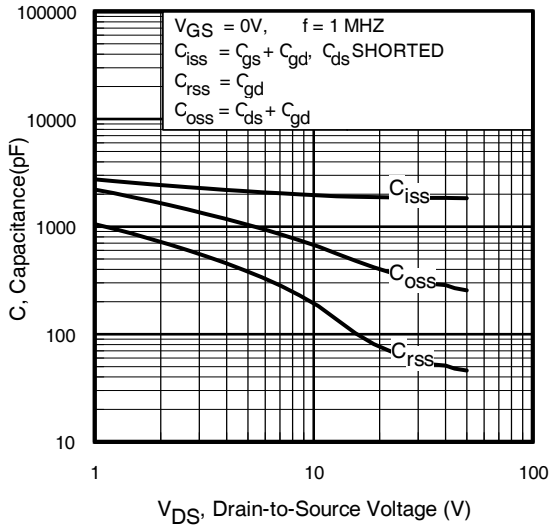

Fig 5. Typical Capacitance vs. Drain-to-Source Voltage

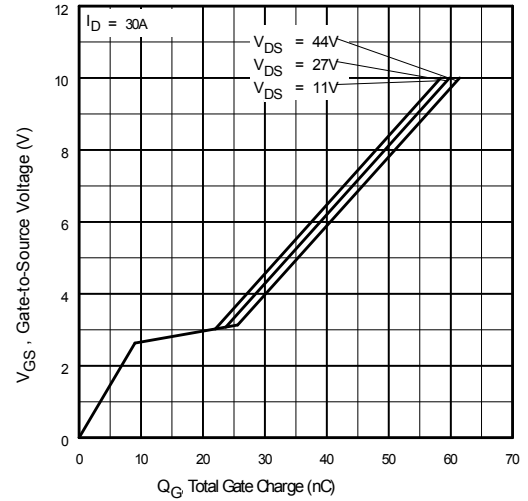

Fig 6. Typical Gate Charge vs. Gate-to-Source Voltage

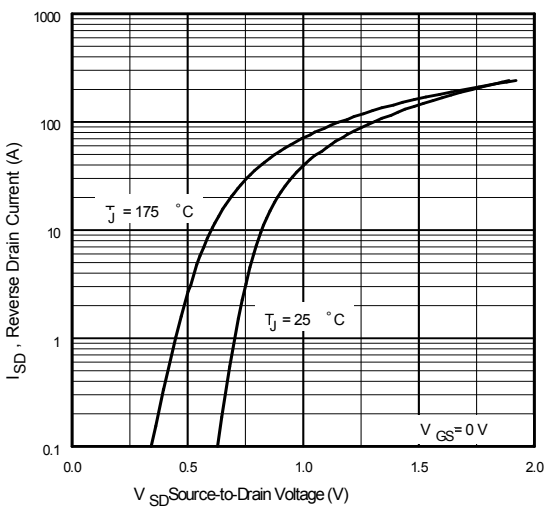

Fig 7. Typical Source-to-Drain Diode Forward Voltage

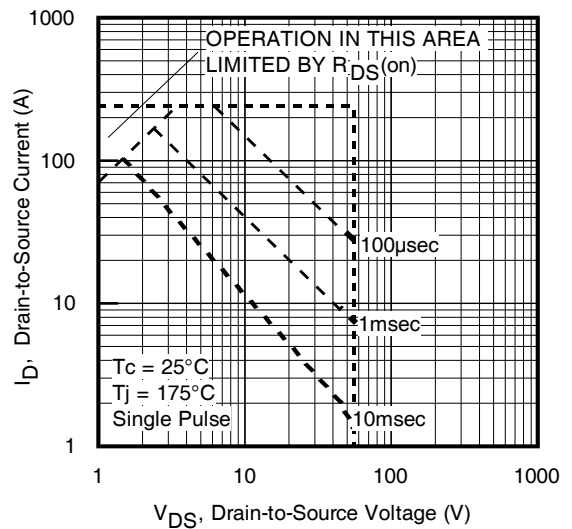

Fig 8. Maximum Safe Operating Area

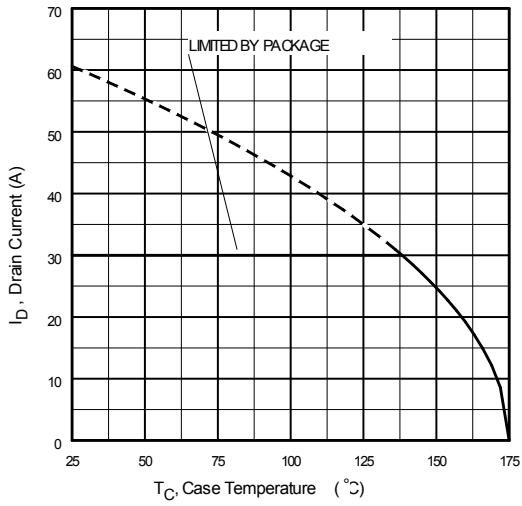

Fig 9. Maximum Drain Current Vs. Case Temperature

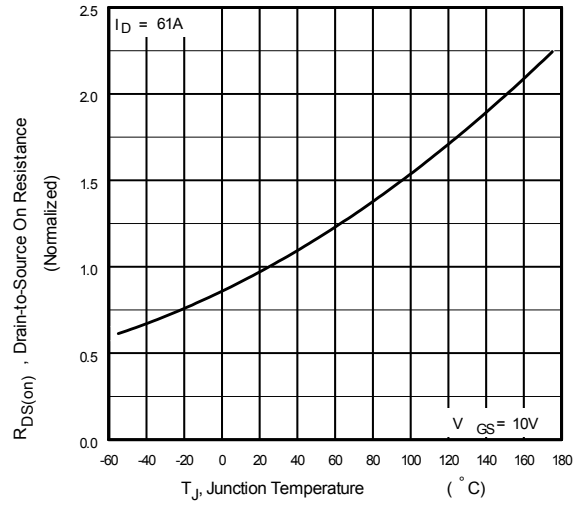

Fig 10. Normalized On-Resistance Vs. Temperature

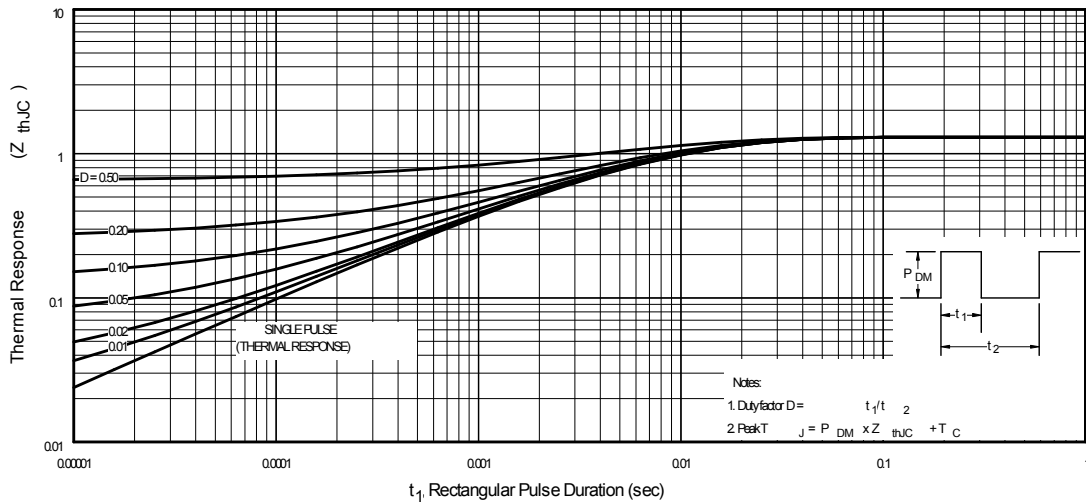
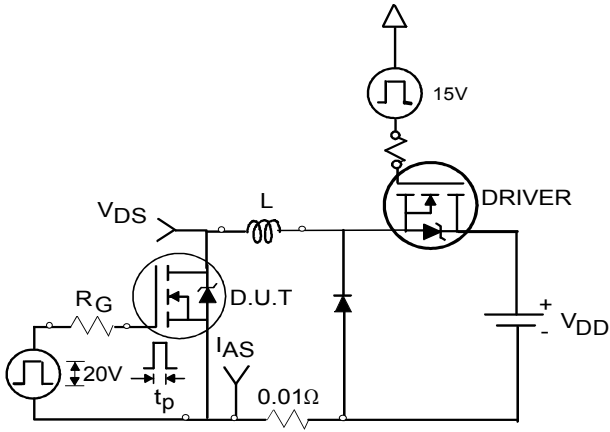
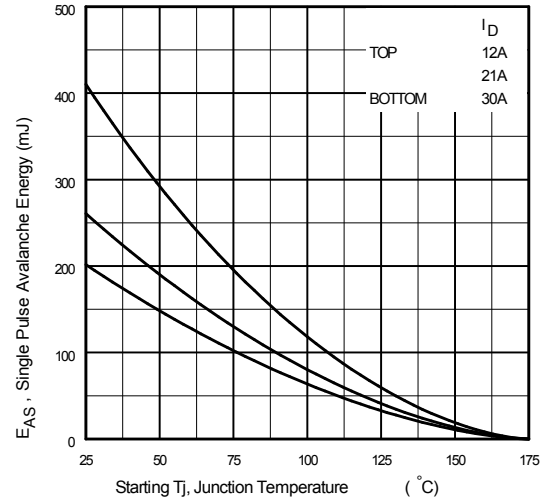
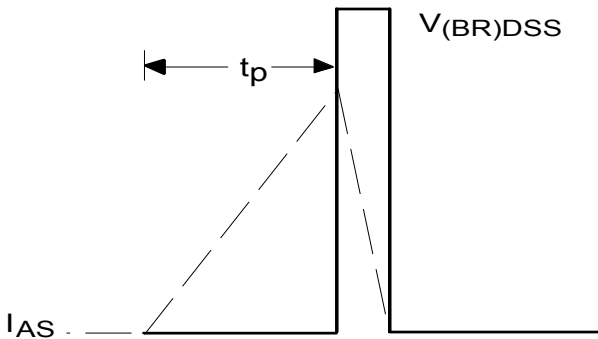
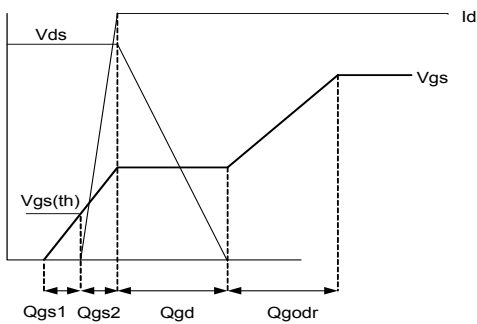
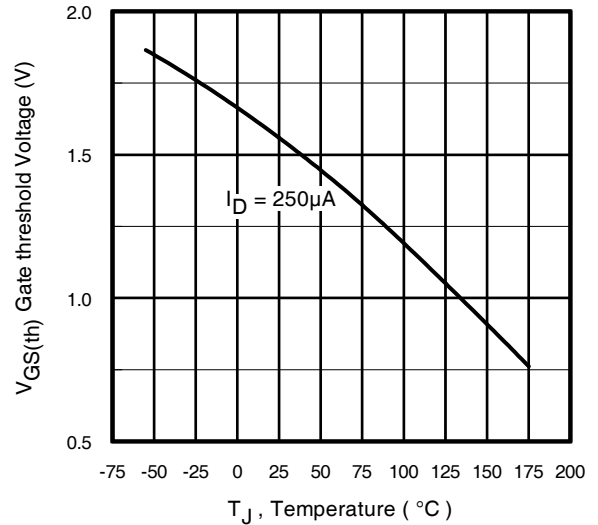
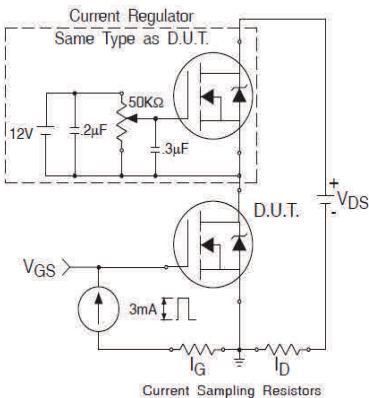

Fig 11. Maximum Effective Transient Thermal Impedance, Junction-to-Case

Fig 12a. Unclamped Inductive Test Circuit

Fig 12c. Maximum Avalanche Energy vs. Drain Current

Fig 12b. Unclamped Inductive Waveforms

Fig 13a. Gate Charge Waveform

Fig 14. Threshold Voltage Vs. Temperature

Fig 13b. Gate Charge Test Circuit

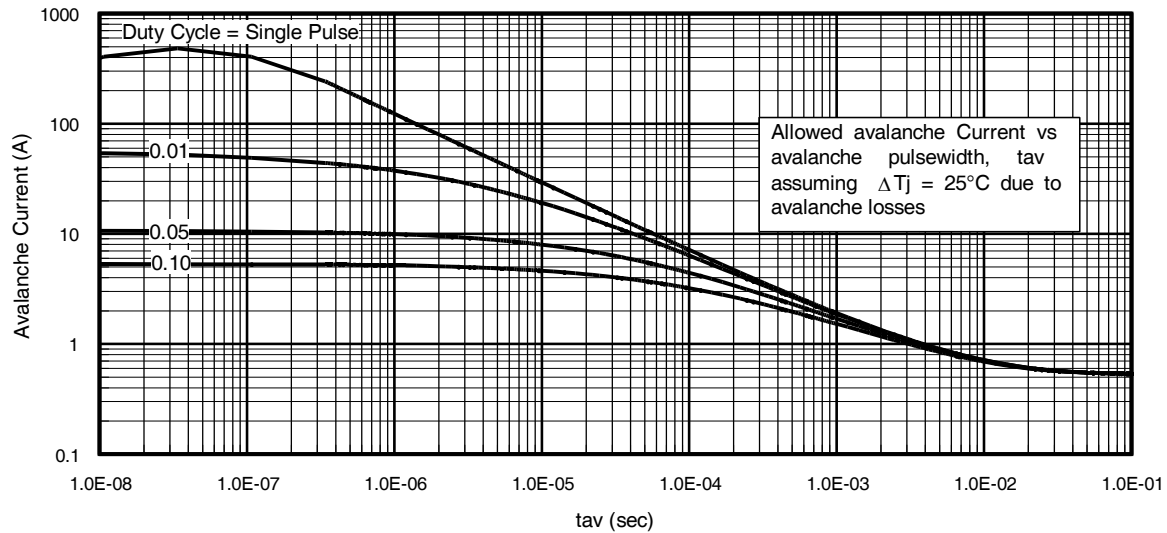

Fig 15. Typical Avalanche Current Vs. Pulse width

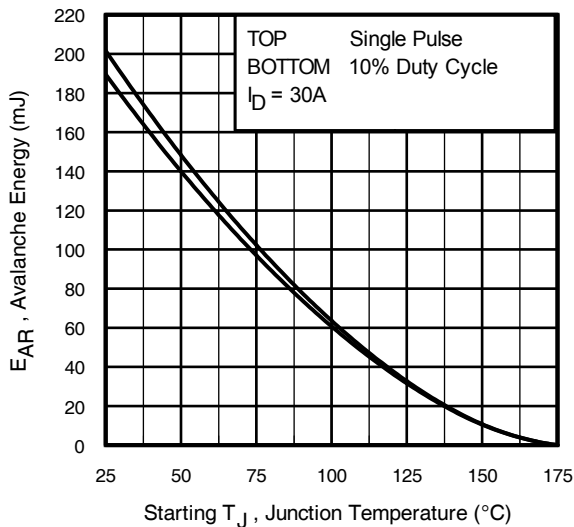

Fig 16. Maximum Avalanche Energy Vs. Temperature

Notes on Repetitive Avalanche Curves , Figures 15, 16:

(For further info, see AN-1005 at www.infineon.com)

1. Avalanche failures assumption:
Purely a thermal phenomenon and failure occurs at a temperature far in excess of T_{jmax} . This is validated for every part type.
2. Safe operation in Avalanche is allowed as long as T_{jmax} is not exceeded.
3. Equation below based on circuit and waveforms shown in Figures 12a, 12b.
4. $P_{D(ave)}$ = Average power dissipation per single avalanche pulse.
5. BV = Rated breakdown voltage (1.3 factor accounts for voltage increase during avalanche).
6. I_{av} = Allowable avalanche current.
7. ΔT = Allowable rise in junction temperature, not to exceed T_{jmax} (assumed as 25°C in Figure 15, 16).
 t_{av} = Average time in avalanche.
 D = Duty cycle in avalanche = $t_{av} \cdot f$
 $Z_{thJC}(D, t_{av})$ = Transient thermal resistance, see Figures 13)

$$P_{D(ave)} = 1/2 (1.3 \cdot BV \cdot I_{av}) = \Delta T / Z_{thJC}$$

$$I_{av} = 2\Delta T / [1.3 \cdot BV \cdot Z_{th}]$$

$$E_{AS(AR)} = P_{D(ave)} \cdot t_{av}$$



Fig 17. Peak Diode Recovery dv/dt Test Circuit for N-Channel HEXFET® Power MOSFETs



Fig 18a. Switching Time Test Circuit



Fig 18b. Switching Time Waveforms

D-Pak (TO-252AA) Package Outline (Dimensions are shown in millimeters (inches))

NOTES:

- 1.- DIMENSIONING AND TOLERANCING PER ASME Y14.5M-1994
- 2.- DIMENSION ARE SHOWN IN INCHES [MILLIMETERS]
- 3.- LEAD DIMENSION UNCONTROLLED IN L5.
- 4.- DIMENSION D1, E1, L3 & b3 ESTABLISH A MINIMUM MOUNTING SURFACE FOR THERMAL PAD.
- 5.- SECTION C-C DIMENSIONS APPLY TO THE FLAT SECTION OF THE LEAD BETWEEN .005 AND 0.10 [0.13 AND 0.25] FROM THE LEAD TIP.
- 6.- DIMENSION D & E DO NOT INCLUDE MOLD FLASH. MOLD FLASH SHALL NOT EXCEED .005 [0.13] PER SIDE. THESE DIMENSIONS ARE MEASURED AT THE OUTMOST EXTREMES OF THE PLASTIC BODY.
- 7.- DIMENSION b1 & c1 APPLIED TO BASE METAL ONLY.
- 8.- DATUM A & B TO BE DETERMINED AT DATUM PLANE H.
- 9.- OUTLINE CONFORMS TO JEDEC OUTLINE TO-252AA.

SYMBOL	DIMENSIONS				NOTES
	MILLIMETERS		INCHES		
	MIN.	MAX.	MIN.	MAX.	
A	2.18	2.39	.086	.094	
A1	-	0.13	-	.005	
b	0.64	0.89	.025	.035	
b1	0.65	0.79	.025	.031	7
b2	0.76	1.14	.030	.045	
b3	4.95	5.46	.195	.215	4
c	0.46	0.61	.018	.024	
c1	0.41	0.56	.016	.022	7
c2	0.46	0.89	.018	.035	
D	5.97	6.22	.235	.245	6
D1	5.21	-	.205	-	4
E	6.35	6.73	.250	.265	6
E1	4.32	-	.170	-	4
e	2.29 BSC		.090 BSC		
H	9.40	10.41	.370	.410	
L	1.40	1.78	.055	.070	
L1	2.74 BSC		.108 REF.		
L2	0.51 BSC		.020 BSC		
L3	0.89	1.27	.035	.050	4
L4	-	1.02	-	.040	
L5	1.14	1.52	.045	.060	3
φ	0"	10"	0"	10"	
φ1	0"	15"	0"	15"	
φ2	25"	35"	25"	35"	

LEAD ASSIGNMENTS
HEXFET

- 1.- GATE
- 2.- DRAIN
- 3.- SOURCE
- 4.- DRAIN

IGBT & CoPAK

- 1.- GATE
- 2.- COLLECTOR
- 3.- EMITTER
- 4.- COLLECTOR

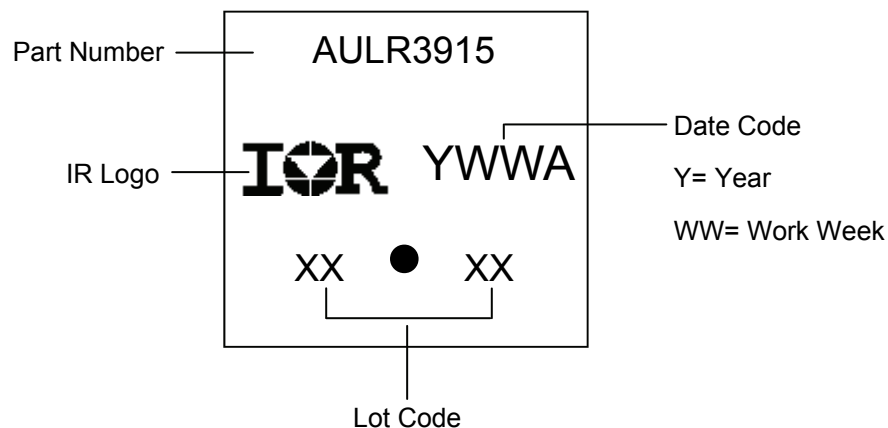
D-Pak (TO-252AA) Part Marking Information

Note: For the most current drawing please refer to IR website at <http://www.irf.com/package/>

D-Pak (TO-252AA) Tape & Reel Information (Dimensions are shown in millimeters (inches))

NOTES :

1. CONTROLLING DIMENSION : MILLIMETER.
2. ALL DIMENSIONS ARE SHOWN IN MILLIMETERS (INCHES).
3. OUTLINE CONFORMS TO EIA-481 & EIA-541.

NOTES :

1. OUTLINE CONFORMS TO EIA-481.

Note: For the most current drawing please refer to IR website at <http://www.irf.com/package/>

Qualification Information

Qualification Level		Automotive (per AEC-Q101)	
		Comments: This part number(s) passed Automotive qualification. Infineon's Industrial and Consumer qualification level is granted by extension of the higher Automotive level.	
Moisture Sensitivity Level		D-Pak	MSL1
ESD	Machine Model	Class M2 (+/- 200V) [†] AEC-Q101-002	
	Human Body Model	Class H1B (+/- 1000V) [†] AEC-Q101-001	
	Charged Device Model	Class C5 (+/- 2000V) [†] AEC-Q101-005	
RoHS Compliant		Yes	

† Highest passing voltage.

Revision History

Date	Comments
12/14/2015	<ul style="list-style-type: none"> Updated datasheet with corporate template Corrected ordering table on page 1.

Published by
Infineon Technologies AG
81726 München, Germany
 © Infineon Technologies AG 2015
All Rights Reserved.

IMPORTANT NOTICE

The information given in this document shall in no event be regarded as a guarantee of conditions or characteristics ("Beschaffungsgarantie"). With respect to any examples, hints or any typical values stated herein and/or any information regarding the application of the product, Infineon Technologies hereby disclaims any and all warranties and liabilities of any kind, including without limitation warranties of non-infringement of intellectual property rights of any third party.

In addition, any information given in this document is subject to customer's compliance with its obligations stated in this document and any applicable legal requirements, norms and standards concerning customer's products and any use of the product of Infineon Technologies in customer's applications.

The data contained in this document is exclusively intended for technically trained staff. It is the responsibility of customer's technical departments to evaluate the suitability of the product for the intended application and the completeness of the product information given in this document with respect to such application.

For further information on the product, technology, delivery terms and conditions and prices please contact your nearest Infineon Technologies office (www.infineon.com).

WARNINGS

Due to technical requirements products may contain dangerous substances. For information on the types in question please contact your nearest Infineon Technologies office.

Except as otherwise explicitly approved by Infineon Technologies in a written document signed by authorized representatives of Infineon Technologies, Infineon Technologies' products may not be used in any applications where a failure of the product or any consequences of the use thereof can reasonably be expected to result in personal injury.

X-ON Electronics

Largest Supplier of Electrical and Electronic Components

Click to view similar products for [MOSFET](#) category:

Click to view products by [Infineon](#) manufacturer:

Other Similar products are found below :

[614233C](#) [648584F](#) [IRFD120](#) [JANTX2N5237](#) [FCA20N60_F109](#) [FDZ595PZ](#) [2SK2545\(Q,T\)](#) [405094E](#) [423220D](#) [TPCC8103,L1Q\(CM](#)
[MIC4420CM-TR](#) [VN1206L](#) [614234A](#) [715780A](#) [NTNS3166NZT5G](#) [SSM6J414TU,LF\(T](#) [751625C](#) [BUK954R8-60E](#) [GROUP A 5962-](#)
[8877003PA](#) [NTE6400](#) [SQJ402EP-T1-GE3](#) [2SK2614\(TE16L1,Q\)](#) [2N7002KW-FAI](#) [DMN1017UCP3-7](#) [EFC2J004NUZTDG](#) [ECH8691-TL-W](#)
[FCAB21350L1](#) [P85W28HP2F-7071](#) [DMN1053UCP4-7](#) [NTE221](#) [NTE222](#) [NTE2384](#) [NTE2903](#) [NTE2941](#) [NTE2945](#) [NTE2946](#) [NTE2960](#)
[NTE2967](#) [NTE2969](#) [NTE2976](#) [NTE6400A](#) [NTE2910](#) [NTE2916](#) [NTE2956](#) [NTE2911](#) [DMN2080UCB4-7](#) [TK10A80W,S4X\(S](#)
[SSM6P54TU,LF](#) [SSM6P69NU,LF](#) [DMP22D4UFO-7B](#)