

Silicon RF Switching Diode

- For band switching in TV/VTR tuners and mobile applications
- Very low forward resistance (typ. 0.45 Ω @ 3 mA)
- Small capacitance
- Pb-free (RoHS compliant) package
- Qualified according AEC Q101

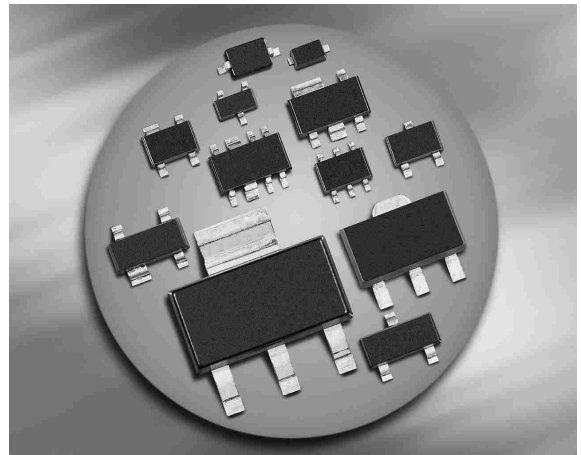

BA592
BA892/-02L
BA892-02V

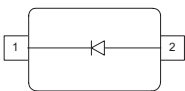

Type	Package	Configuration	L_S (nH)	Marking
BA592	SOD323	single	1.8	blue S
BA892	SCD80	single	0.6	AA
BA892-02L	TSLP-2-1	single, leadless	0.4	AA
BA892-02V	SC79	single	0.6	A

Maximum Ratings at $T_A = 25^\circ\text{C}$, unless otherwise specified

Parameter	Symbol	Value	Unit
Diode reverse voltage	V_R	35	V
Forward current	I_F	100	mA
Junction temperature	T_J	150	°C
Operating temperature range	T_{op}	-55 ... 125	
Storage temperature	T_{Stg}	-55 ... 150	

Thermal Resistance

Parameter	Symbol	Value	Unit
Junction - soldering point ¹⁾	R_{thJS}		K/W
BA592		≤ 135	
BA892, BA892-02V		≤ 120	
BA892-02L		≤ 70	

Electrical Characteristics at $T_A = 25^\circ\text{C}$, unless otherwise specified

Parameter	Symbol	Values			Unit
		min.	typ.	max.	

DC Characteristics

Reverse current $V_R = 20\text{ V}$	I_R	-	-	20	nA
Forward voltage $I_F = 100\text{ mA}$	V_F	-	-	1	V

¹⁾For calculation of R_{thJA} please refer to Application Note Thermal Resistance

Electrical Characteristics at $T_A = 25^\circ\text{C}$, unless otherwise specified

Parameter	Symbol	Values			Unit
		min.	typ.	max.	
AC Characteristics					
Diode capacitance $V_R = 1\text{ V}, f = 1\text{ MHz}$ $V_R = 3\text{ V}, f = 1\text{ MHz}$ $V_R = 0\text{ V}, f = 100\text{ MHz}$	C_T	0.65 0.6 -	0.92 0.85 1	1.4 1.1 -	pF
Reverse parallel resistance $V_R = 0\text{ V}, f = 100\text{ MHz}$	R_P	-	100	-	k Ω
Forward resistance $I_F = 3\text{ mA}, f = 100\text{ MHz}$ $I_F = 10\text{ mA}, f = 100\text{ MHz}$	r_f	- -	0.45 0.36	0.7 0.5	Ω
Charge carrier life time $I_F = 10\text{ mA}, I_R = 6\text{ mA}$, measured at $I_R = 3\text{ mA}$, $R_L = 100\ \Omega$	τ_{rr}	-	120	-	ns
I-region width	W_I	-	3	-	μm
Insertion loss ¹⁾ $I_F = 0.1\text{ mA}, f = 1.8\text{ GHz}$ $I_F = 3\text{ mA}, f = 1.8\text{ GHz}$ $I_F = 10\text{ mA}, f = 1.8\text{ GHz}$	I_L	- - -	0.1 0.5 0.4	- - -	dB
Isolation ¹⁾ $V_R = 0\text{ V}, f = 100\text{ MHz}$ $V_R = 0\text{ V}, f = 470\text{ MHz}$ $V_R = 0\text{ V}, f = 1\text{ GHz}$	I_{SO}	- - -	23.5 10.5 5.5	- - -	

¹BA892-02L in series configuration, $Z = 50\ \Omega$

Diode capacitance $C_T = f(V_R)$

$f = \text{Parameter}$

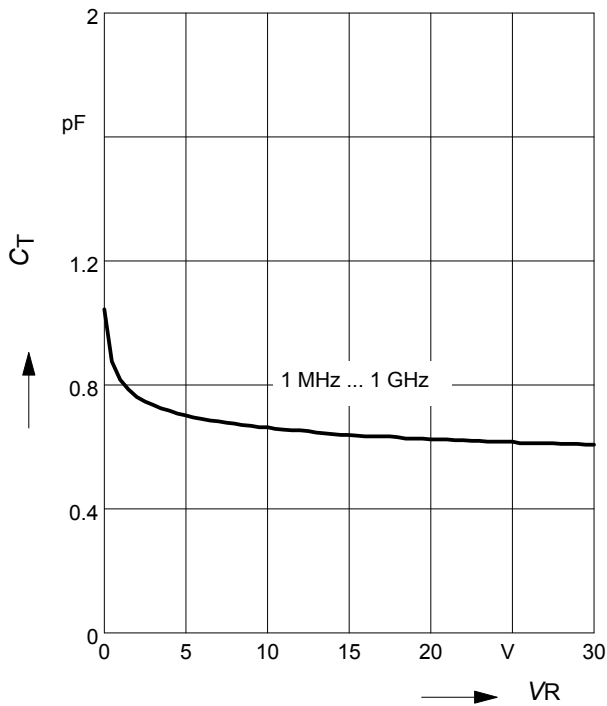

Reverse parallel resistance $R_P = f(V_R)$

$f = \text{Parameter}$

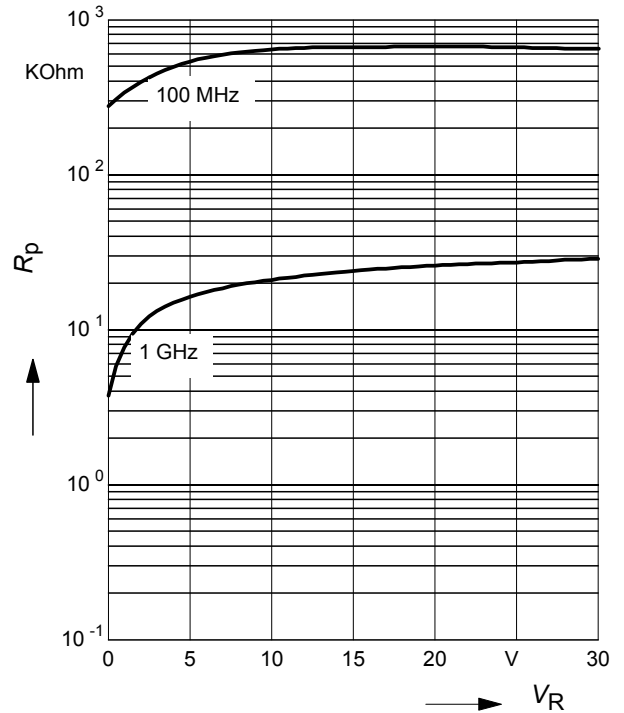

Forward resistance $r_f = f(I_F)$

$f = 100\text{MHz}$

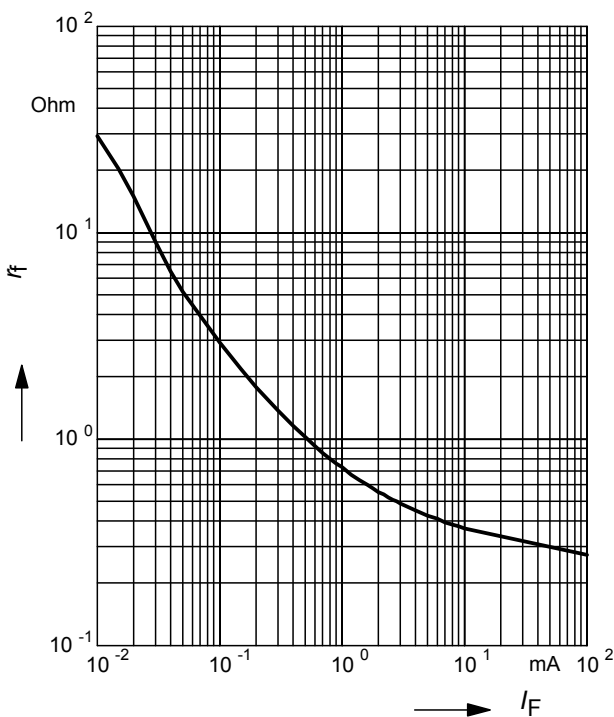

Forward current $I_F = f(V_F)$

$T_A = \text{Parameter}$

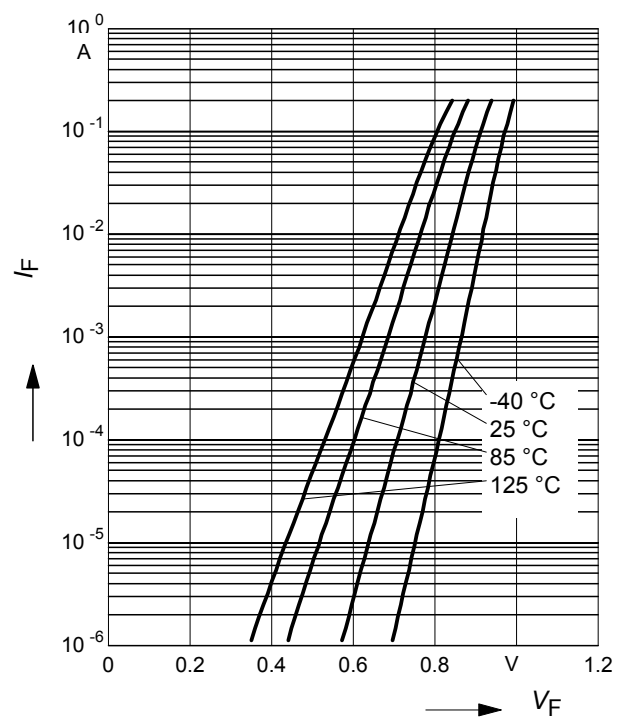

Insertion loss $I_L = -|S_{21}|^2 = f(f)$

I_F = Parameter

BA892-02L in series configuration, $Z = 50\Omega$

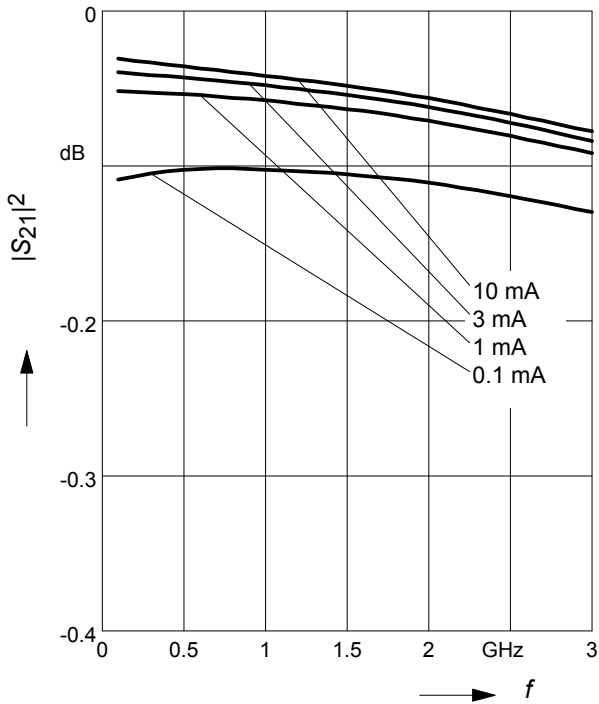

Isolation $I_{SO} = -|S_{21}|^2 = f(f)$

V_R = Parameter

BA892-02L in series configuration, $Z = 50\Omega$

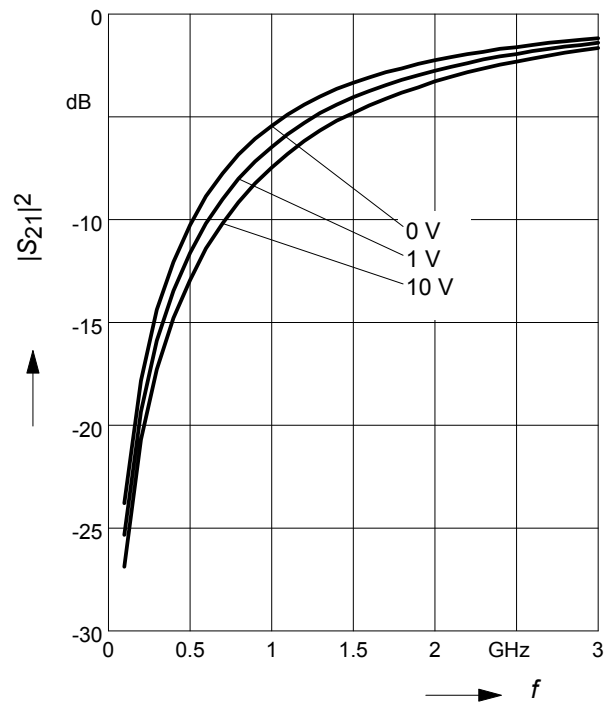

Package Outline

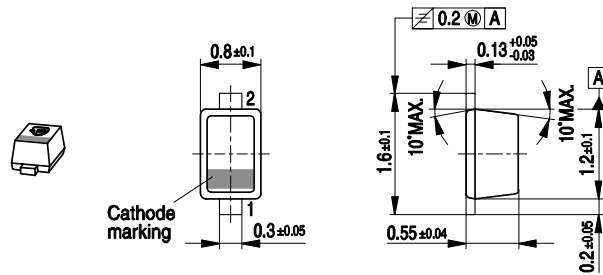

Foot Print

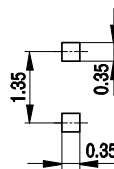

Marking Layout (Example)

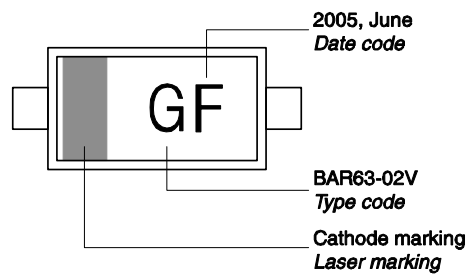

Standard Packing

- Reel ø180 mm = 3.000 Pieces/Reel
- Reel ø180 mm = 8.000 Pieces/Reel (2 mm Pitch)
- Reel ø330 mm = 10.000 Pieces/Reel

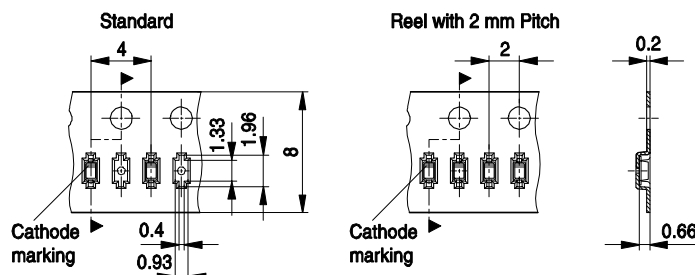

Package Outline

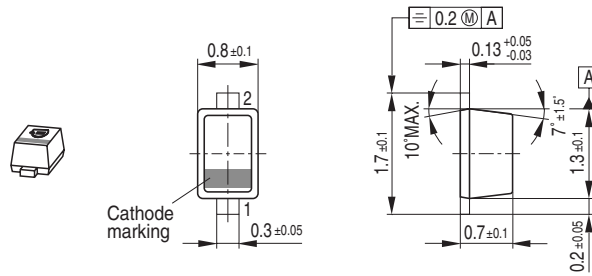

Foot Print

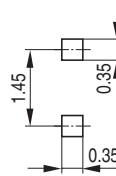

Marking Layout (Example)

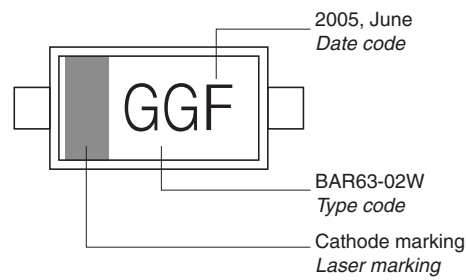

Standard Packing

Reel ø180 mm = 3.000 Pieces/Reel
 Reel ø180 mm = 8.000 Pieces/Reel (2 mm Pitch)
 Reel ø330 mm = 10.000 Pieces/Reel

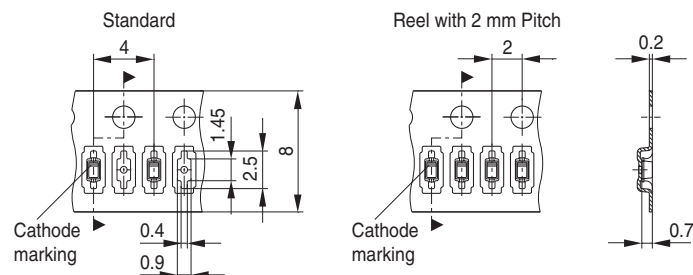

Date Code marking for discrete packages with one digit (SCD80, SC79, SC75¹⁾) CES-Code

Month	2003	2004	2005	2006	2007	2008	2009	2010	2011	2012	2013	2014
01	a	p	A	P	a	p	A	P	a	p	A	P
02	b	q	B	Q	b	q	B	Q	b	q	B	Q
03	c	r	C	R	c	r	C	R	c	r	C	R
04	d	s	D	S	d	s	D	S	d	s	D	S
05	e	t	E	T	e	t	E	T	e	t	E	T
06	f	u	F	U	f	u	F	U	f	u	F	U
07	g	v	G	V	g	v	G	V	g	v	G	V
08	h	x	H	X	h	x	H	X	h	x	H	X
09	j	y	J	Y	j	y	J	Y	j	y	J	Y
10	k	z	K	Z	k	z	K	Z	k	z	K	Z
11	l	2	L	4	l	2	L	4	l	2	L	4
12	n	3	N	5	n	3	N	5	n	3	N	5

1) New Marking Layout for SC75, implemented at October 2005.

Package Outline

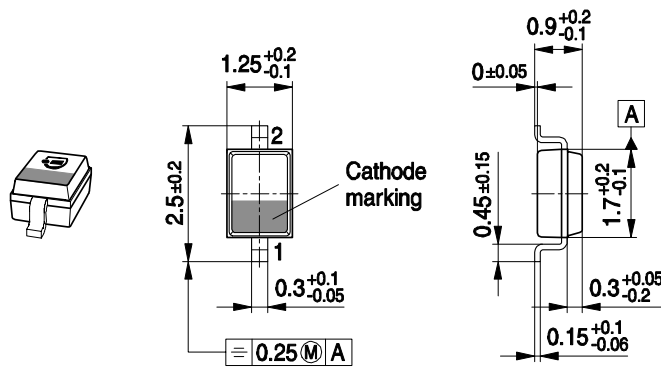

Foot Print

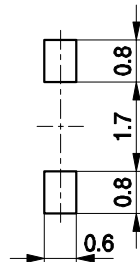

Marking Layout (Example)

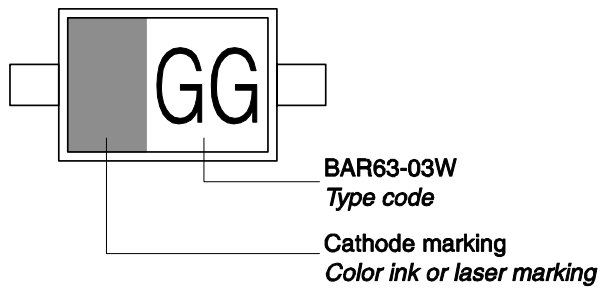

Standard Packing

Reel ø180 mm = 3.000 Pieces/Reel
 Reel ø330 mm = 10.000 Pieces/Reel

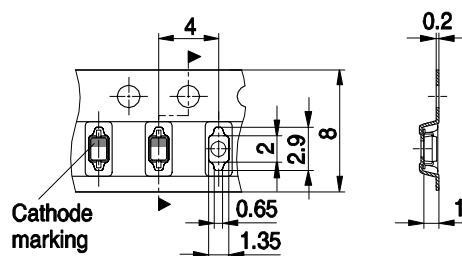

Package Outline

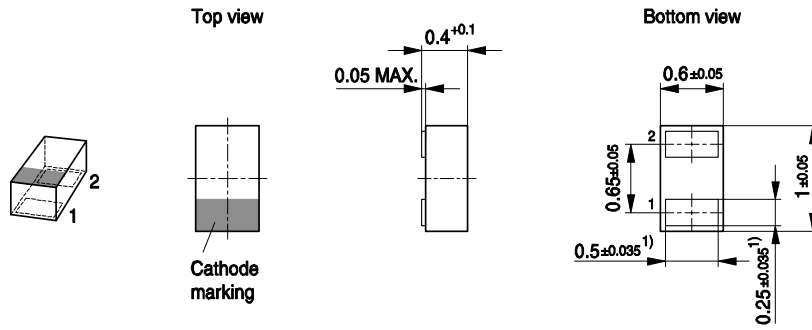

1) Dimension applies to plated terminal

Foot Print

For board assembly information please refer to Infineon website "Packages"

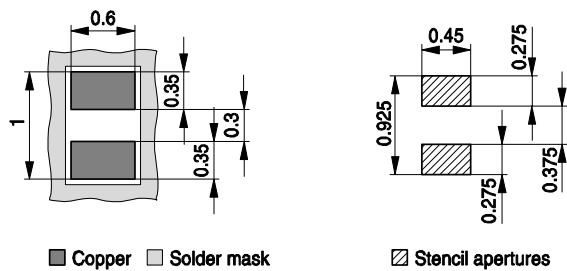

■ Copper □ Solder mask

▨ Stencil apertures

Marking Layout (Example)

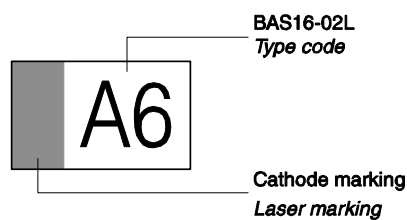

Standard Packing

Reel \varnothing 180 mm = 15.000 Pieces/Reel
 Reel \varnothing 330 mm = 50.000 Pieces/Reel (optional)

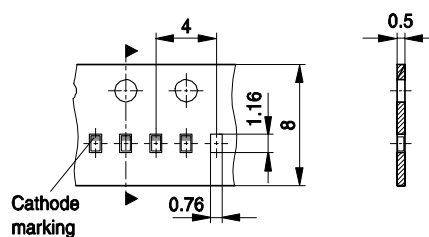

Edition 2009-11-16

**Published by
Infineon Technologies AG
81726 Munich, Germany**

**© 2009 Infineon Technologies AG
All Rights Reserved.**

Legal Disclaimer

The information given in this document shall in no event be regarded as a guarantee of conditions or characteristics. With respect to any examples or hints given herein, any typical values stated herein and/or any information regarding the application of the device, Infineon Technologies hereby disclaims any and all warranties and liabilities of any kind, including without limitation, warranties of non-infringement of intellectual property rights of any third party.

Information

For further information on technology, delivery terms and conditions and prices, please contact the nearest Infineon Technologies Office (www.infineon.com).

Warnings

Due to technical requirements, components may contain dangerous substances. For information on the types in question, please contact the nearest Infineon Technologies Office.

Infineon Technologies components may be used in life-support devices or systems only with the express written approval of Infineon Technologies, if a failure of such components can reasonably be expected to cause the failure of that life-support device or system or to affect the safety or effectiveness of that device or system. Life support devices or systems are intended to be implanted in the human body or to support and/or maintain and sustain and/or protect human life. If they fail, it is reasonable to assume that the health of the user or other persons may be endangered.

X-ON Electronics

Largest Supplier of Electrical and Electronic Components

Click to view similar products for [PIN Diodes](#) category:

Click to view products by [Infineon](#) manufacturer:

Other Similar products are found below :

[MA45471](#) [MA4SPS502](#) [APD2220-000](#) [APD0810-000](#) [MA4GP907](#) [MA4L032-186](#) [MA4L401-30](#) [MA4P606-258](#) [MA4P7435NM-1091T](#)
[MA4PK2000](#) [MA4PK2001](#) [MA4PK2004](#) [MADP-007167-12250T](#) [MADP-030025-13140P](#) [MA4SPS421](#) [MA4PBL027](#) [MA4P404-30](#)
[MA4AGFCP910](#) [MA4P7101F-1072T](#) [MA4L022-30](#) [MA47047-54](#) [BAR 89-02LRH E6327](#) [UM7108B](#) [UM9701](#) [1SV308,L3F](#) [UM9301SM](#)
[5082-3077](#) [GC4723-42](#) [MA4L011-1088](#) [MSW2001-200](#) [SMP1321-000](#) [M17X1008](#) [UM4010SM](#) [UM6002B](#) [UM7201SM](#) [UM7006A](#)
[UM7006B](#) [UM7108C](#) [GC4742-42](#) [MADP-000015-000030](#) [MGPN1503-C01A](#) [LXP1004-23-2](#) [MPP4201-206](#) [LXP1004-23-0](#) [MPP4202-206](#)
[MPP4205-206](#) [SMP1321-011LF](#) [MA4L021-1056](#) [MSW2031-203](#) [MLP7120-11](#)