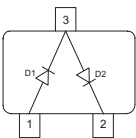
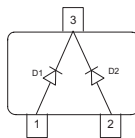
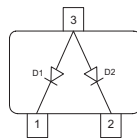
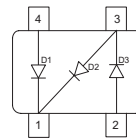

**Silicon PIN Diode**

- RF switch, RF attenuator for frequencies above 10 MHz
- Low distortion faktor
- Long-term stability of electrical characteristics
- Pb-free (RoHS compliant) package
- Qualified according AEC Q101

**BAR14-1**

**BAR15-1**

**BAR16-1**

**BAR61**

Type	Package	Configuration	$L_S$ (nH)	Marking
BAR14-1	SOT23	series	1.8	L7s
BAR15-1	SOT23	common cathode	1.8	L8s
BAR16-1	SOT23	common anode	1.8	L9s
BAR61	SOT143	PI element	2	61s

**Maximum Ratings at  $T_A = 25^\circ\text{C}$ , unless otherwise specified**

Parameter	Symbol	Value	Unit
Diode reverse voltage	$V_R$	100	V
Forward current	$I_F$	140	mA
Total power dissipation $T_S \leq 65^\circ\text{C}$	$P_{tot}$	250	mW
Junction temperature	$T_j$	150	°C
Operating temperature range	$T_{op}$	-55 ... 125	
Storage temperature	$T_{stg}$	-55 ... 150	

**Thermal Resistance**

Parameter	Symbol	Value	Unit
Junction - soldering point <sup>1)</sup>	$R_{thJS}$	$\leq 340$	K/W

<sup>1)</sup>For calculation of  $R_{thJA}$  please refer to Application Note Thermal Resistance

**Electrical Characteristics at  $T_A = 25^\circ\text{C}$ , unless otherwise specified**

Parameter	Symbol	Values			Unit
		min.	typ.	max.	
<b>DC Characteristics</b>					
Reverse current $V_R = 50\text{ V}$ $V_R = 100\text{ V}$	$I_R$	-	-	100 1000	nA
Forward voltage $I_F = 100\text{ mA}$	$V_F$	-	1.05	1.25	V
<b>AC Characteristics</b>					
Diode capacitance $V_R = 0\text{ V}, f = 100\text{ MHz}$ $V_R = 50\text{ V}, f = 1\text{ MHz}$	$C_T$	-	0.2 0.25	0.5 0.5	pF
Zero bias conductance $V_R = 0\text{ V}, f = 100\text{ MHz}$	$g_P$	-	50	100	$\mu\text{S}$
Forward resistance $I_F = 0.01\text{ mA}, f = 100\text{ MHz}$ $I_F = 0.1\text{ mA}, f = 100\text{ MHz}$ $I_F = 1\text{ mA}, f = 100\text{ MHz}$ $I_F = 10\text{ mA}, f = 100\text{ MHz}$	$r_f$	- 300 35 5.5	2600 470 55 8	4200 - 85 12	$\Omega$
Charge carrier life time $I_F = 10\text{ mA}, I_R = 6\text{ mA}$ , measured at $I_R = 3\text{ mA}$ , $R_L = 100\ \Omega$	$\tau_{rr}$	700	1000	-	ns
I-region width	$W_I$	-	146	-	$\mu\text{m}$

**Diode capacitance  $C_T = f(V_R)$**

$f =$  Parameter

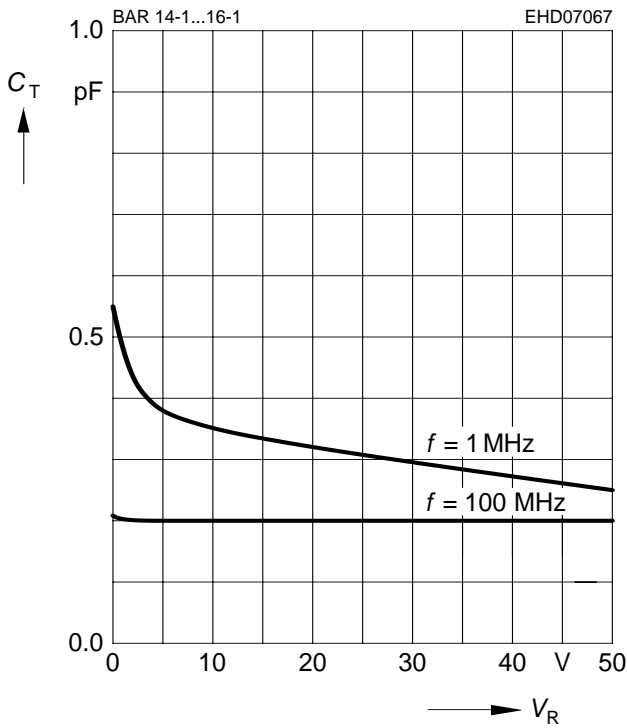

**Forward resistance  $r_f = f(I_F)$**

$f = 100\text{MHz}$

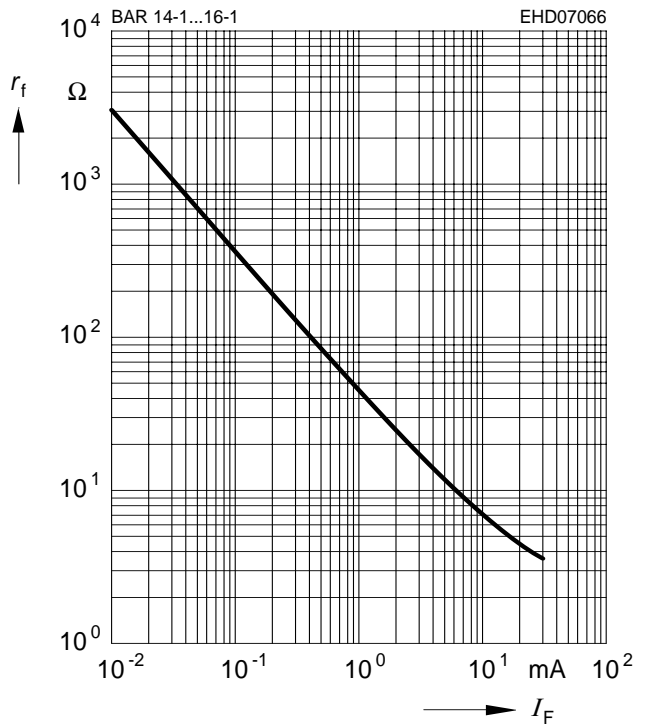

**Forward current  $I_F = f(V_F)$**

$T_A = 25^\circ\text{C}$

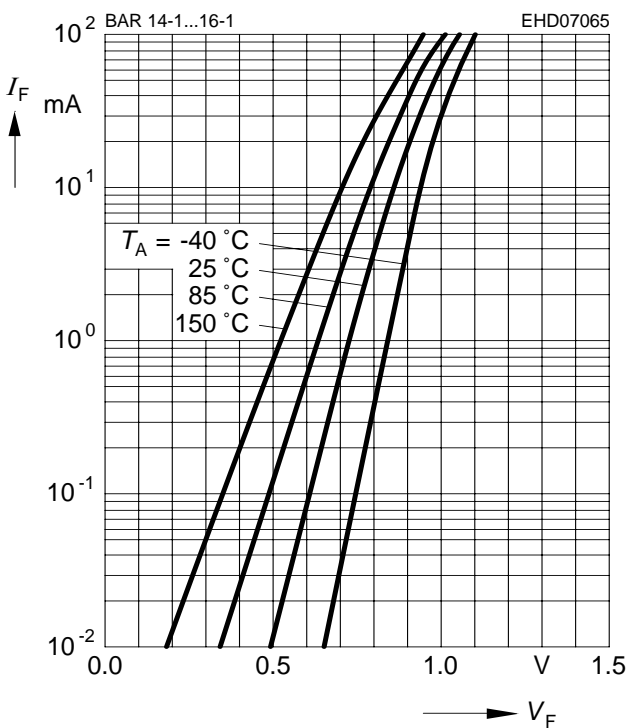

**Forward current  $I_F = f(T_S)$**

BAR14-1, BAR15-1, BAR16-1

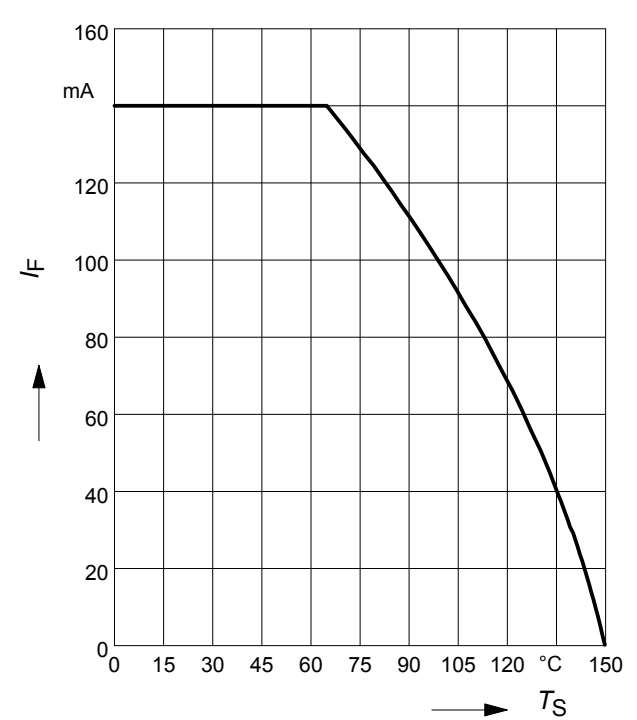

Application circuit for attenuation networks with diode BAR61

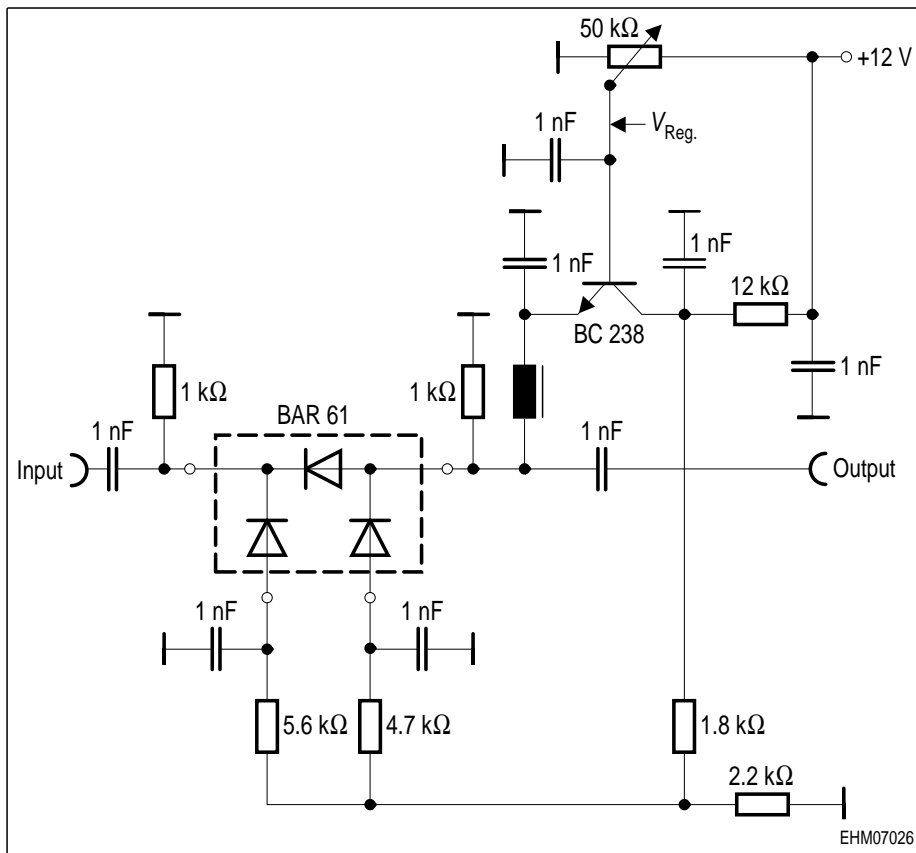

Package Outline

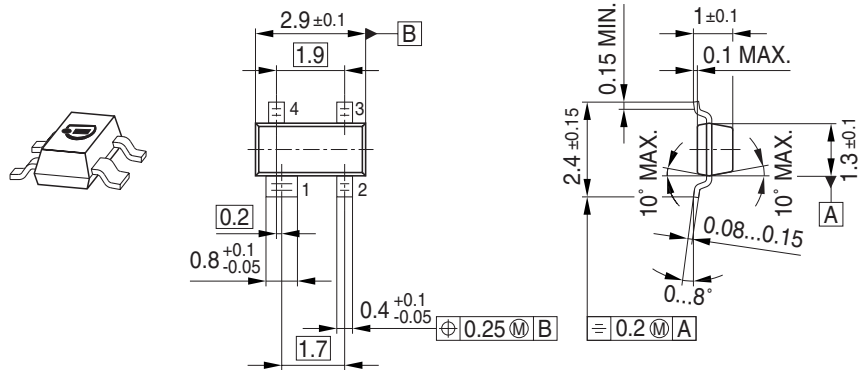

Foot Print

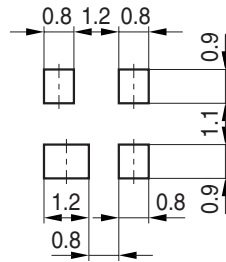

Marking Layout (Example)

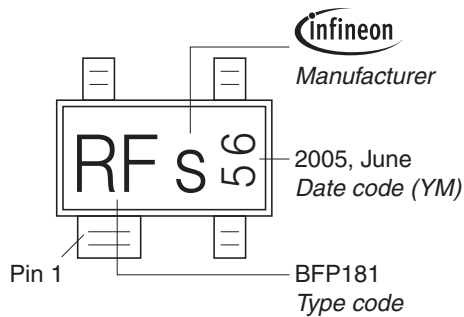

Standard Packing

Reel ø180 mm = 3.000 Pieces/Reel  
 Reel ø330 mm = 10.000 Pieces/Reel

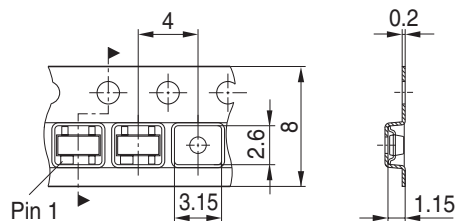

Package Outline



1) Lead width can be 0.6 max. in dambar area

Foot Print



Marking Layout (Example)



Standard Packing

Reel  $\varnothing$ 180 mm = 3.000 Pieces/Reel  
 Reel  $\varnothing$ 330 mm = 10.000 Pieces/Reel



**Edition 2009-11-16**

**Published by  
Infineon Technologies AG  
81726 Munich, Germany**

**© 2009 Infineon Technologies AG  
All Rights Reserved.**

### **Legal Disclaimer**

The information given in this document shall in no event be regarded as a guarantee of conditions or characteristics. With respect to any examples or hints given herein, any typical values stated herein and/or any information regarding the application of the device, Infineon Technologies hereby disclaims any and all warranties and liabilities of any kind, including without limitation, warranties of non-infringement of intellectual property rights of any third party.

### **Information**

For further information on technology, delivery terms and conditions and prices, please contact the nearest Infineon Technologies Office ([www.infineon.com](http://www.infineon.com)).

### **Warnings**

Due to technical requirements, components may contain dangerous substances. For information on the types in question, please contact the nearest Infineon Technologies Office.

Infineon Technologies components may be used in life-support devices or systems only with the express written approval of Infineon Technologies, if a failure of such components can reasonably be expected to cause the failure of that life-support device or system or to affect the safety or effectiveness of that device or system. Life support devices or systems are intended to be implanted in the human body or to support and/or maintain and sustain and/or protect human life. If they fail, it is reasonable to assume that the health of the user or other persons may be endangered.

## X-ON Electronics

Largest Supplier of Electrical and Electronic Components

*Click to view similar products for [PIN Diodes](#) category:*

*Click to view products by [Infineon](#) manufacturer:*

Other Similar products are found below :

[MA45471](#) [MA4SPS502](#) [APD2220-000](#) [APD0810-000](#) [MA4GP907](#) [MA4L032-186](#) [MA4L401-30](#) [MA4P606-258](#) [MA4P7435NM-1091T](#)  
[MA4PK2000](#) [MA4PK2001](#) [MA4PK2004](#) [MADP-007167-12250T](#) [MADP-030025-13140P](#) [MA4SPS421](#) [MA4PBL027](#) [MA4P404-30](#)  
[MA4AGFCP910](#) [MA4P7101F-1072T](#) [MA4L022-30](#) [MA47047-54](#) [BAR 89-02LRH E6327](#) [UM7108B](#) [UM9701](#) [1SV308,L3F](#) [UM9301SM](#)  
[5082-3077](#) [GC4723-42](#) [MA4L011-1088](#) [MSW2001-200](#) [SMP1321-000](#) [M17X1008](#) [UM4010SM](#) [UM6002B](#) [UM7201SM](#) [UM7006A](#)  
[UM7006B](#) [UM7108C](#) [GC4742-42](#) [MADP-000015-000030](#) [MGPN1503-C01A](#) [LXP1004-23-2](#) [MPP4201-206](#) [LXP1004-23-0](#) [MPP4202-206](#)  
[MPP4205-206](#) [SMP1321-011LF](#) [MA4L021-1056](#) [MSW2031-203](#) [MLP7120-11](#)