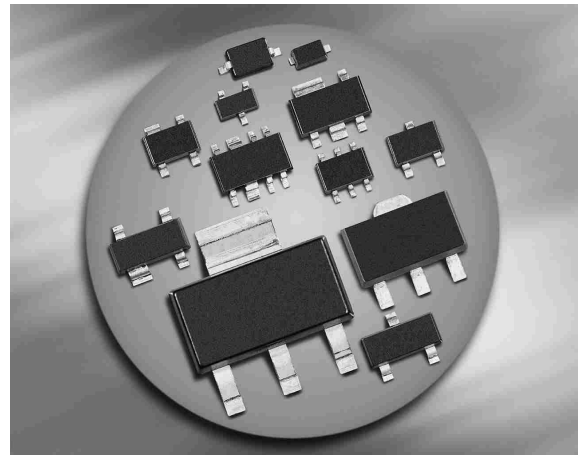
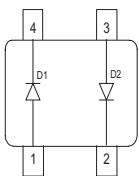
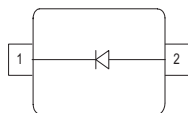
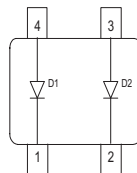
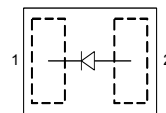
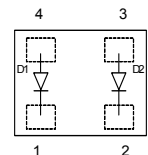
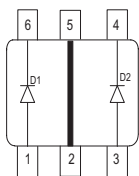

**Silicon Schottky Diode**

- Low barrier diode for detectors up to GHz frequencies
- Pb-free (RoHS compliant) package

**BAT62**

**BAT62-03W  
BAT62-02V  
BAT62-02W**

**BAT62-07W**

**BAT62-02L  
BAT62-02LS**

**BAT62-07L4**

**BAT62-09S**

**ESD (Electrostatic discharge) sensitive device, observe handling precaution!**

Type	Package	Configuration	$L_S$ (nH)	Marking
BAT62-02W**	SCD80	single	0.6	62
BAT62	SOT143	anti-parallel pair	2	62s
BAT62-02L	TSLP-2-1	single, leadless	0.4	L
BAT62-02LS*	TSSLP-2-1	single, leadless	0.2	U
BAT62-02V	SC79	single	0.6	k
BAT62-03W	SOD323	single	1.8	white L
BAT62-07L4	TSLP-4-4	parallel pair, leadless	0.4	62
BAT62-07W	SOT343	parallel pair	1.8	62s
BAT62-09S	SOT363	parallel high, high isolation	1.6	69s

\* Preliminary Data

\*\* Not for new design

**Maximum Ratings** at  $T_A = 25\text{ °C}$ , unless otherwise specified

Parameter	Symbol	Value	Unit
Diode reverse voltage	$V_R$	40	V
Forward current	$I_F$	20	mA
Total power dissipation BAT62, $T_S \leq 85\text{ °C}$ BAT62-02L, -07L4, -03W, $T_S \leq 108\text{ °C}$ BAT62-02W, -02V, $T_S \leq 109\text{ °C}$ BAT62-07W, $T_S \leq 103\text{ °C}$ BAT62-09S, $T_S \leq 105\text{ °C}$	$P_{tot}$	100 100 100 100 100	
Junction temperature	$T_j$	150	°C
Storage temperature	$T_{stg}$	-55 ... 150	

**Thermal Resistance**

Parameter	Symbol	Value	Unit
Junction - soldering point <sup>1)</sup> BAT62 BAT62-02L, -07L4, -03W BAT62-02W, 02V BAT62-07W BAT62-09S	$R_{thJS}$	$\leq 650$ $\leq 420$ $\leq 410$ $\leq 470$ $\leq tbd$	

**Electrical Characteristics** at  $T_A = 25\text{ °C}$ , unless otherwise specified

Parameter	Symbol	Values			Unit
		min.	typ.	max.	
Reverse current $V_R = 40\text{ V}$	$I_R$	-	-	10	$\mu\text{A}$
Forward voltage $I_F = 2\text{ mA}$	$V_F$	-	0.58	1	V
Forward voltage matching <sup>2)</sup> $I_F = 2\text{ mA}$	$\Delta V_F$	-	-	20	mV

<sup>1)</sup>For calculation of  $R_{thJA}$  please refer to Application Note AN077 (Thermal Resistance Calculation)

<sup>2)</sup> $\Delta V_F$  is the difference between lowest and highest  $V_F$  in a multiple diode component.

**Electrical Characteristics** at  $T_A = 25\text{ °C}$ , unless otherwise specified

Parameter	Symbol	Values			Unit
		min.	typ.	max.	
<b>AC Characteristics</b>					
Diode capacitance $V_R = 0\text{ V}, f = 1\text{ MHz}$	$C_T$	-	0.35	0.6	pF
Differential resistance $V_R = 0\text{ V}, f = 10\text{ kHz}$	$R_0$	-	225	-	k $\Omega$

**Diode capacitance  $C_T = f(V_R)$**

$f = 1\text{MHz}$

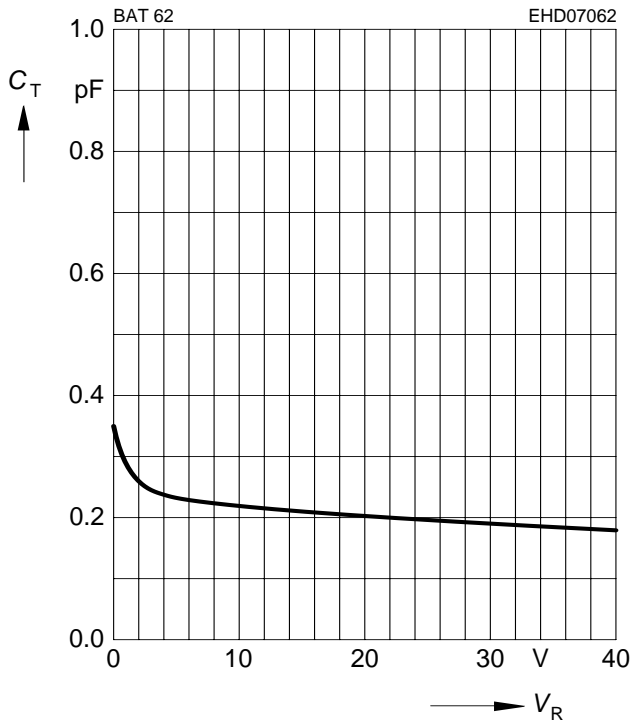

**Reverse current  $I_R = f(V_R)$**

$T_A = \text{Parameter}$

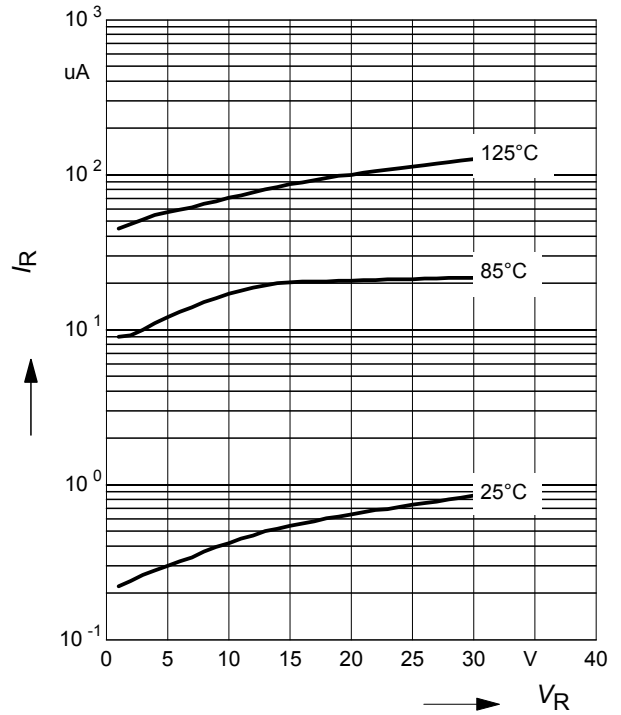

**Forward current  $I_F = f(V_F)$**

$T_A = \text{Parameter}$

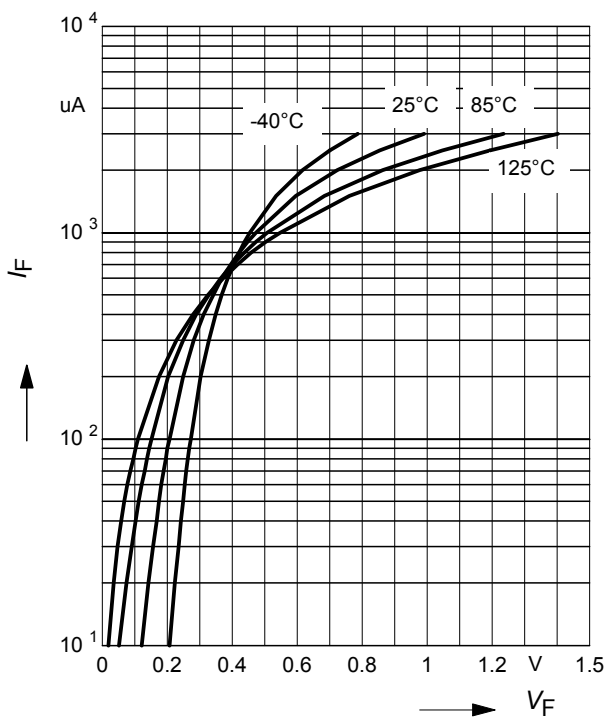

**Forward current  $I_F = f(T_S)$**

BAT62

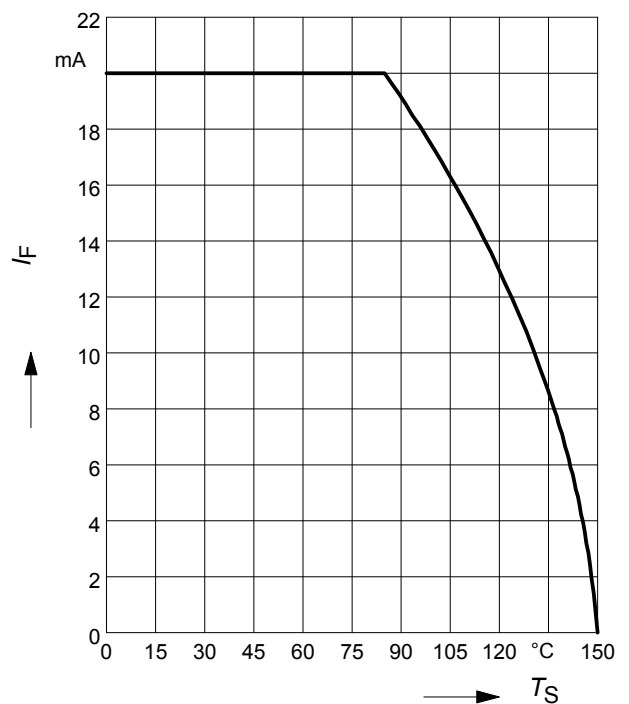

Forward current  $I_F = f(T_S)$

BAT62-02L, -07L4

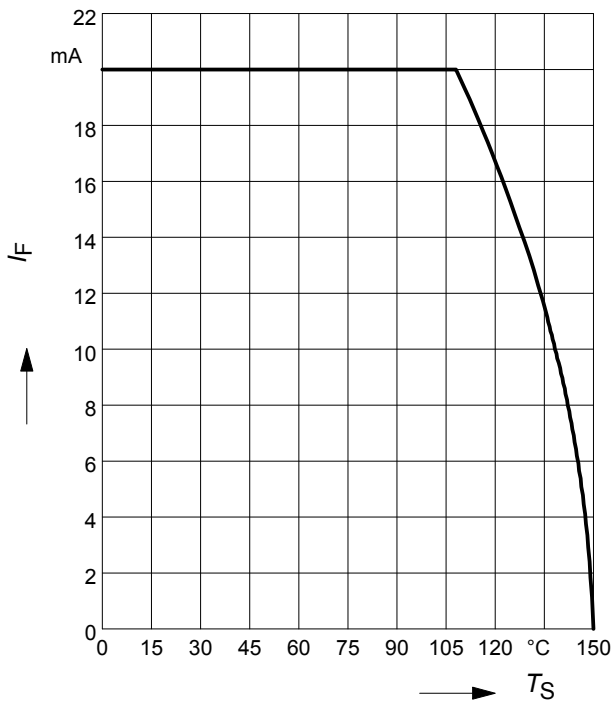

Forward current  $I_F = f(T_S)$

BAT62-02W, -02V

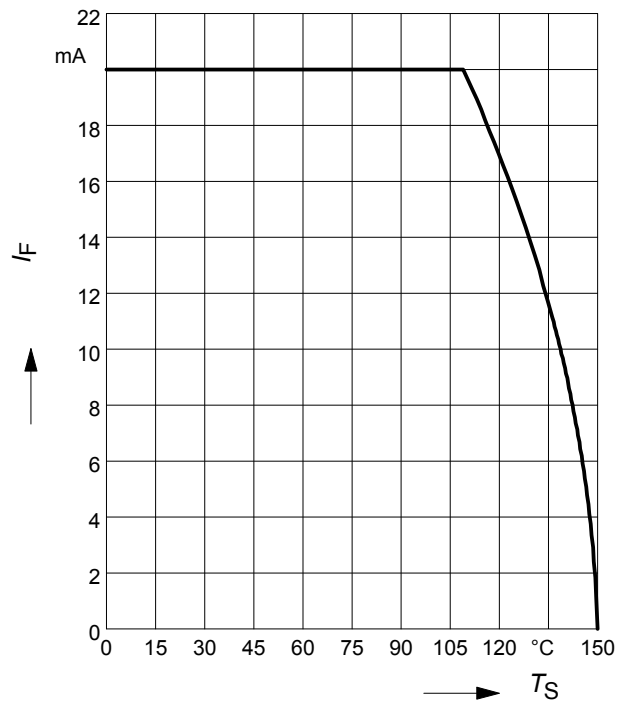

Forward current  $I_F = f(T_S)$

BAT62-03W

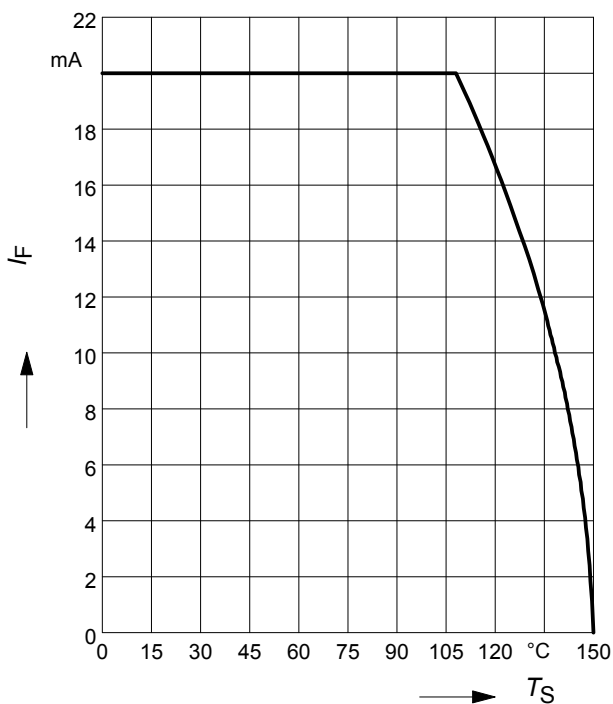

Forward current  $I_F = f(T_S)$

BAT62-07W

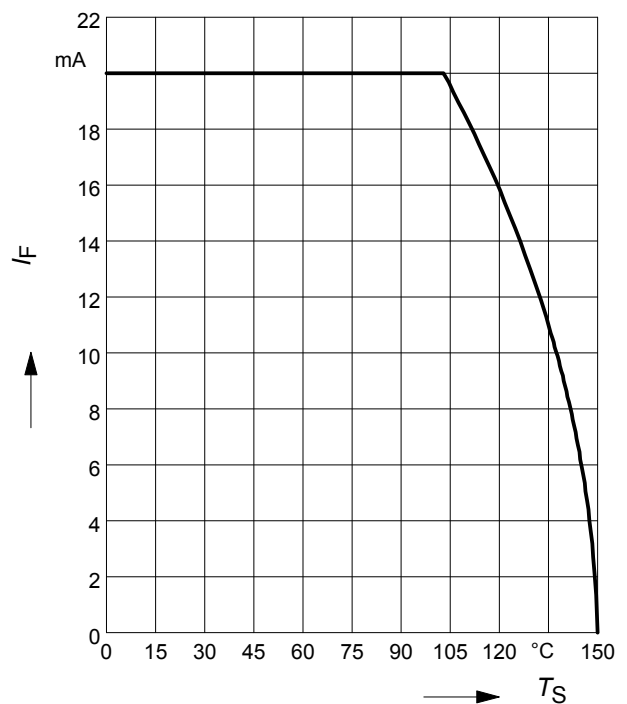

**Permissible Puls Load  $R_{thJS} = f(t_p)$**

BAT62

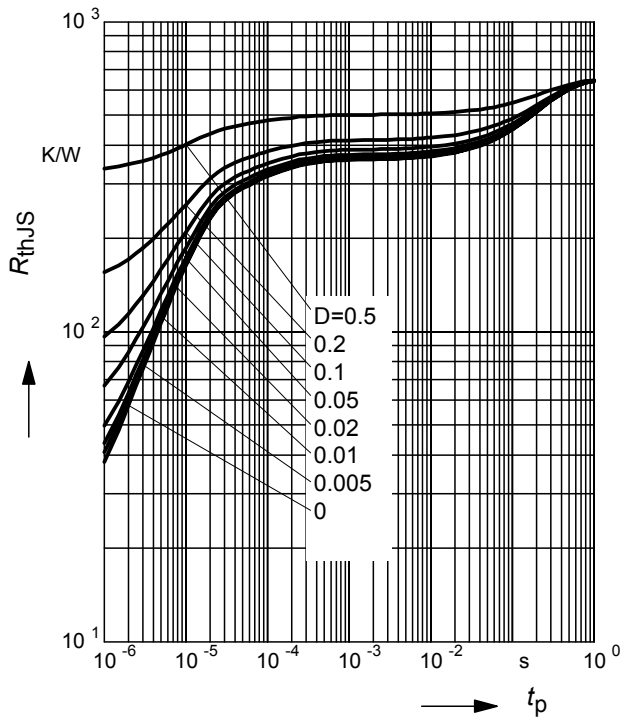

**Permissible Pulse Load**

$I_{Fmax} / I_{FDC} = f(t_p)$

BAT62

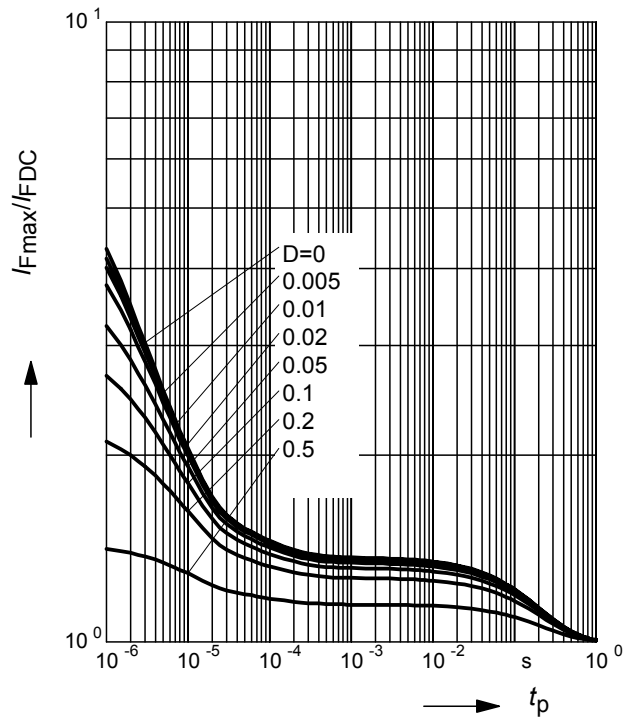

**Permissible Puls Load  $R_{thJS} = f(t_p)$**

BAT62-02L, -07L4

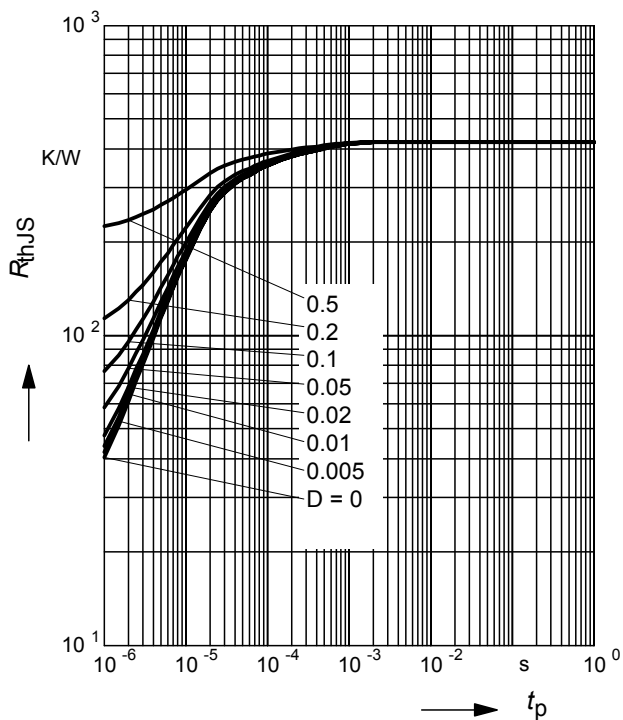

**Permissible Pulse Load**

$I_{Fmax} / I_{FDC} = f(t_p)$

BAT62-02L, -07L4

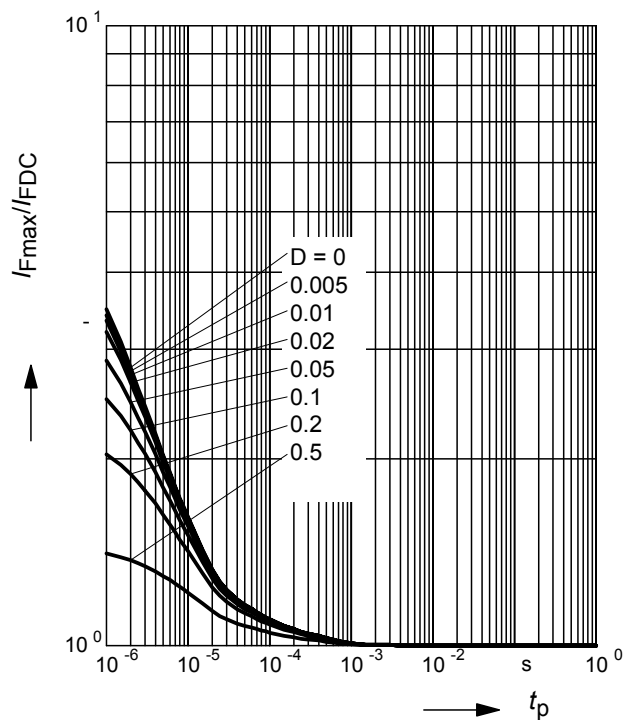

**Permissible Puls Load  $R_{thJS} = f(t_p)$**

BAT62-02W, 02V

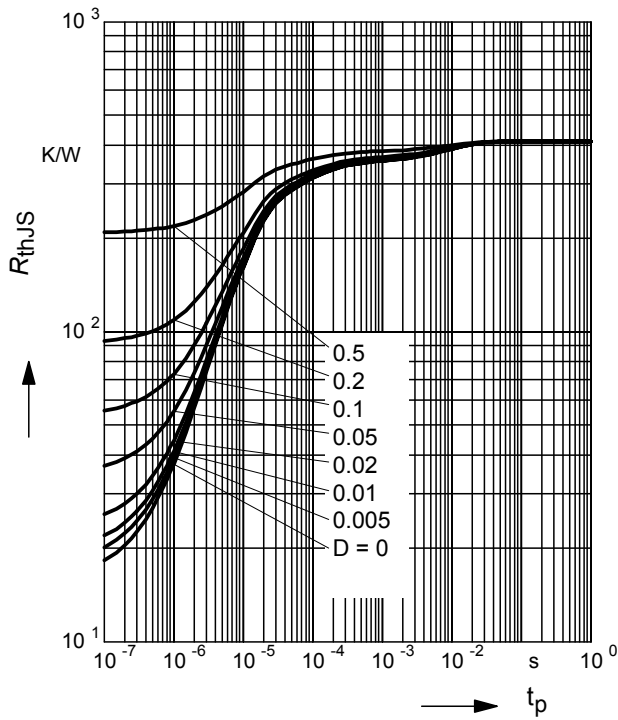

**Permissible Pulse Load**

$I_{Fmax} / I_{FDC} = f(t_p)$

BAT62-02W, -02V

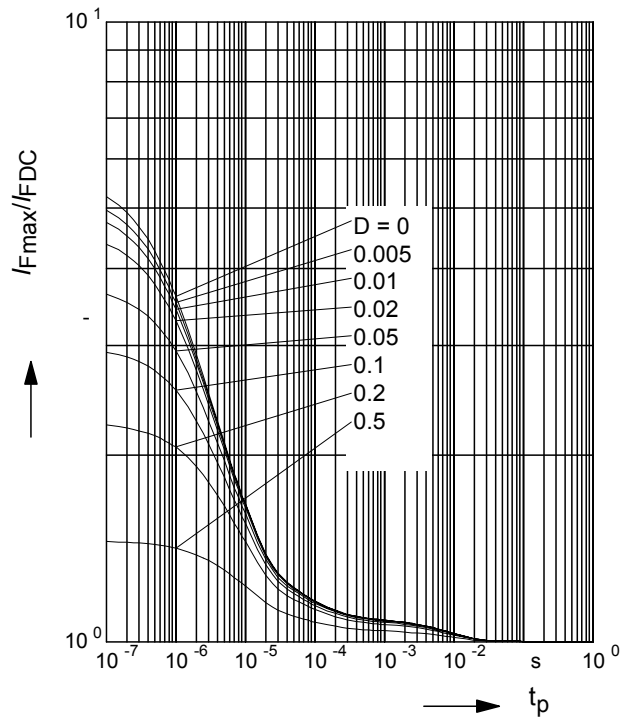

**Permissible Puls Load  $R_{thJS} = f(t_p)$**

BAT62-03W

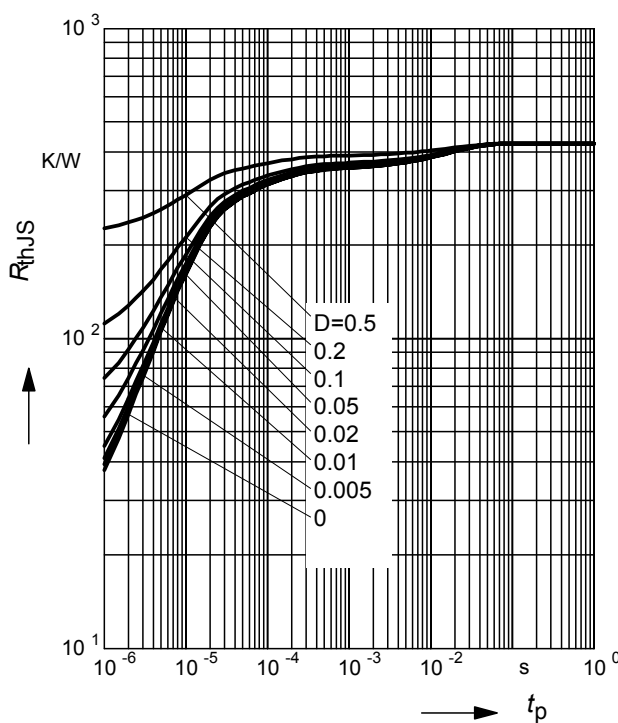

**Permissible Pulse Load**

$I_{Fmax} / I_{FDC} = f(t_p)$

BAT62-03W

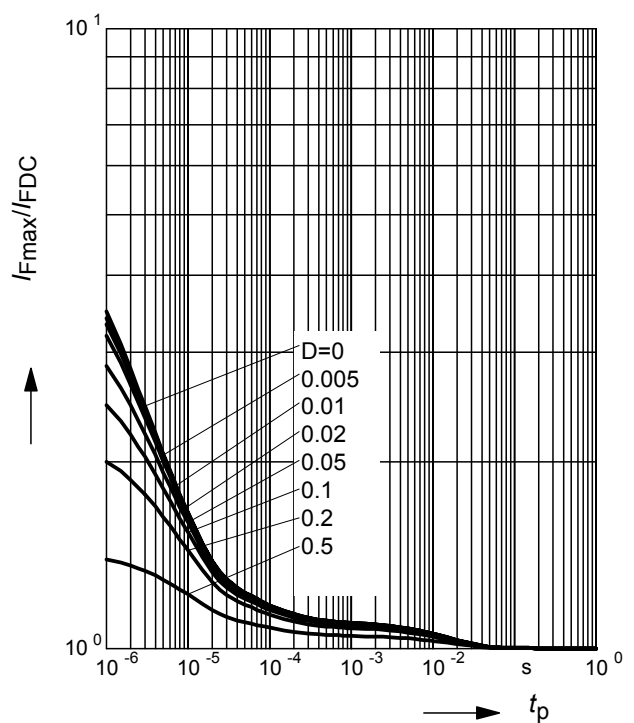

**Permissible Puls Load  $R_{thJS} = f(t_p)$**

BAT62-07W

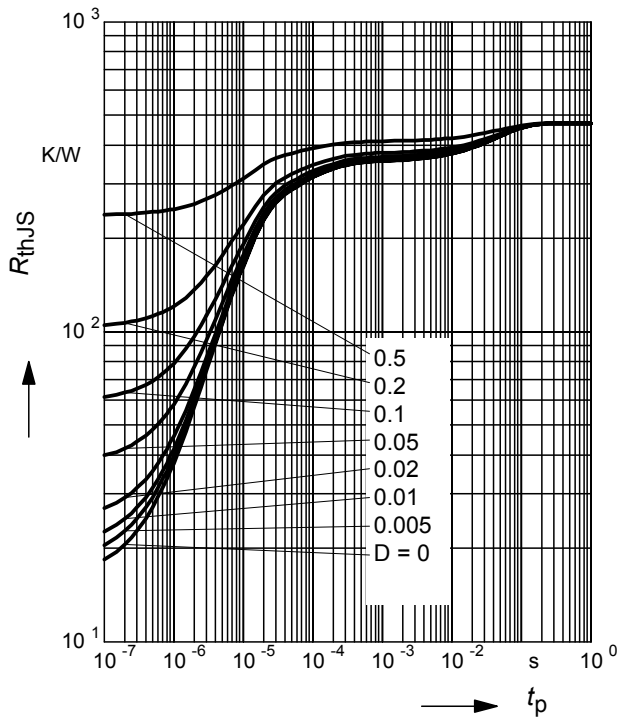

**Permissible Pulse Load**

$I_{Fmax} / I_{FDC} = f(t_p)$

BAT62-07W

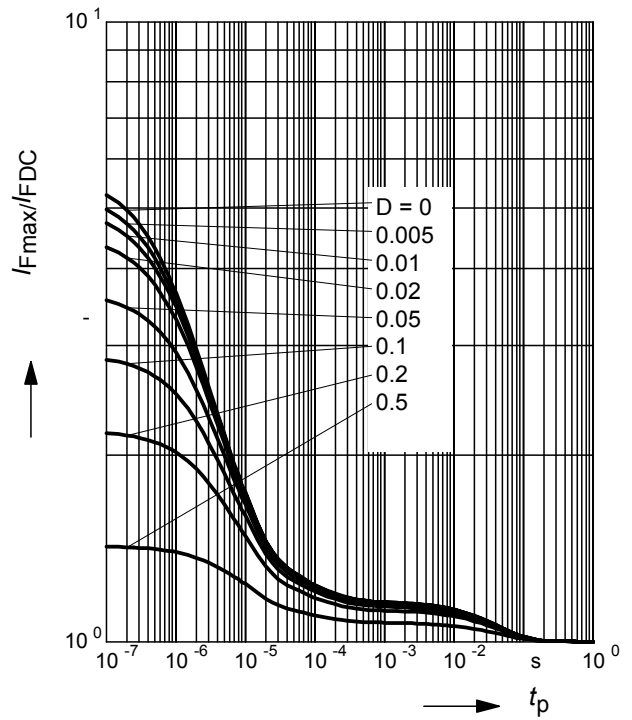

**Rectifier voltage  $V_{out} = f(V_{in})$**

$f = 900\text{MHz}$

$R_L = \text{Parameter in } k\Omega$

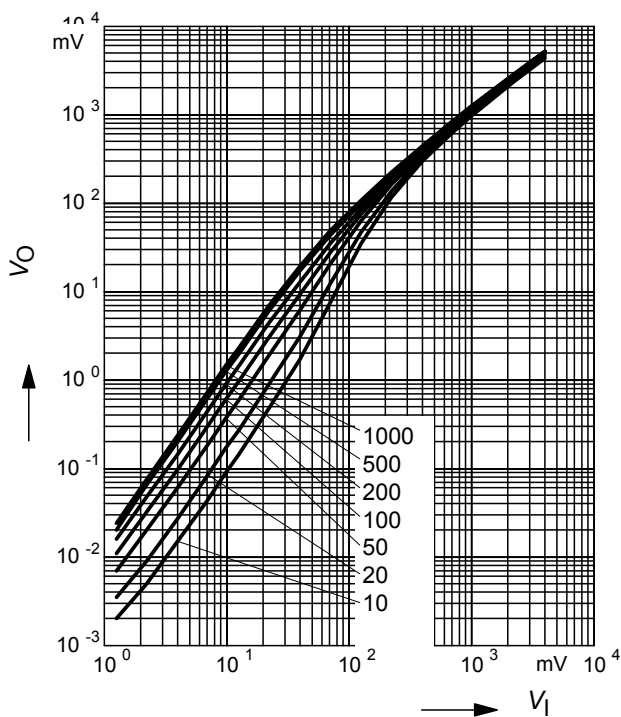

**Testcircuit**

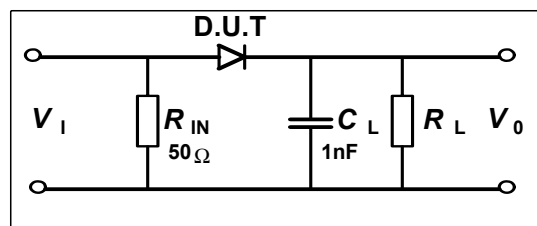



### Package Outline



### Foot Print



### Marking Layout (Example)

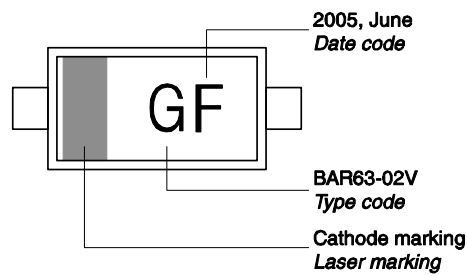

### Standard Packing

Reel  $\varnothing$ 180 mm = 3.000 Pieces/Reel  
 Reel  $\varnothing$ 180 mm = 8.000 Pieces/Reel (2 mm Pitch)  
 Reel  $\varnothing$ 330 mm = 10.000 Pieces/Reel

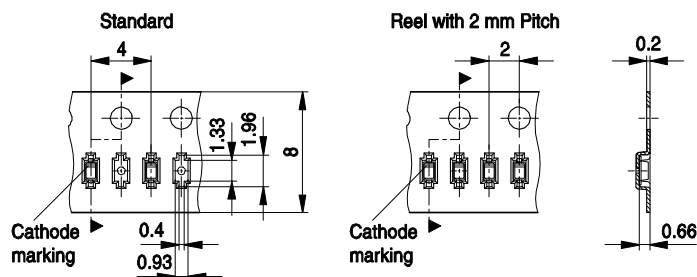

Package Outline

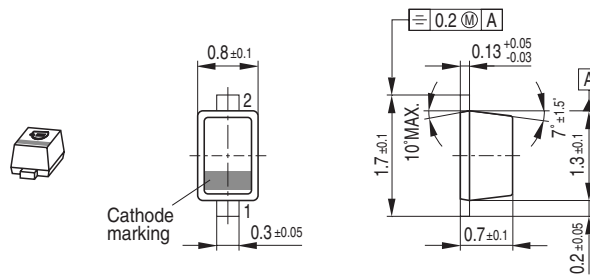

Foot Print

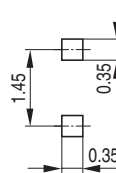

Marking Layout (Example)

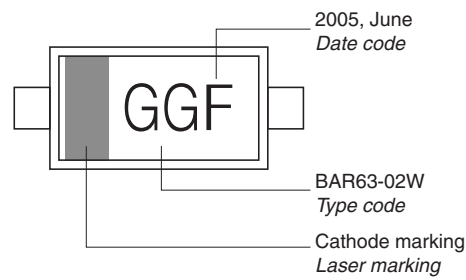

Standard Packing

Reel  $\varnothing$ 180 mm = 3.000 Pieces/Reel  
 Reel  $\varnothing$ 180 mm = 8.000 Pieces/Reel (2 mm Pitch)  
 Reel  $\varnothing$ 330 mm = 10.000 Pieces/Reel

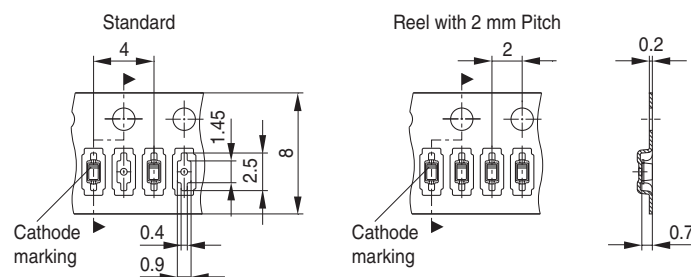

Date Code marking for discrete packages with one digit (SCD80, SC79, SC75<sup>1)</sup>) CES-Code

Month	2003	2004	2005	2006	2007	2008	2009	2010	2011	2012	2013	2014
01	a	p	A	P	a	p	A	P	a	p	A	P
02	b	q	B	Q	b	q	B	Q	b	q	B	Q
03	c	r	C	R	c	r	C	R	c	r	C	R
04	d	s	D	S	d	s	D	S	d	s	D	S
05	e	t	E	T	e	t	E	T	e	t	E	T
06	f	u	F	U	f	u	F	U	f	u	F	U
07	g	v	G	V	g	v	G	V	g	v	G	V
08	h	x	H	X	h	x	H	X	h	x	H	X
09	j	y	J	Y	j	y	J	Y	j	y	J	Y
10	k	z	K	Z	k	z	K	Z	k	z	K	Z
11	l	2	L	4	l	2	L	4	l	2	L	4
12	n	3	N	5	n	3	N	5	n	3	N	5

1) New Marking Layout for SC75, implemented at October 2005.

Package Outline

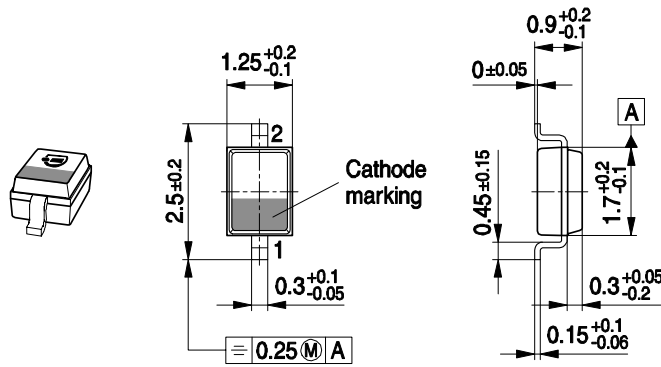

Foot Print

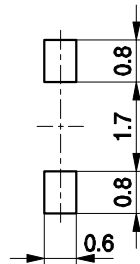

Marking Layout (Example)

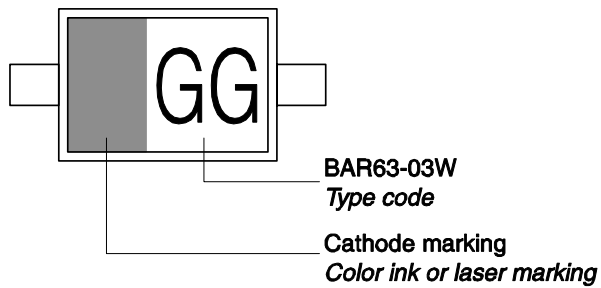

Standard Packing

Reel ø180 mm = 3.000 Pieces/Reel  
 Reel ø330 mm = 10.000 Pieces/Reel

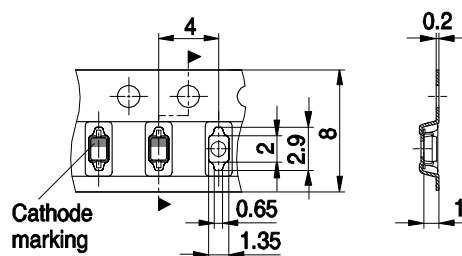

Package Outline

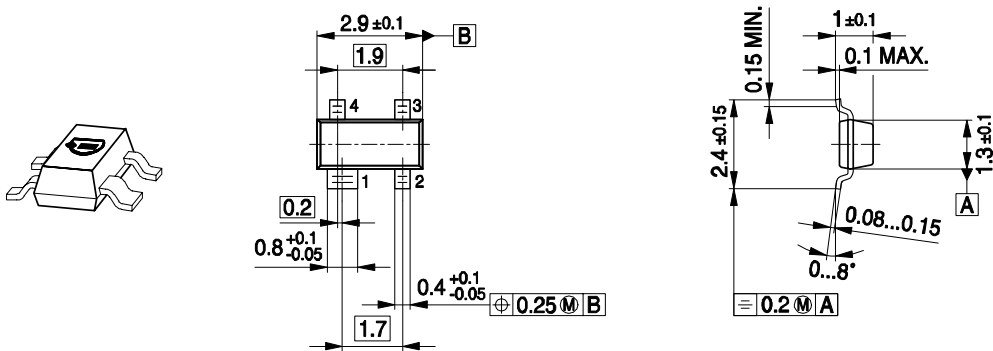

Note: Mold flash, protrusions or gate burrs of 0,2 mm max. per side are not included

SOT143-PO V09

Foot Print

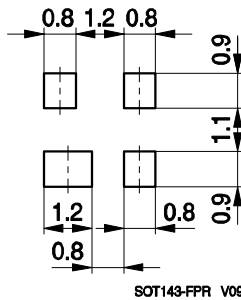

SOT143-FPR V09

Marking Layout (Example)

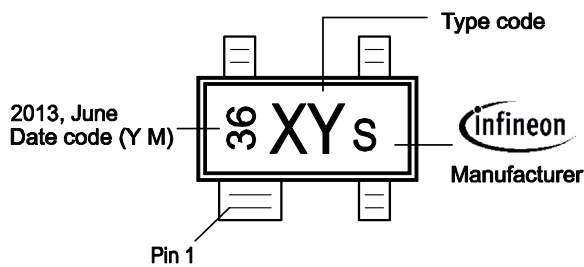

Standard Packing

Reel ø180 mm = 3.000 Pieces/Reel  
 Reel ø330 mm = 10.000 Pieces/Reel

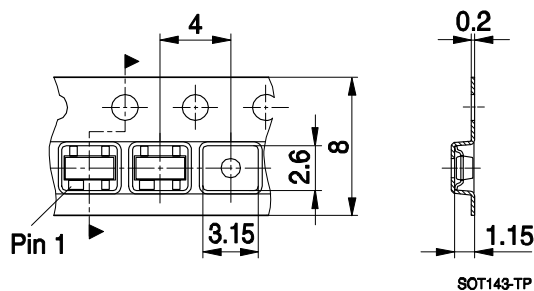

SOT143-TP

Package Outline

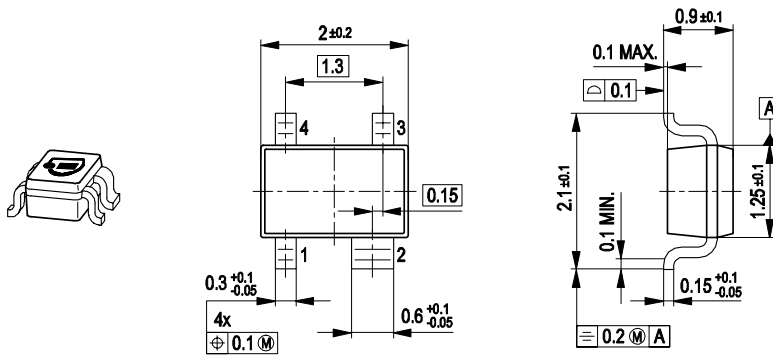

Foot Print

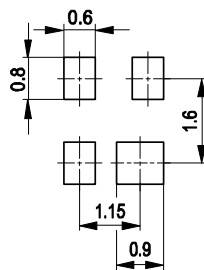

Marking Layout (Example)

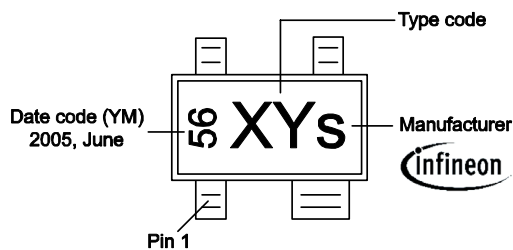

Standard Packing

Reel ø180 mm = 3.000 Pieces/Reel  
 Reel ø330 mm = 10.000 Pieces/Reel

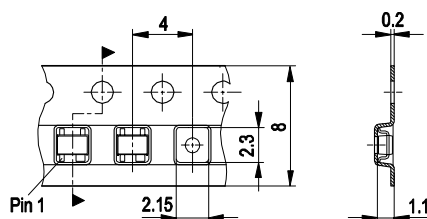

### Package Outline

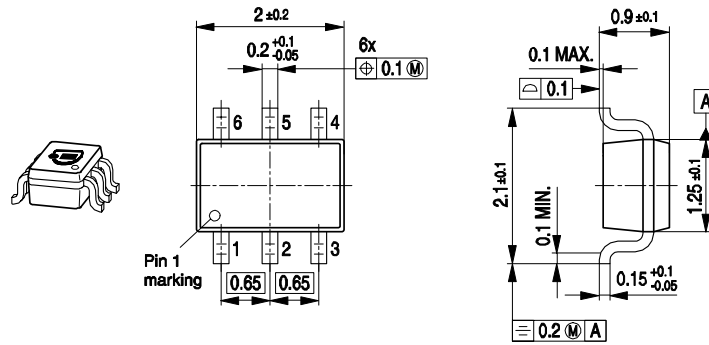

### Foot Print

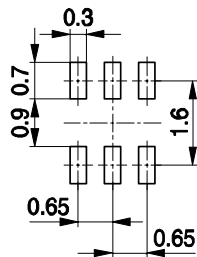

### Marking Layout (Example)

Small variations in positioning of Date code, Type code and Manufacture are possible.

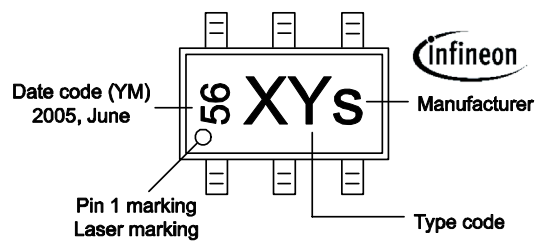

### Standard Packing

Reel  $\varnothing$ 180 mm = 3.000 Pieces/Reel  
 Reel  $\varnothing$ 330 mm = 10.000 Pieces/Reel

For symmetric types no defined Pin 1 orientation in reel.

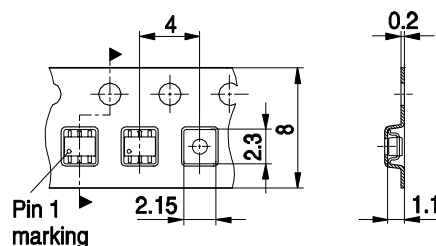

### Package Outline

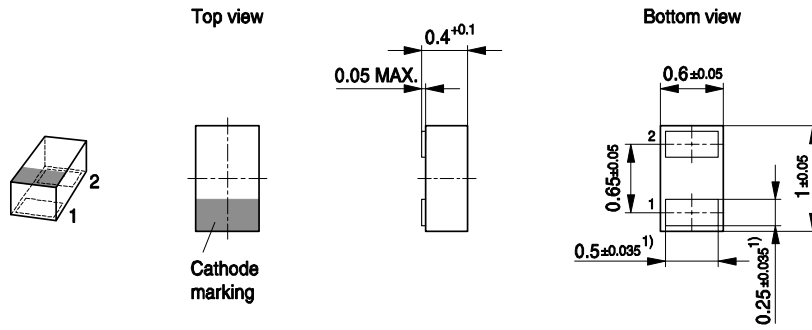

1) Dimension applies to plated terminal

### Foot Print

For board assembly information please refer to Infineon website "Packages"

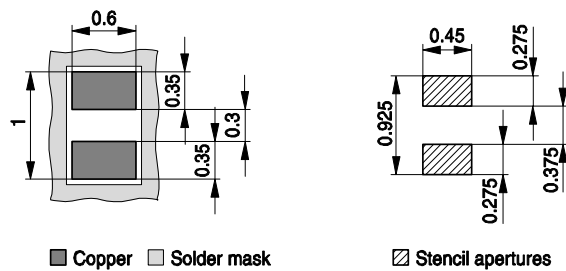

■ Copper □ Solder mask

▨ Stencil apertures

### Marking Layout (Example)

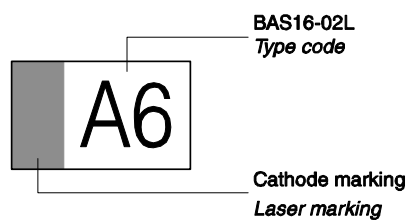

### Standard Packing

Reel  $\varnothing$ 180 mm = 15.000 Pieces/Reel  
 Reel  $\varnothing$ 330 mm = 50.000 Pieces/Reel (optional)

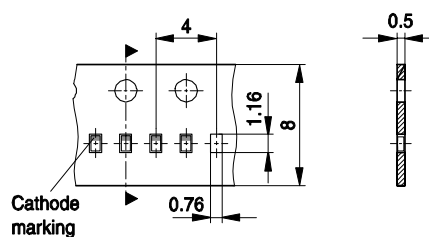



### Package Outline

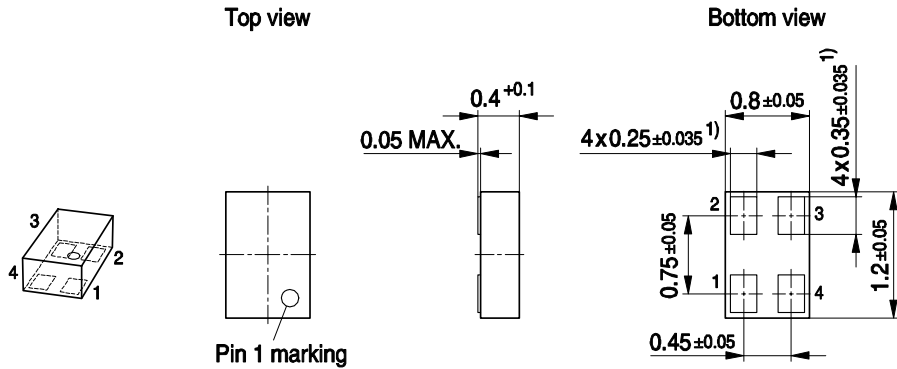

1) Dimension applies to plated terminal

### Foot Print

For board assembly information please refer to Infineon website "Packages"

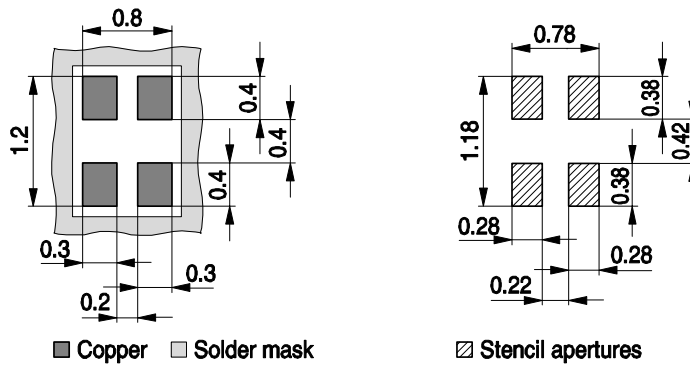

### Marking Layout (Example)

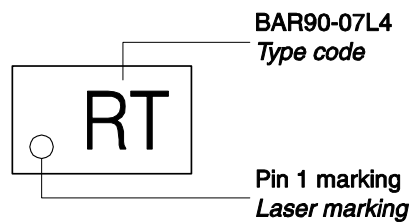

### Standard Packing

Reel ø180 mm = 15.000 Pieces/Reel

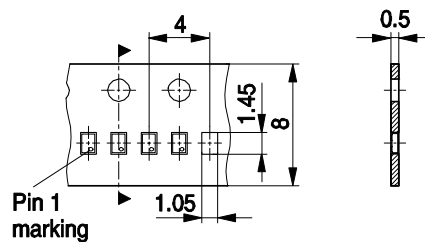

### Package Outline

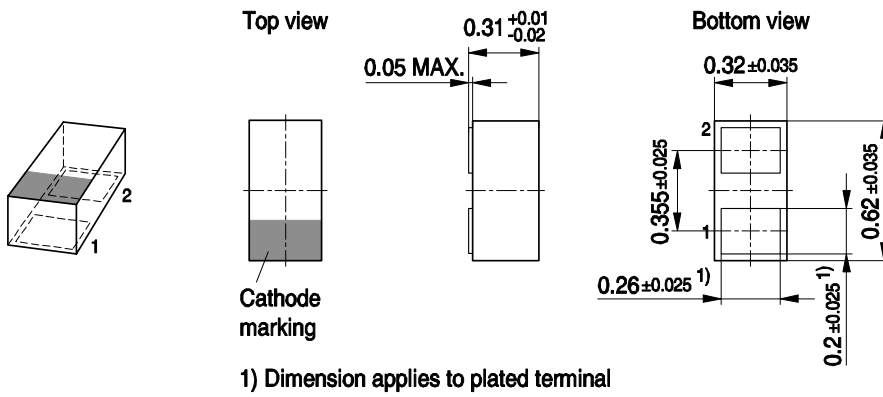

### Foot Print

For board assembly information please refer to Infineon website "Packages"

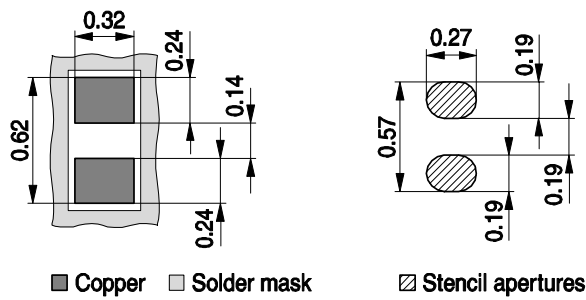

### Marking Layout (Example)

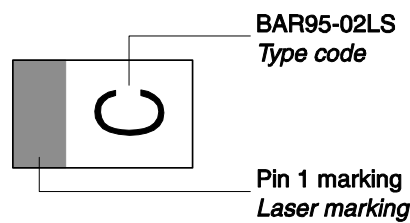

### Standard Packing

Reel ø180 mm = 15.000 Pieces/Reel

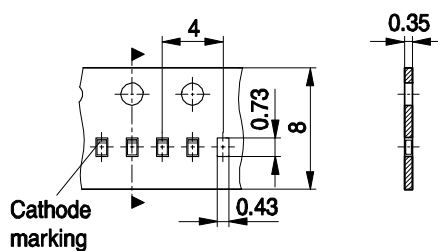

**Edition 2009-11-16**

**Published by  
Infineon Technologies AG  
81726 Munich, Germany**

**© 2009 Infineon Technologies AG  
All Rights Reserved.**

### **Legal Disclaimer**

The information given in this document shall in no event be regarded as a guarantee of conditions or characteristics. With respect to any examples or hints given herein, any typical values stated herein and/or any information regarding the application of the device, Infineon Technologies hereby disclaims any and all warranties and liabilities of any kind, including without limitation, warranties of non-infringement of intellectual property rights of any third party.

### **Information**

For further information on technology, delivery terms and conditions and prices, please contact the nearest Infineon Technologies Office ([www.infineon.com](http://www.infineon.com)).

### **Warnings**

Due to technical requirements, components may contain dangerous substances. For information on the types in question, please contact the nearest Infineon Technologies Office.

Infineon Technologies components may be used in life-support devices or systems only with the express written approval of Infineon Technologies, if a failure of such components can reasonably be expected to cause the failure of that life-support device or system or to affect the safety or effectiveness of that device or system. Life support devices or systems are intended to be implanted in the human body or to support and/or maintain and sustain and/or protect human life. If they fail, it is reasonable to assume that the health of the user or other persons may be endangered.

## X-ON Electronics

Largest Supplier of Electrical and Electronic Components

*Click to view similar products for [Schottky Diodes & Rectifiers](#) category:*

*Click to view products by [Infineon](#) manufacturer:*

Other Similar products are found below :

[MA4E2039](#) [D1FH3-5063](#) [MBR0530L-TP](#) [MBR10100CT-BP](#) [MBR1545CT](#) [MMBD301M3T5G](#) [RB160M-50TR](#) [RB551V-30](#)

[BAS16E6433HTMA1](#) [BAT 54-02LRH E6327](#) [NSR05F40QNXT5G](#) [NTE555](#) [JANS1N6640](#) [SB07-03C-TB-H](#) [SB1003M3-TL-W](#) [SK310-T](#)

[SK32A-LTP](#) [SK34B-TP](#) [SS3003CH-TL-E](#) [GA01SHT18](#) [CRS10I30A\(TE85L,QM](#) [MA4E2501L-1290](#) [MBRB30H30CT-1G](#) [SB007-03C-TB-](#)

[E](#) [SK32A-TP](#) [SK33B-TP](#) [SK38B-TP](#) [NRVBM120LT1G](#) [NTE505](#) [NTSB30U100CT-1G](#) [SS15E-TP](#) [VS-6CWQ10FNHM3](#) [ACDBA1100LR-](#)

[HF](#) [ACDBA1200-HF](#) [ACDBA140-HF](#) [ACDBA2100-HF](#) [ACDBA3100-HF](#) [CDBQC0530L-HF](#) [CDBQC0240LR-HF](#) [ACDBA260LR-HF](#)

[ACDBA1100-HF](#) [SK310B-TP](#) [MA4E2502L-1246](#) [MA4E2502H-1246](#) [NRVBM120ET1G](#) [NSR01L30MXT5G](#) [NTE573](#) [NTE6081](#) [SB560](#)

[PMAD1108-LF](#)