

LED Driver IC BCR450

Power Management and
Multimarket



Never stop thinking

Edition 2013-02-21

**Published by Infineon Technologies AG,
81726 München, Germany**

**© Infineon Technologies AG 2013.
All Rights Reserved.**

Attention please!

The information herein is given to describe certain components and shall not be considered as a guarantee of characteristics.

Terms of delivery and rights to technical change reserved.

We hereby disclaim any and all warranties, including but not limited to warranties of non-infringement, regarding circuits, descriptions and charts stated herein.

Information

For further information on technology, delivery terms and conditions and prices please contact your nearest Infineon Technologies Office (www.infineon.com).

Warnings

Due to technical requirements components may contain dangerous substances. For information on the types in question please contact your nearest Infineon Technologies Office.

Infineon Technologies Components may only be used in life-support devices or systems with the express written approval of Infineon Technologies, if a failure of such components can reasonably be expected to cause the failure of that life-support device or system, or to affect the safety or effectiveness of that device or system. Life support devices or systems are intended to be implanted in the human body, or to support and/or maintain and sustain and/or protect human life. If they fail, it is reasonable to assume that the health of the user or other persons may be endangered.

1 BCR450 Power LED Driver IC

Features

- Low voltage drop across sense resistor, 0.15 V typical
- High output current precision
- Operating voltage from 8 to 27 V
- Over voltage protection
- Overtemperature current foldback and Thermal shut down function
- Adjustable Constant LED Current up to 85 mA in stand alone operation
- Precise Internal bandgap enables High output current accuracy
- Up to 2.5 A LED current possible by using external transistor
- EN Input for PWM LED brightness control and On/Off control
- Very Low Standby Current
- Minimum number of external components required, no inductors
- Very small SC-74 package: 2.9 mm x 2.5 mm x 1.1 mm

Benefits

- High level of colour control due to high output current precision
- Small space requirement
- No electro- magnetic interference
- Active thermal monitoring of chip and LED temperature with current fold- back to avoid thermal overstress
- Low cost device
- Scalable output stage optimizing cost and space

Typical Applications

- General lighting e.g. retrofits
- Architectural lighting, Medical and Dental lighting
- Transportation like train and aircraft lighting
- Strobe lighting
- Universal constant current source
- Signal and marker lights for orientation or navigation
- LED controller for industrial applications, not qualified to AECQ-100

2 Description

The BCR450 is a LED driver IC optimized for usage with an external power transistor for driving LEDs above 100 mA. For currents up to 85 mA the BCR450 can be used in stand alone operation. The output current level can be adjusted with an external sense resistor.

The IC can be switched on and off by an external signal, which is also suitable to regulate brightness of the LEDs by PWM dimming.

The precise internal bandgap stabilizes the circuit and provides stable current conditions over temperature range. Additional features are included to protect the LEDs from overload, short circuit events as well as from over voltage. The LEDs can be also protected against thermal overload by thermally coupling the LEDs to the BCR450.

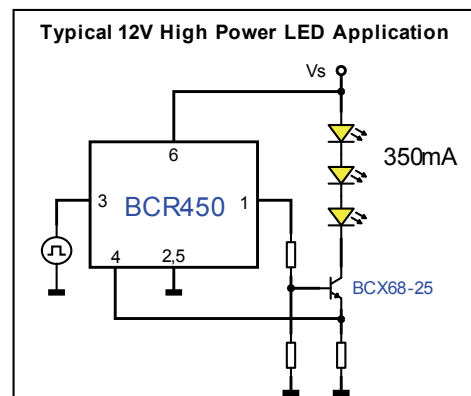
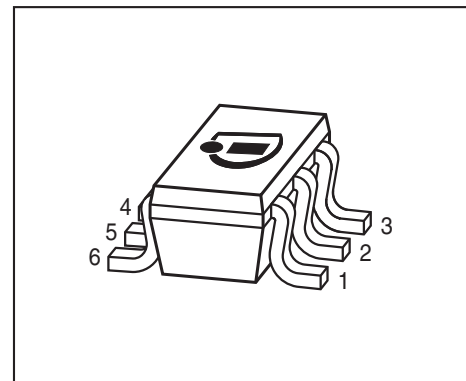

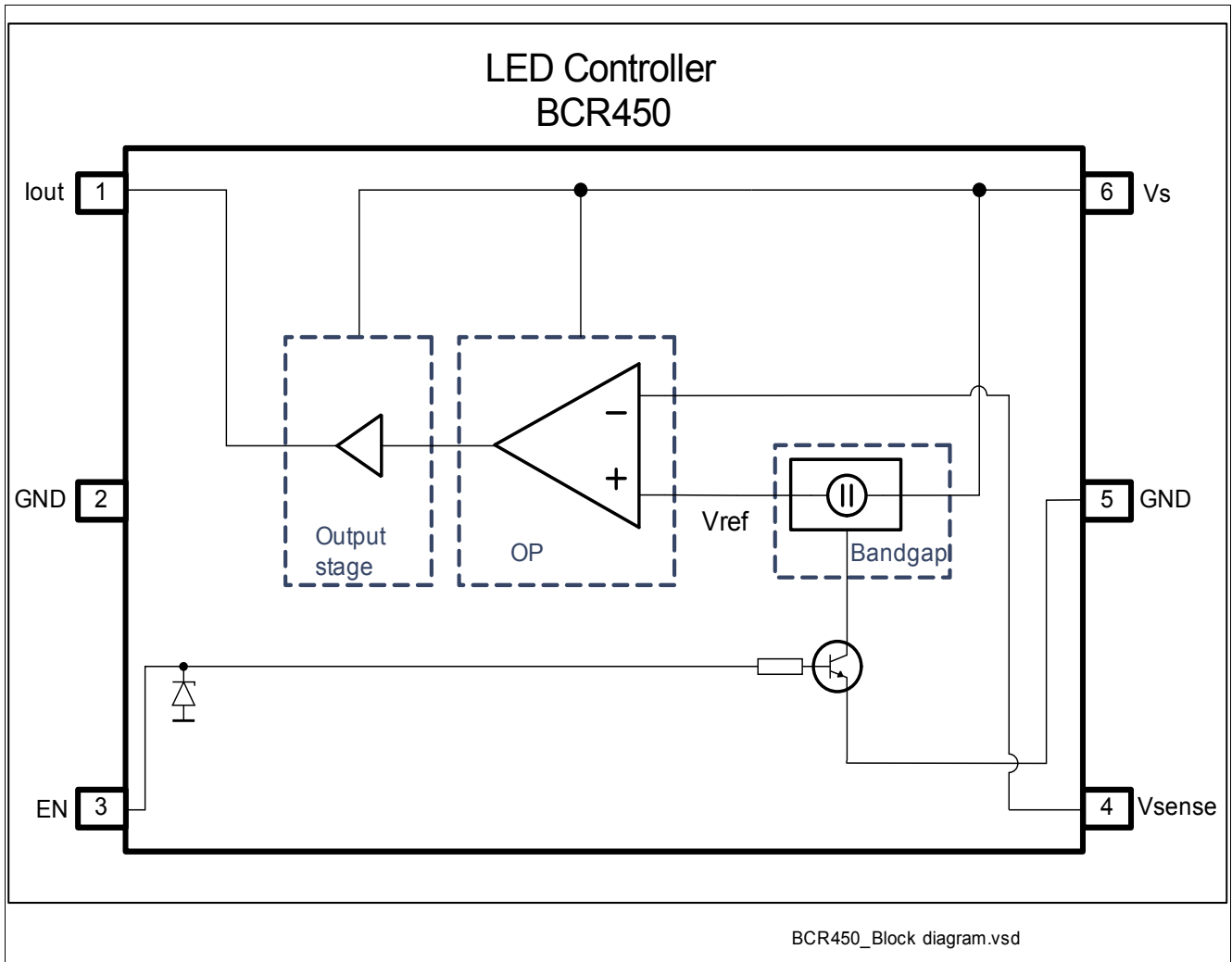

Figure 1 Block diagram

Pin Definition

Table 1 Pin definition and function

Pin number	Pin Symbol	Function
1	I_{out}	Controlled output current to drive LEDs
2	GND	IC ground
3	EN	Power On control voltage pin (<i>PWM input</i>)
4	V_{sense}	Sense control voltage pin for internal feedback mechanism
5	GND	IC ground
6	V_s	Supply voltage

Table 2 Marking

Type	Marking	Package
BCR450	50s	SC74

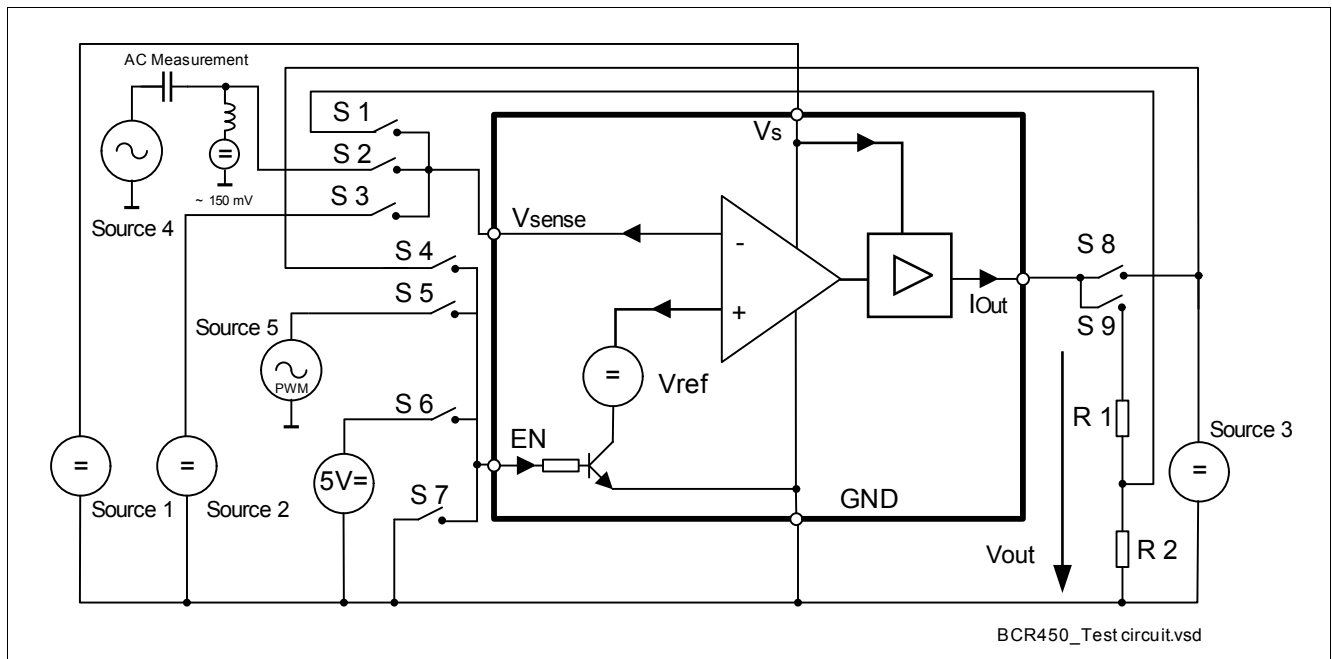
Figure 2 Electrical test circuit
Thermal resistance
Table 3 Thermal resistance

Parameter	Symbol	Value	Unit
Junction - solder point	R_{thJS}	75	K/W

Absolute Maximum Ratings
Table 4 Absolute Maximum ratings

Parameter	Symbol	Limit Value	Unit
Supply voltage	V_s	40	V
Sense Voltage	V_{sense}	200	mV
Output current	I_{out}	100	mA
Total Power Dissipation; $T_s = 112.5^\circ\text{C}$	P_{tot}	500	mW
Junction temperature	T_J	150	$^\circ\text{C}$
Storage temperature range	T_{STG}	-65... 150	$^\circ\text{C}$
ESD capability Human Body Model ¹⁾	V_{ESD_HBM}	2000	V

1) For ESD testing, the chip was mounted in a SC74 package on an application board, where GND is electrically connected to the chip GND

3 Electrical Characteristics

3.1 DC Characteristics

$8\text{ V} < V_s < 27\text{ V}$; $-40\text{ }^\circ\text{C} < T_J < 150\text{ }^\circ\text{C}$, all voltages with respect to ground; current directions as given in [Figure 2](#); unless otherwise specified

All parameters are tested at $25\text{ }^\circ\text{C}$, unless otherwise specified

Table 5 DC Characteristics

Parameter	Symbol	Values			Unit	Note / Test Condition
		Min.	Typ.	Max.		
Overall current consumption	$I_{S_{\text{short}}}$	70	90		mA	I_s short; $V_s = 8..27\text{ V}$ $V_{\text{sense}} = 20\text{ mV}$
Overall current consumption	$I_{S_{\text{short}}}$			600	μA	I_s short; $V_s = 42\text{ V}$ $V_{\text{sense}} = 20\text{ mV}$
Overall standby current consumption	$I_{S_{\text{standby}}}$			200	nA	EN = 0 V; $V_s = 8..27\text{ V}$ $V_{\text{sense}} = 20\text{ mV}$
Current of enable input	I_{EN}	20	40	70	μA	$V_{\text{sense}} = 0..200\text{ mV}$
Current of driver output	I_{outhigh}	70	90		mA	$V_{\text{sense}} = 20\text{ mV}$; $V_s = 8\text{ V}$
Current of driver output	I_{outlow}			100	nA	$V_{\text{sense}} = 200\text{ mV}$; $V_s = 8\text{ V}$
Current of Sense input	I_{sense}			200	nA	$V_{\text{sense}} = 20..200\text{ mV}$
Voltage of Driver output	V_{out}		6		V	$I_{\text{out}} = 15\text{ mA}$; S1, S6, S8, S9 = on; R1 = 390 Ω ; R2 = 10 Ω ; see Figure 2
Voltage of Sense input	V_{sense}	135	150	165	mV	$I_{\text{out}} = 15\text{ mA}$; $V_s = 8..27\text{ V}$ S3, S6, S8 = on; R1 = 390 Ω ; R2 = 10 Ω $T_J = 115\text{ }^\circ\text{C}$ see Figure 2
Enable voltage range	U_{Pon}	-0.3		5 ¹⁾	V	
Control voltage for power on	U_{On}	0.6	0.85	5	V	
Control voltage for power off	U_{Off}	-0.3		0.35	V	
Over voltage Protection	$V_{s, \text{OV}}$	27			V	$I_{\text{out}} \rightarrow 0\text{ A}$
Delta sense voltage	ΔV_{sense}	2	10	50	mV	$I_{\text{out}}: 0 \rightarrow 50\text{ mA}$
Drop Voltage	$V_s - V_{\text{out}}$		1.2		V	$I_{\text{out}} < 40\text{ mA}$
Temperature shut down	T_{SD}	130	150	170	$^\circ\text{C}$	$I_{\text{out}} \rightarrow 0\text{ A}$; refer to T_J

1) ESD protection diode of pin 3 (EN) will breakdown above 5 V input voltage to GND

3.2 Digital Signals

All parameters are tested at 25 °C, unless otherwise specified

Table 6 Digital Control Parameter (EN)

Parameter	Symbol	Values			Unit	Note / Test Condition
		Min.	Typ.	Max.		
PWM signal frequency	f_{PWM}			1000	Hz	$t_{\text{duty cycle}} = 1\%$; signal level reaches 100% in on and off mode
PWM Duty cycle	$t_{\text{duty PWM}}$	5			%	$F = 5 \text{ kHz}$; signal level reaches 100% in on and off mode
PWM voltage	U_{PWM}			5	V	
EN input capacitance to GND	C_{EN}		130		pF	EN = 0 V

3.3 Transient Parameters

$8 \text{ V} < V_{\text{S}} < 27 \text{ V}$; $-40 \text{ }^{\circ}\text{C} < T_{\text{J}} < 150 \text{ }^{\circ}\text{C}$, all voltages with respect to ground; current directions as given in [Figure 2](#); unless otherwise specified

All parameters are tested at 25 °C, unless otherwise specified

Table 7 Digital Control Parameter (EN)

Parameter	Symbol	Values			Unit	Note / Test Condition
		Min.	Typ.	Max.		
Response Time	T_{ON}			10	μs	EN: 0 -> 5 V @ $t_{\text{rise}} < 20 \text{ ns}$ $t_{\text{risetime}} @ (10\text{...}90\%) * V_{\text{sense}}$ ($I_{\text{out}} \sim 15 \text{ mA}$); $R_{\text{sense}} = 10 \text{ } \Omega$
	T_{OFF}			70	μs	EN: 5 V -> 0 @ $t_{\text{fall}} < 20 \text{ ns}$ $t_{\text{falltime}} @ (90\text{...}10\%) * V_{\text{sense}}$ ($I_{\text{out}} \sim 15 \text{ mA}$); $R_{\text{sense}} = 10 \text{ } \Omega$

4 Measured Parameters

BCR450 IC has been measured in test bench with undefined high thermal resistance
This is valid for all diagramed DC- and AC- Parameters

4.1 DC- Parameter

$$V_{out} = 1.0 \text{ V, EN} = 2.4 \text{ V}$$

I_S vers Temperature (V_S); $V_{sense} = 20 \text{ mV}$

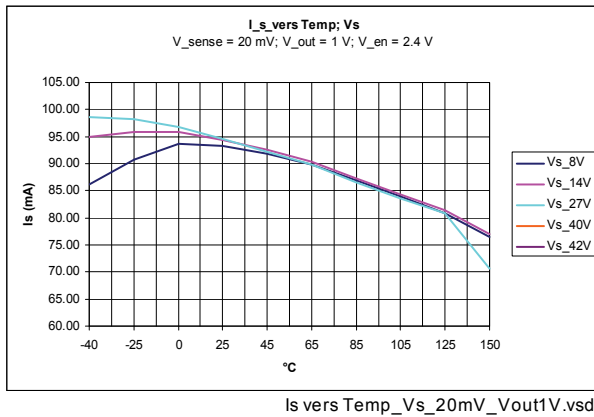

I_S vers V_S (Temperature); $V_{sense} = 20 \text{ mV}$

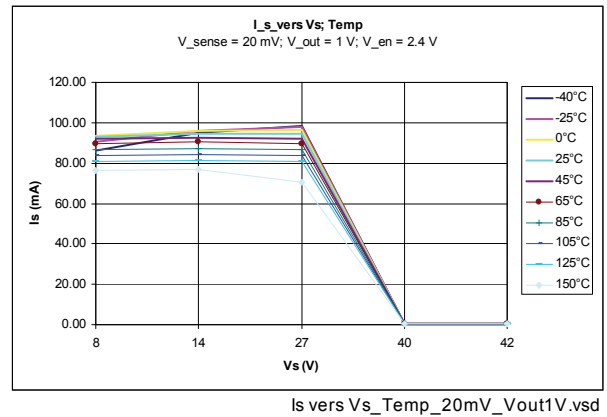

I_{en} vers Temperature (V_S); $V_{sense} = 20 \text{ mV}$

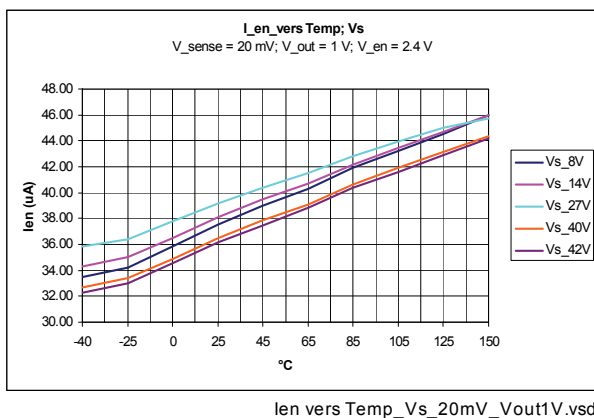

I_{en} vers V_S (Temperature); $V_{sense} = 20 \text{ mV}$

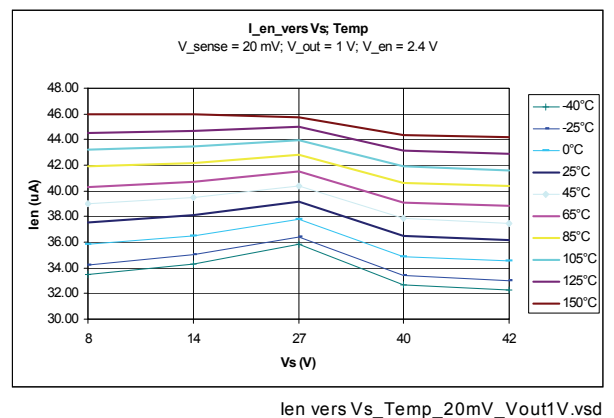

Measured Parameters

I_{sense} vers Temperature (V_s); $V_{sense} = 20$ mV

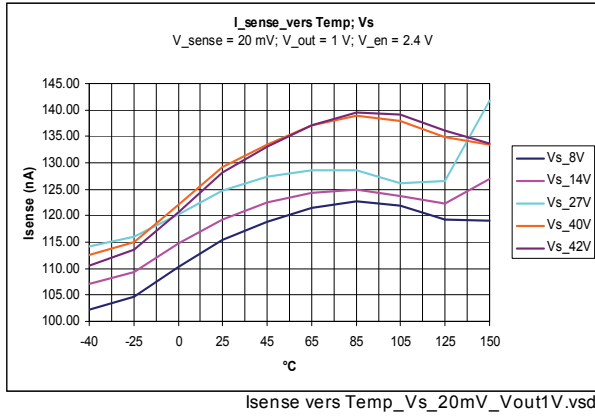

I_{sense} vers V_s (Temperature); $V_{sense} = 20$ mV

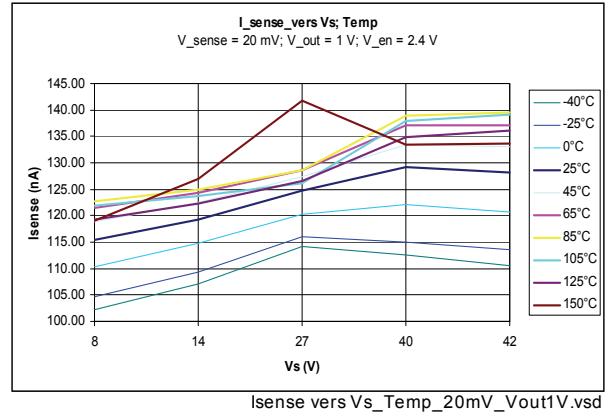

I_{out} vers Temperature (V_s); $V_{sense} = 20$ mV

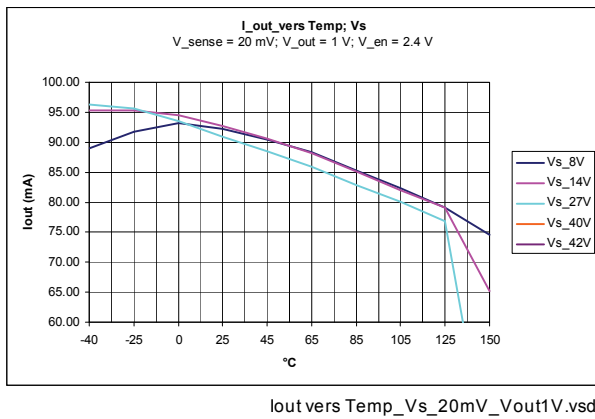

I_{out} vers V_s (Temperature); $V_{sense} = 20$ mV

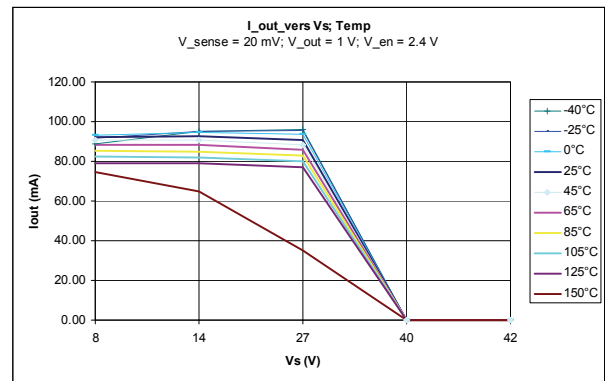

$V_s = 14$ V, $V_{out} = 1$ V; $EN = 2.4$ V

I_{out} vers Temperature (V_{sense})

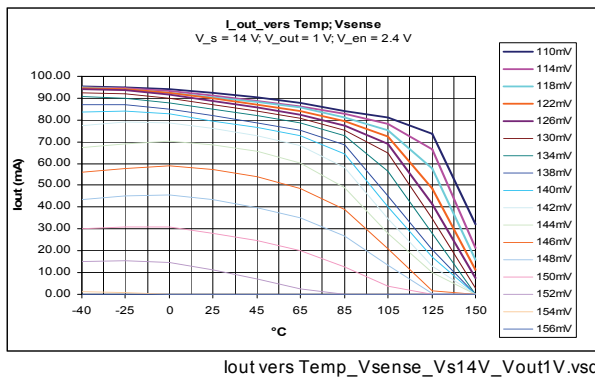

I_{out} vers V_{sense} (Temperature)

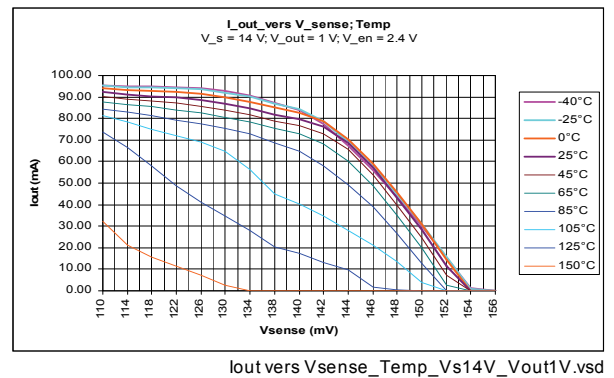

$V_s = 14\text{ V}$, $V_{out} = 6\text{ V}$; $EN = 20\text{ mV}$

I_{out} vers EN (Temperature)

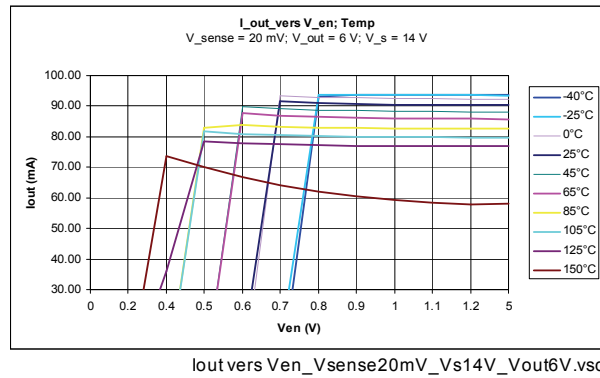

$V_s = 14\text{ V}$, $V_{sense} = 20\text{ mV}$; $EN = 2.4\text{ V}$

I_{out} vers Temperature (V_{out})

I_{out} vers V_{out} (Temperature)

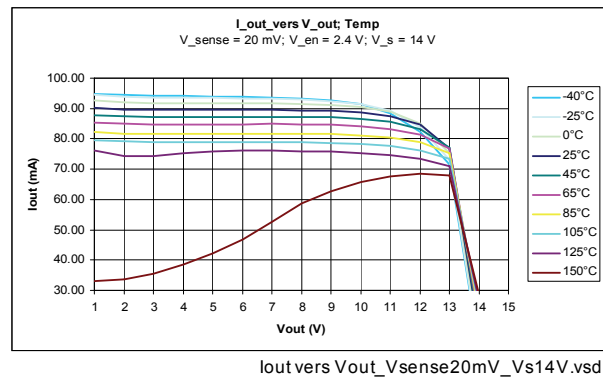
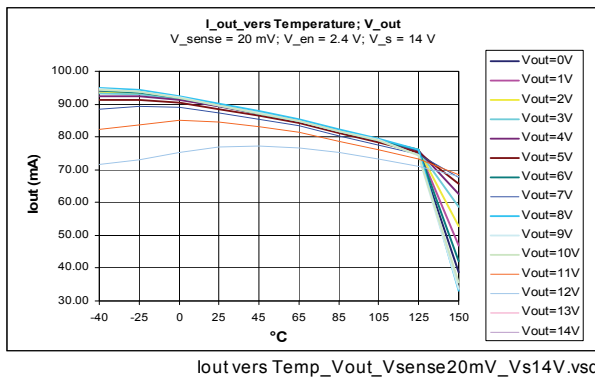

$V_{out} = 1\text{ V}$, $V_{sense} = 20\text{ mV}$; $EN = 2.4\text{ V}$

I_s vers V_s (Temperature)

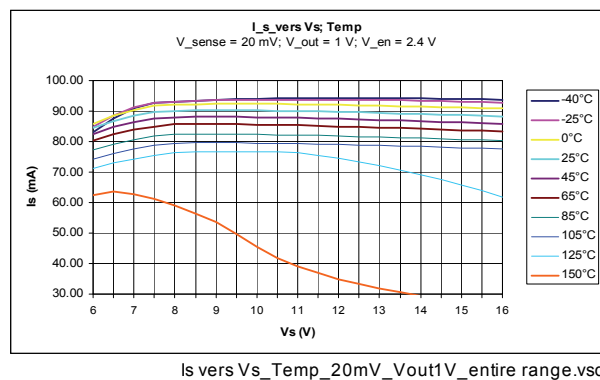

$V_{out} = 6\text{ V}$, $V_{sense} = 20\text{ mV}$; $EN = 2.4\text{ V}$

I_s vers V_S (Temperature)

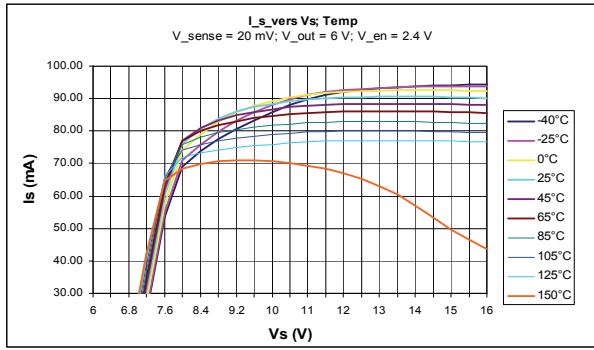

Is vers Vs_Temp_20mV_Vout6V.vsd

I_s vers V_S (Temperature)

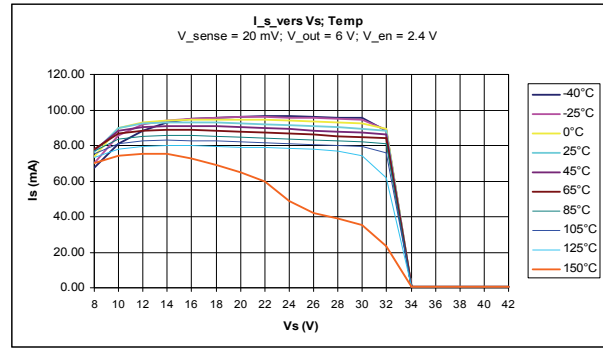

Is vers Vs_Temp_20mV_Vout6V_entire range.vsd

$I_{s\text{ short}} \rightarrow V_{out} = 0\text{ V}$, $V_{sense} = 0\text{ mV}$; $EN = 2.4\text{ V}$

I_s vers V_S (Temperature)

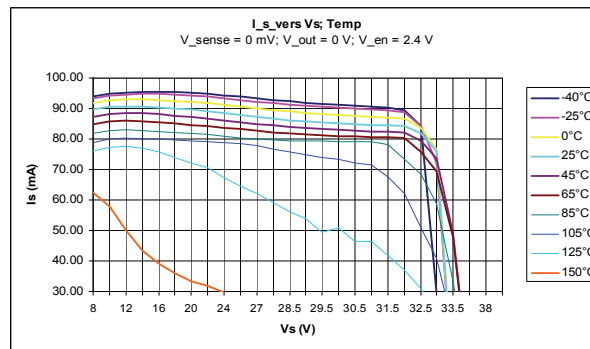

Is vers Vs_Temp_0mV_Vout0V.vsd

$I_{s\text{ standby}} \rightarrow V_{out} = 0\text{ V}$, $V_{sense} = 0\text{ mV}$; $EN = 0\text{ V}$

I_s vers V_S (Temperature)

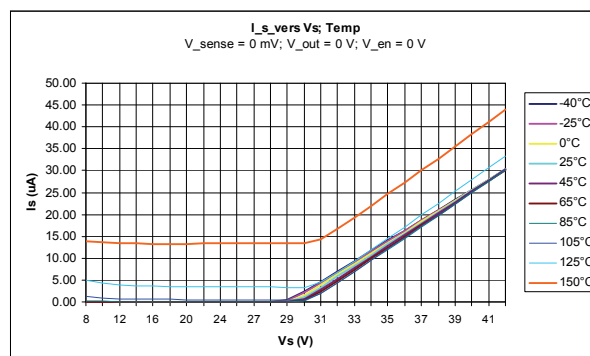

Is vers Vs_Temp_0mV_Vout0V_EN0V.vsd

$V_{out} = 6\text{ V}$, $I_{out} = 15\text{ mA}$; $EN = 2.4\text{ V}$

V_{sense} vers V_S (Temperature)

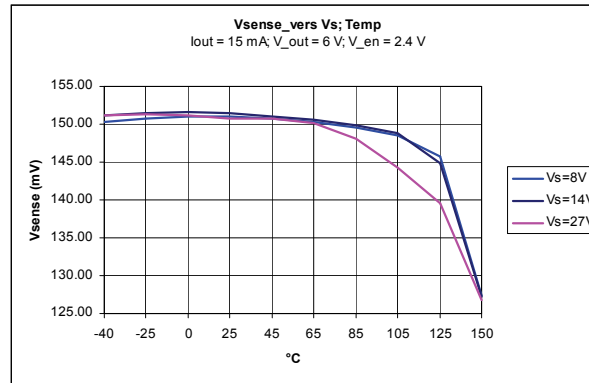

Vsense vers Vs_Temp_Iout15mA_Vout6V.vsd

$V_S = 12\text{ V}$, $I_{out} = 350\text{ mA}$, Booster Application, see Figure 3

I_{out} vers T_{solder}

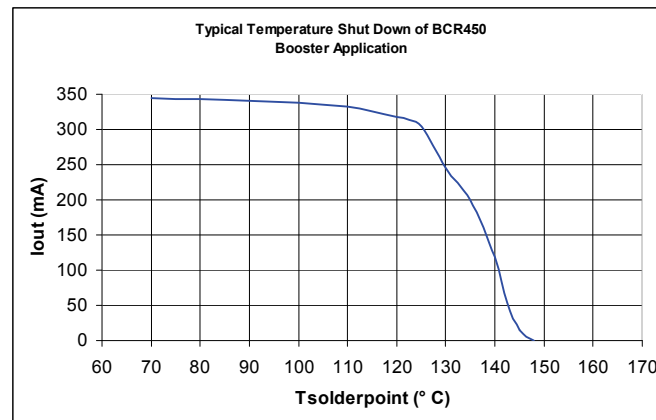

TSD.vsd

EN = 2.4 V

V_{drop} vers I_{out}

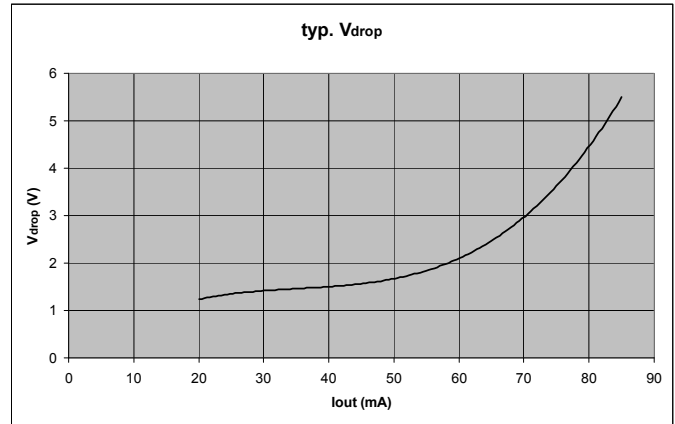
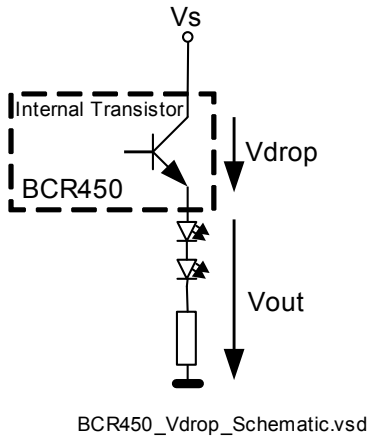

4.2 AC- Parameter

Response Time

T_{on} & T_{off} ; $V_s = 12\text{ V}$; $f_{Pulse} = 1\text{ kHz}$; $t_{duty} = 50\%$

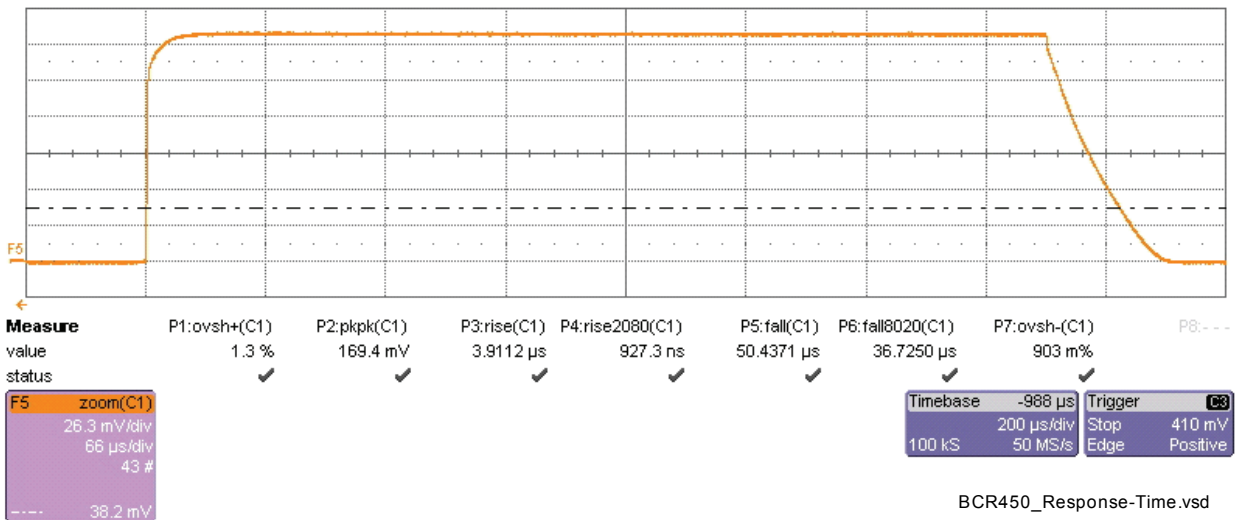

5 Evaluation Board

The evaluation board is designed to test the BCR450 as a stand alone device for lower LED current applications and also with additional external “booster” transistors for high current, high brightness LEDs. Up to three external transistors BCX68 or BC817SU each could be used on the PCB to minimize thermal problems.

3 LEDs in series for high current mode or 3 LEDs for low current applications can be chosen by setting resistors (for further application hints see **AN105**). The particular sense voltage can be derived by jumpers which are provided in the layout for each test case. Additional test circuit is included to measure AC characteristics, and the ENABLE input is designed to connect a PWM signal. The PCB is manufactured in double sided FR4 with substrate thickness of 1.0 mm.

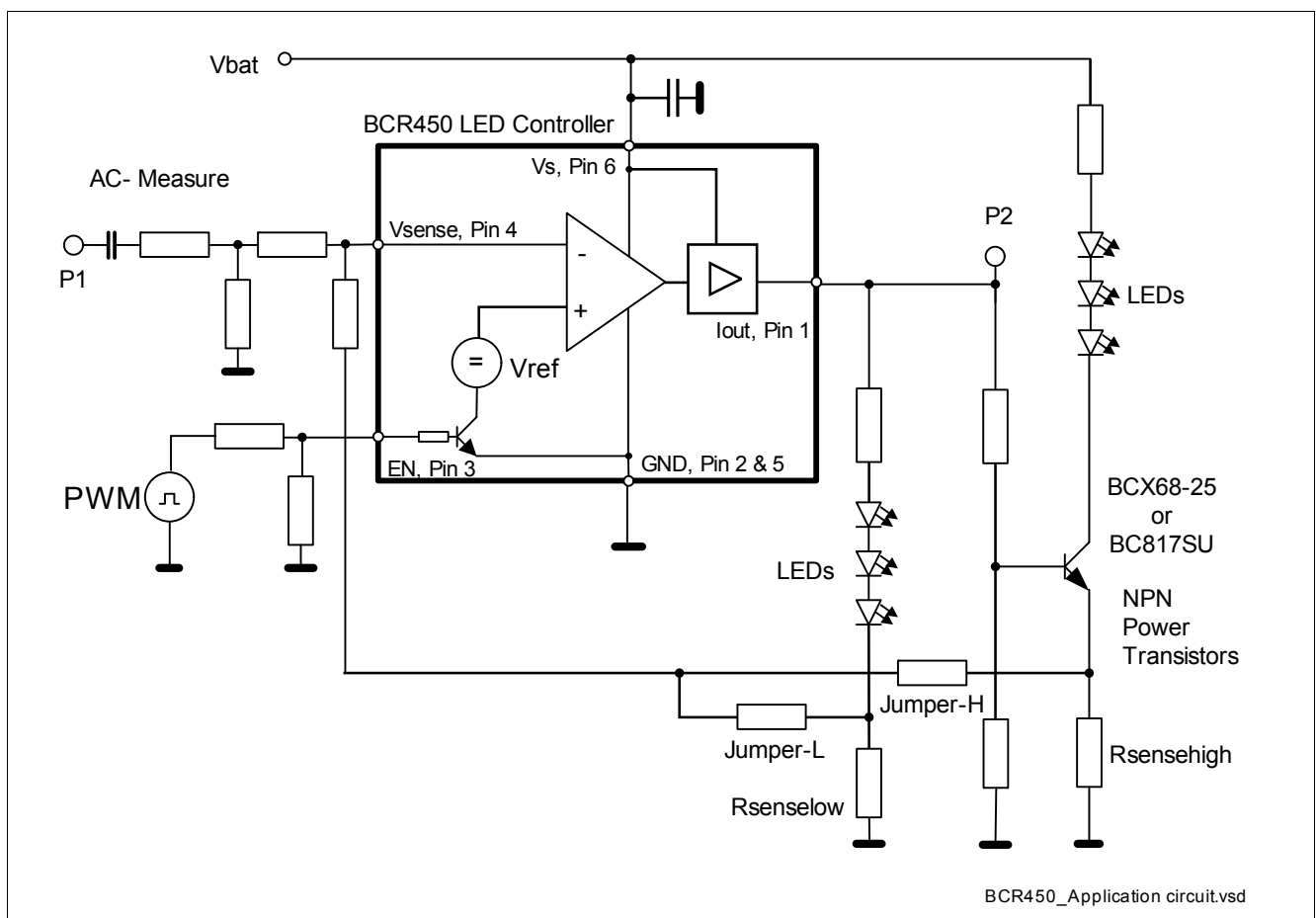

Figure 3 Evaluation board schematic

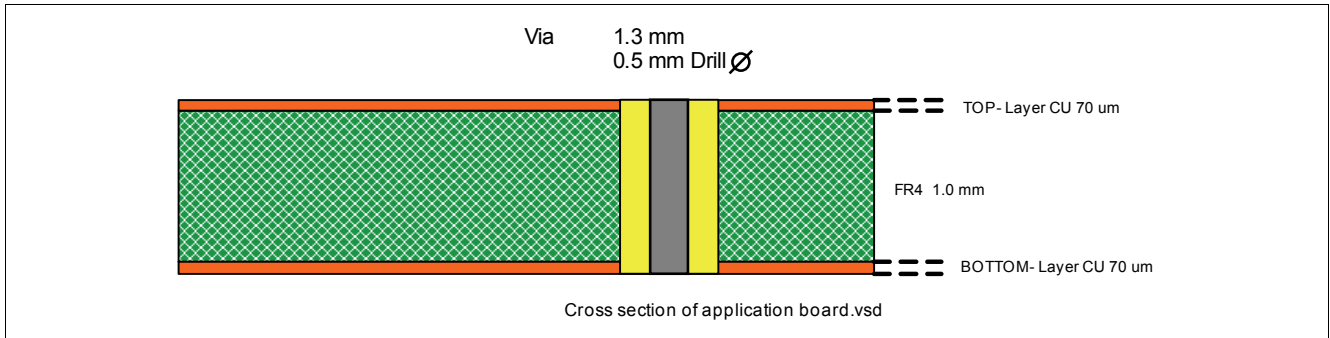

Figure 4 Cross section of evaluation board

6 Package Information

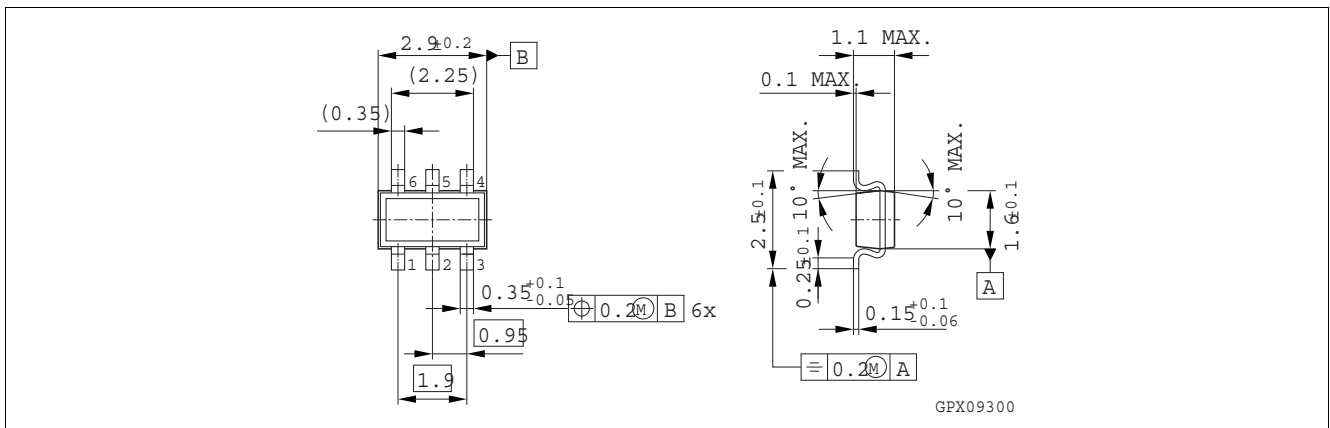

Figure 5 Package outline; SC74 (dimensions in mm)

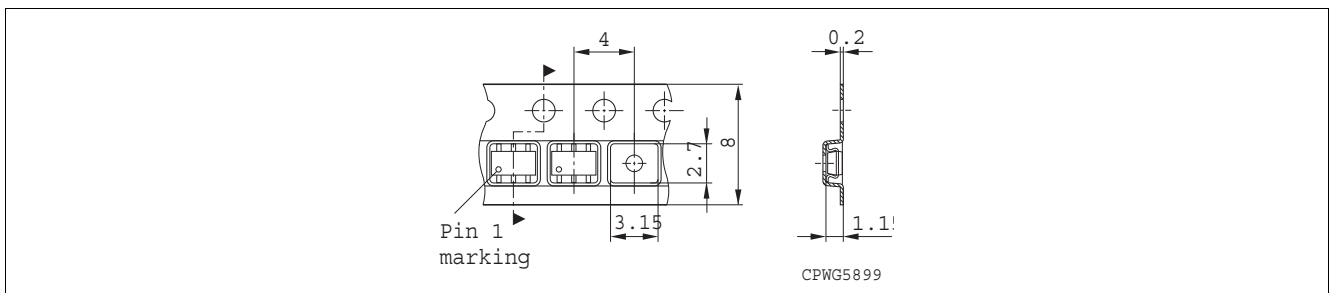

Figure 6 Tape loading (dimensions in mm)

X-ON Electronics

Largest Supplier of Electrical and Electronic Components

Click to view similar products for [LED Lighting Drivers](#) category:

Click to view products by [Infineon](#) manufacturer:

Other Similar products are found below :

[LV5235V-MPB-H](#) [MB39C602PNF-G-JNEFE1](#) [MIC2871YMK-T5](#) [AL1676-10BS7-13](#) [AL1676-20AS7-13](#) [AP5726WUG-7](#) [MX877RTR](#)
[ICL8201](#) [IS31BL3228B-UTLS2-TR](#) [IS31BL3506B-TTLS2-TR](#) [AL3157F-7](#) [AP5725FDCG-7](#) [AP5726FDCG-7](#) [LV52204MTTBG](#)
[AP5725WUG-7](#) [STP4CMPQTR](#) [NCL30086BDR2G](#) [CAT4004BHU2-GT3](#) [LV52207AXA-VH](#) [AP1694AS-13](#) [TLE4242EJ](#) [AS3688](#)
[IS31LT3172-GRLS4-TR](#) [TLD2311EL](#) [KTD2694EDQ-TR](#) [KTZ8864EJAA-TR](#) [IS32LT3174-GRLA3-TR](#) [ZXLD1374QESTTC](#) [MP2488DN-](#)
[LF-Z](#) [NLM0010XTSA1](#) [AL1676-20BS7-13](#) [MPQ7220GF-AEC1-P](#) [MPQ7220GF-AEC1-Z](#) [MPQ4425BGJ-AEC1-Z](#) [IS31FL3737B-QFLS4-](#)
[TR](#) [IS31FL3239-QFLS4-TR](#) [KTD2058EUAC-TR](#) [KTD2037EWE-TR](#) [DIO5662ST6](#) [IS31BL3508A-TTLS2-TR](#) [MAX20052CATC/V+](#)
[MAX25606AUP/V+](#) [BD6586MUV-E2](#) [BD9206EFV-E2](#) [BD9416FS-E2](#) [LYT4227E](#) [LYT6079C-TL](#) [MP3394SGF-P](#) [MP4689AGN-P](#)
[MPQ4425AGQB-AEC1-Z](#)