

BFP640ESD

Surface mount robust silicon NPN RF bipolar transistor



Order now



Technical documents



Simulation



Support

Product description

The BFP640ESD is a RF bipolar transistor based on SiGe:C technology that is part of Infineon's established sixth generation transistor family. Its ESD structure, high RF gain and low noise figure characteristics make the device suitable for a wide range of wireless applications. It remains cost competitive without compromising on ease of use.



Feature list

- Minimum noise figure $NF_{min} = 0.8$ dB at 3.5 GHz, 3 V, 6 mA
- High gain $G_{ma} = 19$ dB at 3.5 GHz, 3 V, 30 mA
- $OIP_3 = 26.5$ dBm at 3.5 GHz, 3 V, 30 mA
- High ESD robustness, typical 2 kV (HBM)

Product validation

Qualified for industrial applications according to the relevant tests of JEDEC47/20/22.

Potential applications

- Low noise amplifiers (LNAs) in GNSS receivers
- LNAs in satellite radio (SDARs, DAB) receivers
- LNAs in multimedia applications such as CATV and FM radio

Device information

Table 1 Part information

Product name / Ordering code	Package	Pin configuration				Marking	Pieces / Reel
BFP640ESD / BFP640ESDH6327XTSA1	SOT343	1 = B	2 = E	3 = C	4 = E	T4s	3000

Attention: *ESD (Electrostatic discharge) sensitive device, observe handling precautions*

Table of contents

Table of contents

	Product description	1
	Feature list	1
	Product validation	1
	Potential applications	1
	Device information	1
	Table of contents	2
1	Absolute maximum ratings	3
2	Thermal characteristics	4
3	Electrical characteristics	5
3.1	DC characteristics	5
3.2	General AC characteristics	5
3.3	Frequency dependent AC characteristics	6
3.4	Characteristic DC diagrams	10
3.5	Characteristic AC diagrams	13
4	Package information SOT343	19
	Revision history	20
	Disclaimer	21

Absolute maximum ratings

1 Absolute maximum ratings

Table 2 Absolute maximum ratings at $T_A = 25\text{ °C}$ (unless otherwise specified)

Parameter	Symbol	Values		Unit	Note or test condition
		Min.	Max.		
Collector emitter voltage	V_{CEO}	-	4.1	V	Open base
			3.6		$T_A = -55\text{ °C}$, open base
Collector emitter voltage ¹⁾	V_{CES}		4.1		E-B short circuited
			3.6		$T_A = -55\text{ °C}$, E-B short circuited
Collector base voltage ²⁾	V_{CBO}		4.8		Open emitter
			4.3		$T_A = -55\text{ °C}$, open emitter
Base current	I_B	-10	6	mA	-
Collector current	I_C	-	50		
RF input power	P_{RFIn}		21	dBm	
ESD stress pulse	V_{ESD}	-2	2	kV	HBM, all pins, acc. to JESD22-A114
Total power dissipation ³⁾	P_{tot}	-	200	mW	$T_S \leq 88\text{ °C}$
Junction temperature	T_J		150	°C	-
Storage temperature	T_{Stg}	-55			

Attention: *Stresses above the max. values listed here may cause permanent damage to the device. Exposure to absolute maximum rating conditions for extended periods may affect device reliability. Exceeding only one of these values may cause irreversible damage to the integrated circuit.*

¹ V_{CES} is similar to V_{CEO} due to design.

² V_{CBO} is similar to V_{CEO} due to design.

³ T_S is the soldering point temperature. T_S is measured on the emitter lead at the soldering point of the PCB.

Thermal characteristics

2 Thermal characteristics

Table 3 Thermal resistance

Parameter	Symbol	Values			Unit	Note or test condition
		Min.	Typ.	Max.		
Junction - soldering point	R_{thJS}	-	310	-	K/W	-

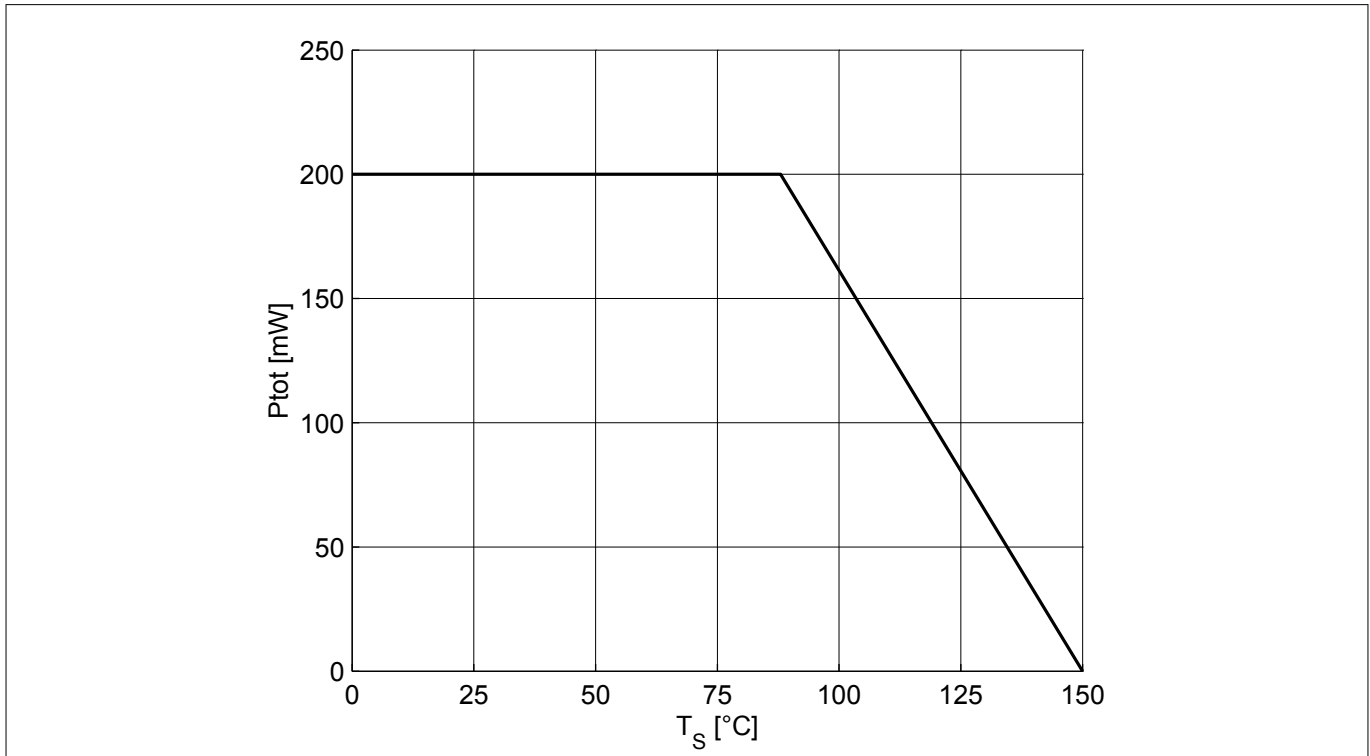

Figure 1 Total power dissipation $P_{tot} = f(T_S)$

Electrical characteristics

3 Electrical characteristics

3.1 DC characteristics

Table 4 DC characteristics at $T_A = 25\text{ }^\circ\text{C}$

Parameter	Symbol	Values			Unit	Note or test condition
		Min.	Typ.	Max.		
Collector emitter breakdown voltage	$V_{(BR)CEO}$	4.1	4.7	–	V	$I_C = 1\text{ mA}$, $I_B = 0$, open base
Collector emitter leakage current	I_{CES}	–	–	500 ⁴⁾	nA	$V_{CE} = 2\text{ V}$, $V_{BE} = 0$, E-B short circuited
Collector base leakage current	I_{CBO}			500 ⁴⁾		$V_{CB} = 2\text{ V}$, $I_E = 0$, open emitter
Emitter base leakage current	I_{EBO}			10 ⁴⁾	μA	$V_{EB} = 0.5\text{ V}$, $I_C = 0$, open collector
DC current gain	h_{FE}	110	180	270		$V_{CE} = 3\text{ V}$, $I_C = 30\text{ mA}$, pulse measured

3.2 General AC characteristics

Table 5 General AC characteristics at $T_A = 25\text{ }^\circ\text{C}$

Parameter	Symbol	Values			Unit	Note or test condition
		Min.	Typ.	Max.		
Transition frequency	f_T	–	45	–	GHz	$V_{CE} = 3\text{ V}$, $I_C = 30\text{ mA}$, $f = 1\text{ GHz}$
Collector base capacitance	C_{CB}		0.08		pF	$V_{CB} = 3\text{ V}$, $V_{BE} = 0$, $f = 1\text{ MHz}$, emitter grounded
Collector emitter capacitance	C_{CE}		0.4			$V_{CE} = 3\text{ V}$, $V_{BE} = 0$, $f = 1\text{ MHz}$, base grounded
Emitter base capacitance	C_{EB}		0.7			$V_{EB} = 0.4\text{ V}$, $V_{CB} = 0$, $f = 1\text{ MHz}$, collector grounded

⁴ Maximum values not limited by the device but by the short cycle time of the 100% test.

Electrical characteristics

3.3 Frequency dependent AC characteristics

Measurement setup is a test fixture with Bias-T's in a 50 Ω system, $T_A = 25\text{ °C}$.

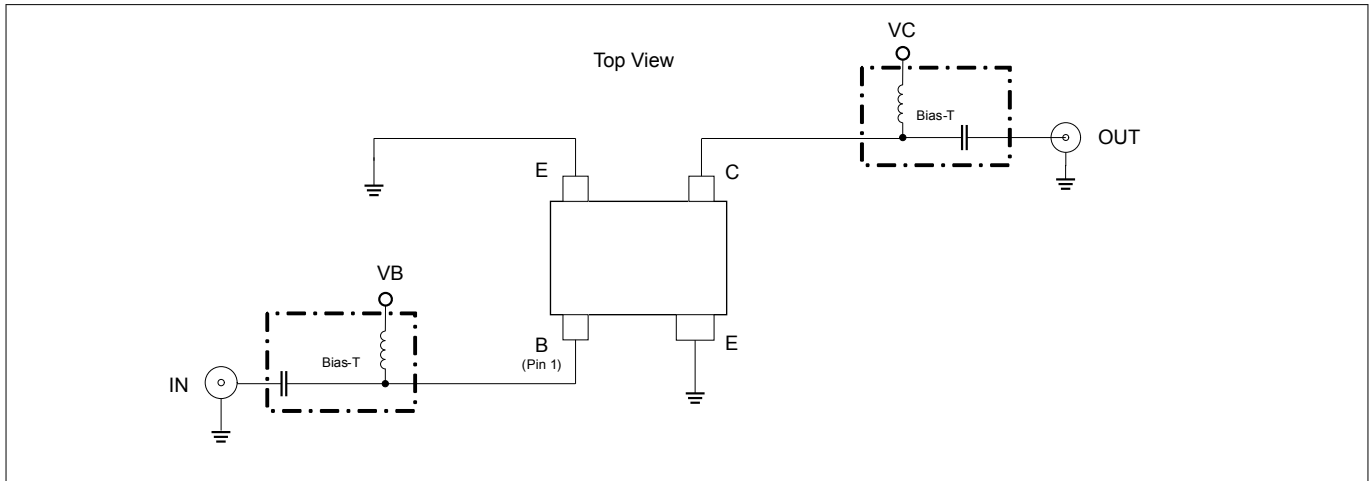

Figure 2 Testing circuit

Table 6 AC characteristics, $V_{CE} = 3\text{ V}$, $f = 150\text{ MHz}$

Parameter	Symbol	Values			Unit	Note or test condition
		Min.	Typ.	Max.		
Power gain		-	39.5	-	dB	$I_C = 30\text{ mA}$
<ul style="list-style-type: none"> Maximum power gain Transducer gain 	G_{ms} $ S_{21} ^2$					
Noise figure		-	0.6	-	dB	$I_C = 6\text{ mA}$
<ul style="list-style-type: none"> Minimum noise figure Associated gain 	NF_{min} G_{ass}					
Linearity		-	25	-	dBm	$I_C = 30\text{ mA}$, $Z_S = Z_L = 50\text{ }\Omega$
<ul style="list-style-type: none"> 3rd order intercept point at output 1 dB gain compression point at output 	OIP_3 OP_{1dB}					

Table 7 AC characteristics, $V_{CE} = 3\text{ V}$, $f = 450\text{ MHz}$

Parameter	Symbol	Values			Unit	Note or test condition
		Min.	Typ.	Max.		
Power gain		-	34.5	-	dB	$I_C = 30\text{ mA}$
<ul style="list-style-type: none"> Maximum power gain Transducer gain 	G_{ms} $ S_{21} ^2$					
Noise figure		-	0.6	-	dB	$I_C = 6\text{ mA}$
<ul style="list-style-type: none"> Minimum noise figure Associated gain 	NF_{min} G_{ass}					
Linearity		-	25	-	dBm	$I_C = 30\text{ mA}$, $Z_S = Z_L = 50\text{ }\Omega$
<ul style="list-style-type: none"> 3rd order intercept point at output 1 dB gain compression point at output 	OIP_3 OP_{1dB}					

Electrical characteristics

Table 8 AC characteristics, $V_{CE} = 3\text{ V}$, $f = 900\text{ MHz}$

Parameter	Symbol	Values			Unit	Note or test condition
		Min.	Typ.	Max.		
Power gain	G_{ms} $ S_{21} ^2$	–	30.5	–	dB	$I_C = 30\text{ mA}$
<ul style="list-style-type: none"> Maximum power gain Transducer gain 			28			
Noise figure	NF_{min} G_{ass}	–	0.6	–	dBm	$I_C = 6\text{ mA}$
<ul style="list-style-type: none"> Minimum noise figure Associated gain 			26			
Linearity	OIP_3 OP_{1dB}	–	26	–	dBm	$I_C = 30\text{ mA}$, $Z_S = Z_L = 50\ \Omega$
<ul style="list-style-type: none"> 3rd order intercept point at output 1 dB gain compression point at output 			11.5			

Table 9 AC characteristics, $V_{CE} = 3\text{ V}$, $f = 1.5\text{ GHz}$

Parameter	Symbol	Values			Unit	Note or test condition
		Min.	Typ.	Max.		
Power gain	G_{ms} $ S_{21} ^2$	–	26.5	–	dB	$I_C = 30\text{ mA}$
<ul style="list-style-type: none"> Maximum power gain Transducer gain 			24			
Noise figure	NF_{min} G_{ass}	–	0.65	–	dBm	$I_C = 6\text{ mA}$
<ul style="list-style-type: none"> Minimum noise figure Associated gain 			23.5			
Linearity	OIP_3 OP_{1dB}	–	26.5	–	dBm	$I_C = 30\text{ mA}$, $Z_S = Z_L = 50\ \Omega$
<ul style="list-style-type: none"> 3rd order intercept point at output 1 dB gain compression point at output 			12			

Table 10 AC characteristics, $V_{CE} = 3\text{ V}$, $f = 1.9\text{ GHz}$

Parameter	Symbol	Values			Unit	Note or test condition
		Min.	Typ.	Max.		
Power gain	G_{ms} $ S_{21} ^2$	–	25	–	dB	$I_C = 30\text{ mA}$
<ul style="list-style-type: none"> Maximum power gain Transducer gain 			22			
Noise figure	NF_{min} G_{ass}	–	0.65	–	dBm	$I_C = 6\text{ mA}$
<ul style="list-style-type: none"> Minimum noise figure Associated gain 			22			
Linearity	OIP_3 OP_{1dB}	–	27	–	dBm	$I_C = 30\text{ mA}$, $Z_S = Z_L = 50\ \Omega$
<ul style="list-style-type: none"> 3rd order intercept point at output 1 dB gain compression point at output 			12			

Electrical characteristics

Table 11 AC characteristics, $V_{CE} = 3\text{ V}$, $f = 2.4\text{ GHz}$

Parameter	Symbol	Values			Unit	Note or test condition
		Min.	Typ.	Max.		
Power gain	G_{ms} $ S_{21} ^2$	-	23	-	dB	$I_C = 30\text{ mA}$
<ul style="list-style-type: none"> Maximum power gain Transducer gain 			20			
Noise figure	NF_{min} G_{ass}		0.7			$I_C = 6\text{ mA}$
<ul style="list-style-type: none"> Minimum noise figure Associated gain 			20			
Linearity	OIP_3 OP_{1dB}		27		dBm	$I_C = 30\text{ mA}$, $Z_S = Z_L = 50\ \Omega$
<ul style="list-style-type: none"> 3rd order intercept point at output 1 dB gain compression point at output 			12.5			

Table 12 AC characteristics, $V_{CE} = 3\text{ V}$, $f = 3.5\text{ GHz}$

Parameter	Symbol	Values			Unit	Note or test condition
		Min.	Typ.	Max.		
Power gain	G_{ms} $ S_{21} ^2$	-	19	-	dB	$I_C = 30\text{ mA}$
<ul style="list-style-type: none"> Maximum power gain Transducer gain 			17			
Noise figure	NF_{min} G_{ass}		0.8			$I_C = 6\text{ mA}$
<ul style="list-style-type: none"> Minimum noise figure Associated gain 			16			
Linearity	OIP_3 OP_{1dB}		26.5		dBm	$I_C = 30\text{ mA}$, $Z_S = Z_L = 50\ \Omega$
<ul style="list-style-type: none"> 3rd order intercept point at output 1 dB gain compression point at output 			12.5			

Table 13 AC characteristics, $V_{CE} = 3\text{ V}$, $f = 5.5\text{ GHz}$

Parameter	Symbol	Values			Unit	Note or test condition
		Min.	Typ.	Max.		
Power gain	G_{ms} $ S_{21} ^2$	-	14.5	-	dB	$I_C = 30\text{ mA}$
<ul style="list-style-type: none"> Maximum power gain Transducer gain 			12.5			
Noise figure	NF_{min} G_{ass}		1.05			$I_C = 6\text{ mA}$
<ul style="list-style-type: none"> Minimum noise figure Associated gain 			11.5			
Linearity	OIP_3 OP_{1dB}		26		dBm	$I_C = 30\text{ mA}$, $Z_S = Z_L = 50\ \Omega$
<ul style="list-style-type: none"> 3rd order intercept point at output 1 dB gain compression point at output 			12.5			

Electrical characteristics

Table 14 AC characteristics, $V_{CE} = 3\text{ V}$, $f = 10\text{ GHz}$

Parameter	Symbol	Values			Unit	Note or test condition		
		Min.	Typ.	Max.				
Power gain		-	10.5	-	dB	$I_C = 30\text{ mA}$		
<ul style="list-style-type: none"> Maximum power gain Transducer gain 	G_{ms} $ S_{21} ^2$						6	
Noise figure					2	7	dBm	$I_C = 6\text{ mA}$
<ul style="list-style-type: none"> Minimum noise figure Associated gain 	NF_{min} G_{ass}							
Linearity			25.5			$I_C = 30\text{ mA}$, $Z_S = Z_L = 50\ \Omega$		
<ul style="list-style-type: none"> 3rd order intercept point at output 1 dB gain compression point at output 	OIP_3 OP_{1dB}		11					

Note: $G_{ms} = |S_{21}/S_{12}|$ for $k < 1$; $G_{ma} = |S_{21}/S_{12}|(k-(k^2-1)^{1/2})$ for $k > 1$. In order to get the NF_{min} values stated in this chapter, the test fixture losses have been subtracted from all measured results. OIP_3 value depends on termination of all intermodulation frequency components. Termination used for this measurement is $50\ \Omega$ from 0.2 MHz to 12 GHz.

Electrical characteristics

3.4 Characteristic DC diagrams

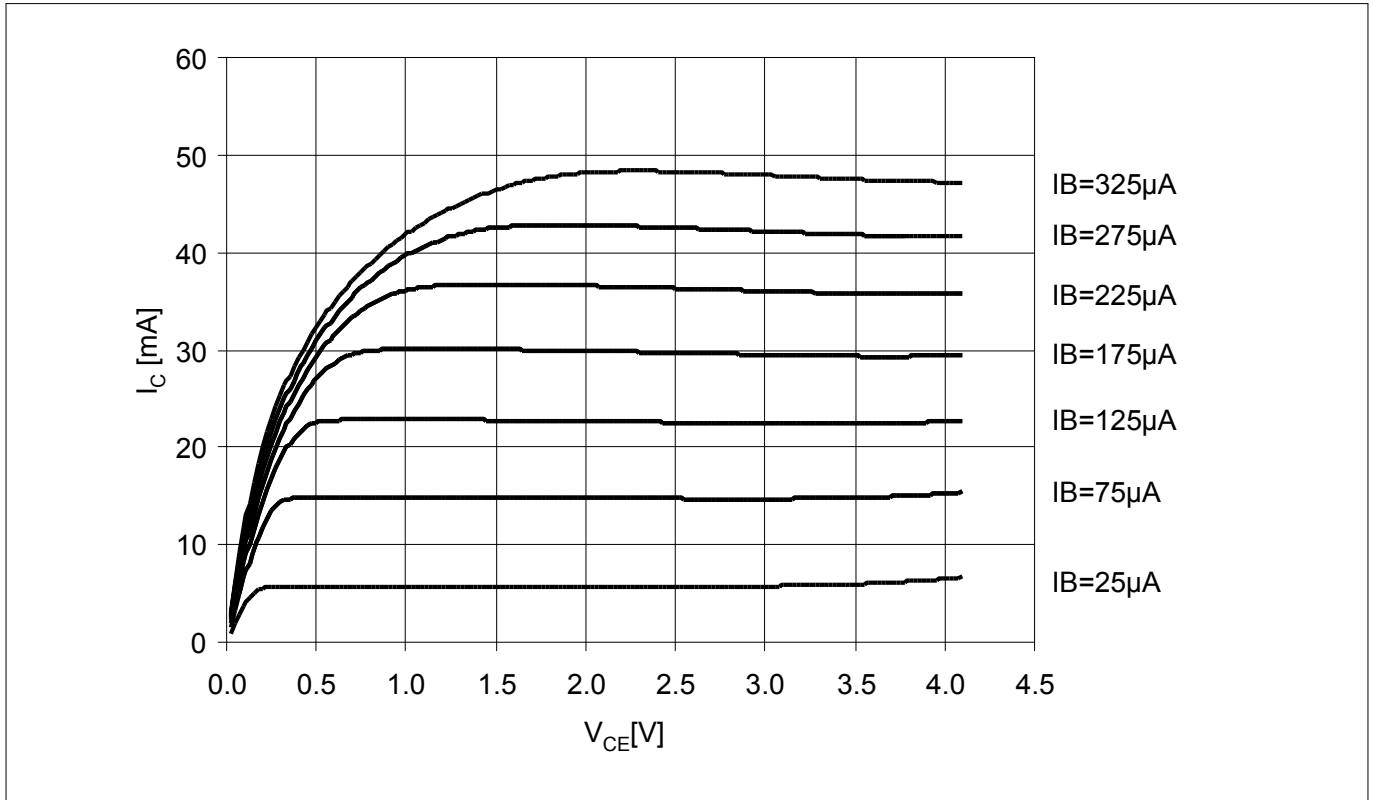

Figure 3 Collector current vs. collector emitter voltage $I_C = f(V_{CE})$, $I_B = \text{parameter}$

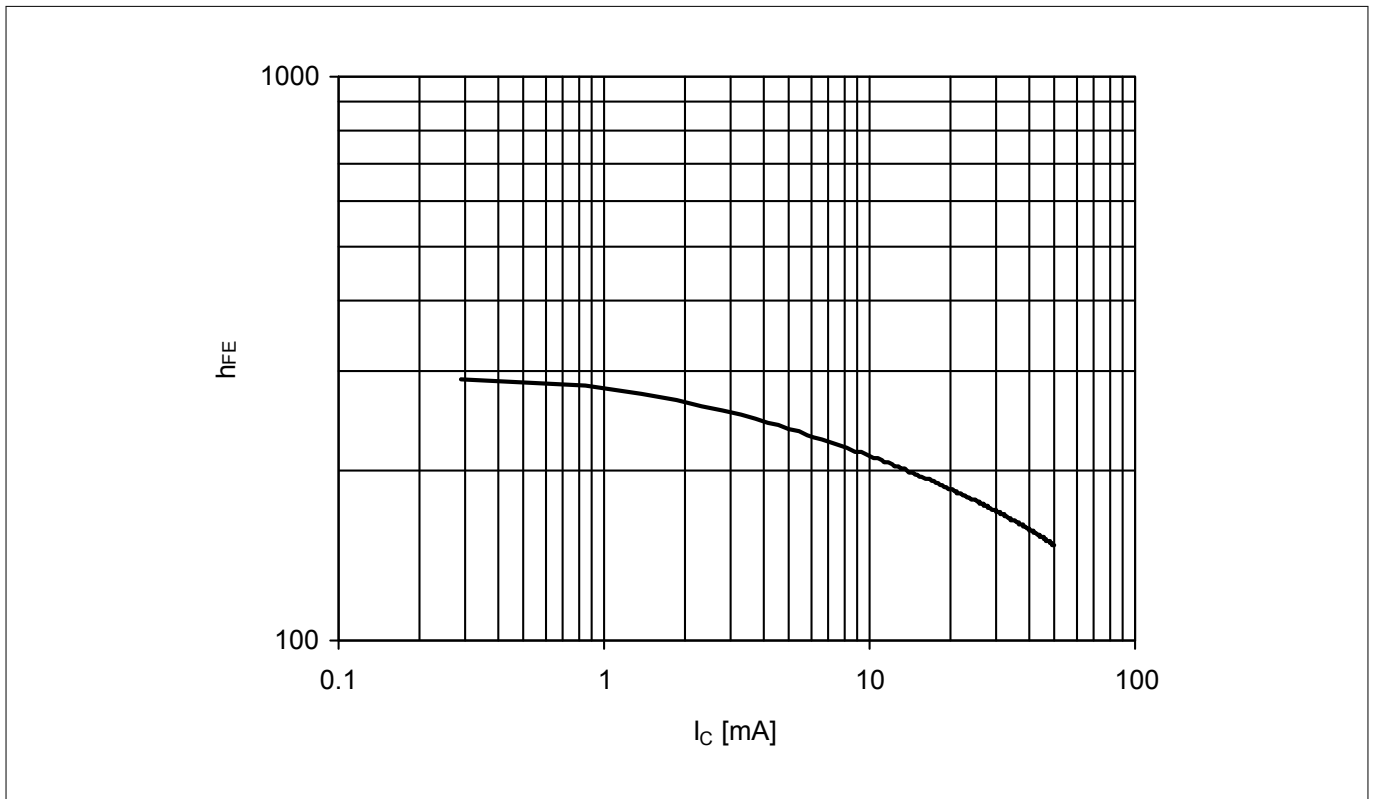

Figure 4 DC current gain $h_{FE} = f(I_C)$, $V_{CE} = 3 \text{ V}$

Electrical characteristics

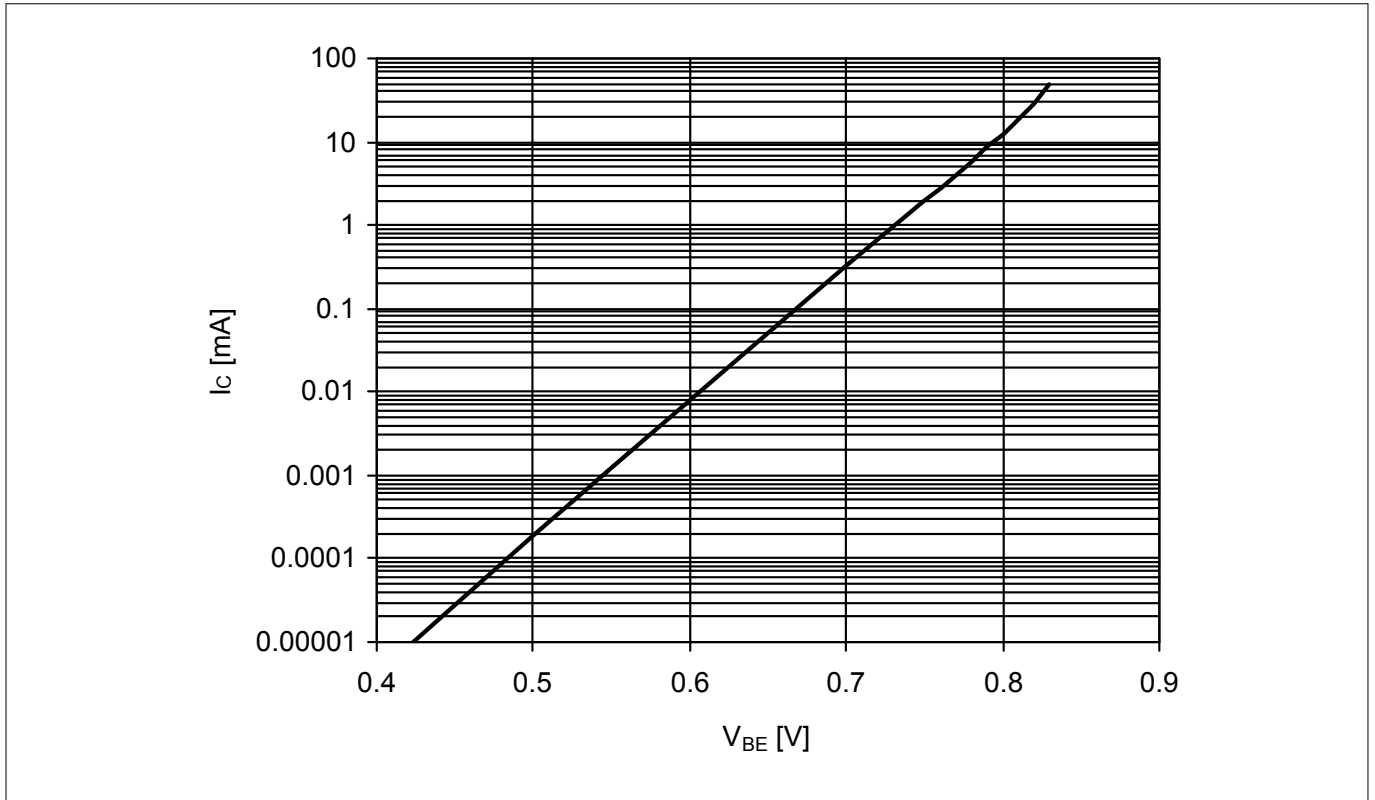

Figure 5 Collector current vs. base emitter forward voltage $I_C = f(V_{BE}), V_{CE} = 2\text{ V}$

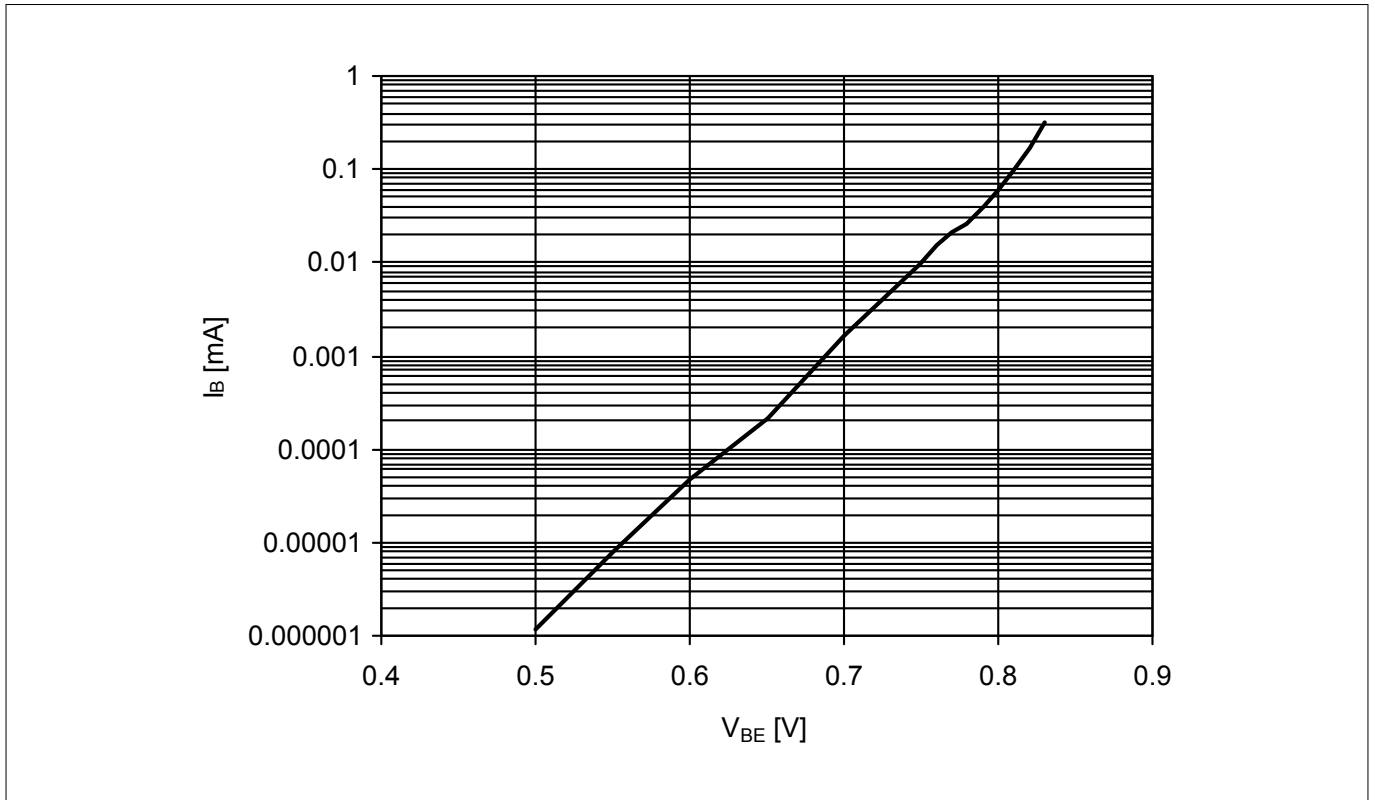

Figure 6 Base current vs. base emitter forward voltage $I_B = f(V_{BE}), V_{CE} = 2\text{ V}$

Electrical characteristics

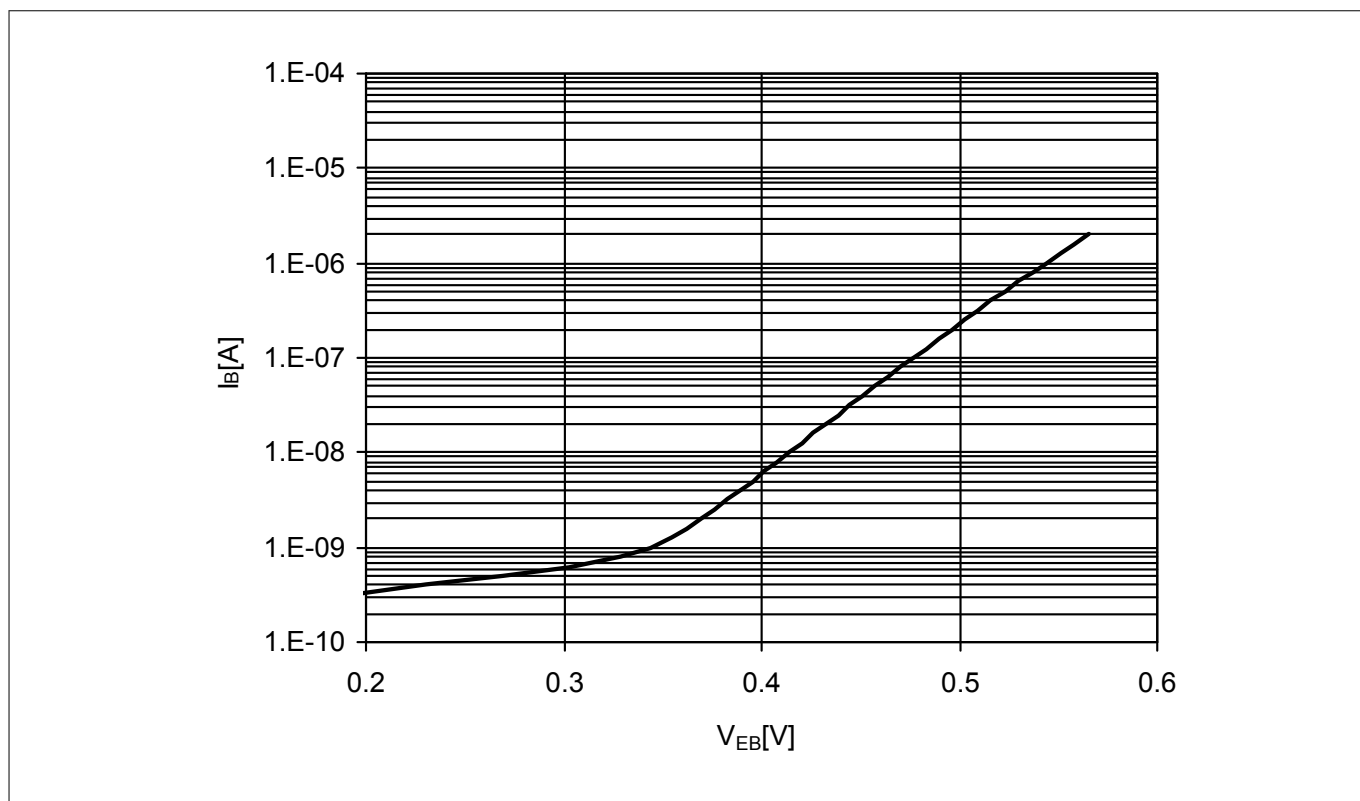

Figure 7 Base current vs. base emitter reverse voltage $I_B = f(V_{EB})$, $V_{CE} = 2\text{ V}$

Electrical characteristics

3.5 Characteristic AC diagrams

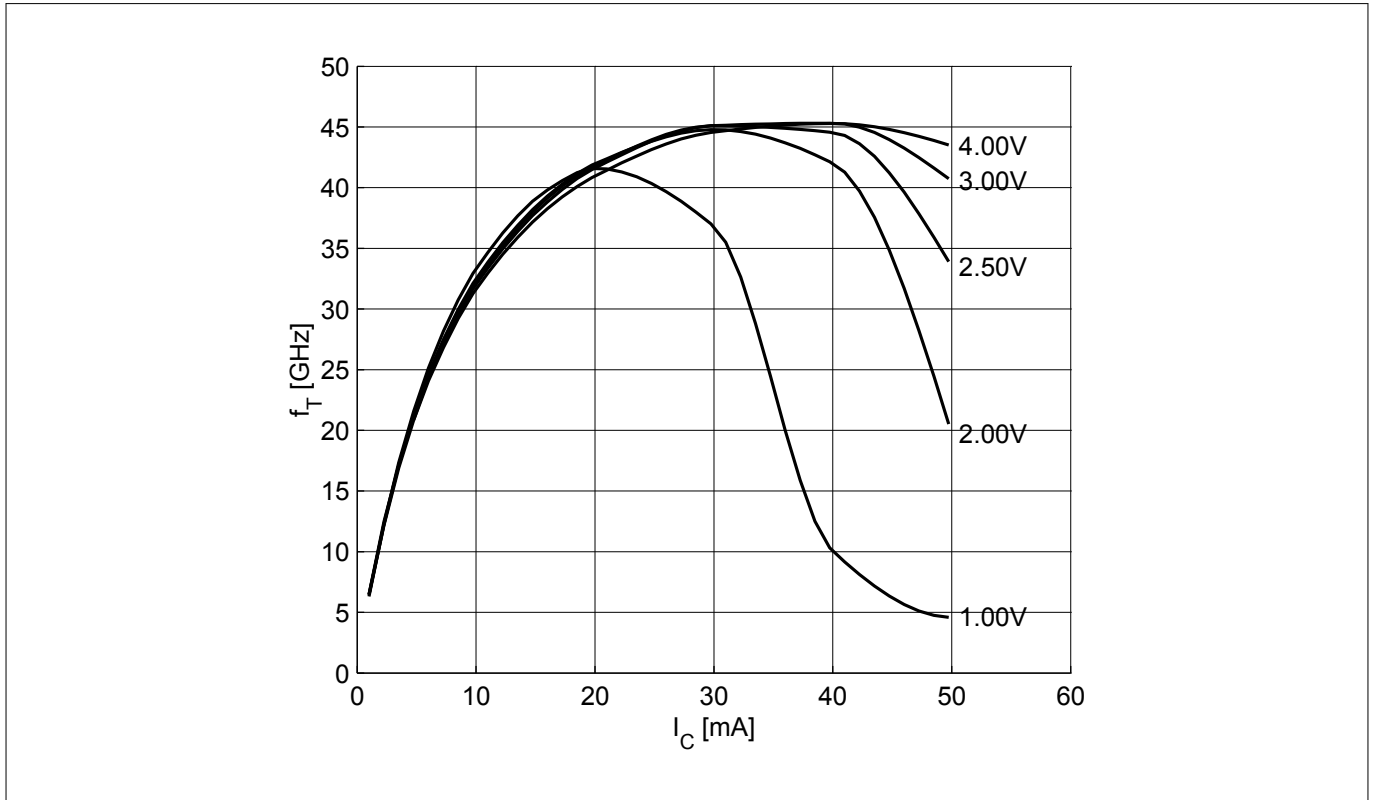

Figure 8 Transition frequency $f_T = f(I_C)$, $f = 1 \text{ GHz}$, $V_{CE} = \text{parameter}$

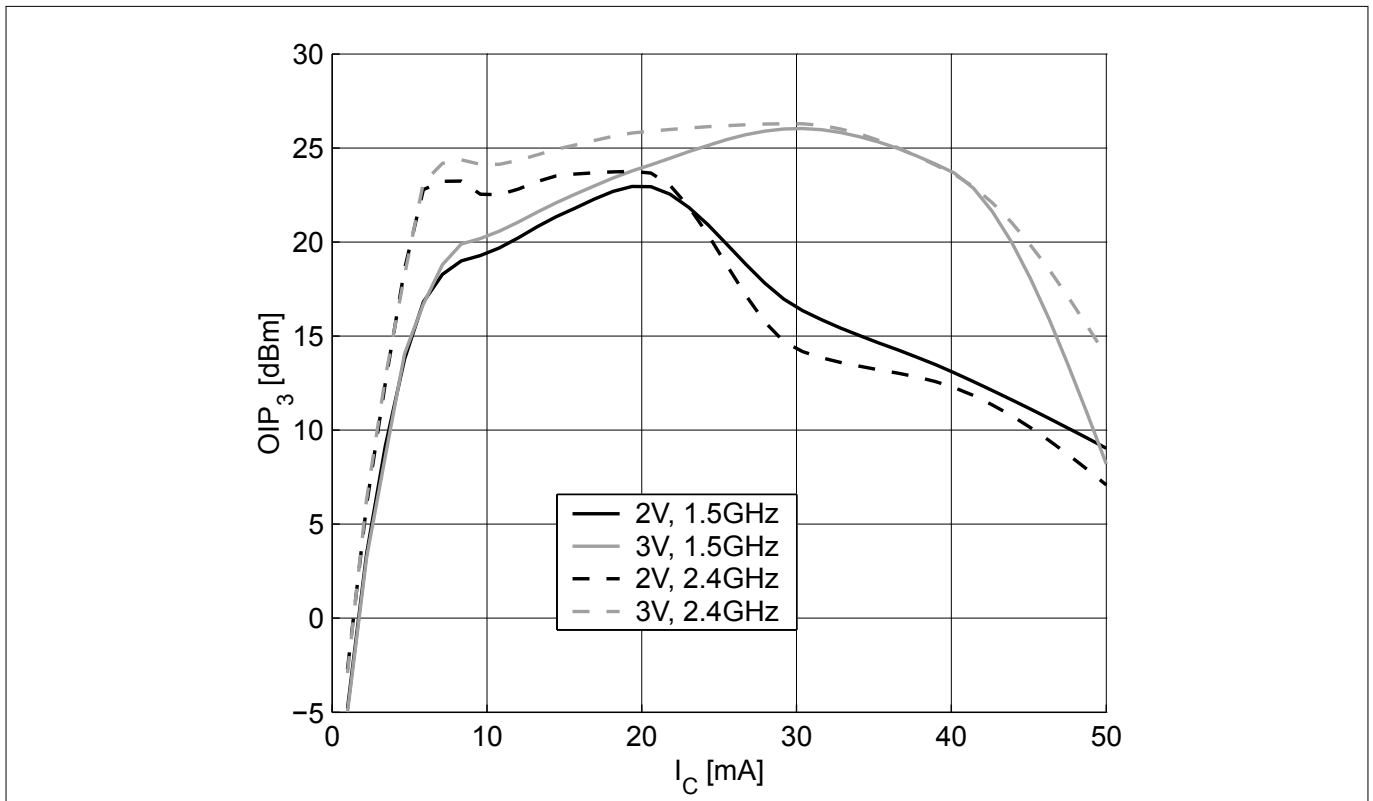

Figure 9 3rd order intercept point $OIP_3 = f(I_C)$, $Z_S = Z_L = 50 \Omega$, V_{CE} , $f = \text{parameters}$

Electrical characteristics

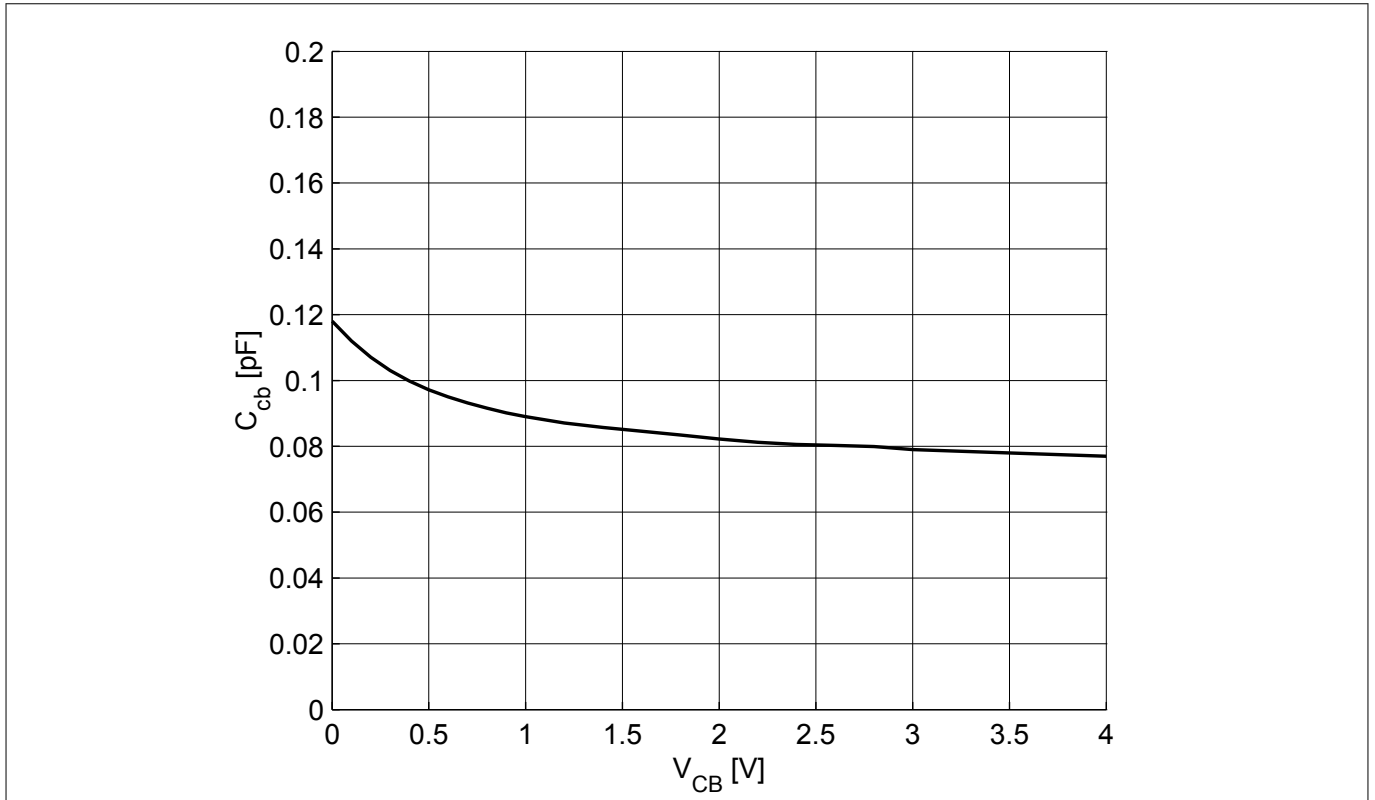

Figure 10 Collector base capacitance $C_{CB} = f(V_{CB})$, $f = 1$ MHz

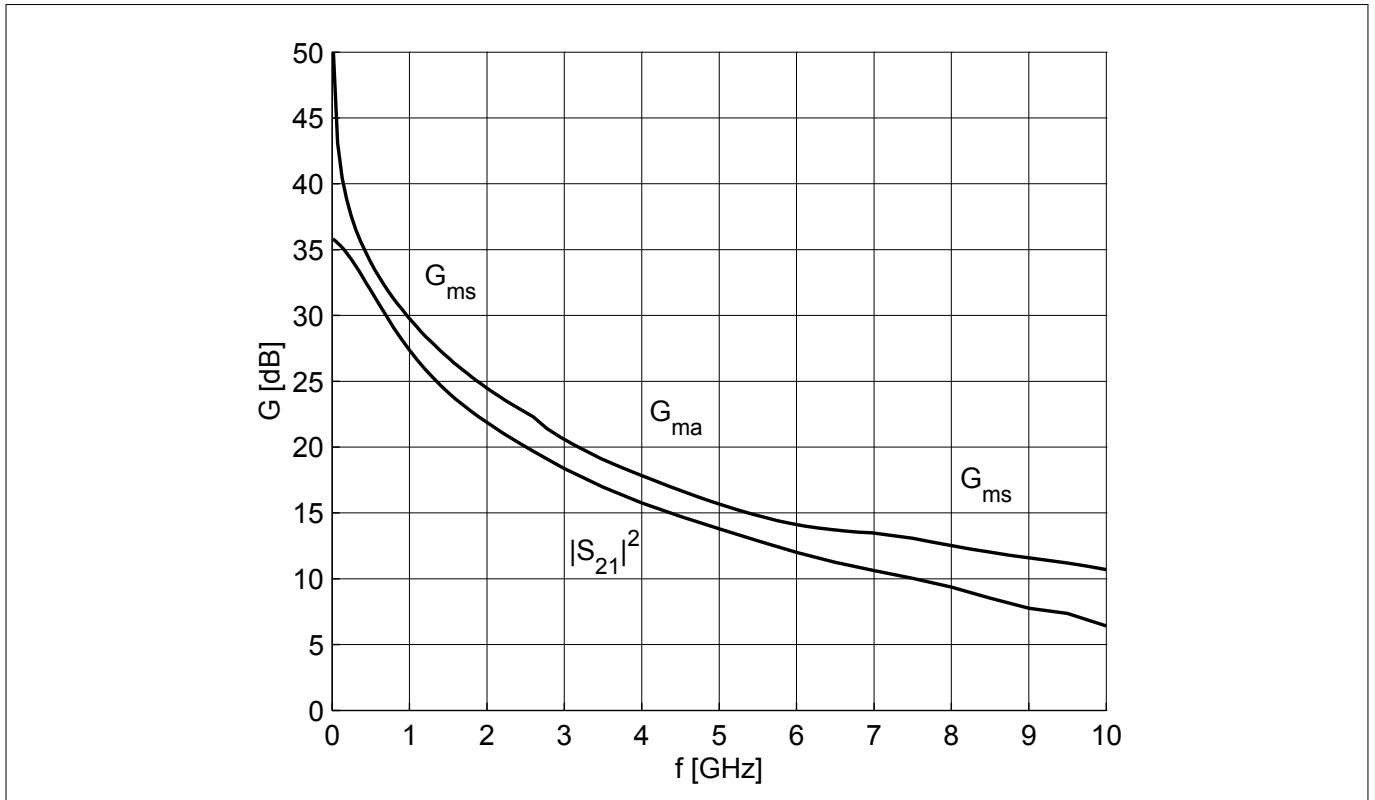

Figure 11 Gain G_{ma} , G_{ms} , $|S_{21}|^2 = f(f)$, $V_{CE} = 3$ V, $I_C = 30$ mA

Electrical characteristics

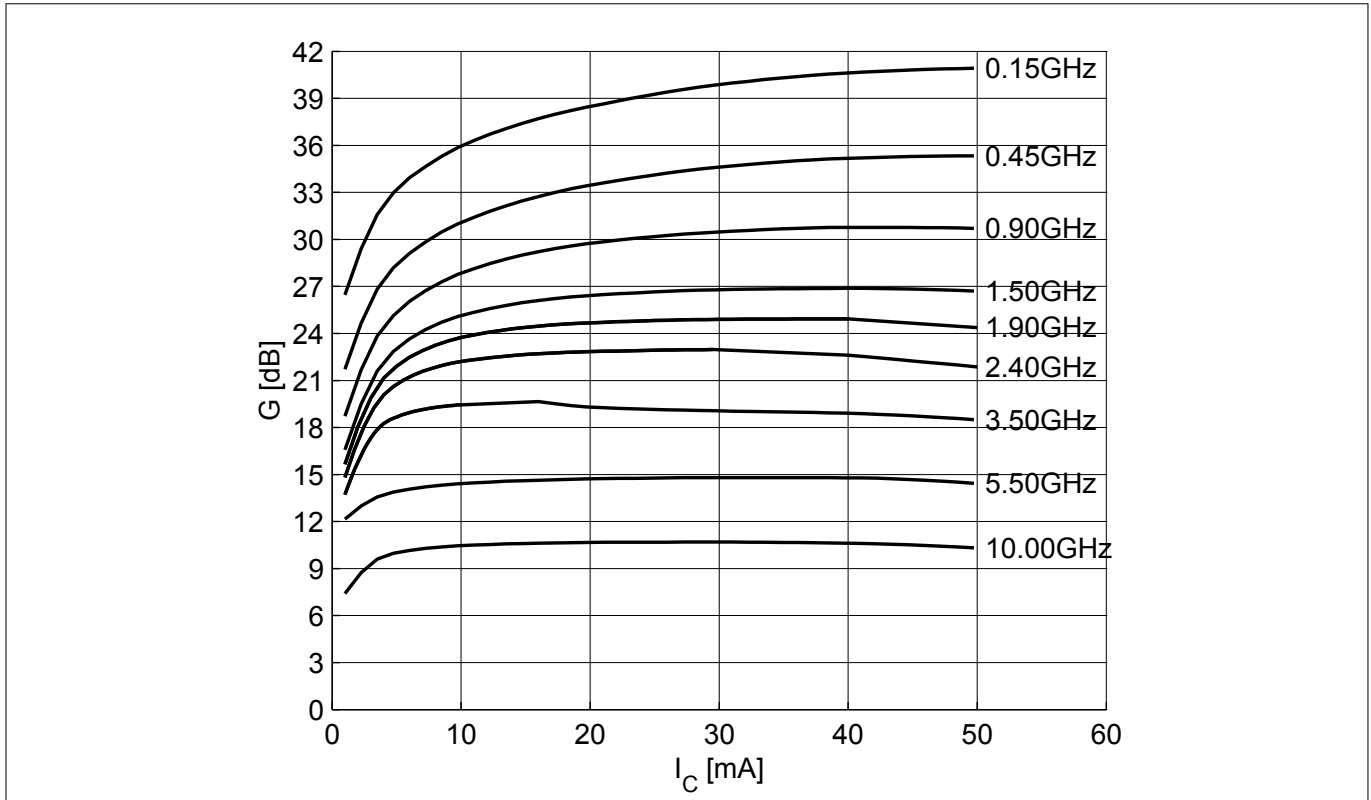

Figure 12 Maximum power gain $G_{max} = f(I_C)$, $V_{CE} = 3\text{ V}$, $f = \text{parameter in GHz}$

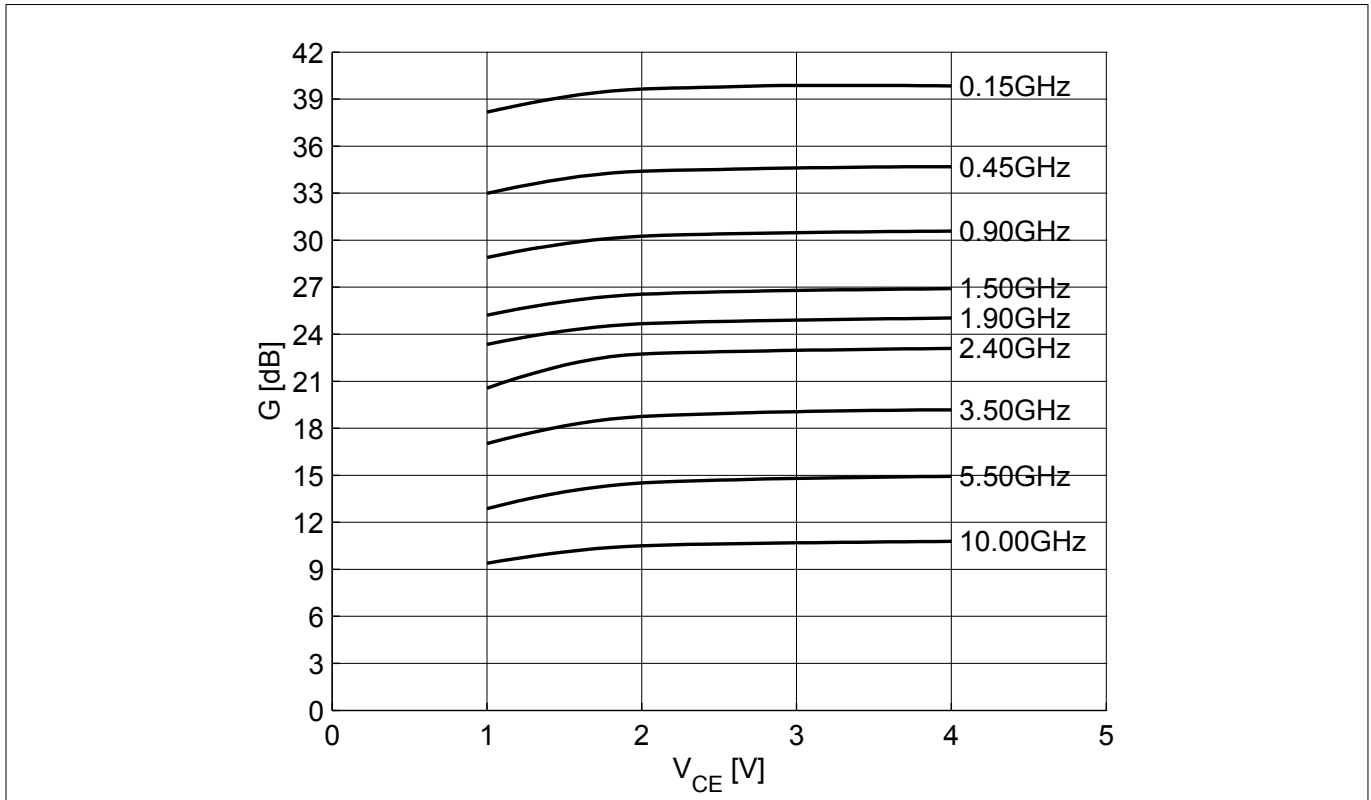

Figure 13 Maximum power gain $G_{max} = f(V_{CE})$, $I_C = 30\text{ mA}$, $f = \text{parameter in GHz}$

Electrical characteristics

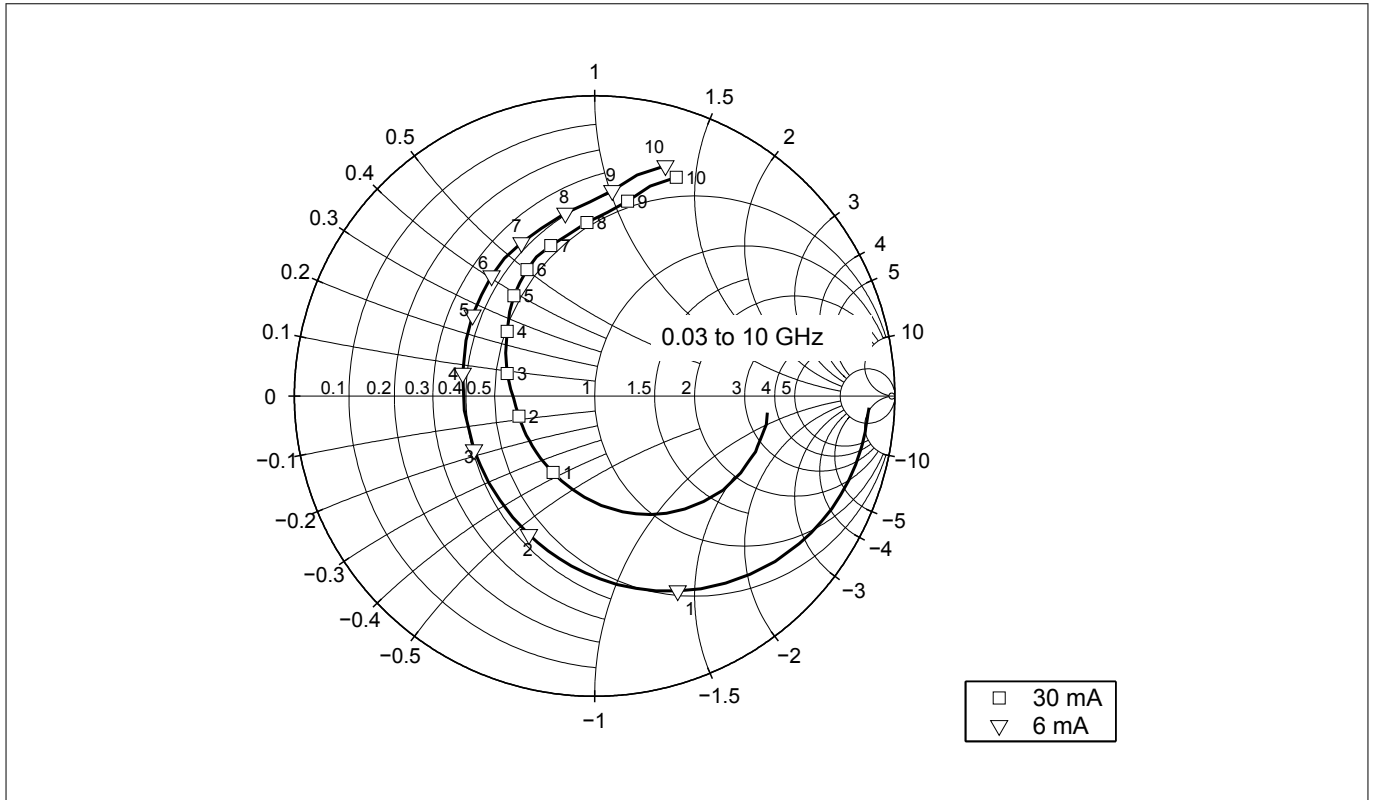

Figure 14 Input reflection coefficient $S_{11} = f(f)$, $V_{CE} = 3\text{ V}$, $I_C = 6 / 30\text{ mA}$

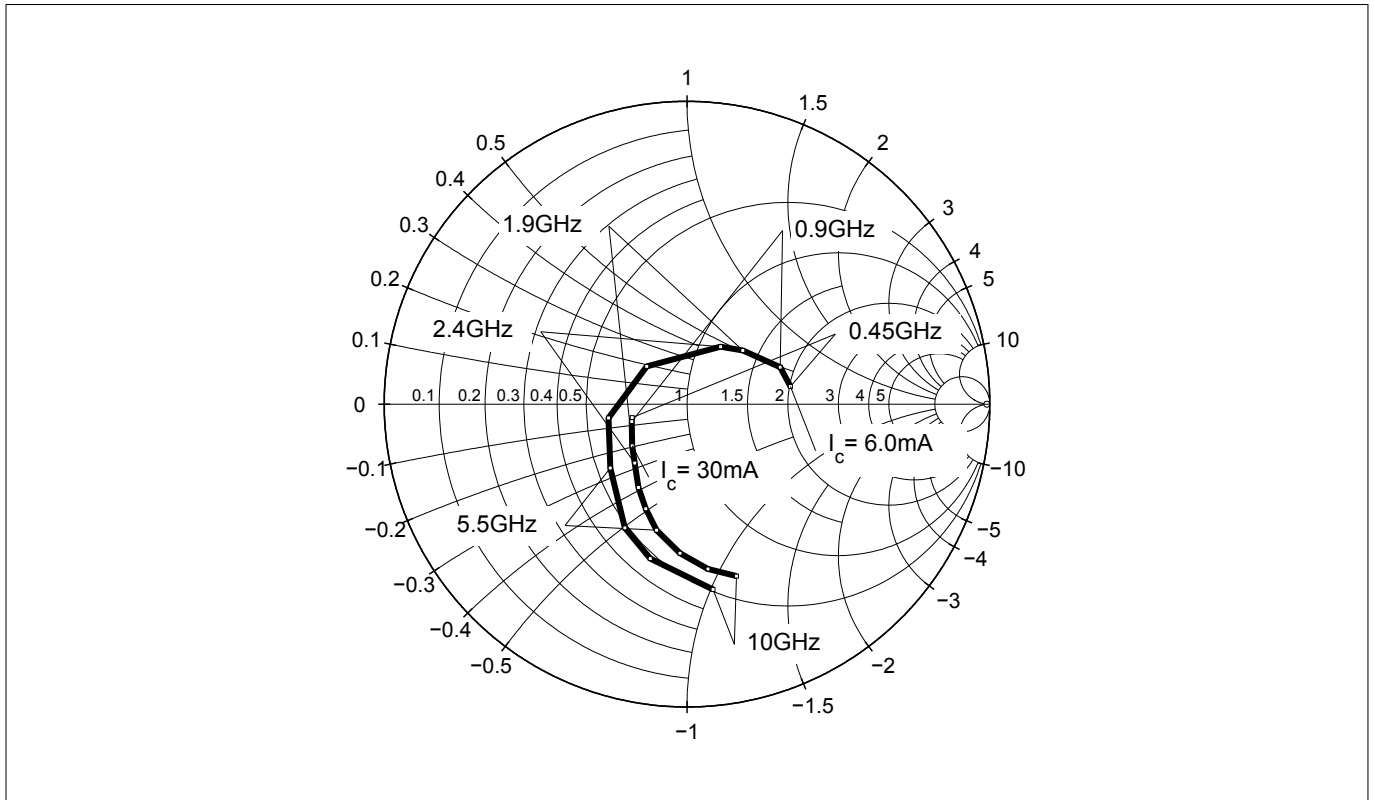

Figure 15 Source impedance for minimum noise figure $Z_{S,opt} = f(f)$, $V_{CE} = 3\text{ V}$, $I_C = 6 / 30\text{ mA}$

Electrical characteristics

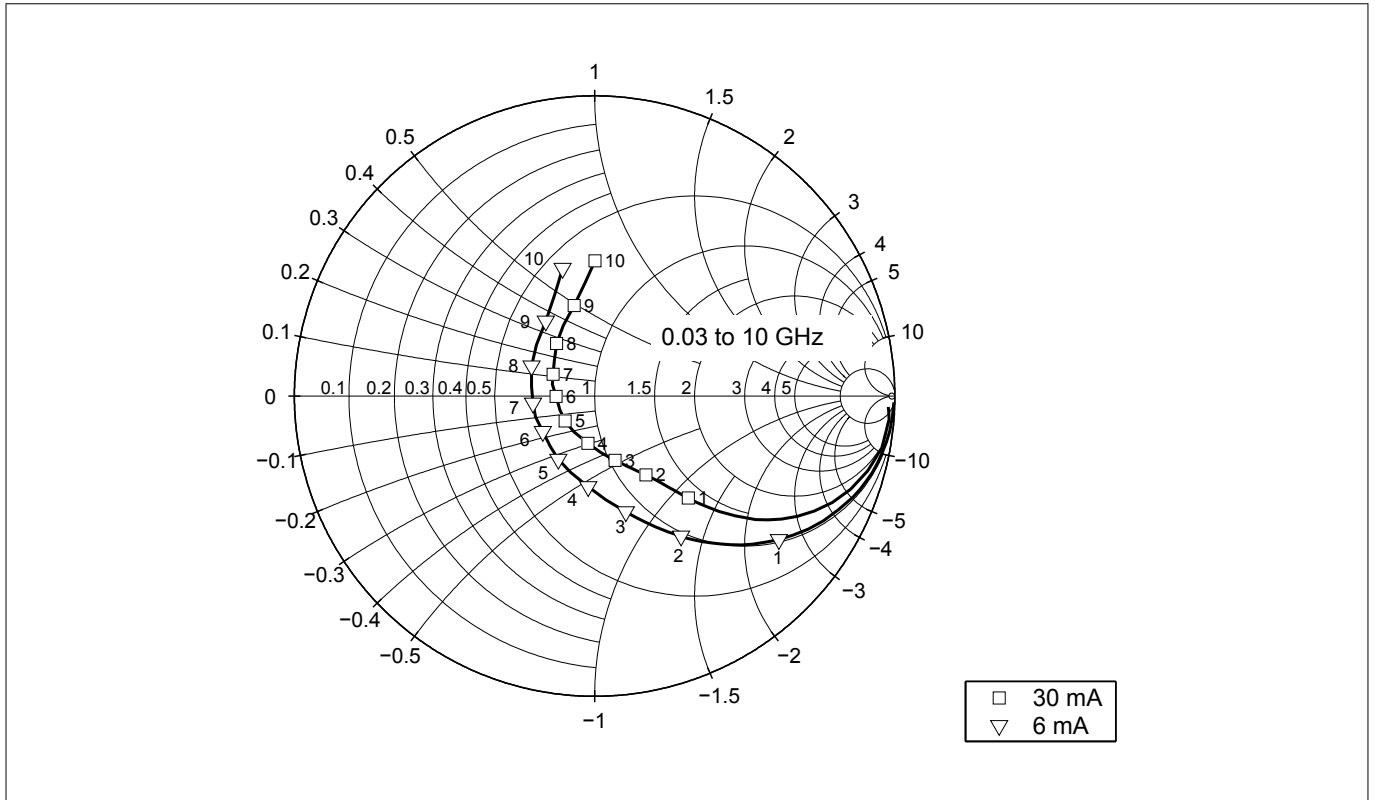

Figure 16 Output reflection coefficient $S_{22} = f(f)$, $V_{CE} = 3\text{ V}$, $I_C = 6 / 30\text{ mA}$

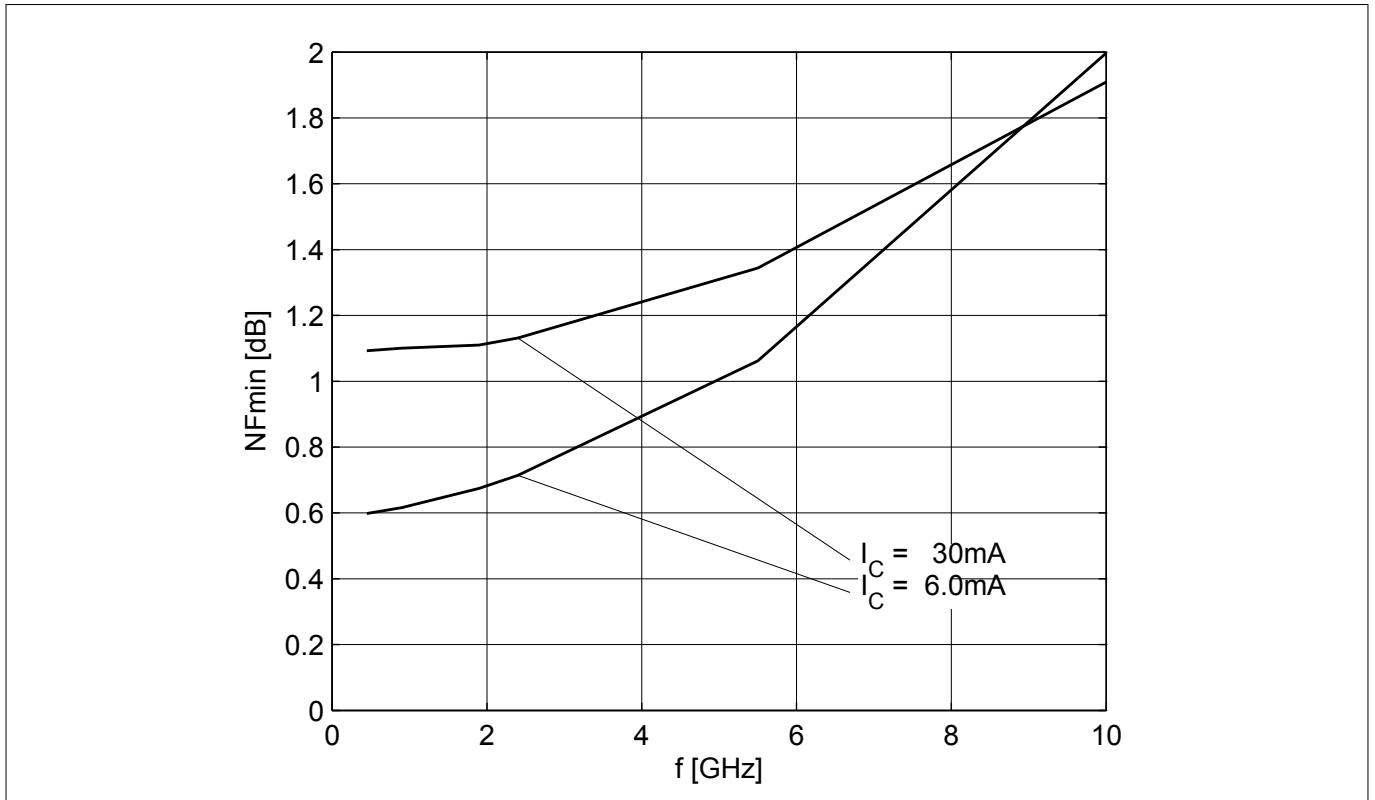

Figure 17 Noise figure $NF_{min} = f(f)$, $Z_S = Z_{S,opt}$, $V_{CE} = 3\text{ V}$, $I_C = 6 / 30\text{ mA}$

Electrical characteristics

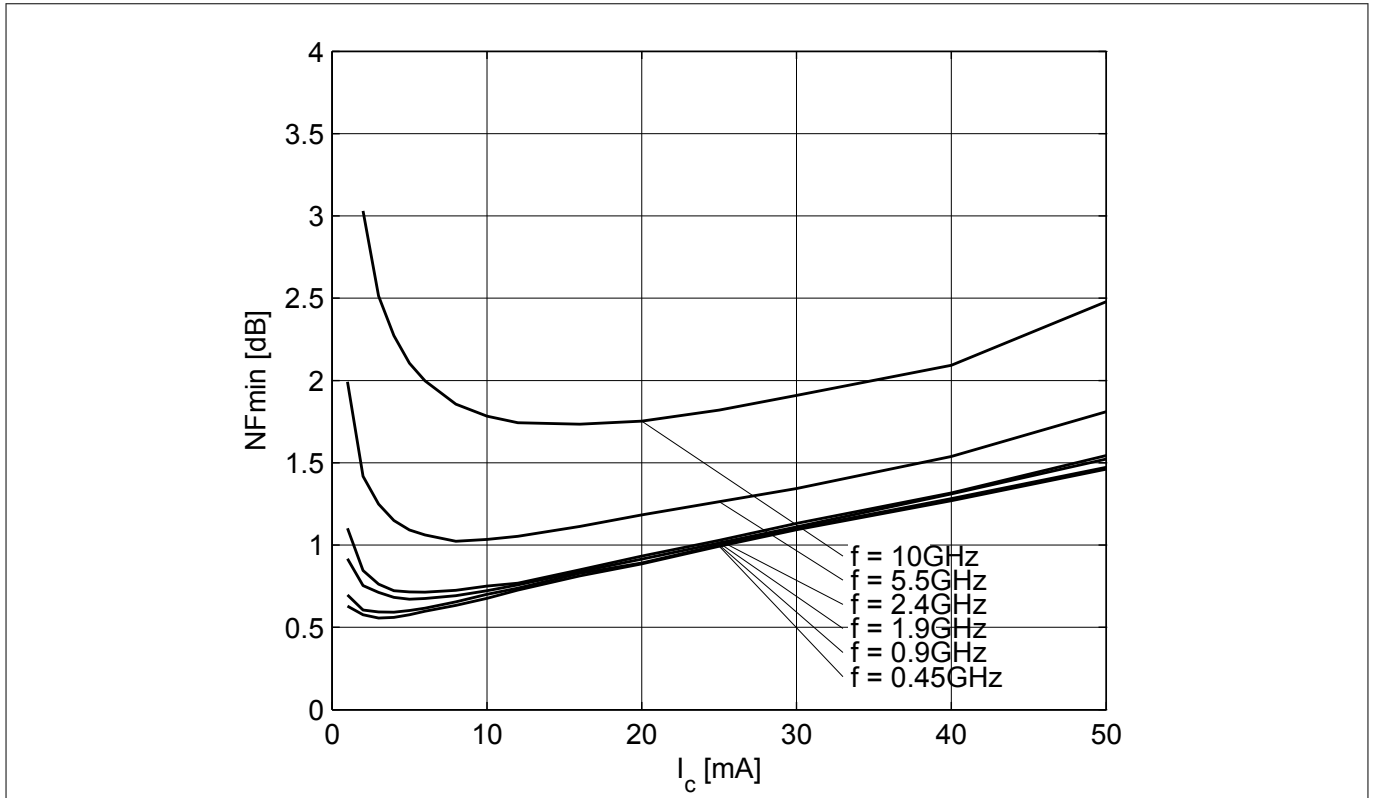

Figure 18 Noise figure $NF_{min} = f(I_C), Z_S = Z_{S,opt}, V_{CE} = 3\text{ V}, f = \text{parameter in GHz}$

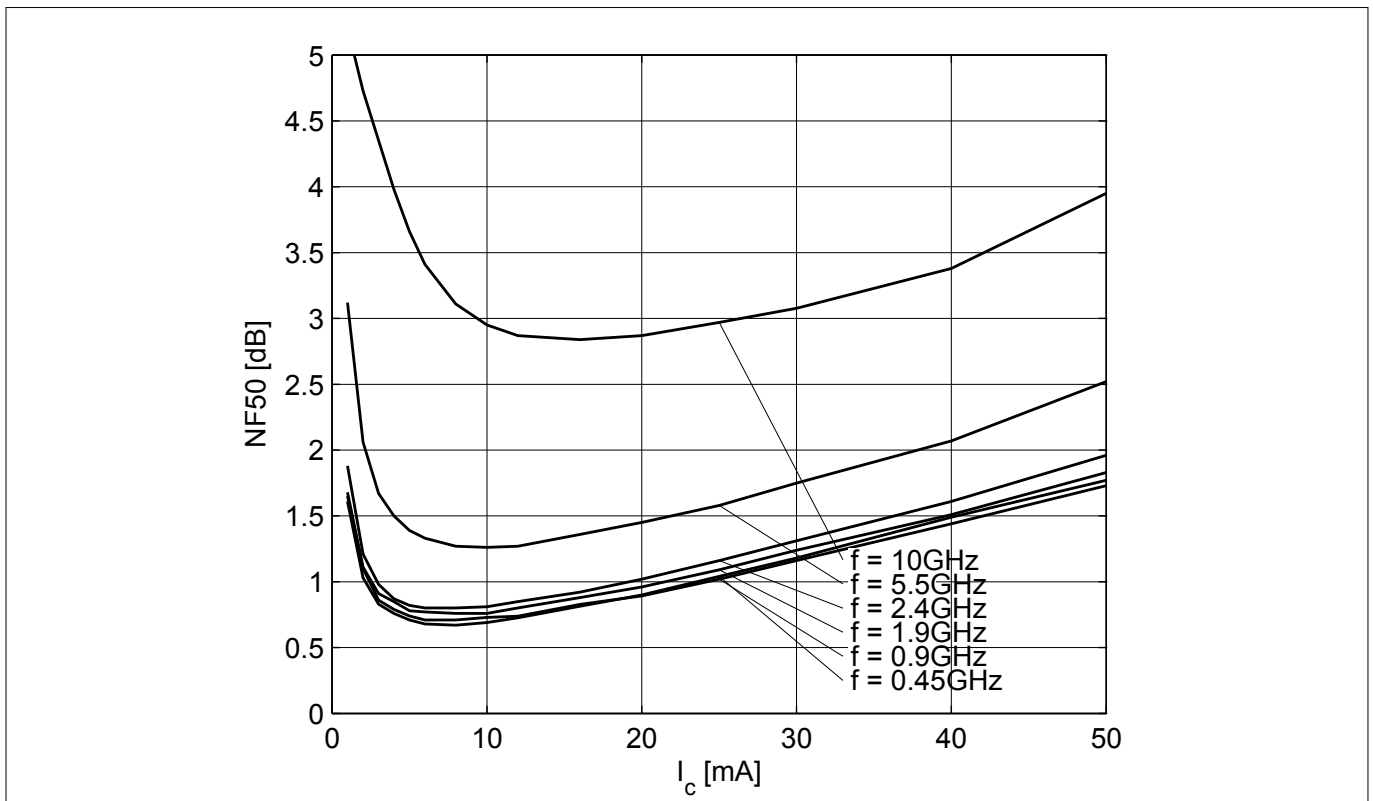

Figure 19 Noise figure $NF_{50} = f(I_C), Z_S = 50\ \Omega, V_{CE} = 3\text{ V}, f = \text{parameter in GHz}$

Note: The curves shown in this chapter have been generated using typical devices but shall not be considered as a guarantee that all devices have identical characteristic curves. $T_A = 25\text{ }^\circ\text{C}$.

Package information SOT343

4 Package information SOT343

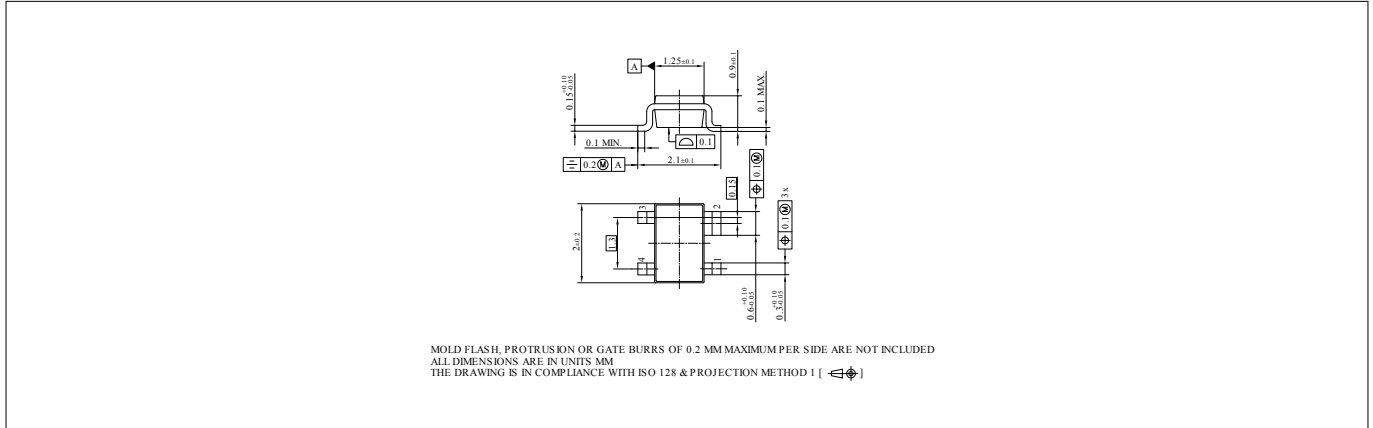

Figure 20 Package outline

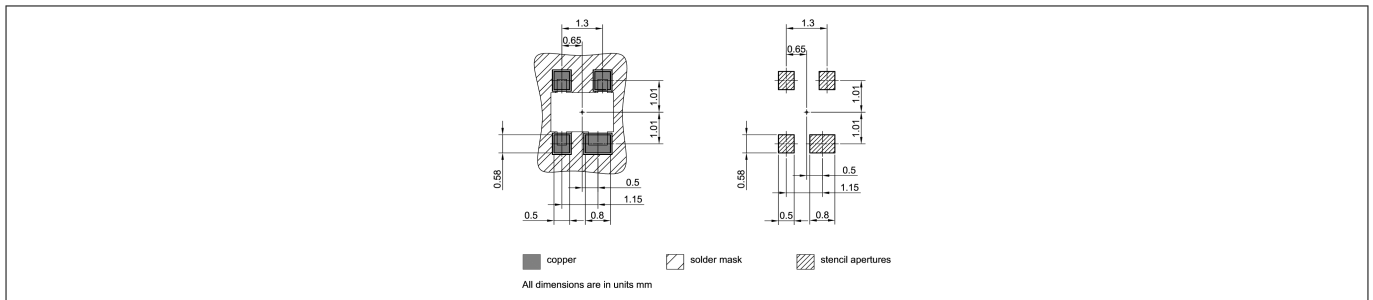

Figure 21 Foot print

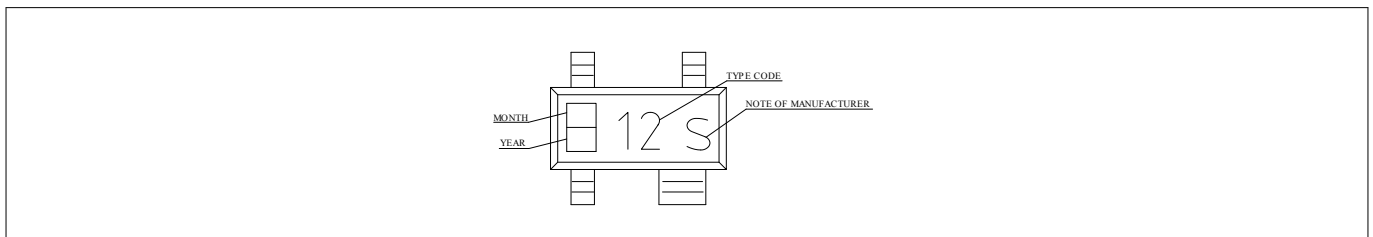

Figure 22 Marking layout example

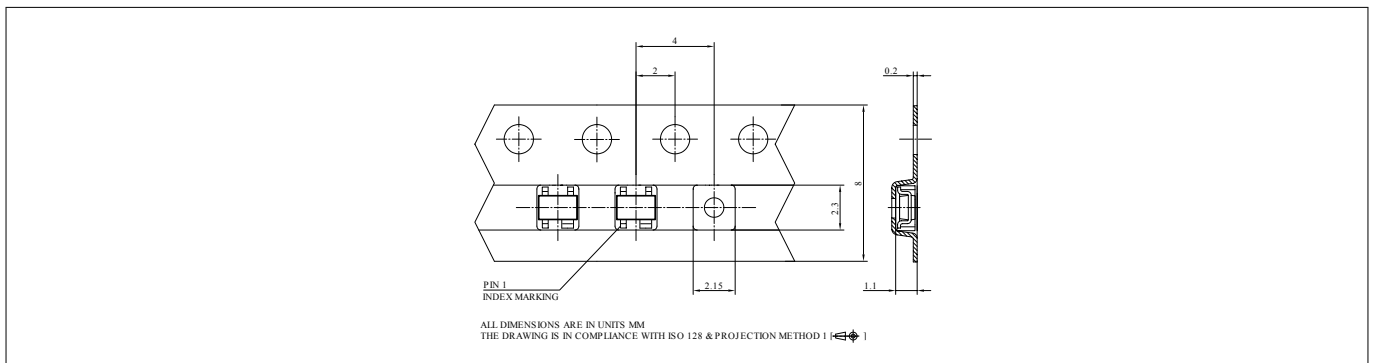

Figure 23 Tape dimensions

Revision history

Revision history

Document version	Date of release	Description of changes
Revision 2.0	2019-01-25	New datasheet layout.

Trademarks

All referenced product or service names and trademarks are the property of their respective owners.

Edition 2019-01-25

**Published by
Infineon Technologies AG
81726 Munich, Germany**

**© 2019 Infineon Technologies AG
All Rights Reserved.**

**Do you have a question about any
aspect of this document?
Email: erratum@infineon.com**

**Document reference
IFX-gxy1526293410079**

IMPORTANT NOTICE

The information given in this document shall in no event be regarded as a guarantee of conditions or characteristics ("Beschaffheitsgarantie").

With respect to any examples, hints or any typical values stated herein and/or any information regarding the application of the product, Infineon Technologies hereby disclaims any and all warranties and liabilities of any kind, including without limitation warranties of non-infringement of intellectual property rights of any third party.

In addition, any information given in this document is subject to customer's compliance with its obligations stated in this document and any applicable legal requirements, norms and standards concerning customer's products and any use of the product of Infineon Technologies in customer's applications.

The data contained in this document is exclusively intended for technically trained staff. It is the responsibility of customer's technical departments to evaluate the suitability of the product for the intended application and the completeness of the product information given in this document with respect to such application.

WARNINGS

Due to technical requirements products may contain dangerous substances. For information on the types in question please contact your nearest Infineon Technologies office.

Except as otherwise explicitly approved by Infineon Technologies in a written document signed by authorized representatives of Infineon Technologies, Infineon Technologies' products may not be used in any applications where a failure of the product or any consequences of the use thereof can reasonably be expected to result in personal injury

X-ON Electronics

Largest Supplier of Electrical and Electronic Components

Click to view similar products for [RF Bipolar Transistors](#) category:

Click to view products by [Infineon](#) manufacturer:

Other Similar products are found below :

[MAPRST0912-50](#) [MCH4016-TL-H](#) [MMBT5551-G](#) [MRF10120](#) [15GN01CA-TB-E](#) [PH1214-25M](#) [MAPRST0912-350](#) [MMBTH10-TP](#) [BFP640F H6327](#) [BFR 360F H6765](#) [MRF10031](#) [NSVF4009SG4T1G](#) [BFP 182R E7764](#) [BFP405H6740XTSA1](#) [MRF10350](#) [ASMA201](#) [BFR360FH6765XTSA1](#) [BFP410H6327XTSA1](#) [BFP620FH7764XTSA1](#) [BFP720ESDH6327XTSA1](#) [BFP720FH6327XTSA1](#) [BFR360L3E6765XTMA1](#) [BFP420H6433XTMA1](#) [BFP420H6740XTSA1](#) [BFP420H6801XTSA1](#) [MCH4015-TL-H](#) [BF888H6327XTSA1](#) [MMBT2222A-G](#) [BFP196WH6327XTSA1](#) [BFP405FH6327XTSA1](#) [BFP640ESDH6327XTSA1](#) [BFR193L3E6327XTMA1](#) [BFS483H6327XTSA1](#) [NSVF4020SG4T1G](#) [NSVF6003SB6T1G](#) [MRF10005](#) [BFP420FH6327XTSA1](#) [BFP740FESDH6327XTSA1](#) [BFR181E6327HTSA1](#) [BFR181WH6327XTSA1](#) [BFR182E6327HTSA1](#) [BFR193E6327HTSA1](#) [BFP181E7764HTSA1](#) [BFP183WH6327XTSA1](#) [BFP720H6327XTSA1](#) [BFR182WH6327XTSA1](#) [BFU590GX](#) [MAPR-000912-500S00](#) [BFR340FH6327XTSA1](#) [STGWT30HP65FB](#)