

BFR340F

Low profile silicon NPN RF bipolar transistor



Product description

The BFR340F is a low noise device based on Si that is part of Infineon's established third generation RF bipolar transistor family. Its low current and high breakdown voltage characteristics make the device suitable for oscillators applications for frequencies as high as 3.5 GHz. It remains cost competitive without compromising on ease of use.



Feature list

- Minimum noise figure $NF_{min} = 1$ dB at 1.9 GHz, 1.5 V, 1 mA
- High gain $G_{ms} = 16.5$ dB at 1.8 GHz, 3 V, 5 mA
- $OIP_3 = 13$ dBm at 1.8 GHz, 3 V, 5 mA

Product validation

Qualified for industrial applications according to the relevant tests of JEDEC47/20/22.

Potential applications

- Low noise amplifiers (LNAs) for FM and AM radio
- LNAs for sub-1 GHz ISM band applications

Device information

Table 1 Part information

Product name / Ordering code	Package	Pin configuration			Marking	Pieces / Reel
BFR340F / BFR340FH6327XTSA1	TSFP-3-1	1 = B	2 = E	3 = C	FAs	3000

Attention: ESD (Electrostatic discharge) sensitive device, observe handling precautions

Table of contents

Table of contents

	Product description	1
	Feature list	1
	Product validation	1
	Potential applications	1
	Device information	1
	Table of contents	2
1	Absolute maximum ratings	3
2	Thermal characteristics	4
3	Electrical characteristics	5
3.1	DC characteristics	5
3.2	General AC characteristics	5
3.3	Frequency dependent AC characteristics	6
3.4	Characteristic AC diagrams	8
4	Package information TSFP-3-1	14
	Revision history	15
	Disclaimer	16

Absolute maximum ratings

1 Absolute maximum ratings

Table 2 Absolute maximum ratings at $T_A = 25\text{ °C}$ (unless otherwise specified)

Parameter	Symbol	Values		Unit	Note or test condition
		Min.	Max.		
Collector emitter voltage	V_{CEO}	-	6	V	Open base
Collector emitter voltage	V_{CES}		15		E-B short circuited
Collector base voltage	V_{CBO}		15		Open emitter
Emitter base voltage	V_{EBO}		2		Open collector
Base current	I_B		2	mA	-
Collector current	I_C		20		
Total power dissipation ¹⁾	P_{tot}		75	mW	$T_S \leq 110\text{ °C}$
Junction temperature	T_J		150	°C	-
Storage temperature	T_{Stg}	-55			

Attention: *Stresses above the max. values listed here may cause permanent damage to the device. Exposure to absolute maximum rating conditions for extended periods may affect device reliability. Exceeding only one of these values may cause irreversible damage to the integrated circuit.*

¹ T_S is the soldering point temperature. T_S is measured on the emitter lead at the soldering point of the PCB.

Thermal characteristics

2 Thermal characteristics

Table 3 Thermal resistance

Parameter	Symbol	Values			Unit	Note or test condition
		Min.	Typ.	Max.		
Junction - soldering point	R_{thJS}	-	530	-	K/W	-

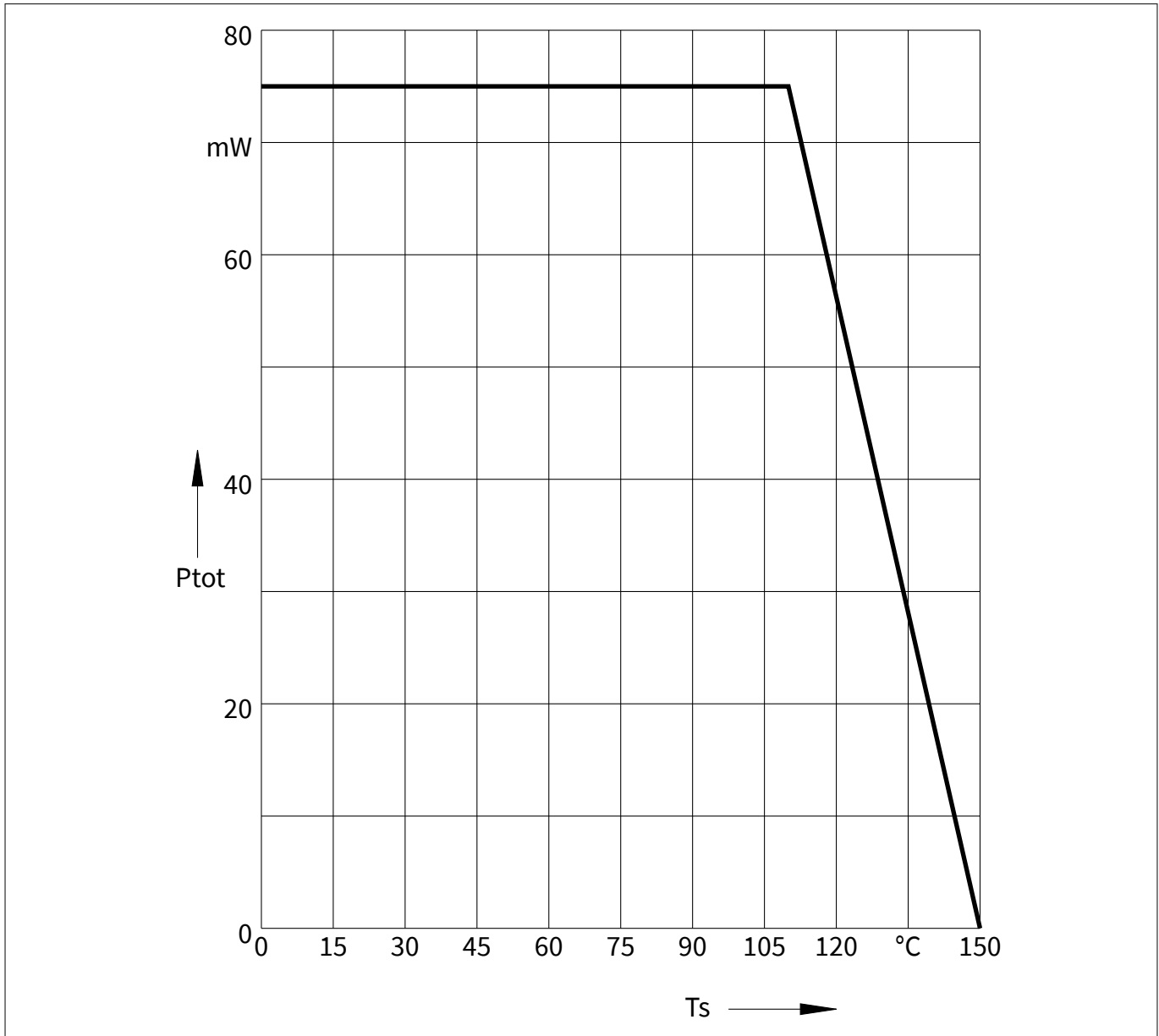

Figure 1 Total power dissipation $P_{tot} = f(T_s)$

Electrical characteristics

3 Electrical characteristics

3.1 DC characteristics

Table 4 DC characteristics at $T_A = 25\text{ °C}$ (unless otherwise specified)

Parameter	Symbol	Values			Unit	Note or test condition
		Min.	Typ.	Max.		
Collector emitter breakdown voltage	$V_{(BR)CEO}$	6	9	–	V	$I_C = 1\text{ mA}$, $I_B = 0$, open base
Collector emitter leakage current	I_{CES}	–	1	30 ²⁾	nA	$V_{CE} = 4\text{ V}$, $V_{BE} = 0$, E-B short circuited
			2	50 ²⁾		$V_{CE} = 10\text{ V}$, $V_{BE} = 0$, $T_A = 85\text{ °C}$, E-B short circuited
Collector base leakage current	I_{CBO}		1	30 ²⁾		$V_{CB} = 4\text{ V}$, $I_E = 0$, open emitter
Emitter base leakage current	I_{EBO}		1	500 ²⁾		$V_{EB} = 1\text{ V}$, $I_C = 0$, open collector
DC current gain	h_{FE}	90	120	160		$V_{CE} = 3\text{ V}$, $I_C = 5\text{ mA}$, pulse measured

3.2 General AC characteristics

Table 5 General AC characteristics at $T_A = 25\text{ °C}$

Parameter	Symbol	Values			Unit	Note or test condition
		Min.	Typ.	Max.		
Transition frequency	f_T	11	14	–	GHz	$V_{CE} = 3\text{ V}$, $I_C = 6\text{ mA}$, $f = 1\text{ GHz}$
Collector base capacitance	C_{CB}	–	0.21	0.4	pF	$V_{CB} = 5\text{ V}$, $V_{BE} = 0$, $f = 1\text{ MHz}$, emitter grounded
Collector emitter capacitance	C_{CE}		0.17	–		$V_{CE} = 5\text{ V}$, $V_{BE} = 0$, $f = 1\text{ MHz}$, base grounded
Emitter base capacitance	C_{EB}		0.11			$V_{EB} = 0.5\text{ V}$, $V_{CB} = 0$, $f = 1\text{ MHz}$, collector grounded

² Maximum values not limited by the device but by the short cycle time of the 100% test.

Electrical characteristics

3.3 Frequency dependent AC characteristics

Measurement setup is a test fixture with Bias-T's in a 50 Ω system, $T_A = 25\text{ °C}$.

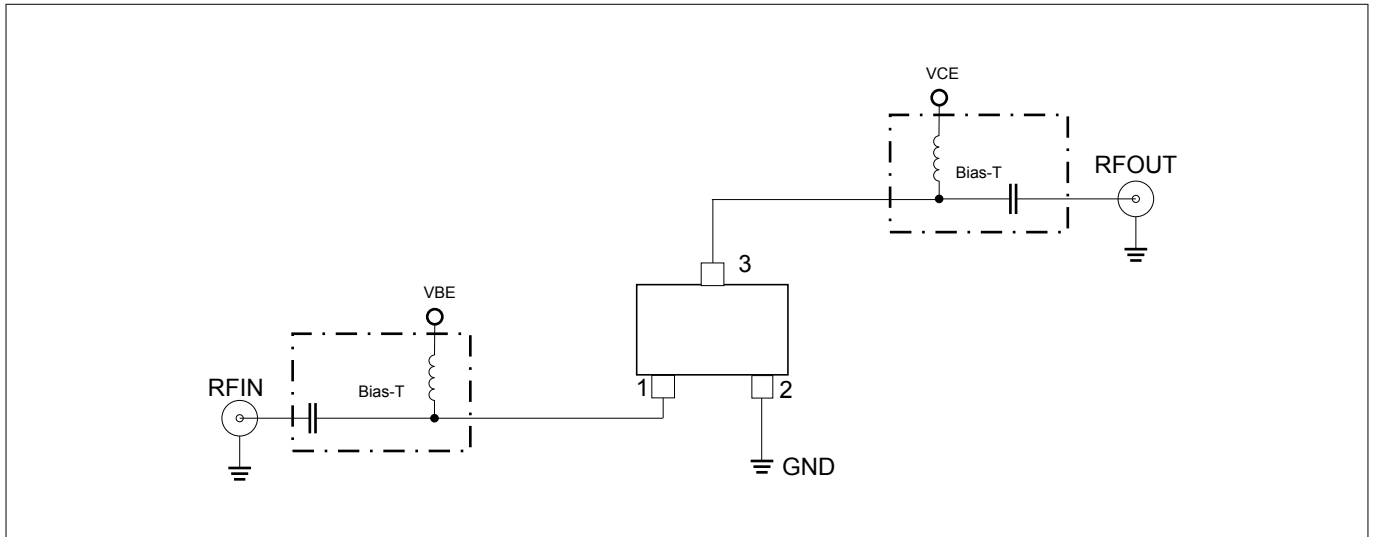

Figure 2 Testing circuit

Table 6 AC characteristics, $f = 100\text{ MHz}$

Parameter	Symbol	Values			Unit	Note or test condition
		Min.	Typ.	Max.		
Power gain		-		-	dB	$I_C = 3\text{ mA}, V_{CE} = 1.5\text{ V}$
<ul style="list-style-type: none"> Maximum power gain Transducer gain 	G_{ms} $ S_{21} ^2$		28 19			
Noise figure						$I_C = 3\text{ mA}, V_{CE} = 1.5\text{ V}$
<ul style="list-style-type: none"> Minimum noise figure 	NF_{min}		0.9			
Linearity					dBm	$I_C = 5\text{ mA}, V_{CE} = 3\text{ V}, Z_S = Z_L = 50\text{ }\Omega$
<ul style="list-style-type: none"> 3rd order intercept point at output 1 dB gain compression point at output 	OIP_3 OP_{1dB}		14 -3			

Table 7 AC characteristics, $V_{CE} = 3\text{ V}, f = 1.8\text{ GHz}$

Parameter	Symbol	Values			Unit	Note or test condition
		Min.	Typ.	Max.		
Power gain		-		-	dB	$I_C = 5\text{ mA}$
<ul style="list-style-type: none"> Maximum power gain Transducer gain 	G_{ms} $ S_{21} ^2$		16.5 14			
Linearity					dBm	$I_C = 5\text{ mA}, Z_S = Z_L = 50\text{ }\Omega$
<ul style="list-style-type: none"> 3rd order intercept point at output 1 dB gain compression point at output 	OIP_3 OP_{1dB}		13 -1			

Electrical characteristics

Table 8 AC characteristics, $f = 1.9$ GHz

Parameter	Symbol	Values			Unit	Note or test condition
		Min.	Typ.	Max.		
Power gain	G_{ms} $ S_{21} ^2$	-	16.3	-	dB	$I_C = 5$ mA, $V_{CE} = 3$ V
<ul style="list-style-type: none"> Maximum power gain Transducer gain 			13.4			
Noise figure	NF_{min}	-	1	-	dB	$I_C = 1$ mA, $V_{CE} = 1.5$ V
<ul style="list-style-type: none"> Minimum noise figure 						

Table 9 AC characteristics, $f = 2.4$ GHz

Parameter	Symbol	Values			Unit	Note or test condition
		Min.	Typ.	Max.		
Power gain	G_{ms} $ S_{21} ^2$	-	14.9	-	dB	$I_C = 5$ mA, $V_{CE} = 3$ V
<ul style="list-style-type: none"> Maximum power gain Transducer gain 			11.6			
Noise figure	NF_{min}	-	1.2	-	dB	$I_C = 1$ mA, $V_{CE} = 1.5$ V
<ul style="list-style-type: none"> Minimum noise figure 						

Table 10 AC characteristics, $V_{CE} = 3$ V, $f = 3$ GHz

Parameter	Symbol	Values			Unit	Note or test condition
		Min.	Typ.	Max.		
Power gain	G_{ms} $ S_{21} ^2$	-	13	-	dB	$I_C = 5$ mA
<ul style="list-style-type: none"> Maximum power gain Transducer gain 			10			

Note: $G_{ms} = |S_{21}/S_{12}|$ for $k < 1$; $G_{ma} = |S_{21}/S_{12}|(k-(k^2-1)^{1/2})$ for $k > 1$. In order to get the NF_{min} values stated in this chapter, the test fixture losses have been subtracted from all measured results. OIP_3 value depends on termination of all intermodulation frequency components. Termination used for this measurement is 50Ω from 0.1 MHz to 6 GHz.

Electrical characteristics

3.4 Characteristic AC diagrams

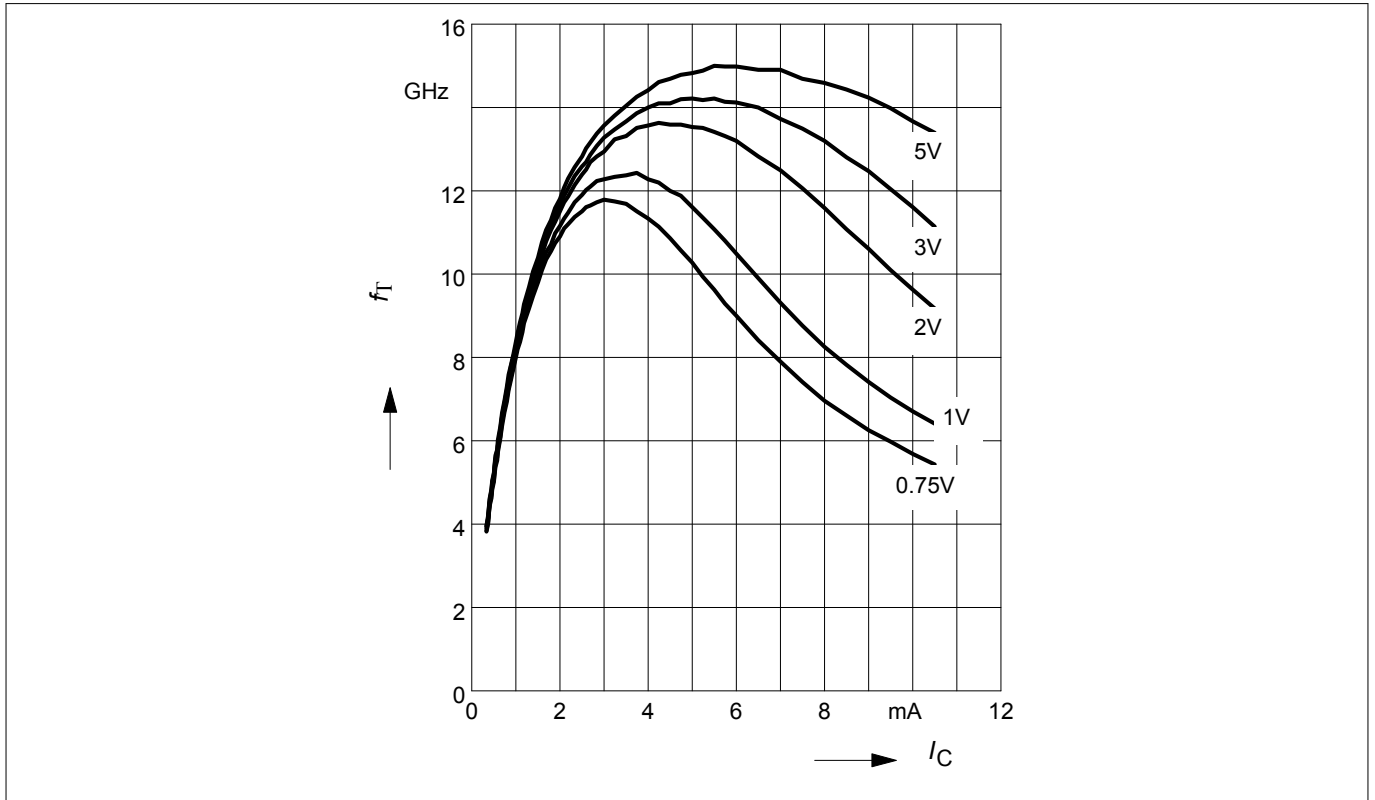

Figure 3 Transition frequency $f_T = f(I_C)$, $f = 1 \text{ GHz}$, $V_{CE} = \text{parameter}$

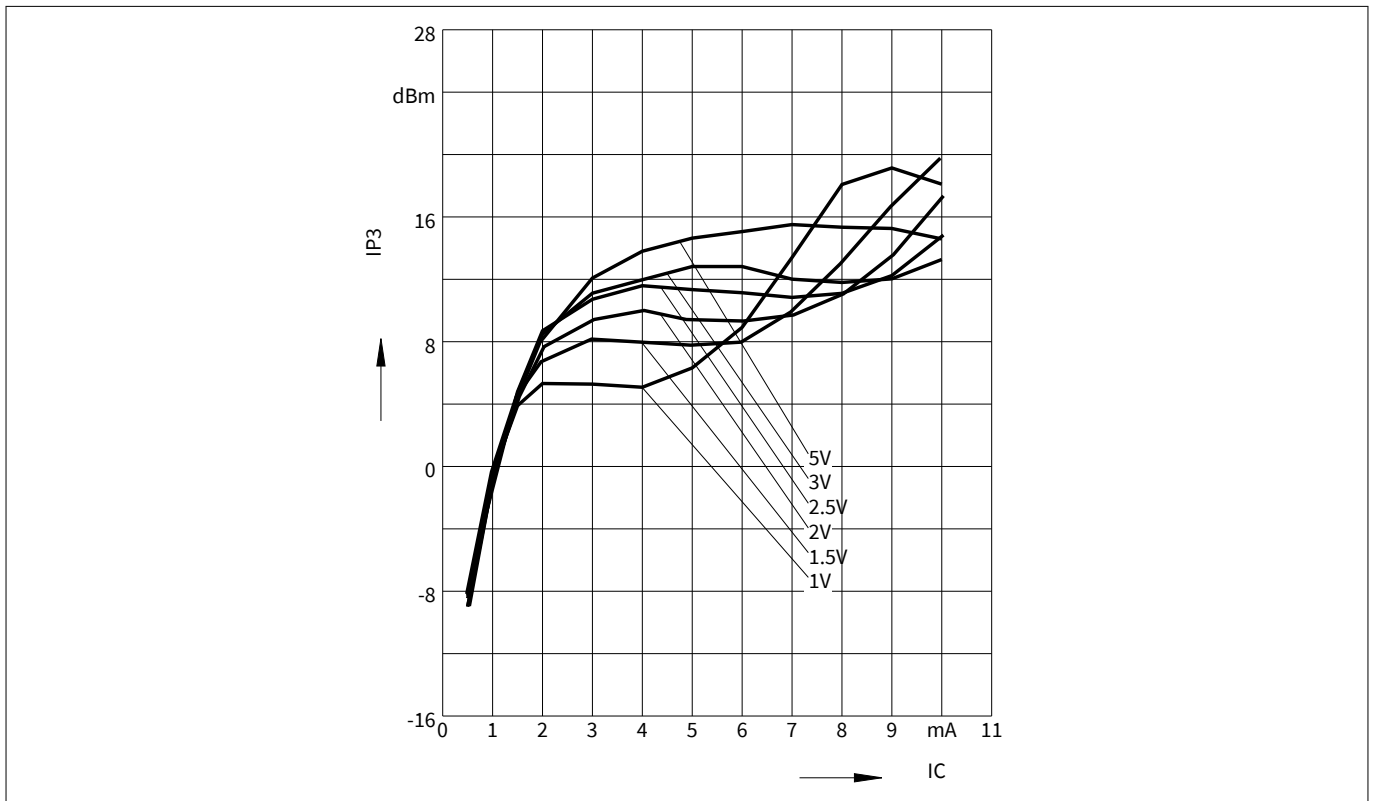

Figure 4 3rd order intercept point $OIP_3 = f(I_C)$, $Z_S = Z_L = 50 \Omega$, $f = 1.9 \text{ GHz}$, $V_{CE} = \text{parameter}$

Electrical characteristics

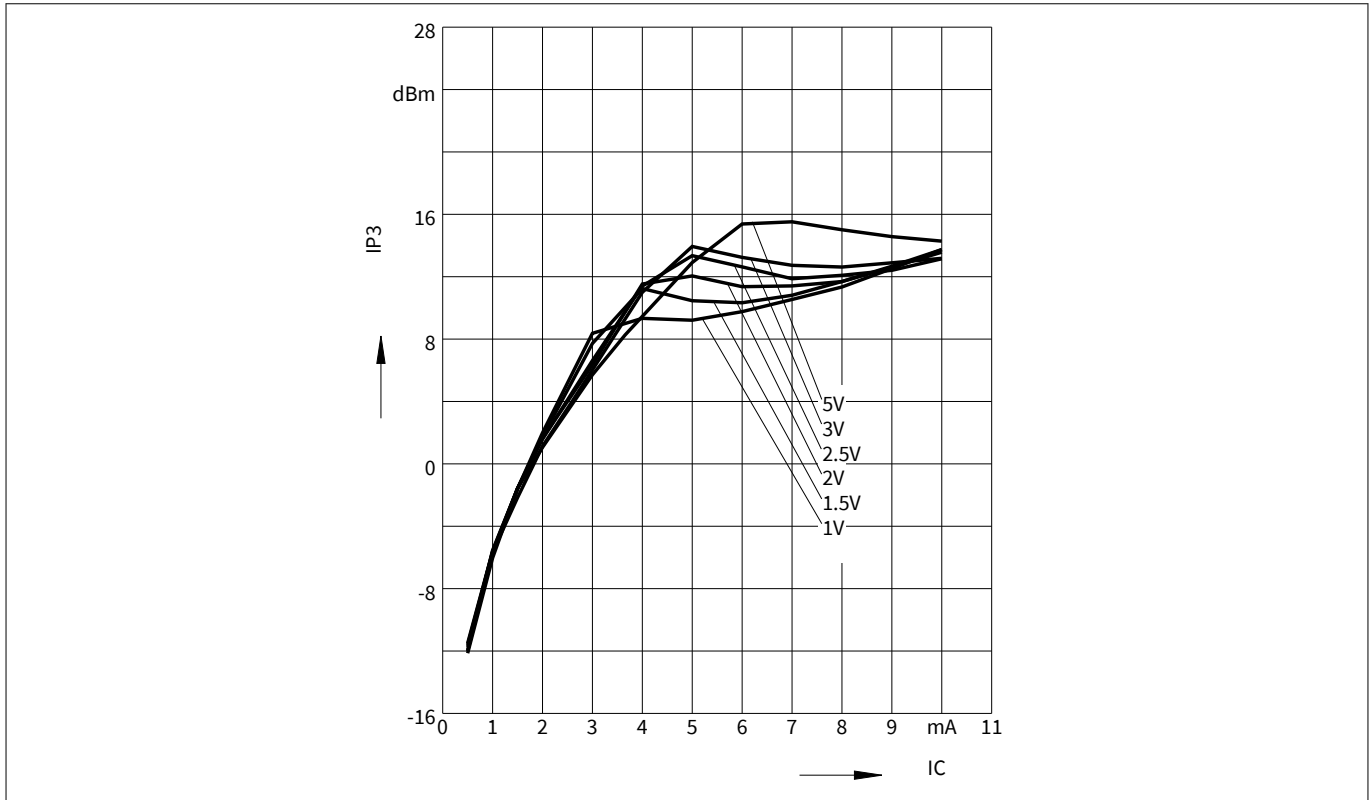

Figure 5 3rd order intercept point $OIP_3 = f(I_C, V_{CE}), Z_S = Z_L = 50 \Omega, f = 100 \text{ MHz}$

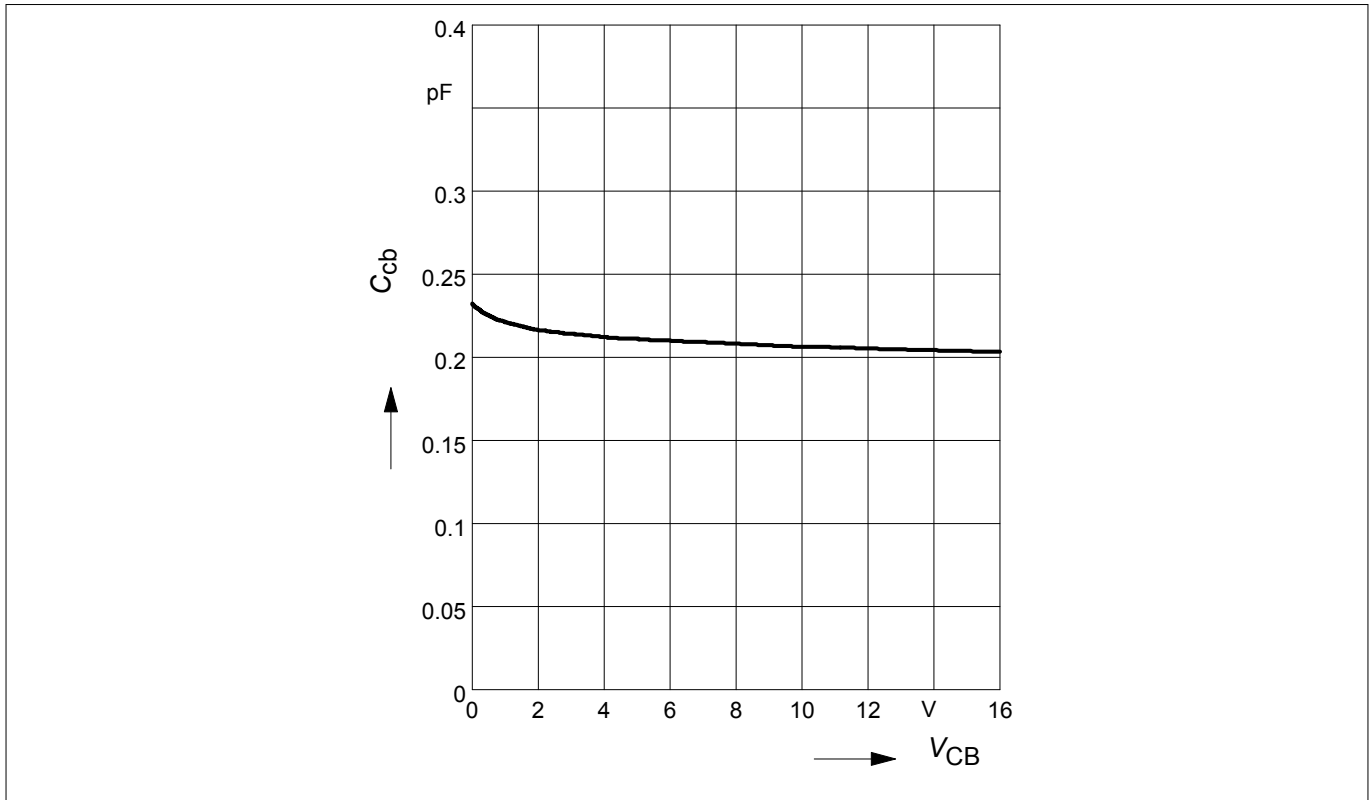

Figure 6 Collector base capacitance $C_{CB} = f(V_{CB}), f = 1 \text{ MHz}$

Electrical characteristics

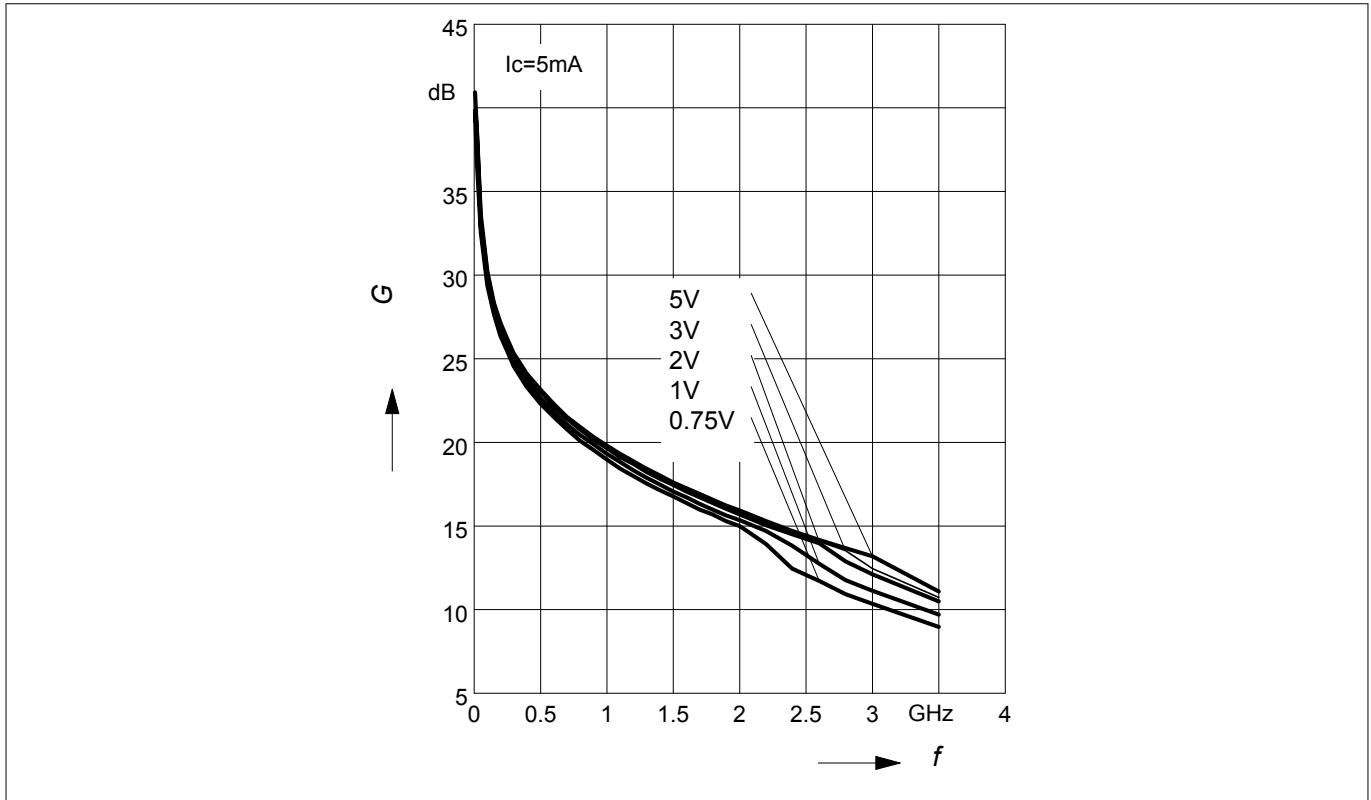

Figure 7 Gain $G_{ma}, G_{ms} = f(f), I_C = 5 \text{ mA}, V_{CE} = \text{parameter}$

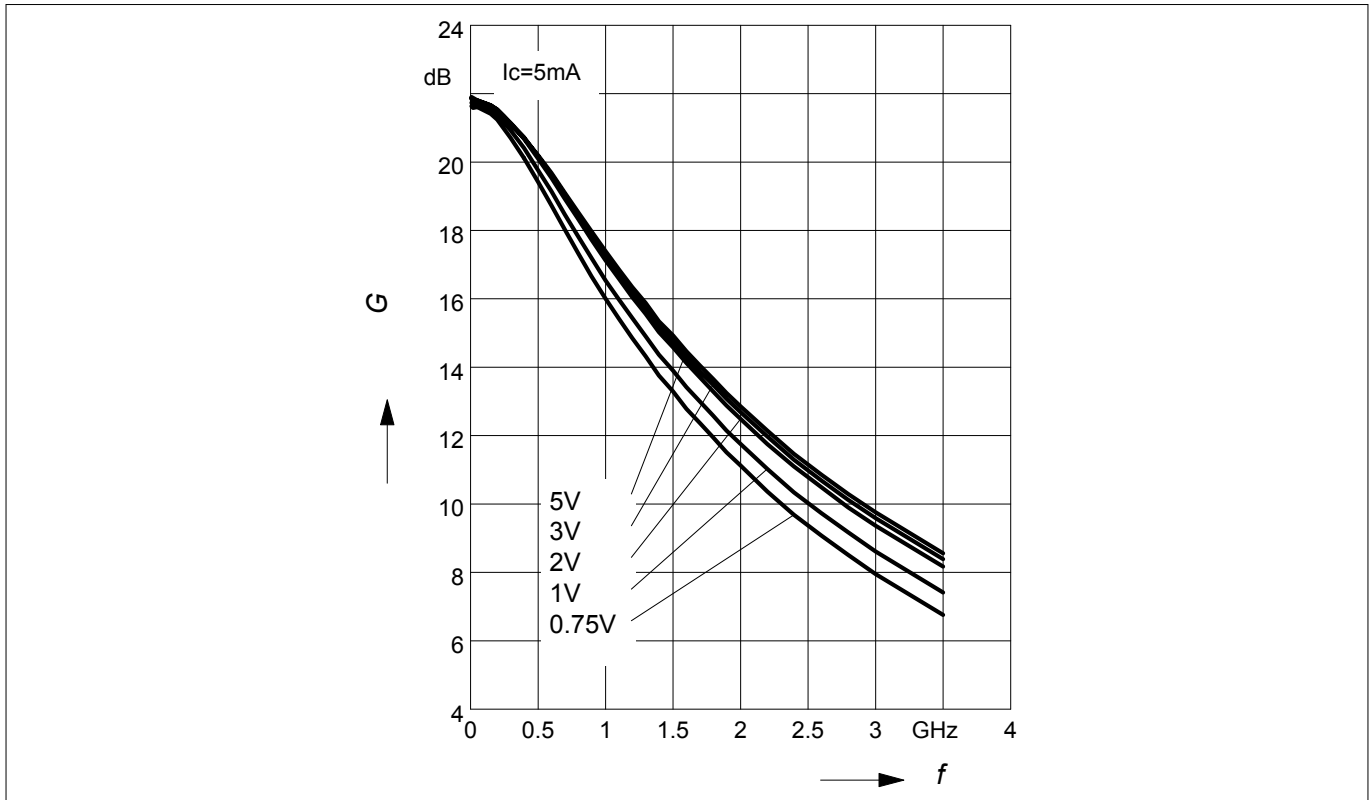

Figure 8 Transducer gain $IS_{21}^2 = f(f), I_C = 5 \text{ mA}, V_{CE} = \text{parameter}$

Electrical characteristics

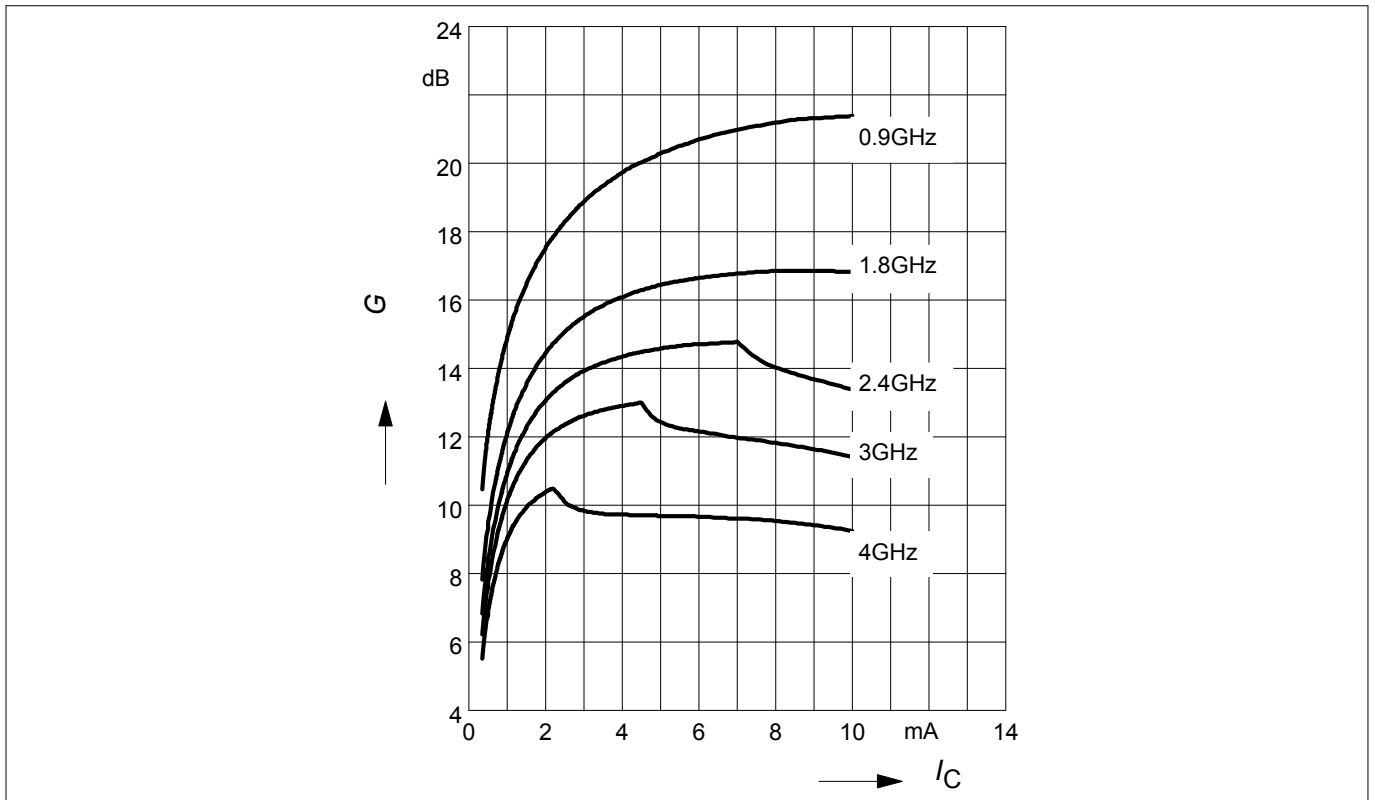

Figure 9 Maximum power gain $G_{max} = f(I_C)$, $V_{CE} = 3\text{ V}$, $f = \text{parameter}$

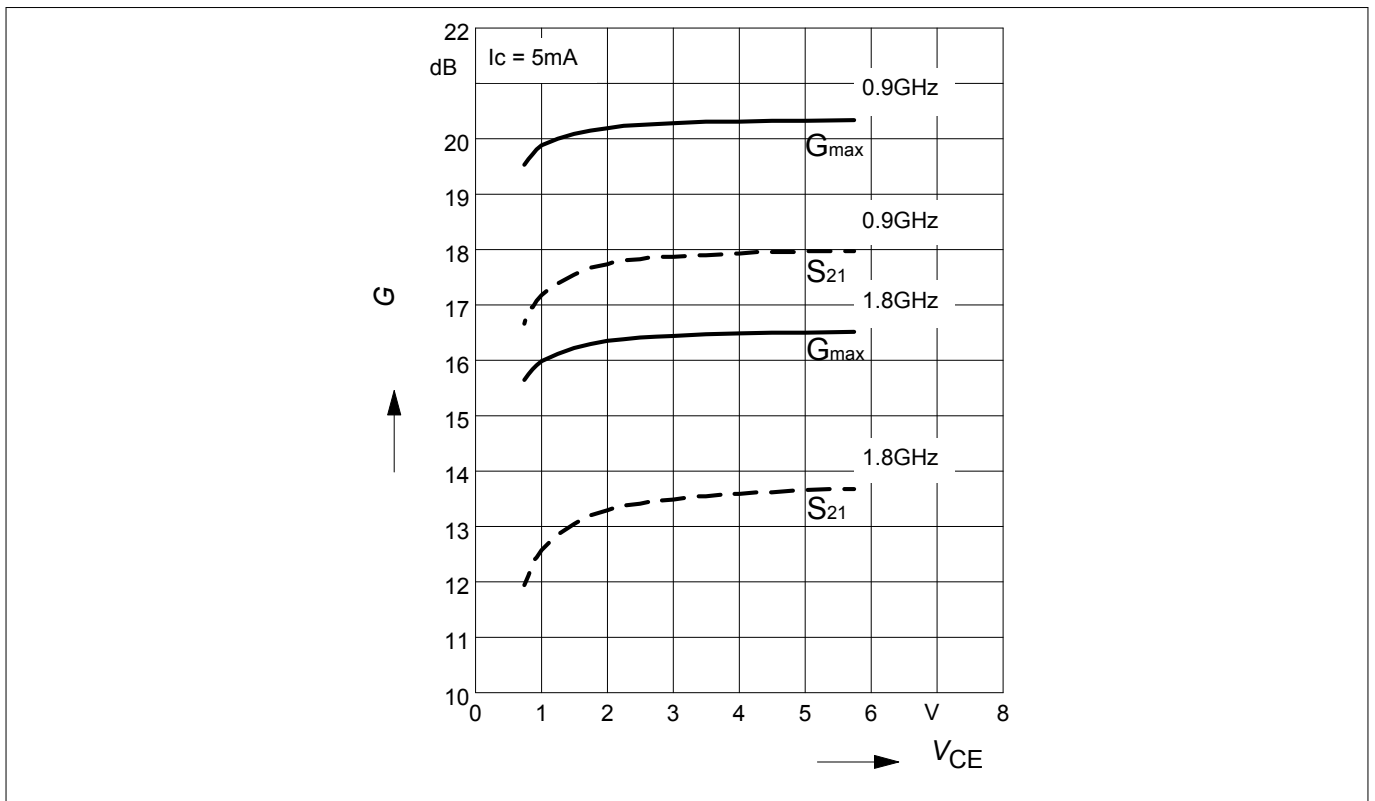

Figure 10 Maximum power gain $G_{max} = f(V_{CE})$, transducer gain $|S_{21}|^2 = f(V_{CE})$, $I_C = 5\text{ mA}$, $f = \text{parameter in GHz}$

Electrical characteristics

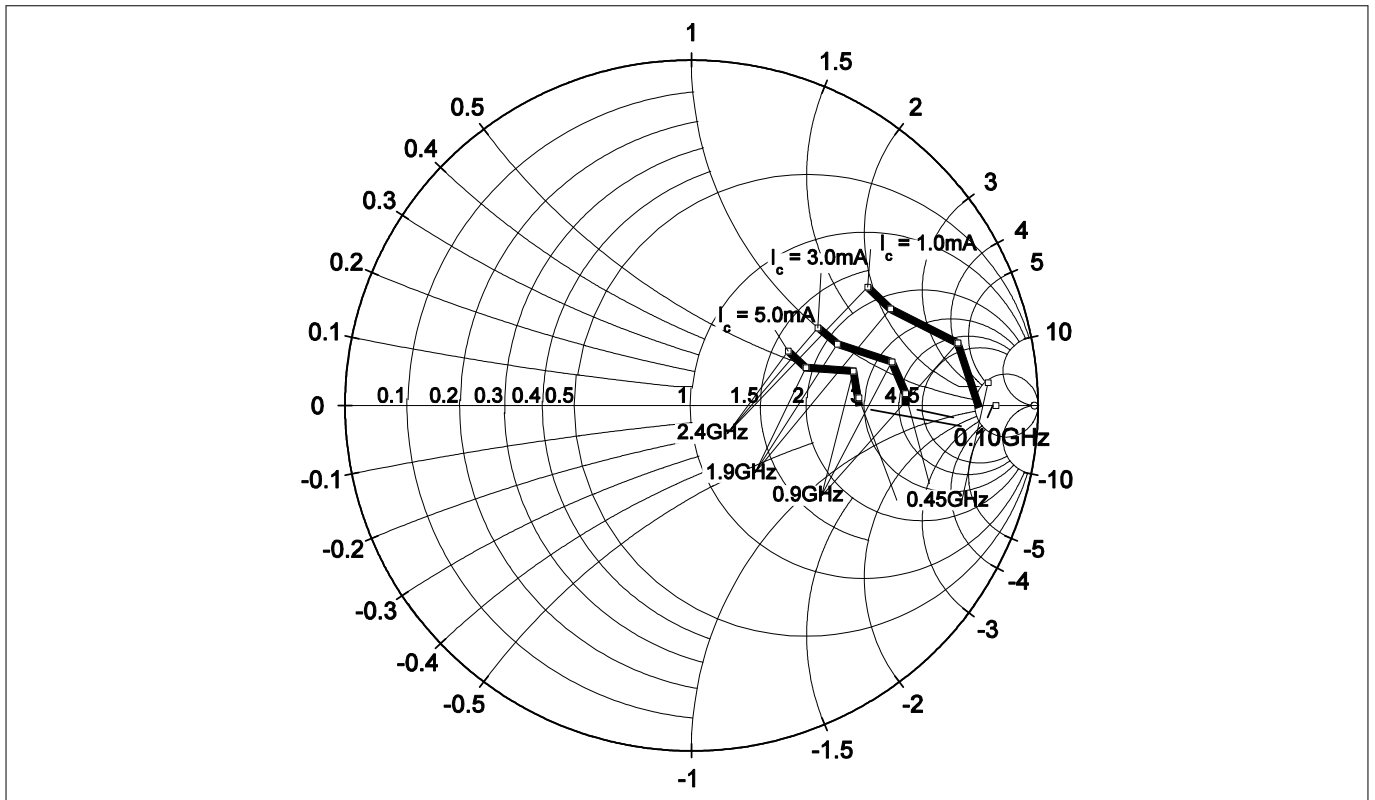

Figure 11 Source impedance for minimum noise figure $Z_{S,opt} = f(f)$, $V_{CE} = 1.5\text{ V}$, $I_C = \text{parameter}$

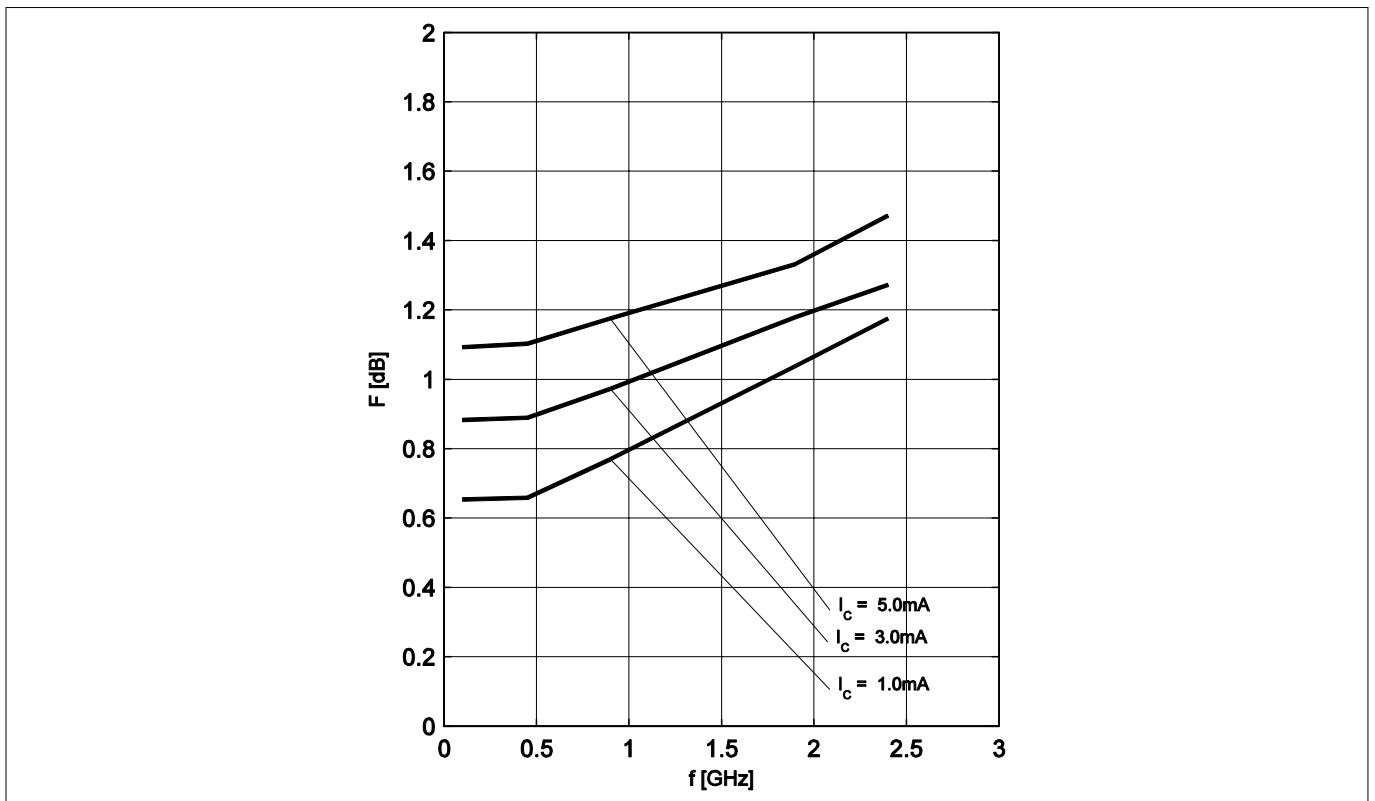

Figure 12 Noise figure $NF_{min} = f(f)$, $V_{CE} = 1.5\text{ V}$, $Z_S = Z_{S,opt}$, $I_C = 1 / 3 / 5\text{ mA}$

Electrical characteristics

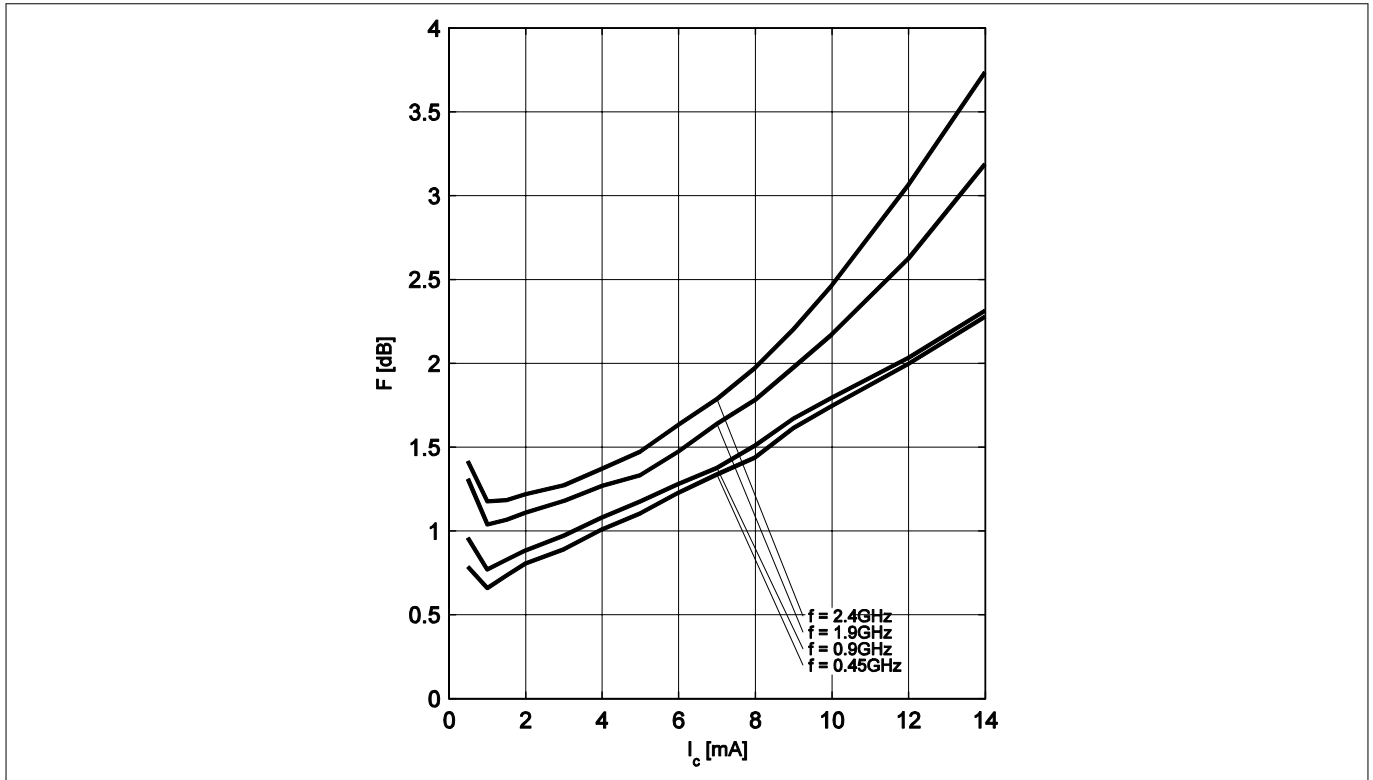

Figure 13 Noise figure $NF_{min} = f(I_C)$, $V_{CE} = 1.5\text{ V}$, $Z_S = Z_{S,opt}$, $f = \text{parameter in GHz}$

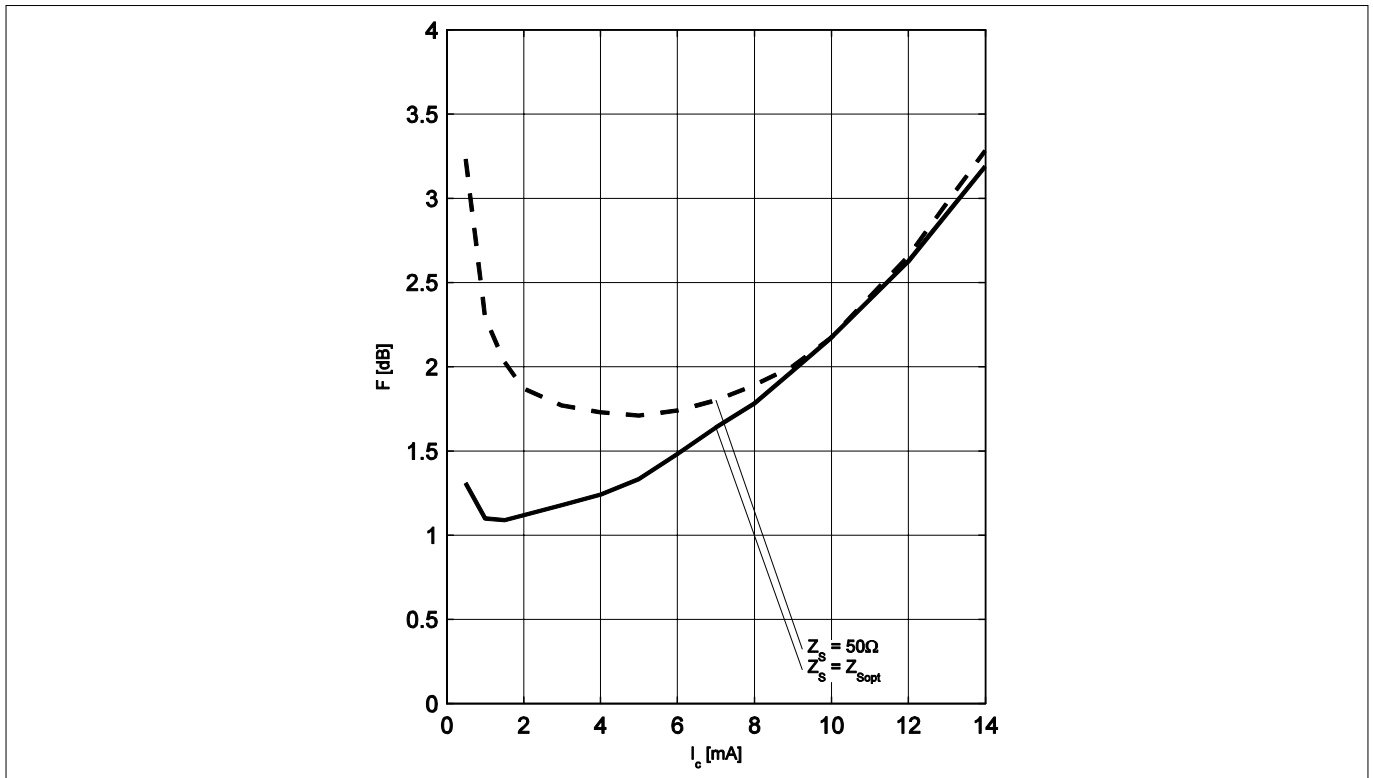

Figure 14 Noise figure $NF_{min} = f(I_C)$, $Z_S = Z_{S,opt}$, $NF_{50} = f(I_C)$, $Z_S = 50\ \Omega$, $V_{CE} = 3\text{ V}$, $f = 1.9\text{ GHz}$

Note: The curves shown in this chapter have been generated using typical devices but shall not be considered as a guarantee that all devices have identical characteristic curves. $T_A = 25\text{ }^\circ\text{C}$.

Package information TSFP-3-1

4 Package information TSFP-3-1

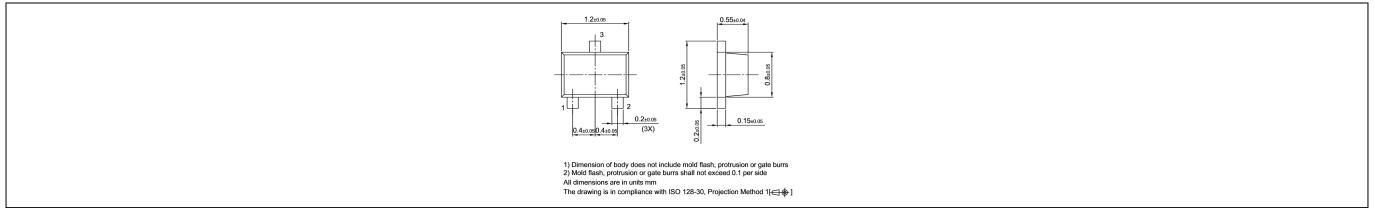

Figure 15 Package outline

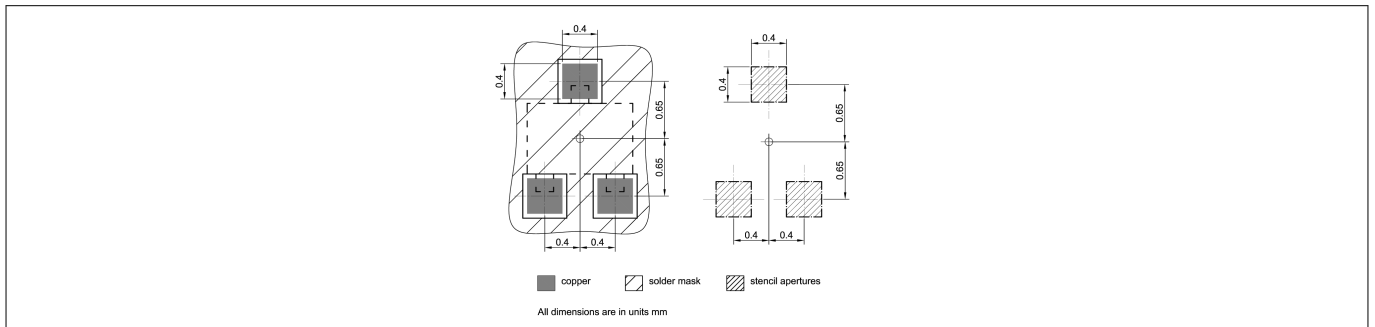

Figure 16 Foot print

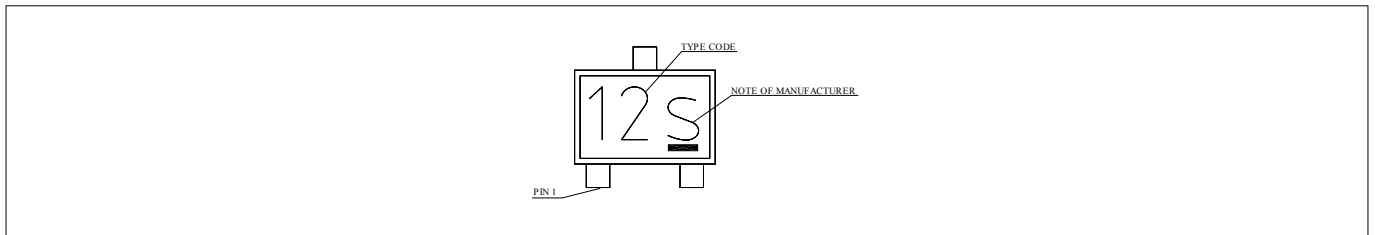

Figure 17 Marking layout example

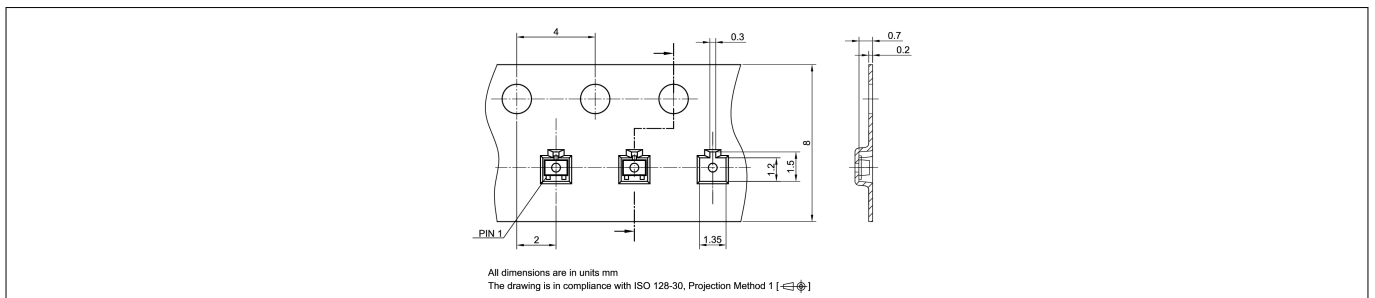

Figure 18 Tape information

Revision history

Revision history

Document version	Date of release	Description of changes
Revision 2.0	2019-01-25	New datasheet layout.

Trademarks

All referenced product or service names and trademarks are the property of their respective owners.

Edition 2019-01-25

Published by
Infineon Technologies AG
81726 Munich, Germany

© 2019 Infineon Technologies AG
All Rights Reserved.

Do you have a question about any
aspect of this document?
Email: erratum@infineon.com

Document reference
IFX-pky1525443005897

IMPORTANT NOTICE

The information given in this document shall in no event be regarded as a guarantee of conditions or characteristics ("Beschaffheitsgarantie").

With respect to any examples, hints or any typical values stated herein and/or any information regarding the application of the product, Infineon Technologies hereby disclaims any and all warranties and liabilities of any kind, including without limitation warranties of non-infringement of intellectual property rights of any third party.

In addition, any information given in this document is subject to customer's compliance with its obligations stated in this document and any applicable legal requirements, norms and standards concerning customer's products and any use of the product of Infineon Technologies in customer's applications.

The data contained in this document is exclusively intended for technically trained staff. It is the responsibility of customer's technical departments to evaluate the suitability of the product for the intended application and the completeness of the product information given in this document with respect to such application.

WARNINGS

Due to technical requirements products may contain dangerous substances. For information on the types in question please contact your nearest Infineon Technologies office.

Except as otherwise explicitly approved by Infineon Technologies in a written document signed by authorized representatives of Infineon Technologies, Infineon Technologies' products may not be used in any applications where a failure of the product or any consequences of the use thereof can reasonably be expected to result in personal injury

X-ON Electronics

Largest Supplier of Electrical and Electronic Components

Click to view similar products for [RF Bipolar Transistors](#) category:

Click to view products by [Infineon](#) manufacturer:

Other Similar products are found below :

[MAPRST0912-50](#) [MCH4016-TL-H](#) [MMBT5551-G](#) [MRF10120](#) [15GN01CA-TB-E](#) [PH1214-25M](#) [MAPRST0912-350](#) [MMBTH10-TP](#) [BFP640F H6327](#) [BFP 720F H6327](#) [BFP 740F H6327](#) [BFR 360F H6765](#) [MRF10031](#) [NSVF4009SG4T1G](#) [BFP 182R E7764](#) [BFP405H6740XTSA1](#) [MRF10350](#) [ASMA201](#) [BFR360FH6765XTSA1](#) [BFP410H6327XTSA1](#) [BFP620FH7764XTSA1](#) [BFP720ESDH6327XTSA1](#) [BFP720FH6327XTSA1](#) [BFR360L3E6765XTMA1](#) [BFP420H6433XTMA1](#) [BFP420H6740XTSA1](#) [MCH4015-TL-H](#) [BF888H6327XTSA1](#) [MMBT2222A-G](#) [BFP196WH6327XTSA1](#) [BFP405FH6327XTSA1](#) [BFP640ESDH6327XTSA1](#) [BFR193L3E6327XTMA1](#) [BFS483H6327XTSA1](#) [NSVF4020SG4T1G](#) [NSVF6003SB6T1G](#) [MRF10005](#) [BFP420FH6327XTSA1](#) [BFP740FESDH6327XTSA1](#) [BFR181E6327HTSA1](#) [BFR181WH6327XTSA1](#) [BFR182E6327HTSA1](#) [BFR193E6327HTSA1](#) [BFP181E7764HTSA1](#) [BFP183WH6327XTSA1](#) [BFP720H6327XTSA1](#) [BFR182WH6327XTSA1](#) [BFU590GX](#) [MAPR-000912-500S00](#) [BFR340FH6327XTSA1](#)