

BGA777N7

Single-Band UMTS LNA (2300 - 2700 MHz)

Data Sheet

Revision 3.1, 2013-01-31

Edition 2013-01-31

**Published by
Infineon Technologies AG
81726 Munich, Germany**

**© 2013 Infineon Technologies AG
All Rights Reserved.**

Legal Disclaimer

The information given in this document shall in no event be regarded as a guarantee of conditions or characteristics. With respect to any examples or hints given herein, any typical values stated herein and/or any information regarding the application of the device, Infineon Technologies hereby disclaims any and all warranties and liabilities of any kind, including without limitation, warranties of non-infringement of intellectual property rights of any third party.

Information

For further information on technology, delivery terms and conditions and prices, please contact the nearest Infineon Technologies Office (www.infineon.com).

Warnings

Due to technical requirements, components may contain dangerous substances. For information on the types in question, please contact the nearest Infineon Technologies Office.

Infineon Technologies components may be used in life-support devices or systems only with the express written approval of Infineon Technologies, if a failure of such components can reasonably be expected to cause the failure of that life-support device or system or to affect the safety or effectiveness of that device or system. Life support devices or systems are intended to be implanted in the human body or to support and/or maintain and sustain and/or protect human life. If they fail, it is reasonable to assume that the health of the user or other persons may be endangered.

BGA777N7 Single-Band UMTS LNA (2300 - 2700 MHz)

Revision History: 2013-01-31, Revision 3.1

Previous Revision: 2012-10-31, Revision 3.0

Page	Subjects (major changes since last revision)
33	Footprint recommendation drawing added
34	Marking pattern drawing updated

Trademarks of Infineon Technologies AG

AURIX™, C166™, CanPAK™, CIPOS™, CIPURSET™, EconoPACK™, CoolMOS™, CoolSET™, CORECONTROL™, CROSSAVE™, DAVE™, DI-POL™, EasyPIM™, EconoBRIDGE™, EconoDUAL™, EconoPIM™, EconoPACK™, EiceDRIVER™, eupec™, FCOS™, HITFET™, HybridPACK™, I²RF™, ISOFACE™, IsoPACK™, MIPAQ™, ModSTACK™, my-d™, NovalithIC™, OptiMOS™, ORIGA™, POWERCODE™, PRIMARION™, PrimePACK™, PrimeSTACK™, PRO-SIL™, PROFET™, RASIC™, ReverSave™, SatRIC™, SIEGET™, SINDRION™, SIPMOS™, SmartLEWIS™, SOLID FLASH™, TEMPFET™, thinQ!™, TRENCHSTOP™, TriCore™.

Other Trademarks

Advance Design System™ (ADS) of Agilent Technologies, AMBA™, ARM™, MULTI-ICET™, KEIL™, PRIMECELL™, REALVIEW™, THUMB™, μVision™ of ARM Limited, UK. AUTOSAR™ is licensed by AUTOSAR development partnership. Bluetooth™ of Bluetooth SIG Inc. CAT-iq™ of DECT Forum. COLOSSUS™, FirstGPS™ of Trimble Navigation Ltd. EMV™ of EMVCo, LLC (Visa Holdings Inc.). EPCOS™ of Epcos AG. FLEXGO™ of Microsoft Corporation. FlexRay™ is licensed by FlexRay Consortium. HYPERTERMINAL™ of Hilgraeve Incorporated. IEC™ of Commission Electrotechnique Internationale. IrDA™ of Infrared Data Association Corporation. ISO™ of INTERNATIONAL ORGANIZATION FOR STANDARDIZATION. MATLAB™ of MathWorks, Inc. MAXIM™ of Maxim Integrated Products, Inc. MICROTEC™, NUCLEUS™ of Mentor Graphics Corporation. MIPI™ of MIPI Alliance, Inc. MIPS™ of MIPS Technologies, Inc., USA. muRata™ of MURATA MANUFACTURING CO., MICROWAVE OFFICE™ (MWO) of Applied Wave Research Inc., OmniVision™ of OmniVision Technologies, Inc. Openwave™ Openwave Systems Inc. RED HAT™ Red Hat, Inc. RFMD™ RF Micro Devices, Inc. SIRIUS™ of Sirius Satellite Radio Inc. SOLARIS™ of Sun Microsystems, Inc. SPANSION™ of Spansion LLC Ltd. Symbian™ of Symbian Software Limited. TAIYO YUDEN™ of Taiyo Yuden Co. TEAKLITE™ of CEVA, Inc. TEKTRONIX™ of Tektronix Inc. TOKO™ of TOKO KABUSHIKI KAISHA TA. UNIX™ of X/Open Company Limited. VERILOG™, PALLADIUM™ of Cadence Design Systems, Inc. VLYNQ™ of Texas Instruments Incorporated. VXWORKS™, WIND RIVER™ of WIND RIVER SYSTEMS, INC. ZETEX™ of Diodes Zetex Limited.

Last Trademarks Update 2011-11-11

Table of Contents

	Table of Contents	4
	List of Figures	5
	List of Tables	6
1	Features	7
2	Electrical Characteristics	9
2.1	Absolute Maximum Ratings	9
2.2	Thermal Resistance	9
2.3	ESD Integrity	9
2.4	DC Characteristics	10
2.5	Gain Mode Select Truth Table	10
2.6	Switching Times	10
2.7	Supply Current Characteristics	11
2.8	Logic Signal Characteristics	12
2.9	Measured RF Characteristics UMTS Band 7	13
2.10	Measured RF Characteristics UMTS Band 7	14
2.11	Measured RF Characteristics UMTS Band 7	15
2.12	Measured RF Characteristics UMTS Band 38	16
2.13	Measured RF Characteristics UMTS Band 38	17
2.14	Measured RF Characteristics UMTS Band 38	18
2.15	Measured RF Characteristics UMTS Band 40	19
2.16	Measured RF Characteristics UMTS Band 40	20
2.17	Measured RF Characteristics UMTS Band 40	21
2.18	Measured Performance Band 7 Application High Gain Mode vs. Frequency	22
2.19	Measured Performance Band 7 Application High Gain Mode vs. Temperature	24
2.20	Measured Performance Band 7 Application Low Gain Mode vs. Frequency	25
2.21	Measured Performance Band 7 Application Low Gain Mode vs. Temperature	27
3	Application Circuit and Block Diagram	28
3.1	UMTS Band 7 Application Circuit Schematic	28
3.2	UMTS Band 38 Application Circuit Schematic	29
3.3	UMTS Band 40 Application Circuit Schematic	30
3.4	Pin Definition	30
3.5	Application Board	31
4	Physical Characteristics	33
4.1	Package Footprint	33
4.2	Package Dimensions	34
4.3	Product Marking Pattern	34

List of Figures

Figure 1	Block Diagram of Single-Band LNA	8
Figure 2	Application Circuit with Chip Outline (Top View)	28
Figure 3	Application Circuit with Chip Outline (Top View)	29
Figure 4	Application Circuit with Chip Outline (Top View)	30
Figure 5	Application Board Layout on 3-Layer FR4	31
Figure 6	Cross-Section View of Application Board	31
Figure 7	Detail of Application Board Layout	32
Figure 8	Footprint Recommendation 1 for the TSNP-7-1 Package	33
Figure 9	Footprint Recommendation 2 for the TSNP-7-1 Package	33
Figure 10	Package Outline (top, side and bottom view)	34
Figure 11	Tape & Reel Dimensions	34
Figure 12	Marking Pattern (top view)	34

List of Tables

Table 1	Absolute Maximum Ratings	9
Table 2	Thermal Resistance	9
Table 3	ESD Integrity	9
Table 4	DC Characteristics, $T_A = -30 \dots 85 \text{ }^\circ\text{C}$	10
Table 5	Truth Table	10
Table 6	Typical switching times; $T_A = -30 \dots 85 \text{ }^\circ\text{C}$	10
Table 7	Typical Characteristics 2650 MHz Band, $T_A = -30 \text{ }^\circ\text{C}$, $V_{CC} = 2.8 \text{ V}$	13
Table 8	Typical Characteristics 2650 MHz Band, $T_A = 25 \text{ }^\circ\text{C}$, $V_{CC} = 2.8 \text{ V}$	14
Table 9	Typical Characteristics 2650 MHz Band, $T_A = 85 \text{ }^\circ\text{C}$, $V_{CC} = 2.8 \text{ V}$	15
Table 10	Typical Characteristics 2600 MHz Band, $T_A = -30 \text{ }^\circ\text{C}$, $V_{CC} = 2.8 \text{ V}$	16
Table 11	Typical Characteristics 2600 MHz Band, $T_A = 25 \text{ }^\circ\text{C}$, $V_{CC} = 2.8 \text{ V}$	17
Table 12	Typical Characteristics 2600 MHz Band, $T_A = 85 \text{ }^\circ\text{C}$, $V_{CC} = 2.8 \text{ V}$	18
Table 13	Typical Characteristics 2300 MHz Band, $T_A = -30 \text{ }^\circ\text{C}$, $V_{CC} = 2.8 \text{ V}$	19
Table 14	Typical Characteristics 2300 MHz Band, $T_A = 25 \text{ }^\circ\text{C}$, $V_{CC} = 2.8 \text{ V}$	20
Table 15	Typical Characteristics 2300 MHz Band, $T_A = 85 \text{ }^\circ\text{C}$, $V_{CC} = 2.8 \text{ V}$	21
Table 16	Bill of Materials	28
Table 17	Bill of Materials	29
Table 18	Bill of Materials	30
Table 19	Pin Definition and Function	30

1 Features

Main features:

- Gain: 16 / -7 dB in high / low gain mode
- Noise figure: 1.2 dB in high gain mode
- Supply current: 4.2 / 0.5 mA in high / low gain mode
- Standby mode (< 2 μ A typ.)
- Output internally matched to 50 Ω
- Inputs pre-matched to 50 Ω
- 2 kV HBM ESD protection
- Low external component count
- Small leadless TSNP-7-1 package (2.0 x 1.3 x 0.39 mm)
- Pb-free (RoHS compliant) package



Description

The BGA777N7 is a low current single-band low noise amplifier MMIC for UMTS bands 7, 38 and 40. The LNA is based upon Infineon's proprietary and cost-effective SiGe:C technology and comes in a low profile TSNP-7-1 leadless green package. This document specifies electrical parameters, pinout, application circuit and packaging of the chip. The device features dynamic gain control, temperature stabilization, standby mode and 2 kV ESD protection on-chip as well as matching off chip.

Product Name	Package	Chip	Marking
BGA777N7	TSNP-7-1	T1531	B7

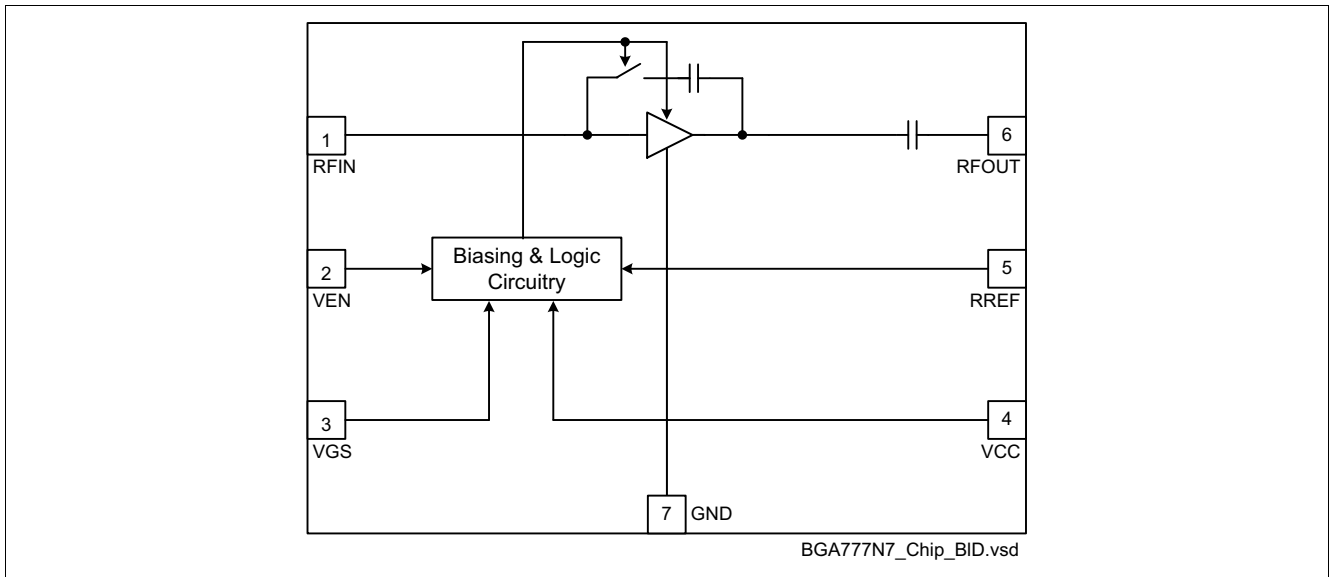

Figure 1 Block Diagram of Single-Band LNA

2 Electrical Characteristics

2.1 Absolute Maximum Ratings

Table 1 Absolute Maximum Ratings

Parameter	Symbol	Values			Unit	Note / Test Condition
		Min.	Typ.	Max.		
Supply voltage	V_{CC}	-0.3	–	3.6	V	–
Supply current	I_{CC}	–	–	10	mA	–
Pin voltage	V_{PIN}	-0.3	–	$V_{CC}+0.3$	V	All pins except RF input pins.
Pin voltage RF Input Pins	V_{RFIN}	-0.3	–	0.9	V	–
RF input power	P_{RFIN}	–	–	4	dBm	–
Junction temperature	T_j	–	–	150	°C	–
Ambient temperature range	T_A	-30	–	85	°C	–
Storage temperature range	T_{stg}	-65	–	150	°C	–

Attention: Stresses above the max. values listed here may cause permanent damage to the device. Exposure to absolute maximum rating conditions for extended periods may affect device reliability. Maximum ratings are absolute ratings; exceeding only one of these values may cause irreversible damage to the integrated circuit.

2.2 Thermal Resistance

Table 2 Thermal Resistance

Parameter	Symbol	Values			Unit	Note / Test Condition
		Min.	Typ.	Max.		
Thermal resistance junction to soldering point	R_{thJS}	–	240	–	K/W	–

2.3 ESD Integrity

Table 3 ESD Integrity

Parameter	Symbol	Values			Unit	Note / Test Condition
		Min.	Typ.	Max.		
ESD hardness HBM ¹⁾	$V_{ESD-HBM}$	–	2000	–	V	All pins

1) According to JESD22-A114

2.4 DC Characteristics

Table 4 DC Characteristics, $T_A = -30 \dots 85 \text{ }^\circ\text{C}$

Parameter	Symbol	Values			Unit	Note / Test Condition
		Min.	Typ.	Max.		
Supply voltage	V_{CC}	2.6	2.8	3.0	V	–
Supply current high gain mode	I_{CCHG}	2.8	4.2	5.8	mA	
Supply current low gain mode	I_{CCLG}	0.2	0.53	0.8	mA	
Supply current standby mode	I_{CCOFF}	-0.5	0.1	2.0	μA	–
Logic level high	V_{HI}	1.5	2.8	3.0	V	All logic pins
Logic level low	V_{LO}	-0.2	0.0	0.5	V	
Logic currents	I_{LO}	-0.5	0.01	2.0	μA	All logic pins
	I_{HI}	4.0	5.0	6.0	μA	

2.5 Gain Mode Select Truth Table

Table 5 Truth Table

Control Voltage		State	
		Bands 7, 38, 40	
VEN	VGS	HG	LG
H	L	OFF	ON
H	H	ON	OFF
L	L	STANDBY ¹⁾	
L	H		

1) In order to achieve minimum standby current it is encouraged to apply logic low-level at the VGS pin in standby mode although this is not mandatory. Details see section 2.4.

2.6 Switching Times

Table 6 Typical switching times; $T_A = -30 \dots 85 \text{ }^\circ\text{C}$

Parameter	Symbol	Values			Unit	Note / Test Condition
		Min.	Typ.	Max.		
Settling time gainstep	t_{GS}	–	1	5	μs	Switching LG \leftrightarrow HG

2.7 Supply Current Characteristics

Supply current high gain mode versus resistance of reference resistor R_{REF} (see Figure 2 on Page 28; low gain mode supply current is independent of reference resistor).

Supply Current $I_{CC} = f(R_{REF})$
 $V_{CC} = 2.8 \text{ V}$, $T_A = 25 \text{ }^\circ\text{C}$

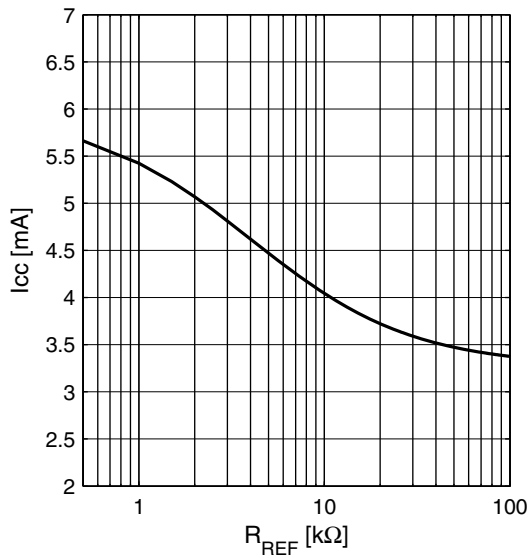

Power Gain $|S_{21}| = f(R_{REF})$
 $V_{CC} = 2.8 \text{ V}$, $T_A = 25 \text{ }^\circ\text{C}$

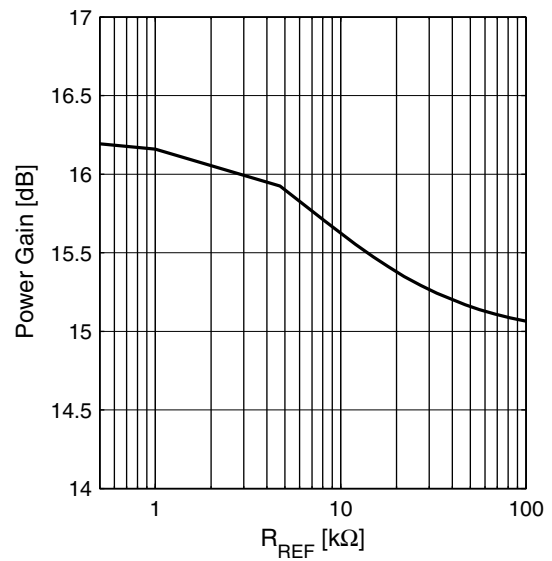

2.8 Logic Signal Characteristics

Current consumption of logic inputs VEN, VGS

Logic Current $I_{EN} = f(V_{EN})$
 $V_{CC} = 2.8 \text{ V}$, $T_A = 25 \text{ }^\circ\text{C}$

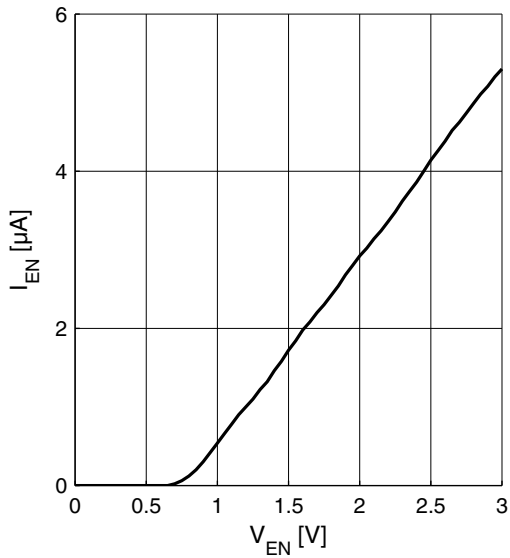

Logic Current $I_{GS} = f(V_{GS})$
 $V_{CC} = 2.8 \text{ V}$, $T_A = 25 \text{ }^\circ\text{C}$

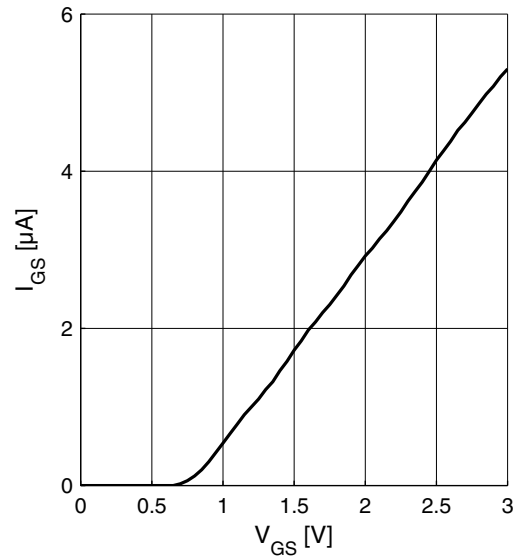

2.9 Measured RF Characteristics UMTS Band 7

Table 7 Typical Characteristics 2650 MHz Band, $T_A = -30\text{ °C}$, $V_{CC} = 2.8\text{ V}^{1)2)}$

Parameter	Symbol	Values			Unit	Note / Test Condition
		Min.	Typ.	Max.		
Pass band range band VII		2620	–	2690	MHz	–
Current consumption	I_{CCHG}	2.8	3.4	4.0	mA	High gain mode
	I_{CCLG}	0.2	0.5	0.8	mA	Low gain mode
Gain	S_{21HG}	14.5	16.0	17.5	dB	High gain mode
	S_{21LG}	-8.8	-6.3	-3.3	dB	Low gain mode
Reverse Isolation	S_{12HG}	–	-34	-25	dB	High gain mode
	S_{12LG}	-8.8	-6.3	-3.3	dB	Low gain mode
Noise figure	NF_{HG}	0.6	0.9	1.4	dB	High gain mode
	NF_{LG}	3.3	6.3	8.8	dB	Low gain mode
Input return loss	S_{11HG}	–	-16	-10	dB	50 Ω , high gain mode
	S_{11LG}	–	-11	-9	dB	50 Ω , low gain mode
Output return loss	S_{22HG}	–	-16	-10	dB	50 Ω , high gain mode
	S_{22LG}	–	-10	-8	dB	50 Ω , low gain mode
Stability factor	k	>1	>2.3	–		DC to 8 GHz; all gain modes
Input compression point	IP_{1dBHG}	-16	-9	–	dBm	High gain mode
	$IP_{1dB LG}$	-10	-2	–	dBm	Low gain mode
Inband IIP3 $f_1 - f_2 = 1\text{ MHz}$	$IIP3_{HG}$	-9	-2	–	dBm	High gain mode
	$IIP3_{LG}$	-7	5	–	dBm	Low gain mode

1) Performance based on application circuit in Figure 2 on Page 28

2) Guaranteed by device design; not tested in production.

2.10 Measured RF Characteristics UMTS Band 7

Table 8 Typical Characteristics 2650 MHz Band, $T_A = 25\text{ °C}$, $V_{CC} = 2.8\text{ V}^{1)}$

Parameter	Symbol	Values			Unit	Note / Test Condition
		Min.	Typ.	Max.		
Pass band range band VII		2620	–	2690	MHz	–
Current consumption	I_{CCHG}	3.6	4.2	4.8	mA	High gain mode
	I_{CCLG}	0.3	0.53	0.7	mA	Low gain mode
Gain	S_{21HG}	14.4	15.7	17.0	dB	High gain mode
	S_{21LG}	-9.6	-7.1	-4.1	dB	Low gain mode
Reverse Isolation ²⁾	S_{12HG}	–	-34	-25	dB	High gain mode
	S_{12LG}	-9.5	-7.0	-4.0	dB	Low gain mode
Noise figure	NF_{HG}	0.9	1.2	1.7	dB	High gain mode
	NF_{LG}	3.8	6.8	9.3	dB	Low gain mode
Input return loss ²⁾	S_{11HG}	–	-20	-10	dB	50 Ω , high gain mode
	S_{11LG}	–	-10	-8	dB	50 Ω , low gain mode
Output return loss ²⁾	S_{22HG}	–	-20	-10	dB	50 Ω , high gain mode
	S_{22LG}	–	-11	-9	dB	50 Ω , low gain mode
Stability factor ³⁾	k	>1	>2.3	–		DC to 8 GHz; all gain modes
Input compression point ²⁾	IP_{1dBHG}	-17	-10	–	dBm	High gain mode
	IP_{1dBLG}	-10	-2	–	dBm	Low gain mode
Inband IIP3 ²⁾ $f_1 - f_2 = 1\text{ MHz}$	$IIP3_{HG}$	-9	-2	–	dBm	High gain mode
	$IIP3_{LG}$	-5	7	–	dBm	Low gain mode

1) Performance based on application circuit in Figure 2 on Page 28

2) Verification based on AQL; random production test..

3) Guaranteed by device design; not tested in production.

2.11 Measured RF Characteristics UMTS Band 7

Table 9 Typical Characteristics 2650 MHz Band, $T_A = 85\text{ °C}$, $V_{CC} = 2.8\text{ V}^{1)2)}$

Parameter	Symbol	Values			Unit	Note / Test Condition
		Min.	Typ.	Max.		
Pass band range band VII		2620	–	2690	MHz	–
Current consumption	I_{CCHG}	4.6	5.2	5.8	mA	High gain mode
	I_{CCLG}	0.2	0.58	0.8	mA	Low gain mode
Gain	S_{21HG}	13.1	14.6	16.1	dB	High gain mode
	S_{21LG}	-10.4	-7.9	-4.9	dB	Low gain mode
Reverse Isolation	S_{12HG}	–	-34	-25	dB	High gain mode
	S_{12LG}	-10.4	-7.9	-4.9	dB	Low gain mode
Noise figure	NF_{HG}	1.4	1.7	2.2	dB	High gain mode
	NF_{LG}	4.9	7.9	10.4	dB	Low gain mode
Input return loss	S_{11HG}	–	-16	-10	dB	50 Ω , high gain mode
	S_{11LG}	–	-11	-9	dB	50 Ω , low gain mode
Output return loss	S_{22HG}	–	-20	-10	dB	50 Ω , high gain mode
	S_{22LG}	–	-11	-9	dB	50 Ω , low gain mode
Stability factor	k	>1	>2.3	–		DC to 8 GHz; all gain modes
Input compression point	IP_{1dBHG}	-17	-10	–	dBm	High gain mode
	IP_{1dBLG}	-10	-2	–	dBm	Low gain mode
Inband IIP3 $f_1 - f_2 = 1\text{ MHz}$	$IIP3_{HG}$	-9	-2	–	dBm	High gain mode
	$IIP3_{LG}$	-3	9	–	dBm	Low gain mode

1) Performance based on application circuit in Figure 2 on Page 28

2) Guaranteed by device design; not tested in production.

2.12 Measured RF Characteristics UMTS Band 38

Table 10 Typical Characteristics 2600 MHz Band, $T_A = -30\text{ °C}$, $V_{CC} = 2.8\text{ V}^{1)2)}$

Parameter	Symbol	Values			Unit	Note / Test Condition
		Min.	Typ.	Max.		
Pass band range band XXXVIII		2570	–	2620	MHz	–
Current consumption	I_{CCHG}	2.8	3.4	4.0	mA	High gain mode
	I_{CCLG}	0.2	0.5	0.8	mA	Low gain mode
Gain	S_{21HG}	14.7	16.2	17.7	dB	High gain mode
	S_{21LG}	-8.5	-6.0	-3.0	dB	Low gain mode
Reverse Isolation	S_{12HG}	–	-34	-25	dB	High gain mode
	S_{12LG}	-8.5	-6.0	-3.0	dB	Low gain mode
Noise figure	NF_{HG}	0.6	0.9	1.4	dB	High gain mode
	NF_{LG}	3.0	6.0	8.5	dB	Low gain mode
Input return loss	S_{11HG}	–	-15	-10	dB	50 Ω , high gain mode
	S_{11LG}	–	-13	-10	dB	50 Ω , low gain mode
Output return loss	S_{22HG}	–	-11	-9	dB	50 Ω , high gain mode
	S_{22LG}	–	-18	-10	dB	50 Ω , low gain mode
Stability factor	k	>1	>2.3	–		DC to 8 GHz; all gain modes
Input compression point	IP_{1dBHG}	-16	-9	–	dBm	High gain mode
	$IP_{1dB LG}$	-10	-2	–	dBm	Low gain mode
Inband IIP3 $f_1 - f_2 = 1\text{ MHz}$	$IIP3_{HG}$	-9	-2	–	dBm	High gain mode
	$IIP3_{LG}$	-7	5	–	dBm	Low gain mode

1) Performance based on application circuit in Figure 3 on Page 29

2) Guaranteed by device design; not tested in production.

2.13 Measured RF Characteristics UMTS Band 38

Table 11 Typical Characteristics 2600 MHz Band, $T_A = 25\text{ °C}$, $V_{CC} = 2.8\text{ V}$ ¹⁾²⁾

Parameter	Symbol	Values			Unit	Note / Test Condition
		Min.	Typ.	Max.		
Pass band range band XXXVIII		2570	–	2620	MHz	–
Current consumption	I_{CCHG}	3.6	4.2	4.8	mA	High gain mode
	I_{CCLG}	0.3	0.53	0.7	mA	Low gain mode
Gain	S_{21HG}	14.2	15.5	16.8	dB	High gain mode
	S_{21LG}	-9.4	-6.9	-3.9	dB	Low gain mode
Reverse Isolation	S_{12HG}	–	-34	-25	dB	High gain mode
	S_{12LG}	-9.5	-7.0	-4.0	dB	Low gain mode
Noise figure	NF_{HG}	0.9	1.2	1.7	dB	High gain mode
	NF_{LG}	3.8	6.8	9.3	dB	Low gain mode
Input return loss	S_{11HG}	–	-15	-10	dB	50 Ω , high gain mode
	S_{11LG}	–	-11	-9	dB	50 Ω , low gain mode
Output return loss	S_{22HG}	–	-15	-10	dB	50 Ω , high gain mode
	S_{22LG}	–	-13	-10	dB	50 Ω , low gain mode
Stability factor	k	>1	>2.3	–		DC to 8 GHz; all gain modes
Input compression point	IP_{1dBHG}	-17	-10	–	dBm	High gain mode
	$IP_{1dB LG}$	-10	-2	–	dBm	Low gain mode
Inband IIP3 $f_1 - f_2 = 1\text{ MHz}$	$IIP3_{HG}$	-9	-2	–	dBm	High gain mode
	$IIP3_{LG}$	-5	7	–	dBm	Low gain mode

1) Performance based on application circuit in Figure 3 on Page 29

2) Guaranteed by device design; not tested in production.

2.14 Measured RF Characteristics UMTS Band 38

Table 12 Typical Characteristics 2600 MHz Band, $T_A = 85\text{ °C}$, $V_{CC} = 2.8\text{ V}$ ¹⁾²⁾

Parameter	Symbol	Values			Unit	Note / Test Condition
		Min.	Typ.	Max.		
Pass band range band XXXVIII		2570	–	2620	MHz	–
Current consumption	I_{CCHG}	4.6	5.2	5.8	mA	High gain mode
	I_{CCLG}	0.2	0.58	0.8	mA	Low gain mode
Gain	S_{21HG}	13.4	14.9	16.4	dB	High gain mode
	S_{21LG}	-9.9	-7.4	-4.4	dB	Low gain mode
Reverse Isolation	S_{12HG}	–	-34	-25	dB	High gain mode
	S_{12LG}	-9.9	-7.4	-4.4	dB	Low gain mode
Noise figure	NF_{HG}	1.4	1.7	2.2	dB	High gain mode
	NF_{LG}	4.4	7.4	-9.9	dB	Low gain mode
Input return loss	S_{11HG}	–	-16	-10	dB	50 Ω , high gain mode
	S_{11LG}	–	-13	-10	dB	50 Ω , low gain mode
Output return loss	S_{22HG}	–	-16	-10	dB	50 Ω , high gain mode
	S_{22LG}	–	-15	-10	dB	50 Ω , low gain mode
Stability factor	k	>1	>2.3	–		DC to 8 GHz; all gain modes
Input compression point	IP_{1dBHG}	-18	-11	–	dBm	High gain mode
	$IP_{1dB LG}$	-10	-2	–	dBm	Low gain mode
Inband IIP3 $f_1 - f_2 = 1\text{ MHz}$	$IIP3_{HG}$	-9	-2	–	dBm	High gain mode
	$IIP3_{LG}$	-3	9	–	dBm	Low gain mode

1) Performance based on application circuit in Figure 3 on Page 29

2) Guaranteed by device design; not tested in production.

2.15 Measured RF Characteristics UMTS Band 40

Table 13 Typical Characteristics 2300 MHz Band, $T_A = -30\text{ °C}$, $V_{CC} = 2.8\text{ V}^{1)2)}$

Parameter	Symbol	Values			Unit	Note / Test Condition
		Min.	Typ.	Max.		
Pass band range band XL		2300	–	2400	MHz	–
Current consumption	I_{CCHG}	2.8	3.4	4.0	mA	High gain mode
	I_{CCLG}	0.2	0.5	0.8	mA	Low gain mode
Gain	S_{21HG}	15.8	17.3	18.8	dB	High gain mode
	S_{21LG}	-8.7	-6.2	-3.2	dB	Low gain mode
Reverse Isolation	S_{12HG}	–	-35	-25	dB	High gain mode
	S_{12LG}	-8.7	-6.2	-3.2	dB	Low gain mode
Noise figure	NF_{HG}	0.6	0.9	1.4	dB	High gain mode
	NF_{LG}	3.2	6.2	8.7	dB	Low gain mode
Input return loss	S_{11HG}	–	-17	-10	dB	50 Ω , high gain mode
	S_{11LG}	–	-13	-10	dB	50 Ω , low gain mode
Output return loss	S_{22HG}	–	-16	-10	dB	50 Ω , high gain mode
	S_{22LG}	–	-14	-10	dB	50 Ω , low gain mode
Stability factor	k	>1	>2.3	–		DC to 8 GHz; all gain modes
Input compression point	IP_{1dBHG}	-17	-10	–	dBm	High gain mode
	$IP_{1dB LG}$	-10	-2	–	dBm	Low gain mode
Inband IIP3 $f_1 - f_2 = 1\text{ MHz}$	$IIP3_{HG}$	-9	-2	–	dBm	High gain mode
	$IIP3_{LG}$	-7	5	–	dBm	Low gain mode

1) Performance based on application circuit in Figure 4 on Page 30

2) Guaranteed by device design; not tested in production.

2.16 Measured RF Characteristics UMTS Band 40

Table 14 Typical Characteristics 2300 MHz Band, $T_A = 25\text{ °C}$, $V_{CC} = 2.8\text{ V}^{1)2)}$

Parameter	Symbol	Values			Unit	Note / Test Condition
		Min.	Typ.	Max.		
Pass band range band XL		2300	–	2400	MHz	–
Current consumption	I_{CCHG}	3.6	4.2	4.8	mA	High gain mode
	I_{CCLG}	0.3	0.53	0.7	mA	Low gain mode
Gain	S_{21HG}	15.5	16.8	18.1	dB	High gain mode
	S_{21LG}	-9.7	-7.2	-4.2	dB	Low gain mode
Reverse Isolation	S_{12HG}	–	-35	-25	dB	High gain mode
	S_{12LG}	-9.5	-7.0	-4.0	dB	Low gain mode
Noise figure	NF_{HG}	0.9	1.2	1.7	dB	High gain mode
	NF_{LG}	4.0	7.0	9.5	dB	Low gain mode
Input return loss	S_{11HG}	–	-23	-10	dB	50 Ω , high gain mode
	S_{11LG}	–	-12	-10	dB	50 Ω , low gain mode
Output return loss	S_{22HG}	–	-15	-10	dB	50 Ω , high gain mode
	S_{22LG}	–	-12	-10	dB	50 Ω , low gain mode
Stability factor	k	>1	>2.3	–		DC to 8 GHz; all gain modes
Input compression point	IP_{1dBHG}	-18	-11	–	dBm	High gain mode
	$IP_{1dB LG}$	-10	-2	–	dBm	Low gain mode
Inband IIP3 $f_1 - f_2 = 1\text{ MHz}$	$IIP3_{HG}$	-9	-2	–	dBm	High gain mode
	$IIP3_{LG}$	-5	7	–	dBm	Low gain mode

1) Performance based on application circuit in Figure 4 on Page 30

2) Guaranteed by device design; not tested in production.

2.17 Measured RF Characteristics UMTS Band 40

Table 15 Typical Characteristics 2300 MHz Band, $T_A = 85\text{ °C}$, $V_{CC} = 2.8\text{ V}^{1)2)}$

Parameter	Symbol	Values			Unit	Note / Test Condition
		Min.	Typ.	Max.		
Pass band range band XL		2300	–	2400	MHz	–
Current consumption	I_{CCHG}	4.6	5.2	5.8	mA	High gain mode
	I_{CCLG}	0.2	0.58	0.8	mA	Low gain mode
Gain	S_{21HG}	14.5	16.0	17.5	dB	High gain mode
	S_{21LG}	-10.1	-7.6	-4.6	dB	Low gain mode
Reverse Isolation	S_{12HG}	–	-35	-25	dB	High gain mode
	S_{12LG}	-10.1	-7.6	-4.6	dB	Low gain mode
Noise figure	NF_{HG}	1.2	1.5	2.0	dB	High gain mode
	NF_{LG}	4.6	7.6	10.1	dB	Low gain mode
Input return loss	S_{11HG}	–	-18	-10	dB	50 Ω , high gain mode
	S_{11LG}	–	-13	-10	dB	50 Ω , low gain mode
Output return loss	S_{22HG}	–	-17	-10	dB	50 Ω , high gain mode
	S_{22LG}	–	-13	-10	dB	50 Ω , low gain mode
Stability factor	k	>1	>2.3	–		DC to 8 GHz; all gain modes
Input compression point	IP_{1dBHG}	-19	-12	–	dBm	High gain mode
	$IP_{1dB LG}$	-10	-2	–	dBm	Low gain mode
Inband IIP3 $f_1 - f_2 = 1\text{ MHz}$	$IIP3_{HG}$	-9	-2	–	dBm	High gain mode
	$IIP3_{LG}$	-3	9	–	dBm	Low gain mode

1) Performance based on application circuit in Figure 4 on Page 30

2) Guaranteed by device design; not tested in production.

2.18 Measured Performance Band 7 Application High Gain Mode vs. Frequency

$T_A = 25\text{ }^\circ\text{C}$, $V_{CC} = 2.8\text{ V}$, $V_{GS} = 2.8\text{ V}$, $V_{EN} = 2.8\text{ V}$

Power Gain $|S_{21}| = f(f)$

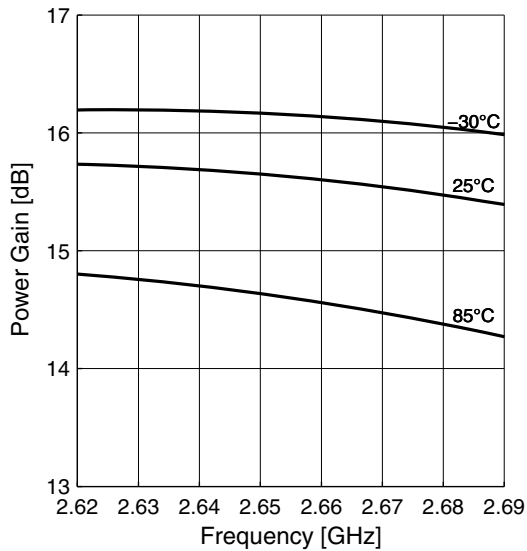

Power Gain wideband $|S_{21}| = f(f)$

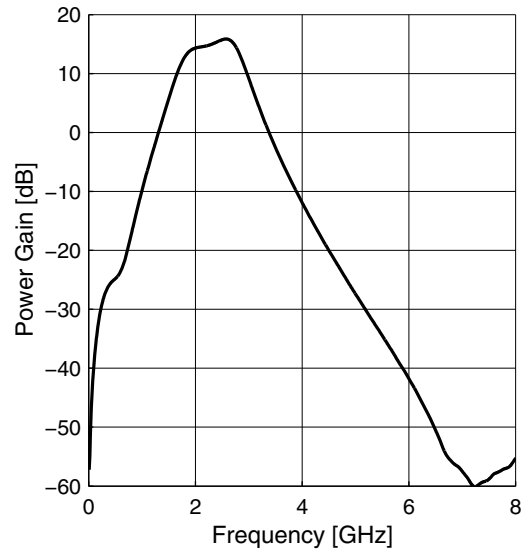

Matching $|S_{11}| = f(f)$, $|S_{22}| = f(f)$

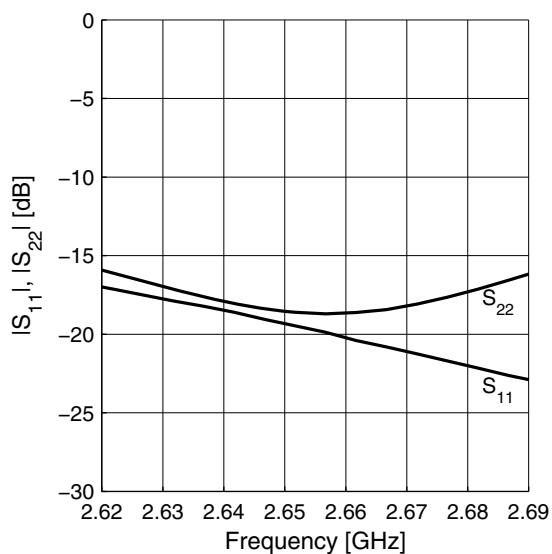

Gainstep HG-LG $\Delta S_{21} = f(f)$

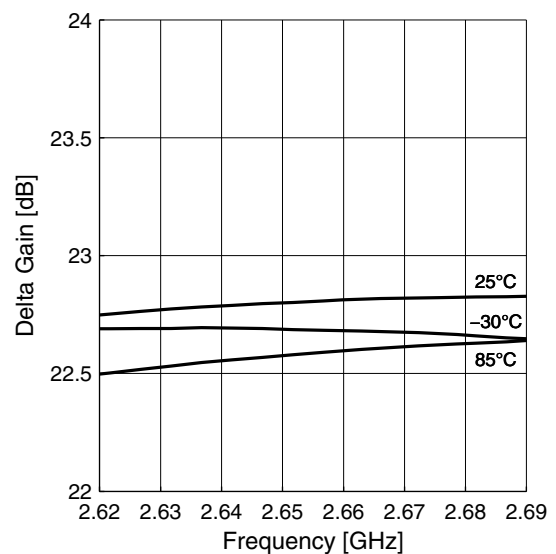

Noise Figure $NF = f(f)$

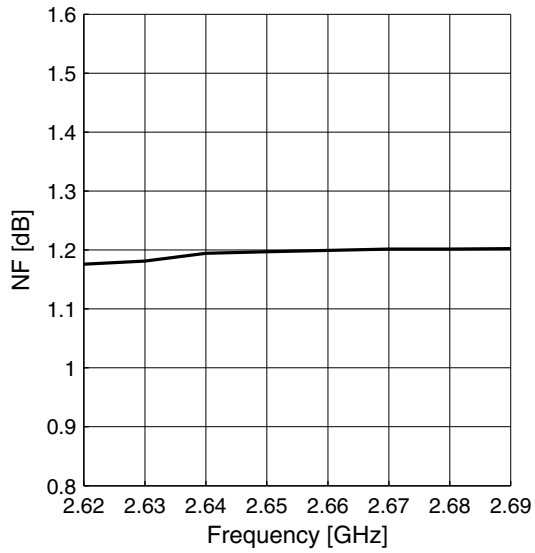

Input Compression $P1dB = f(f)$

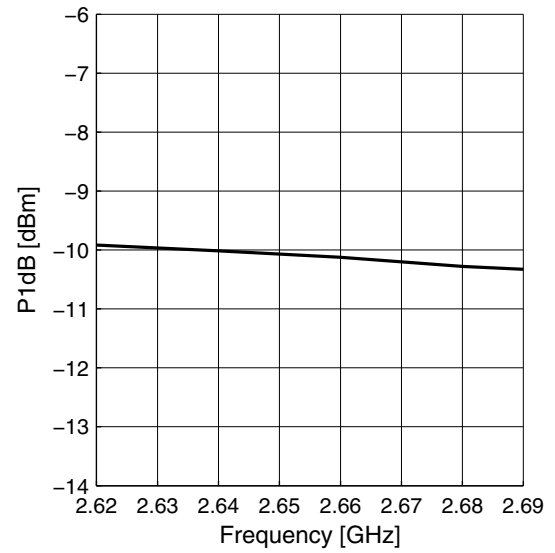

2.19 Measured Performance Band 7 Application High Gain Mode vs. Temperature

$T_A = 25\text{ }^\circ\text{C}$, $V_{CC} = 2.8\text{ V}$, $V_{GS} = 2.8\text{ V}$, $V_{EN} = 2.8\text{ V}$, $f = 2650\text{ MHz}$

Power Gain $|S_{21}| = f(T_A)$

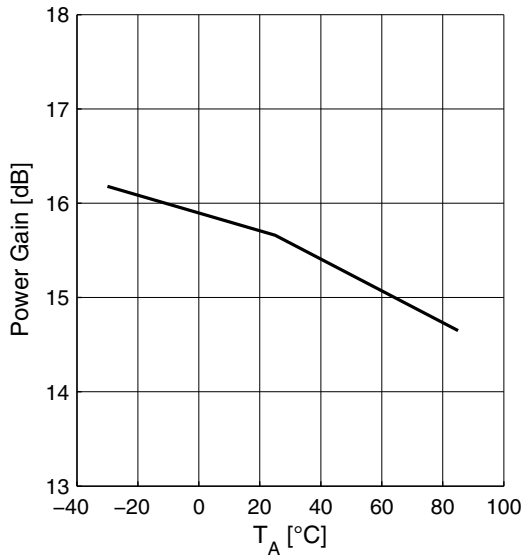

Supply Current $I_{CC} = f(T_A)$

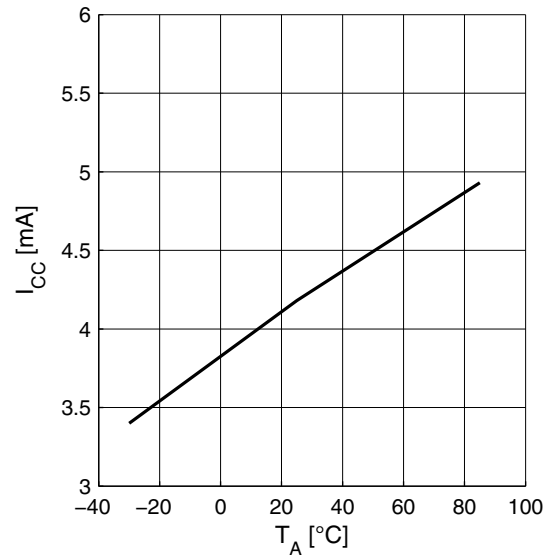

Noise Figure $NF = f(T_A)$

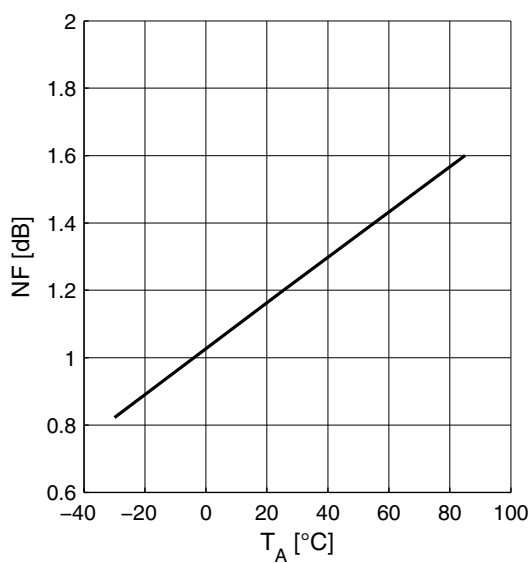

Input Compression $P1dB = f(T_A)$

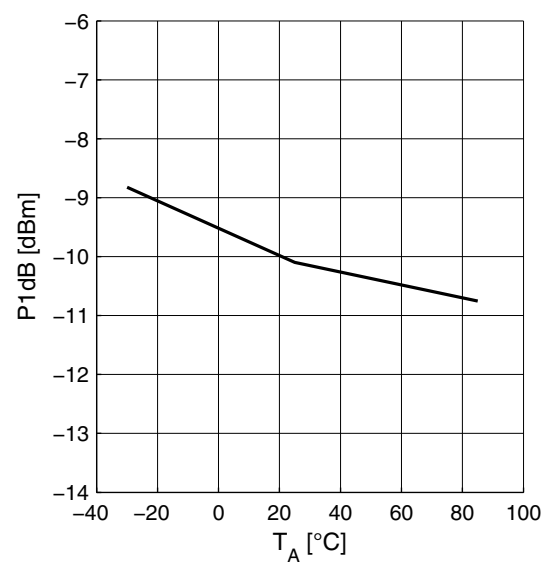

2.20 Measured Performance Band 7 Application Low Gain Mode vs. Frequency

$T_A = 25\text{ }^\circ\text{C}$, $V_{CC} = 2.8\text{ V}$, $V_{GS} = 0\text{ V}$, $V_{EN} = 2.8\text{ V}$

Power Gain $|S_{21}| = f(f)$

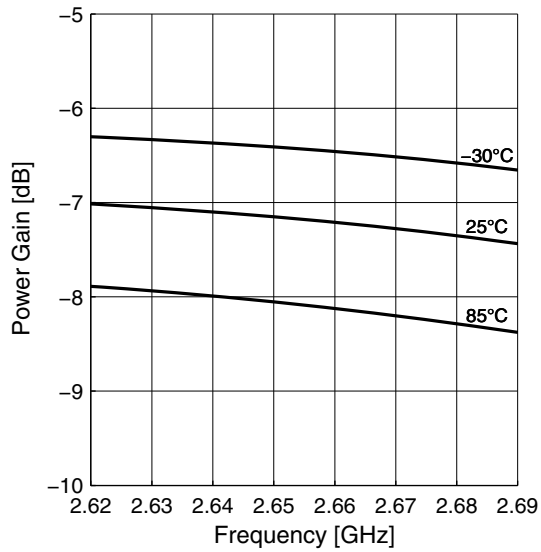

Power Gain wideband $|S_{21}| = f(f)$

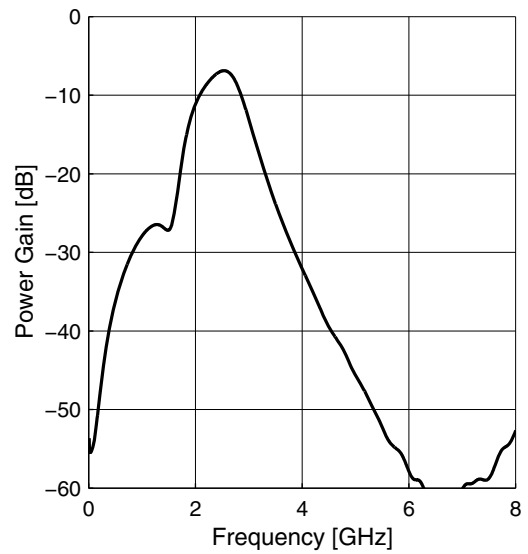

Matching $|S_{11}| = f(f)$, $|S_{22}| = f(f)$

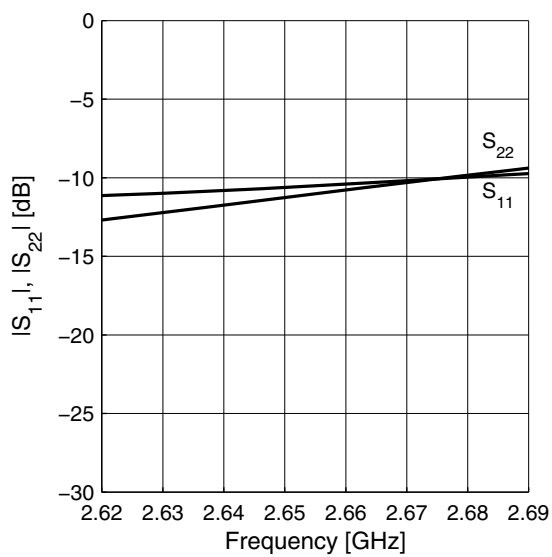

Noise Figure $NF = f(f)$

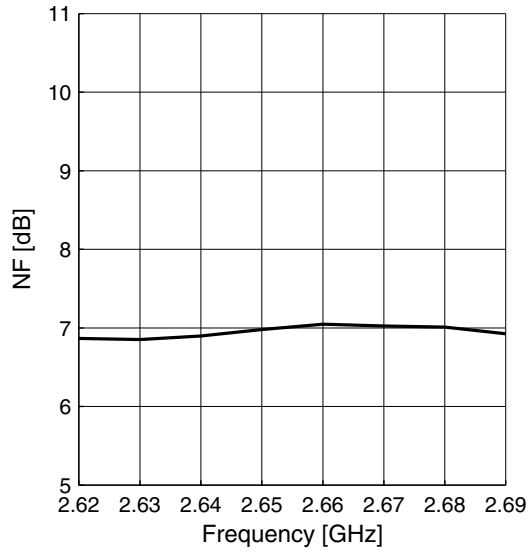

Input Compression $P1dB = f(f)$

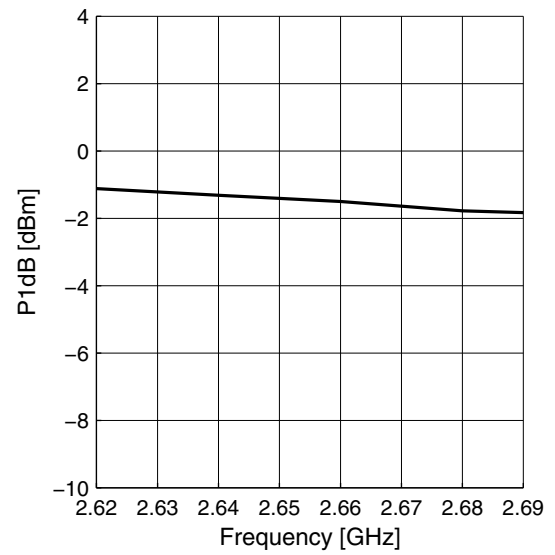

2.21 Measured Performance Band 7 Application Low Gain Mode vs. Temperature

$T_A = 25\text{ }^\circ\text{C}$, $V_{CC} = 2.8\text{ V}$, $V_{GS} = 0\text{ V}$, $V_{EN} = 2.8\text{ V}$, $f = 2650\text{ MHz}$

Power Gain $|S_{21}| = f(T_A)$

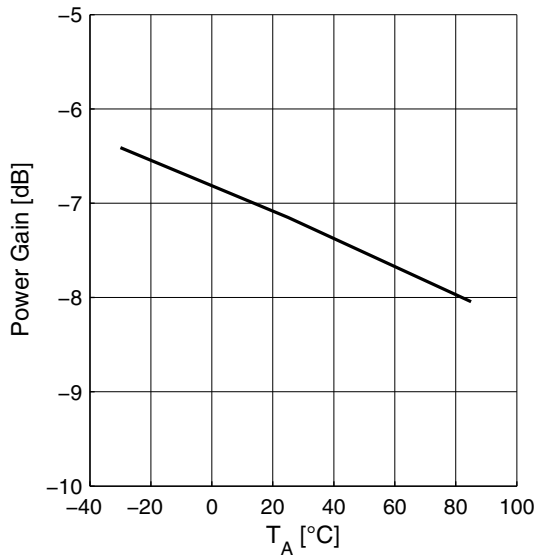

Supply Current $I_{CC} = f(T_A)$

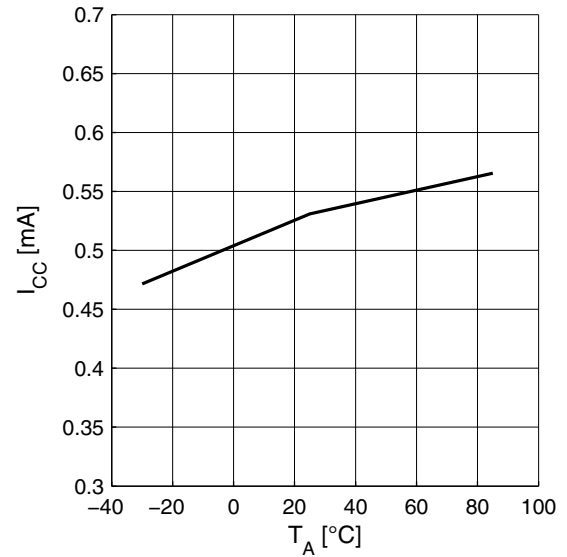

Noise Figure $NF = f(T_A)$

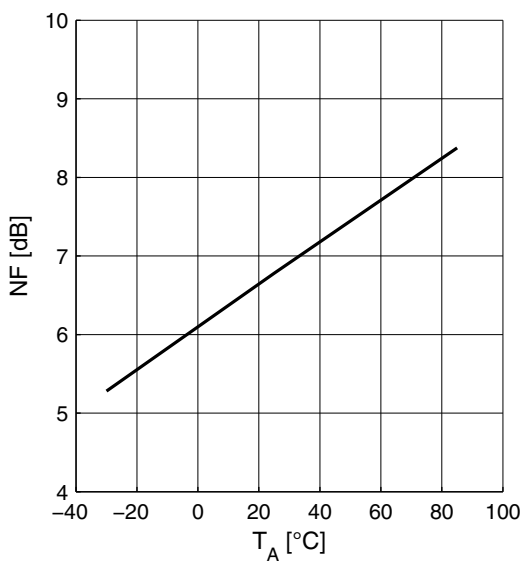

Input Compression $P1dB = f(T_A)$

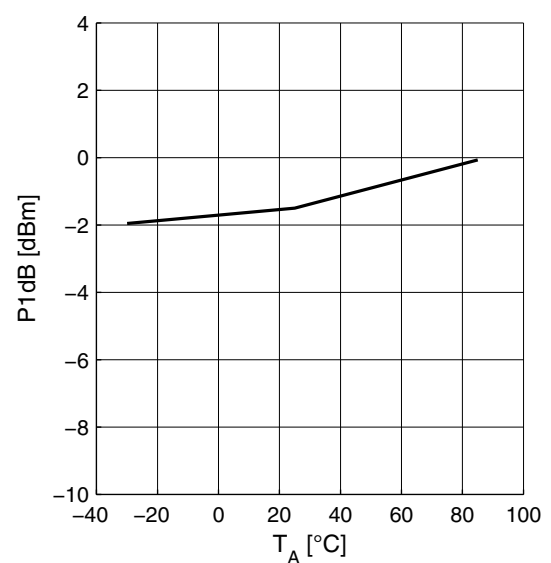

3 Application Circuit and Block Diagram

3.1 UMTS Band 7 Application Circuit Schematic

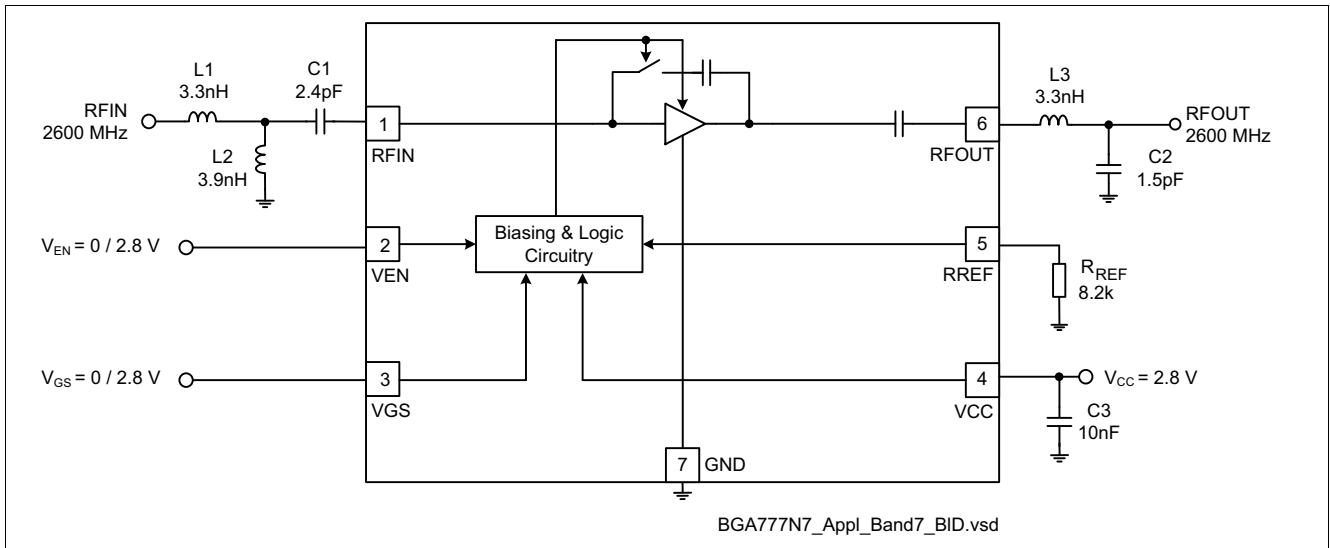

Figure 2 Application Circuit with Chip Outline (Top View)

Note: Package paddle (Pin 0) has to be RF grounded.

Table 16 Bill of Materials

Part Number	Part Type	Manufacturer	Size	Comment
L1 ... L3	Chip inductor	Various	0402	Wirewound, $Q \approx 50$
C1 ... C3	Chip capacitor	Various	0402	
R_{REF}	Chip resistor	Various	0402	

3.2 UMTS Band 38 Application Circuit Schematic

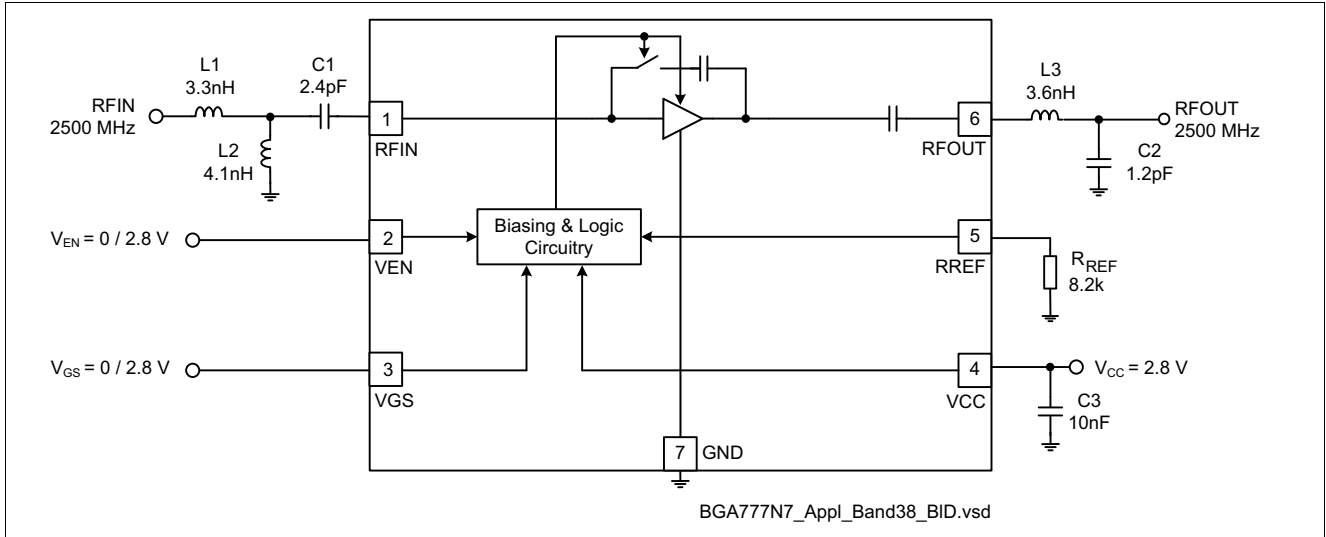

Figure 3 Application Circuit with Chip Outline (Top View)

Note: Package paddle (Pin 0) has to be RF grounded.

Table 17 Bill of Materials

Part Number	Part Type	Manufacturer	Size	Comment
L1 ... L3	Chip inductor	Various	0402	Wirewound, $Q \approx 50$
C1 ... C3	Chip capacitor	Various	0402	
R _{REF}	Chip resistor	Various	0402	

3.3 UMTS Band 40 Application Circuit Schematic

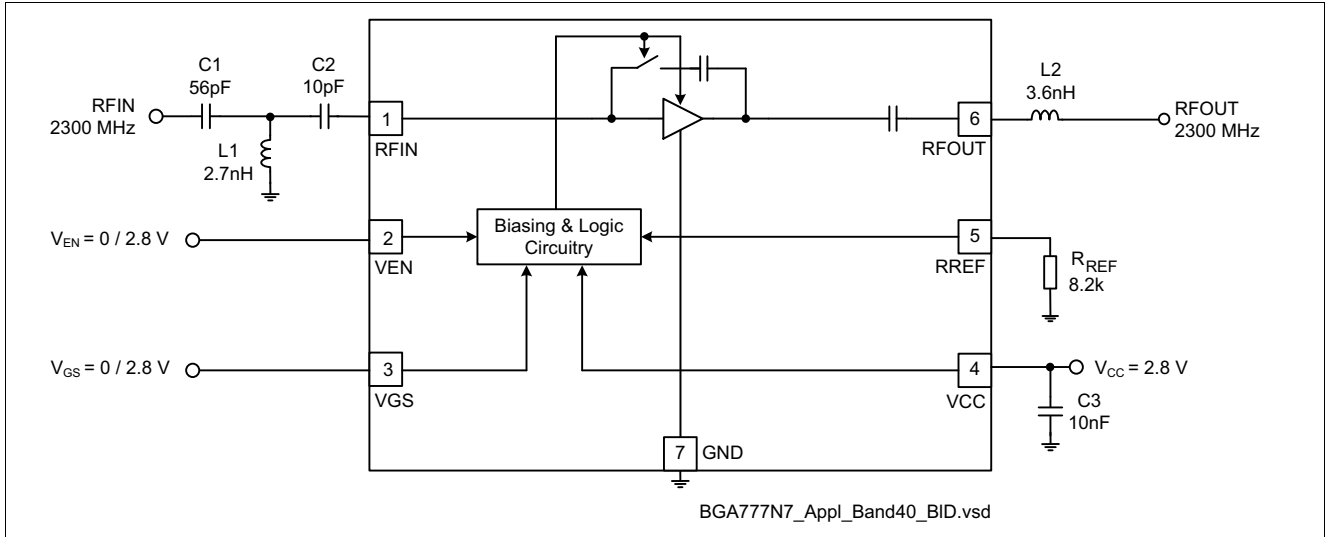

Figure 4 Application Circuit with Chip Outline (Top View)

Note: Package paddle (Pin 0) has to be RF grounded.

Table 18 Bill of Materials

Part Number	Part Type	Manufacturer	Size	Comment
L1 ... L2	Chip inductor	Various	0402	Wirewound, Q ≈ 50
C1 ... C3	Chip capacitor	Various	0402	
R _{REF}	Chip resistor	Various	0402	

3.4 Pin Definition

Table 19 Pin Definition and Function

Pin Number	Symbol	Function
1	RFIN	LNA input (2600 MHz)
2	VEN	Band select control
3	VGS	Gain step control
4	VCC	Supply voltage
5	R _{REF}	Bias current reference resistor (high gain mode)
6	RFOUT	LNA output (2600 MHz)
7	GND	Package paddle; ground connection for LNA and control circuitry

3.5 Application Board

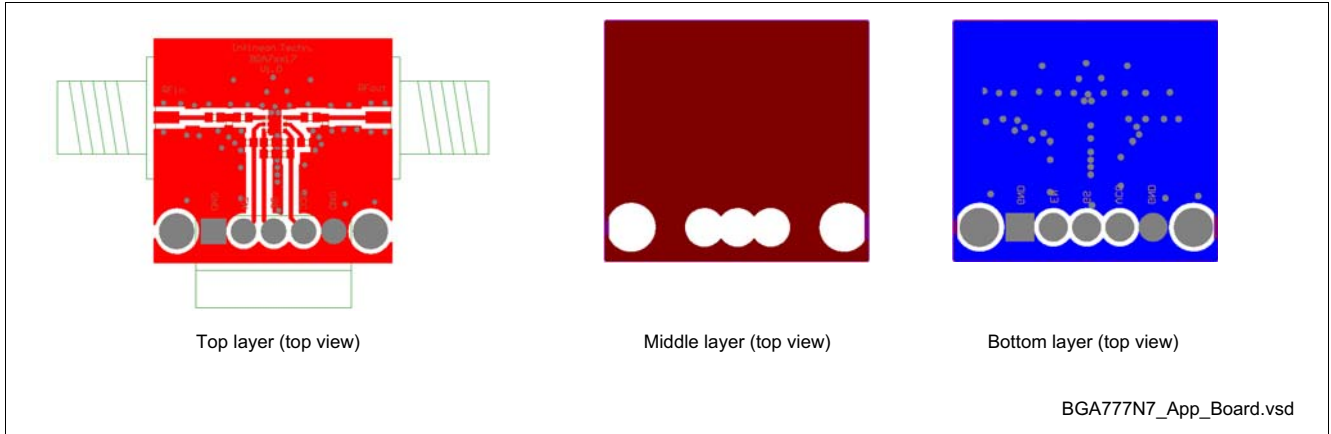

Figure 5 Application Board Layout on 3-Layer FR4

Note: Top layer thickness: 0.2 mm, bottom layer thickness: 0.8 mm, 17 μ m Cu metallization, gold plated. Board size: 21 x 19mm.

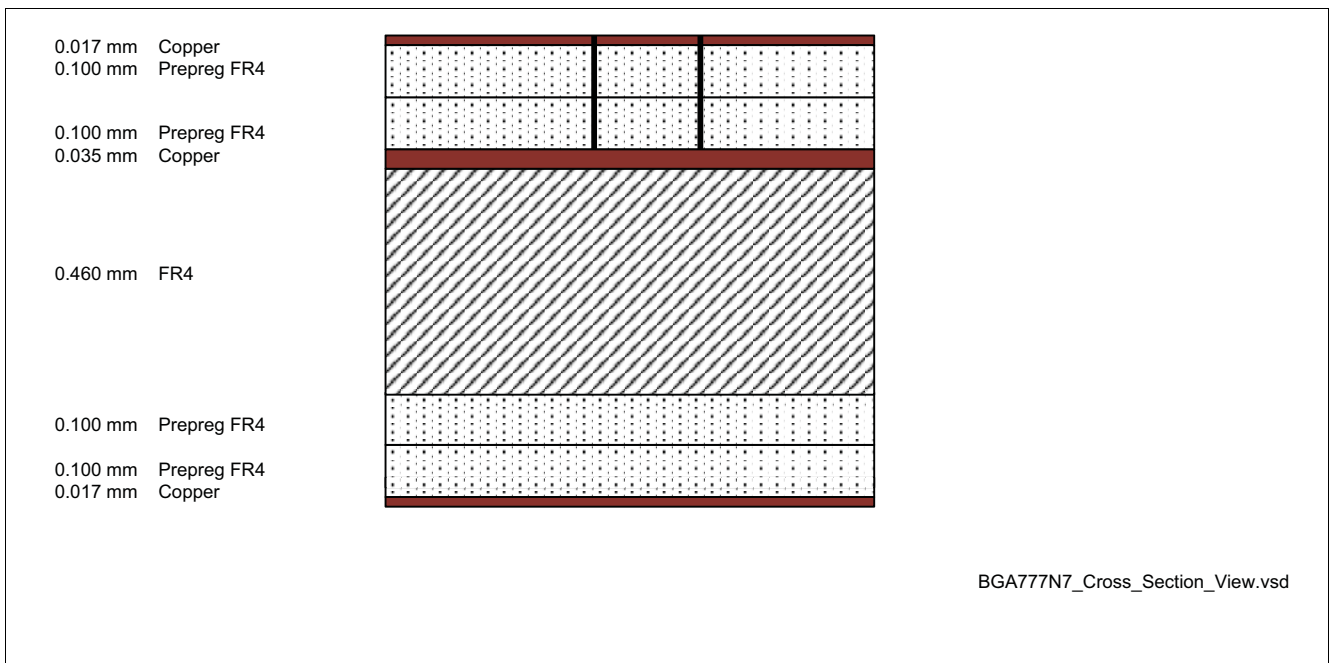

Figure 6 Cross-Section View of Application Board

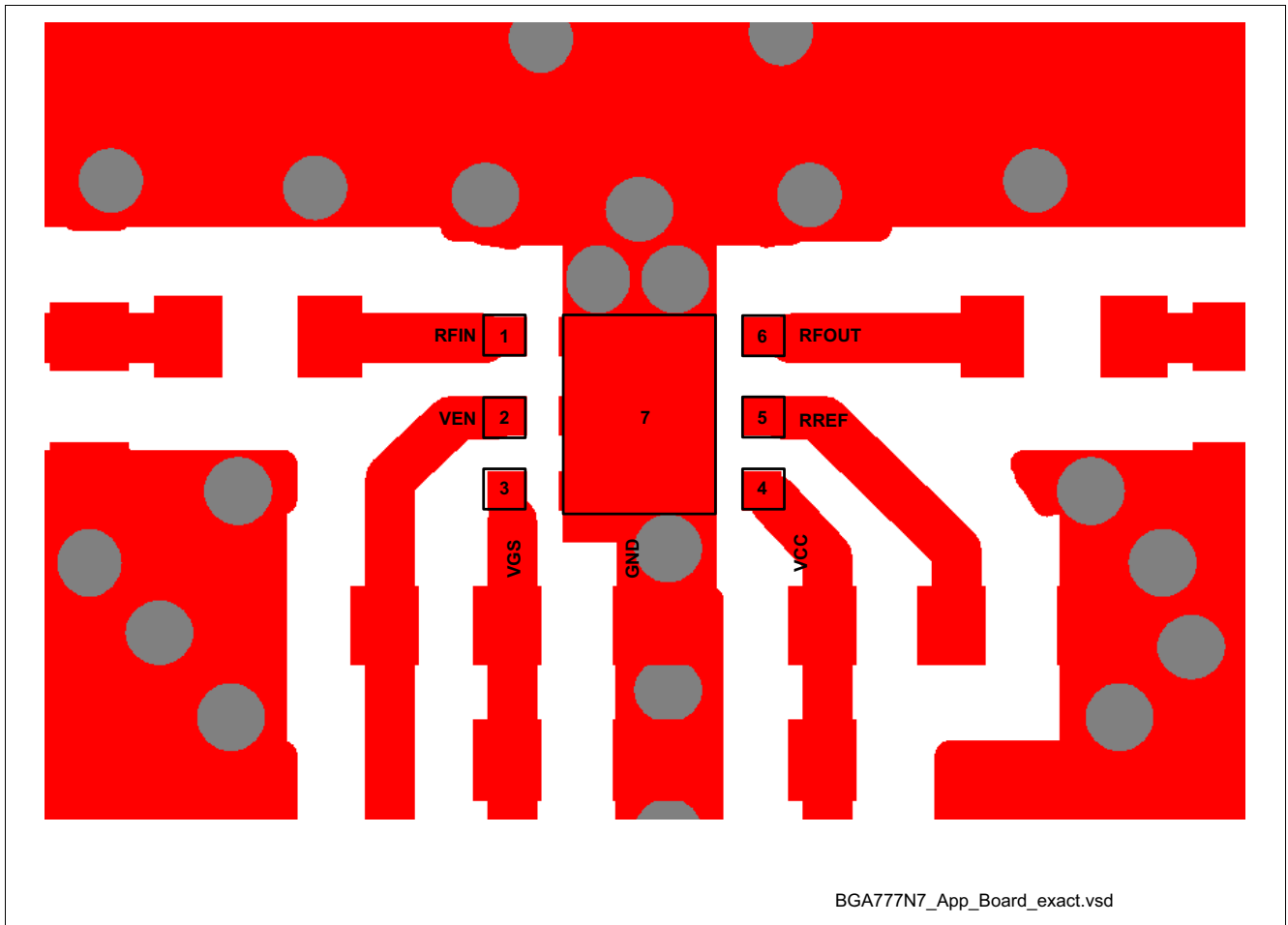

Figure 7 Detail of Application Board Layout

Note: In order to achieve the same performance as given in this datasheet please follow the suggested PCB-layout as closely as possible. The position of the GND vias is critical for RF performance.

4 Physical Characteristics

4.1 Package Footprint

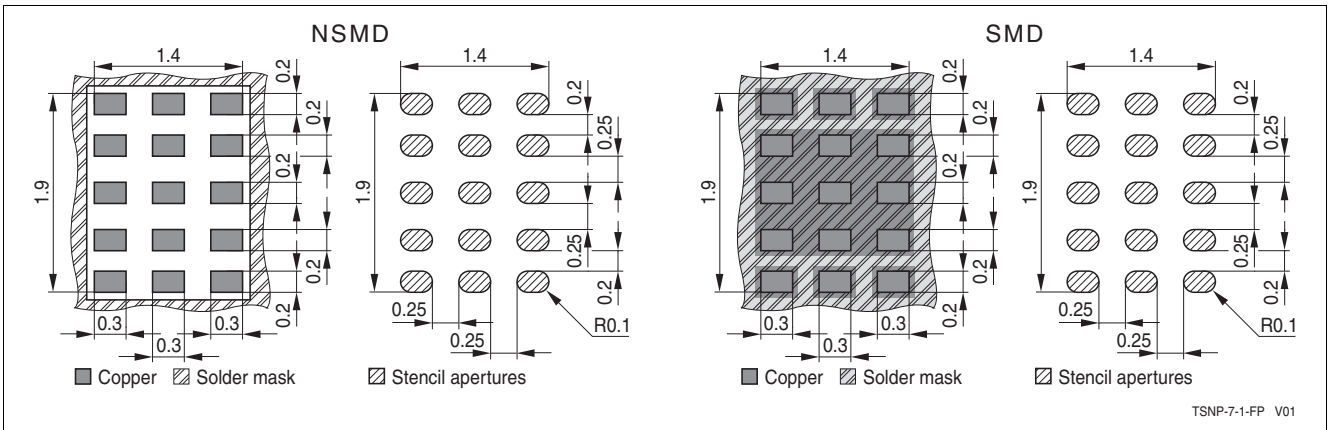

Figure 8 Footprint Recommendation 1 for the TSNP-7-1 Package

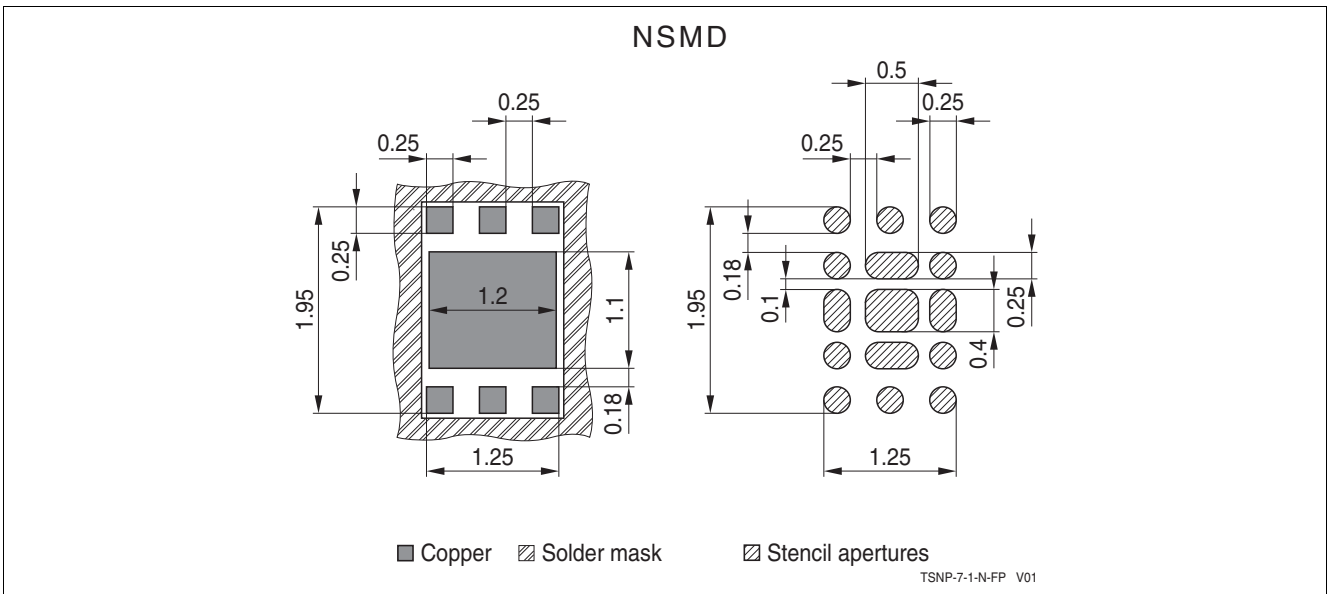

Figure 9 Footprint Recommendation 2 for the TSNP-7-1 Package

4.2 Package Dimensions

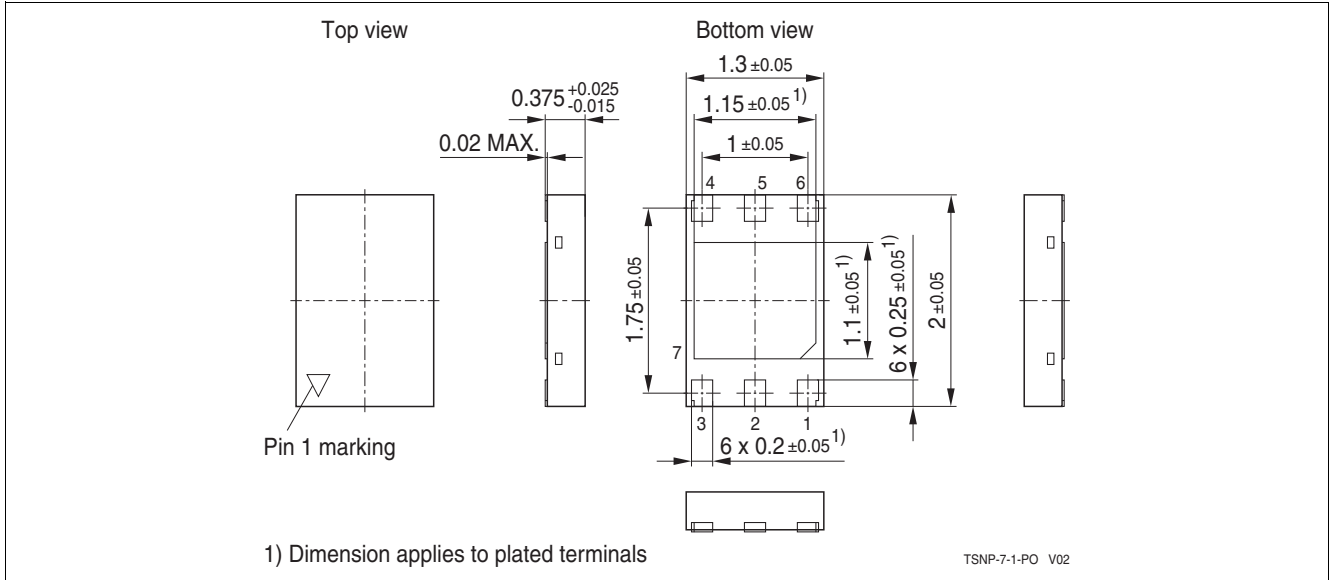

Figure 10 Package Outline (top, side and bottom view)

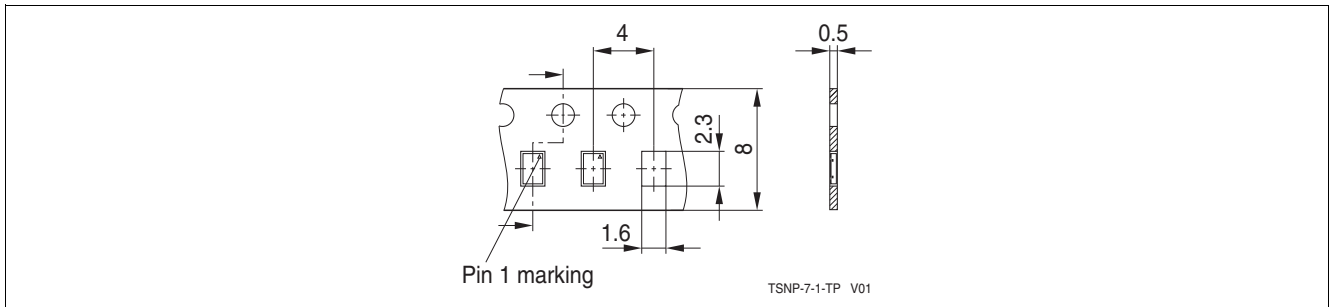

Figure 11 Tape & Reel Dimensions

4.3 Product Marking Pattern

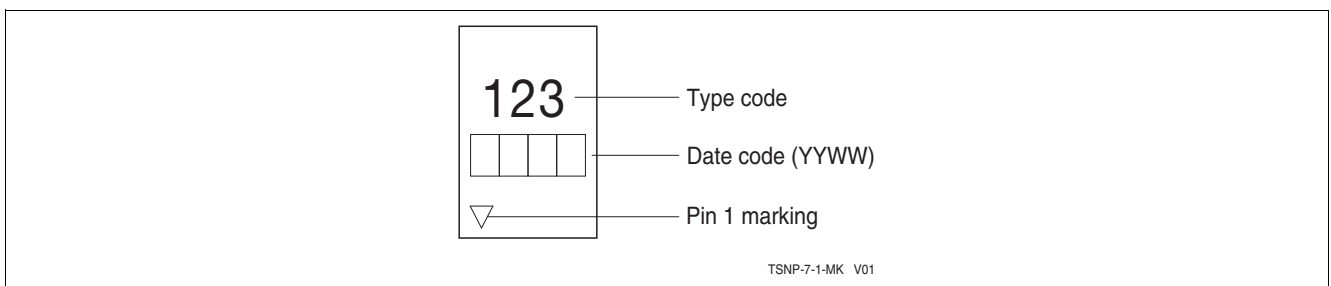

Figure 12 Marking Pattern (top view)

www.infineon.com

Published by Infineon Technologies AG

X-ON Electronics

Largest Supplier of Electrical and Electronic Components

Click to view similar products for [RF Amplifier](#) category:

Click to view products by [Infineon](#) manufacturer:

Other Similar products are found below :

[A82-1](#) [BGA622H6820XTSA1](#) [BGA 728L7 E6327](#) [BGB719N7ESDE6327XTMA1](#) [HMC397-SX](#) [HMC405](#) [HMC561-SX](#) [HMC8120-SX](#)
[HMC8121-SX](#) [HMC-ALH382-SX](#) [HMC-ALH476-SX](#) [SE2433T-R](#) [SMA3101-TL-E](#) [SMA39](#) [A66-1](#) [A66-3](#) [A67-1](#) [LX5535LQ](#) [LX5540LL](#)
[MAAM02350](#) [HMC3653LP3BETR](#) [HMC549MS8GETR](#) [HMC-ALH435-SX](#) [SMA101](#) [SMA32](#) [SMA411](#) [SMA531](#) [SST12LP17E-XX8E](#)
[SST12LP19E-QX6E](#) [WPM0510A](#) [HMC5929LS6TR](#) [HMC5879LS7TR](#) [HMC1126](#) [HMC1087F10](#) [HMC1086](#) [HMC1016](#) [SMA1212](#)
[MAX2689EWS+T](#) [MAAMSS0041TR](#) [MAAM37000-A1G](#) [LTC6430AIUF-15#PBF](#) [CHA5115-QDG](#) [SMA70-2](#) [SMA4011](#) [A231](#) [HMC-](#)
[AUH232](#) [LX5511LQ](#) [LX5511LQ-TR](#) [HMC7441-SX](#) [HMC-ALH310](#)