

SIPMOS[®] Small-Signal-Transistor
Features

- P-Channel
- Enhancement mode
- Avalanche rated
- Logic Level
- dv/dt rated
- Pb-free lead plating; RoHS compliant
- Qualified according to AEC Q101
- Halogen-free according to IEC61249-2-21

Product Summary

Drain source voltage	V_{DS}	-60	V
Drain-source on-state resistance	$R_{DS(on)}$	2	Ω
Continuous drain current	I_D	-0.33	A

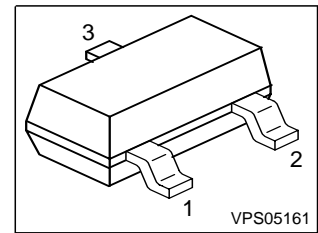

Type	Package	Tape and Reel	Marking	Pin 1	PIN 2	PIN 3
BSS 83 P	PG-SOT-23	H6327: 3000pcs/r.	YAs	G	S	D

Maximum Ratings, at $T_j = 25\text{ °C}$, unless otherwise specified

Parameter	Symbol	Value	Unit
Continuous drain current $T_A = 25\text{ °C}$ $T_A = 70\text{ °C}$	I_D	-0.33 -0.27	A
Pulsed drain current $T_A = 25\text{ °C}$	I_D puls	-1.32	
Avalanche energy, single pulse $I_D = -0.33\text{ A}$, $V_{DD} = -25\text{ V}$, $R_{GS} = 25\ \Omega$	E_{AS}	9.5	mJ
Avalanche energy, periodic limited by T_{jmax}	E_{AR}	0.036	
Reverse diode dv/dt $I_S = -0.33\text{ A}$, $V_{DS} = -48\text{ V}$, $di/dt = 200\text{ A}/\mu\text{s}$, $T_{jmax} = 150\text{ °C}$	dv/dt	6	kV/ μs
Gate source voltage	V_{GS}	± 20	V
Power dissipation $T_A = 25\text{ °C}$	P_{tot}	0.36	W
Operating and storage temperature	T_j, T_{stg}	-55...+150	$^{\circ}\text{C}$
IEC climatic category; DIN IEC 68-1		55/150/56	
ESD Class; JESD22-A114-HBM		Class 0	

Thermal Characteristics

Parameter	Symbol	Values			Unit
		min.	typ.	max.	
Characteristics					
Thermal resistance, junction - soldering point (Pin 3)	R_{thJS}	-	-	150	K/W
SMD version, device on PCB: @ min. footprint @ 6 cm ² cooling area ¹⁾	R_{thJA}	-	-	350 300	

Electrical Characteristics, at $T_j = 25\text{ °C}$, unless otherwise specified

Parameter	Symbol	Values			Unit
		min.	typ.	max.	
Static Characteristics					
Drain- source breakdown voltage $V_{GS} = 0\text{ V}$, $I_D = -250\text{ }\mu\text{A}$	$V_{(BR)DSS}$	-60	-	-	V
Gate threshold voltage, $V_{GS} = V_{DS}$ $I_D = -80\text{ }\mu\text{A}$	$V_{GS(th)}$	-1	-1.5	-2	
Zero gate voltage drain current $V_{DS} = -60\text{ V}$, $V_{GS} = 0\text{ V}$, $T_j = 25\text{ °C}$ $V_{DS} = -60\text{ V}$, $V_{GS} = 0\text{ V}$, $T_j = 125\text{ °C}$	I_{DSS}	-	-0.1 -10	-1 -100	μA
Gate-source leakage current $V_{GS} = -20\text{ V}$, $V_{DS} = 0\text{ V}$	I_{GSS}	-	-10	-100	nA
Drain-source on-state resistance $V_{GS} = -4.5\text{ V}$, $I_D = -0.27\text{ A}$	$R_{DS(on)}$	-	2	3	Ω
Drain-source on-state resistance $V_{GS} = -10\text{ V}$, $I_D = -0.33\text{ A}$	$R_{DS(on)}$	-	1.4	2	

¹Device on 40mm*40mm*1.5mm epoxy PCB FR4 with 6cm² (one layer, 70 μm thick) copper area for drain connection. PCB is vertical without blown air.

Electrical Characteristics, at $T_j = 25\text{ °C}$, unless otherwise specified

Parameter	Symbol	Values			Unit
		min.	typ.	max.	
Dynamic Characteristics					
Transconductance $V_{DS} \geq 2 \cdot I_D \cdot R_{DS(on)max}$, $I_D = -0.27\text{ A}$	g_{fs}	0.24	0.47	-	S
Input capacitance $V_{GS} = 0\text{ V}$, $V_{DS} = -25\text{ V}$, $f = 1\text{ MHz}$	C_{iss}	-	62	78	pF
Output capacitance $V_{GS} = 0\text{ V}$, $V_{DS} = -25\text{ V}$, $f = 1\text{ MHz}$	C_{oss}	-	19	24	
Reverse transfer capacitance $V_{GS} = 0\text{ V}$, $V_{DS} = -25\text{ V}$, $f = 1\text{ MHz}$	C_{rss}	-	7	9	
Turn-on delay time $V_{DD} = -30\text{ V}$, $V_{GS} = -4.5\text{ V}$, $I_D = -0.27\text{ A}$, $R_G = 43\text{ }\Omega$	$t_{d(on)}$	-	23	35	ns
Rise time $V_{DD} = -30\text{ V}$, $V_{GS} = -4.5\text{ V}$, $I_D = -0.27\text{ A}$, $R_G = 43\text{ }\Omega$	t_r	-	71	106	
Turn-off delay time $V_{DD} = -30\text{ V}$, $V_{GS} = -4.5\text{ V}$, $I_D = -0.27\text{ A}$, $R_G = 43\text{ }\Omega$	$t_{d(off)}$	-	56	70	
Fall time $V_{DD} = -30\text{ V}$, $V_{GS} = -4.5\text{ V}$, $I_D = -0.27\text{ A}$, $R_G = 43\text{ }\Omega$	t_f	-	61	76	

Electrical Characteristics, at $T_j = 25\text{ °C}$, unless otherwise specified

Parameter	Symbol	Values			Unit
		min.	typ.	max.	
Dynamic Characteristics					
Gate to source charge $V_{DD} = -48\text{ V}, I_D = -0.33\text{ A}$	Q_{gs}	-	0.12	0.18	nC
Gate to drain charge $V_{DD} = -48\text{ V}, I_D = -0.33\text{ A}$	Q_{gd}	-	1.1	1.65	
Gate charge total $V_{DD} = -48\text{ V}, I_D = -0.33\text{ A}, V_{GS} = 0\text{ to }-10\text{ V}$	Q_g	-	2.38	3.57	
Gate plateau voltage $V_{DD} = -48\text{ V}, I_D = -0.33\text{ A}$	$V_{(\text{plateau})}$	-	-2.94	-	V

Parameter	Symbol	Values			Unit
		min.	typ.	max.	
Reverse Diode					
Inverse diode continuous forward current $T_A = 25\text{ °C}$	I_S	-	-	-0.33	A
Inverse diode direct current, pulsed $T_A = 25\text{ °C}$	I_{SM}	-	-	-1.32	
Inverse diode forward voltage $V_{GS} = 0\text{ V}, I_F = -0.33$	V_{SD}	-	-0.84	-1.1	V
Reverse recovery time $V_R = -30\text{ V}, I_F = I_S, di_F/dt = 80\text{ A}/\mu\text{s}$	t_{rr}	-	59.4	89	ns
Reverse recovery charge $V_R = -30\text{ V}, I_F = I_S, di_F/dt = 80\text{ A}/\mu\text{s}$	Q_{rr}	-	37.5	56	nC

Power Dissipation

$$P_{tot} = f(T_A)$$

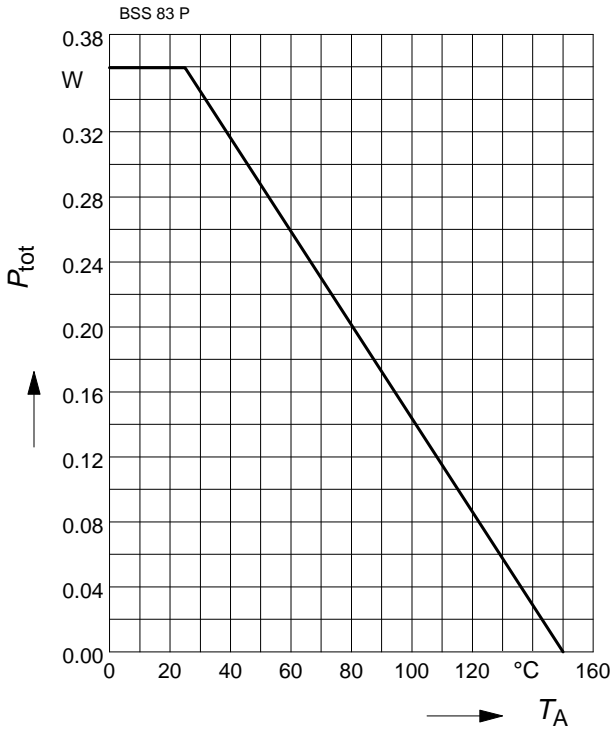

Drain current

$$I_D = f(T_A)$$

parameter: $V_{GS} \geq 10 \text{ V}$

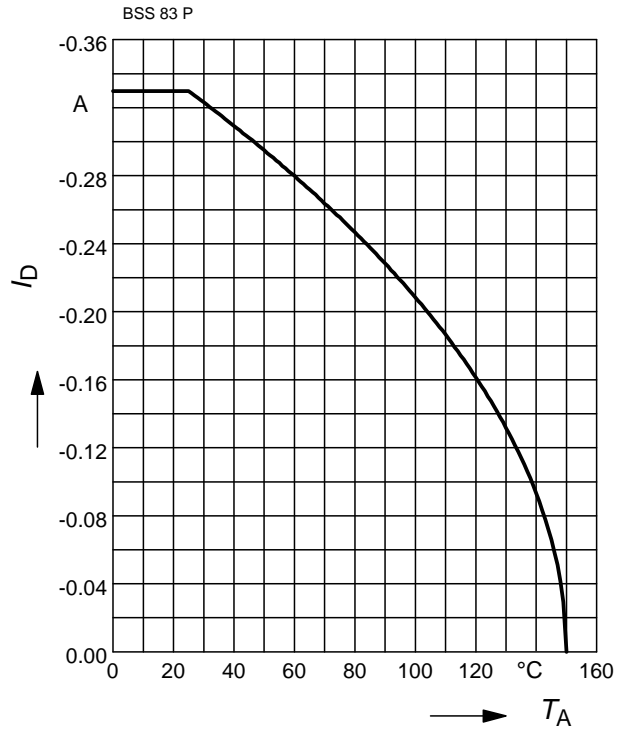

Safe operating area

$$I_D = f(V_{DS})$$

parameter: $D = 0, T_A = 25 \text{ °C}$

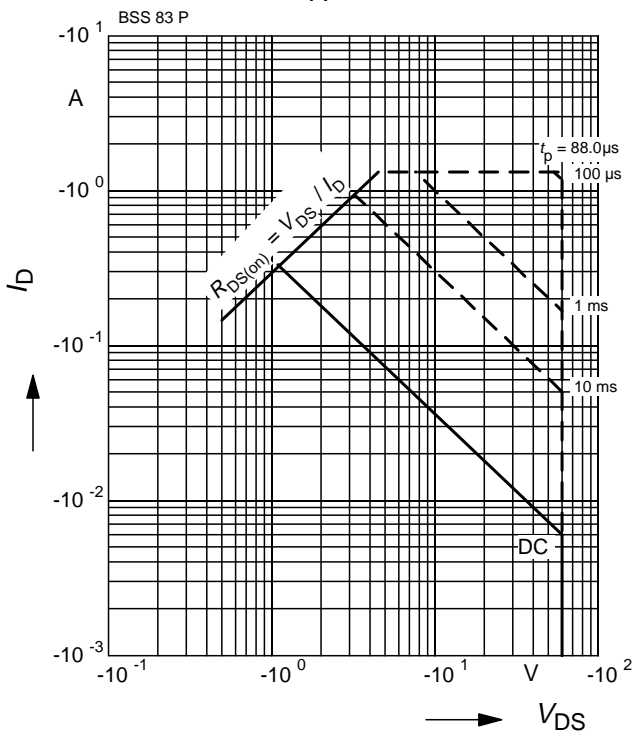

Transient thermal impedance

$$Z_{thJC} = f(t_p)$$

parameter: $D = t_p/T$

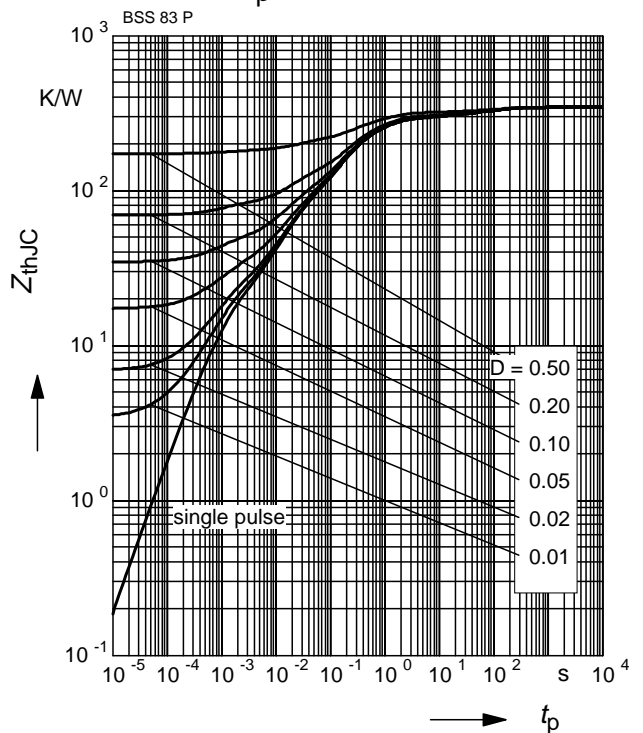

Typ. output characteristic

$I_D = f(V_{DS}); T_j = 25^\circ\text{C}$

parameter: $t_p = 80 \mu\text{s}$

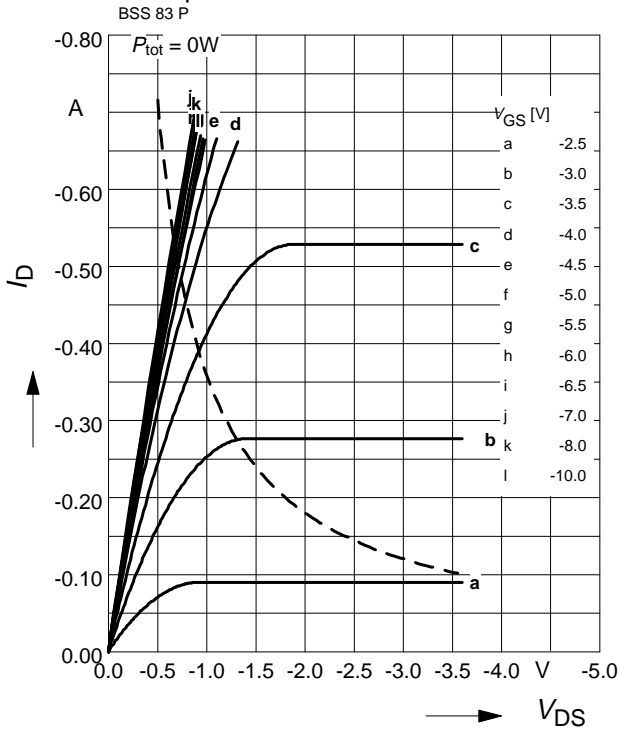

Typ. drain-source-on-resistance

$R_{DS(on)} = f(I_D)$

parameter: V_{GS}

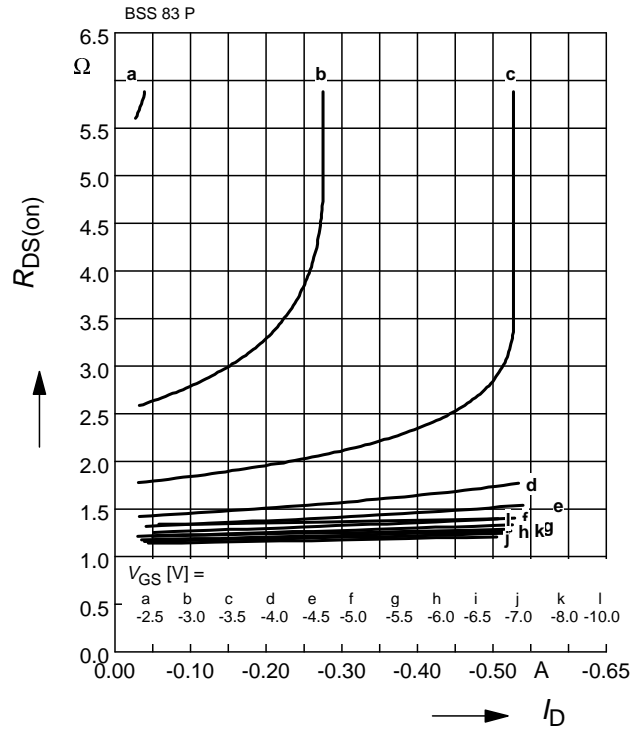

Typ. transfer characteristics $I_D = f(V_{GS})$

$V_{DS} \geq 2 \times I_D \times R_{DS(on)max}$

parameter: $t_p = 80 \mu\text{s}$

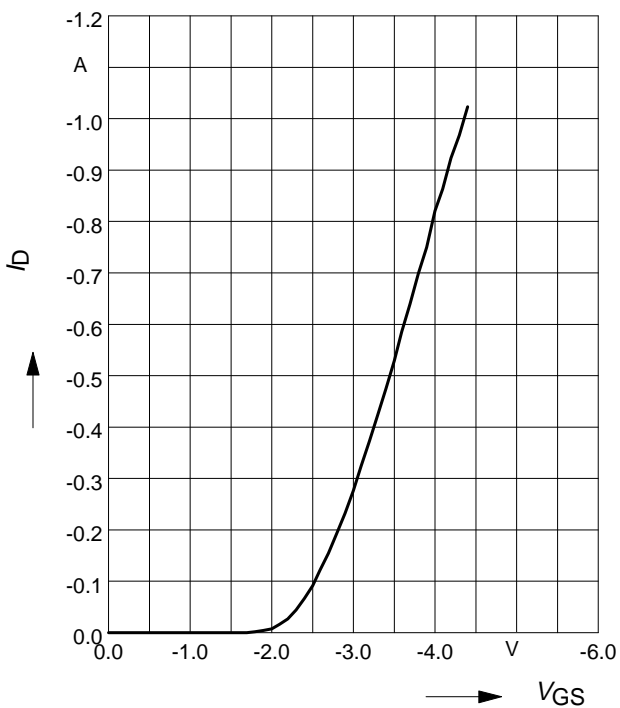

Typ. forward transconductance

$g_{fs} = f(I_D); T_j = 25^\circ\text{C}$

parameter: g_{fs}

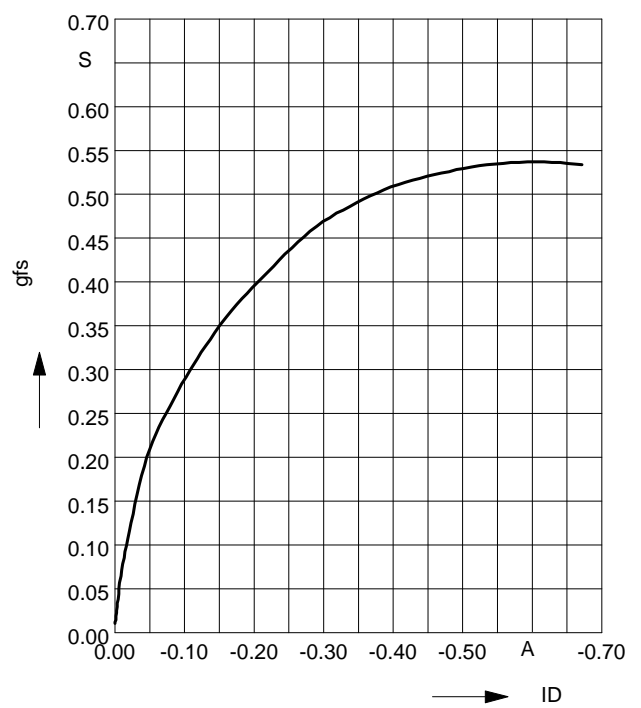

Drain-source on-state resistance

$$R_{DS(on)} = f(T_j)$$

parameter: $I_D = -0.33 \text{ A}$, $V_{GS} = -10 \text{ V}$

BSS 83 P

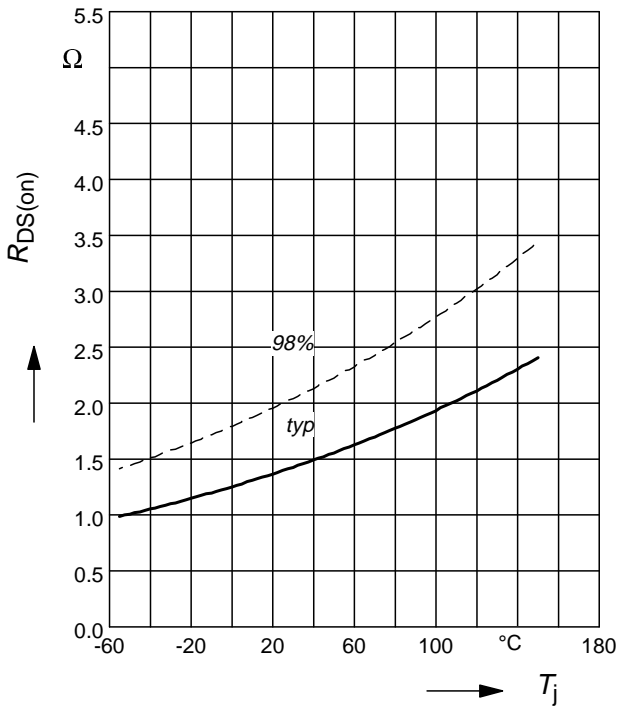

Gate threshold voltage

$$V_{GS(th)} = f(T_j)$$

parameter: $V_{GS} = V_{DS}$, $I_D = -80 \mu\text{A}$

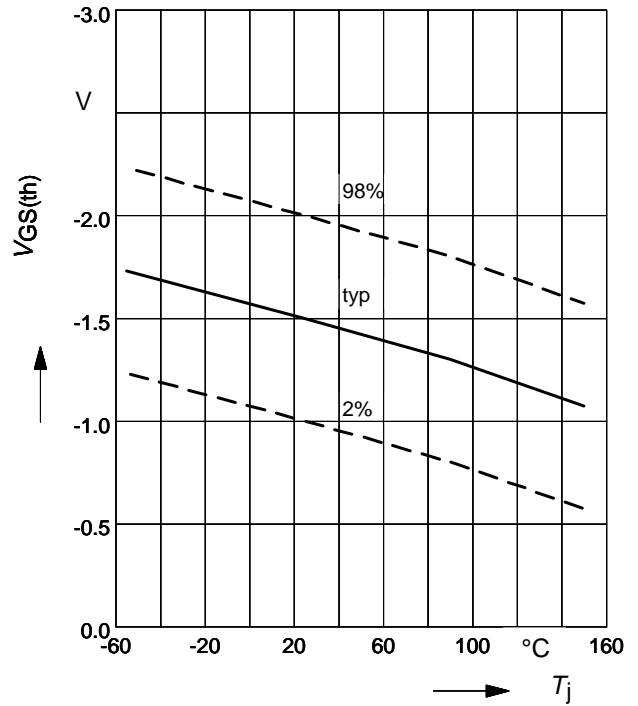

Typ. capacitances

$$C = f(V_{DS})$$

parameter: $V_{GS} = 0 \text{ V}$, $f = 1 \text{ MHz}$

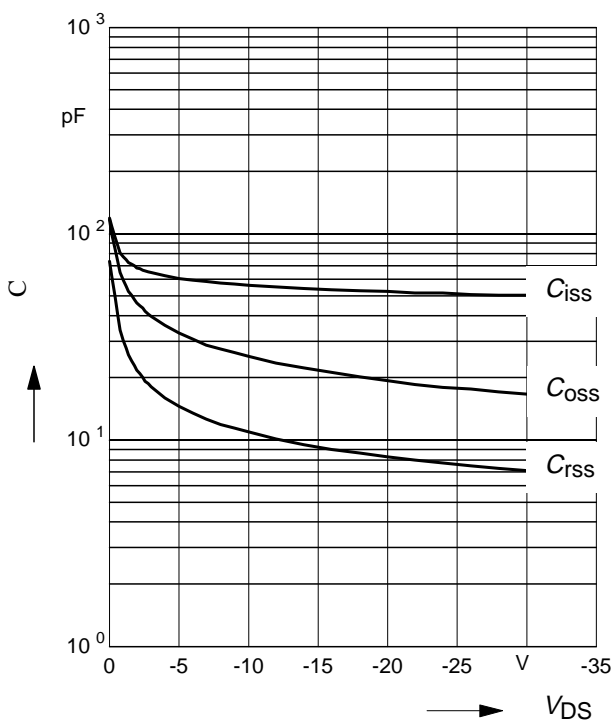

Forward characteristics of reverse diode

$$I_F = f(V_{SD})$$

parameter: T_j , $t_p = 80 \mu\text{s}$

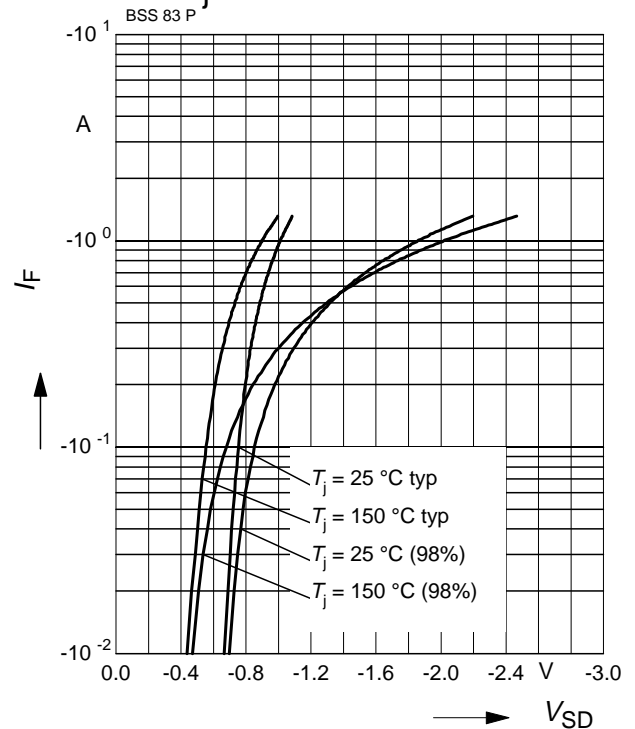

Avalanche energy

$$E_{AS} = f(T_j)$$

para.: $I_D = -0.33 \text{ A}$, $V_{DD} = -25 \text{ V}$, $R_{GS} = 25$

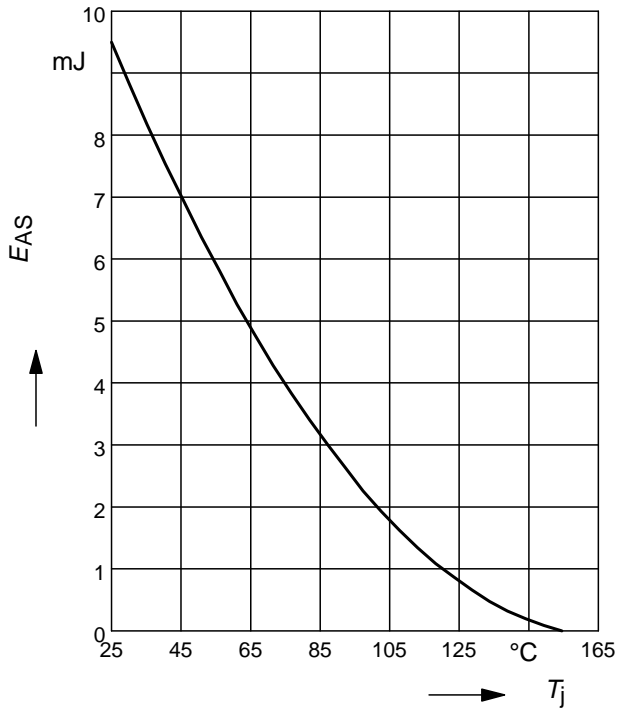

Typ. gate charge

$$V_{GS} = f(Q_{Gate})$$

parameter: $I_D = -0.33 \text{ A}$ pulsed

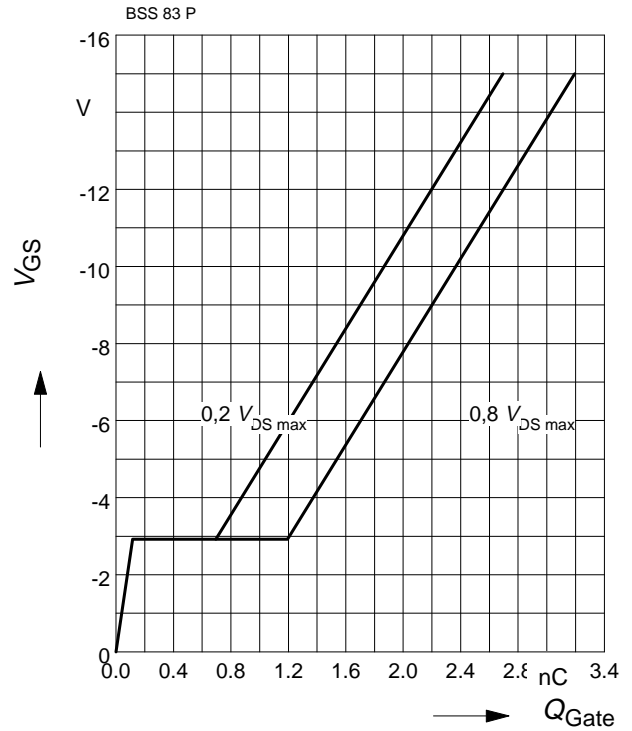

Drain-source breakdown voltage

$$V_{(BR)DSS} = f(T_j)$$

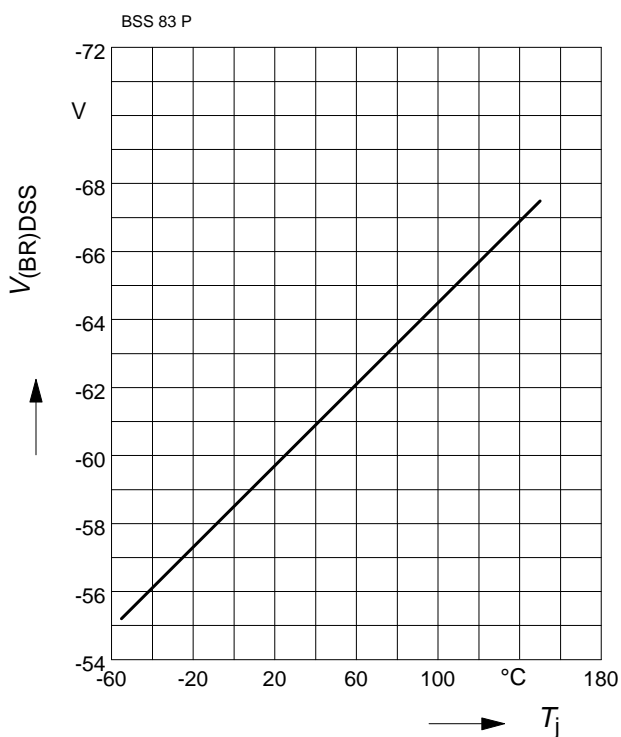

Package Outline:

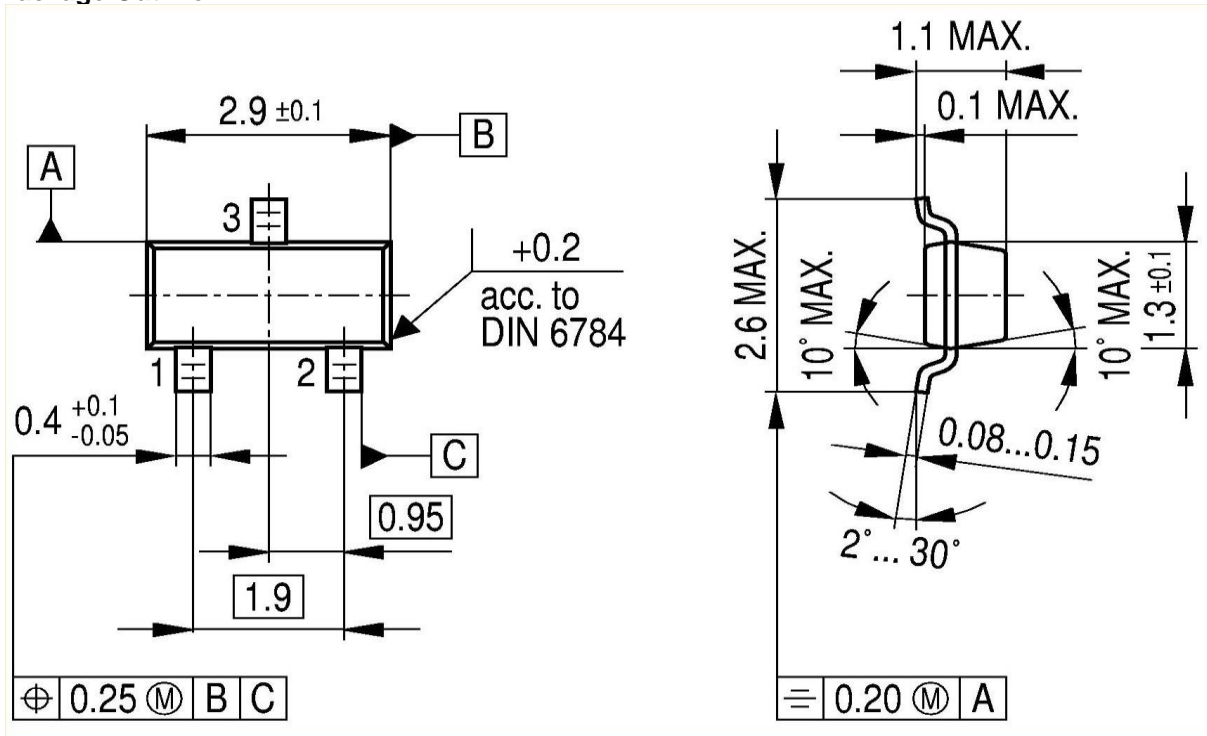

Footprint:

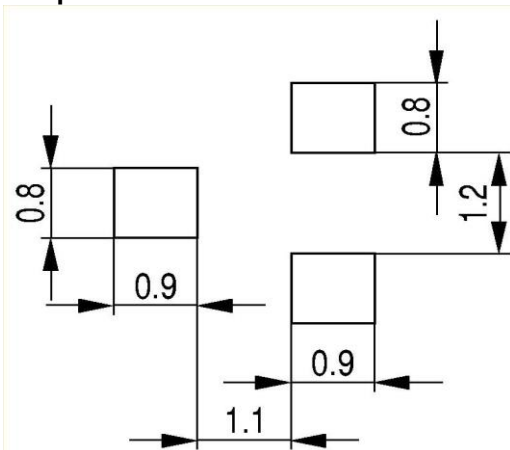

Packaging:

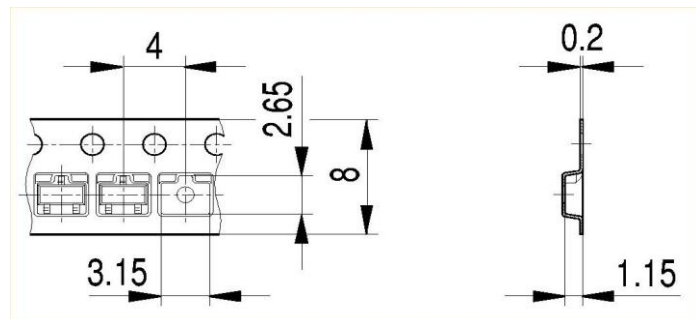

Published by
Infineon Technologies AG
81726 Munich, Germany
© 2010 Infineon Technologies AG
All Rights Reserved.

Legal Disclaimer

The information given in this document shall in no event be regarded as a guarantee of conditions or characteristics. With respect to any examples or hints given herein, any typical values stated herein and/or any information regarding the application of the device, Infineon Technologies hereby disclaims any and all warranties and liabilities of any kind, including without limitation, warranties of non-infringement of intellectual property rights of any third party.

Information

For further information on technology, delivery terms and conditions and prices, please contact the nearest Infineon Technologies Office (www.infineon.com).

Warnings

Due to technical requirements, components may contain dangerous substances. For information on the types in question, please contact the nearest Infineon Technologies Office.

Infineon Technologies components may be used in life-support devices or systems only with the express written approval of Infineon Technologies, if a failure of such components can reasonably be expected to cause the failure of that life-support device or system or to affect the safety or effectiveness of that device or system. Life support devices or systems are intended to be implanted in the human body or to support and/or maintain and sustain and/or protect human life. If they fail, it is reasonable to assume that the health of the user or other persons may be endangered.

X-ON Electronics

Largest Supplier of Electrical and Electronic Components

Click to view similar products for [MOSFET](#) category:

Click to view products by [Infineon](#) manufacturer:

Other Similar products are found below :

[614233C](#) [648584F](#) [IRFD120](#) [JANTX2N5237](#) [FCA20N60_F109](#) [FDZ595PZ](#) [2SK2545\(Q,T\)](#) [405094E](#) [423220D](#) [TPCC8103,L1Q\(CM](#)
[MIC4420CM-TR](#) [VN1206L](#) [614234A](#) [715780A](#) [NTNS3166NZT5G](#) [SSM6J414TU,LF\(T](#) [751625C](#) [BUK954R8-60E](#) [GROUP A 5962-](#)
[8877003PA](#) [NTE6400](#) [SQJ402EP-T1-GE3](#) [2SK2614\(TE16L1,Q\)](#) [2N7002KW-FAI](#) [DMN1017UCP3-7](#) [EFC2J004NUZTDG](#) [ECH8691-TL-W](#)
[FCAB21350L1](#) [P85W28HP2F-7071](#) [DMN1053UCP4-7](#) [NTE221](#) [NTE222](#) [NTE2384](#) [NTE2903](#) [NTE2941](#) [NTE2945](#) [NTE2946](#) [NTE2960](#)
[NTE2967](#) [NTE2969](#) [NTE2976](#) [NTE6400A](#) [NTE2910](#) [NTE2916](#) [NTE2956](#) [NTE2911](#) [DMN2080UCB4-7](#) [TK10A80W,S4X\(S](#)
[SSM6P69NU,LF](#) [DMP22D4UFO-7B](#) [DMN1006UCA6-7](#)