

# PROFET™+

Smart High-Side Power Switch - Demoboard Description

## Demoboard

Rev. 1.4, 2011-02-16

## Table of Contents

<b>1</b>	<b>Overview</b> .....	<b>3</b>
<b>2</b>	<b>Block Diagram</b> .....	<b>4</b>
<b>3</b>	<b>Demoboard Description</b> .....	<b>5</b>
3.1	Detailed Information on the Demoboard .....	6
<b>4</b>	<b>Schematic</b> .....	<b>9</b>
<b>5</b>	<b>PCB drawings</b> .....	<b>10</b>
5.1	Top side .....	10
5.2	Bottom side .....	11
<b>6</b>	<b>Revision History</b> .....	<b>12</b>

## 1 Overview

The Profet+ demoboard consists of a mother board and a daughter board which is plugged onto it. In the picture on the right side, both PCBs are shown.

This demoboard is designed to handle all devices within the PROFET™+ family. Banana connectors are provided for the connection to the power lines. The motherboard contains the entire application circuitry around the PROFET™+ device. Additionally, some useful functions, such as the possibility to connect more than one demoboard to a test set up are implemented.

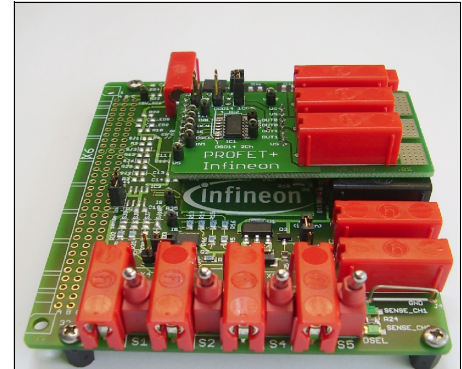

### Application

- Compatible with the entire PROFET™+ family (1- and 2-channel)
- Suitable for evaluation of resistive, inductive and capacitive loads

### Features

- One channel / two channel devices can be evaluated
- One board for the complete family
- Modularity for fast and easy changing of loads and devices within the PROFET™+ family
- Easy indication which switch is optimized for a given load
- Only one power supply needed for start up
- All logic pins are switchable directly on the board
- Also compatible with external logic voltage supplies

**Table 1 Product Summary**

Parameter	Symbol	Values
Operating voltage	$V_{S\_1}$	5.5 V ... 32V <sup>1)</sup>
Operating voltage	$V_{S\_2}$	5.5 V ... 32V <sup>1)</sup>

1)In normal operation higher voltages are supported by the board, but it's recommended to stay below 32V. To use the board with higher voltages see [Chapter 3.1](#).

Type	Package	Marking
PROFET™ +		PROFET™ + Demoboard

## 2 Block Diagram

This block diagram gives an overview of the locations of the Jumpers and Dip switches as well as the functionality behind. For the first start-up please short the Jumper JP1 and connect a voltage source to VS\_1/VS\_2 and the GND. The voltage can be chosen within the full range of the PROFET™+ specification.

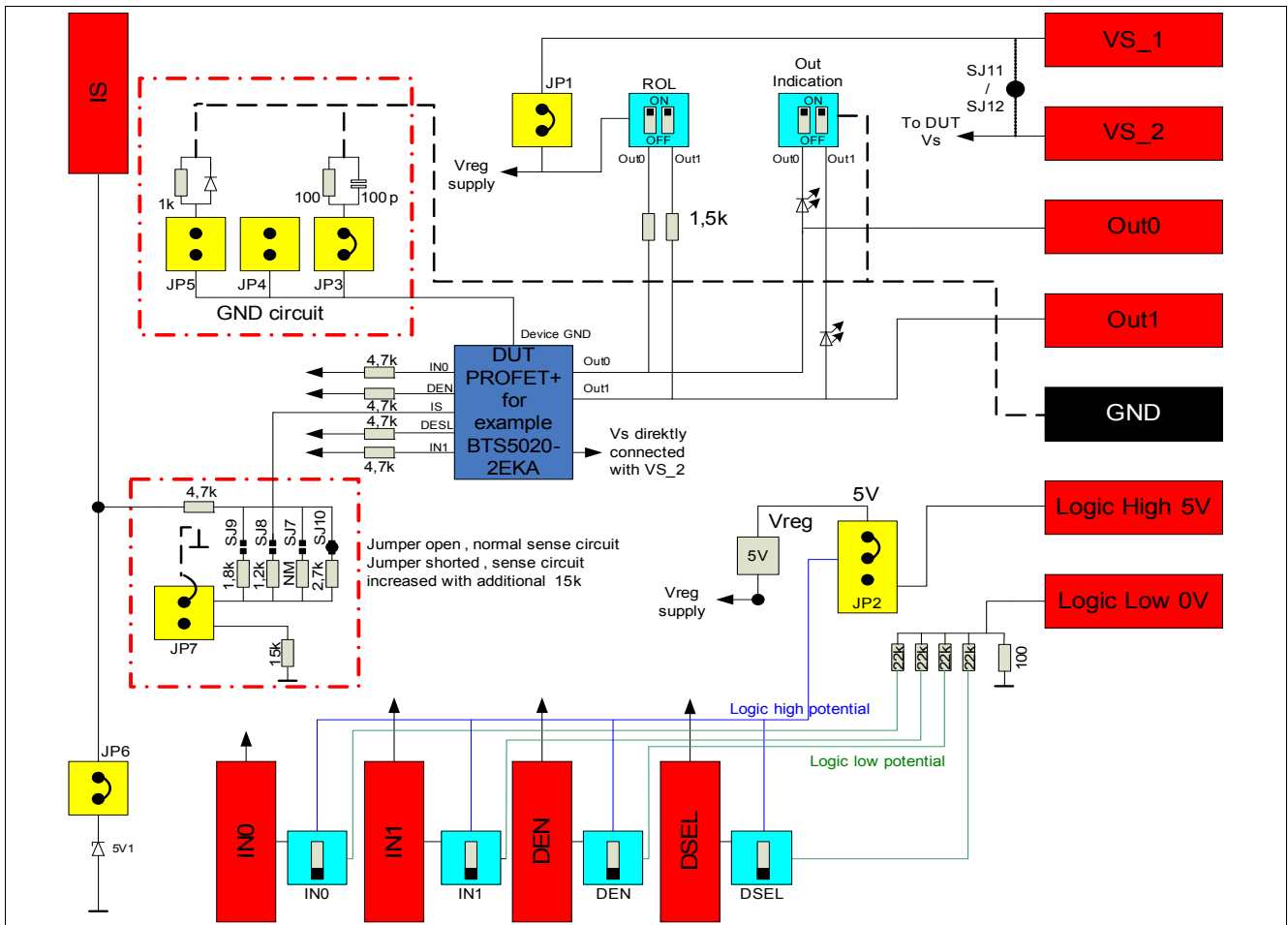

**Figure 1 Block Diagram of the PROFET+ Demoboard**

The PROFET™+ can be controlled with either the internal or external signals on the banana connectors. For (IN0, IN1, DEN, DSEL) external signal control the respective connector has to be turned off with the respective switch on the demoboard. If the switch is turned on and there is an external signal, this signal is shorted with the internal 5V or the external High logic 5V.

Connector	Function
VS_1	Connection for the supply of the µC-board and the internal 5V supply
VS_2	Connection of the power line Vs for the PROFET™+ DUT. It is usually connected with VS_1 on the backside of the board via SJ11 and SJ12
OUT0	Out0 from the PROFET™+, for one channel devices the single output
OUT1	Out1 from the two channel PROFET™+, for one channel devices this out is not used
GND	Connection for the module GND, the device GND can be chosen with JP3 or JP5
Logic High 5V	With these connectors it's possible to control the logical high / low voltage level with an external supply
Logic Low 0V	

### 3 Demoboard Description

Note: The following information is given as a hint for the implementation of the device only and shall not be regarded as a description or warranty of a certain functionality, condition or quality of the device.

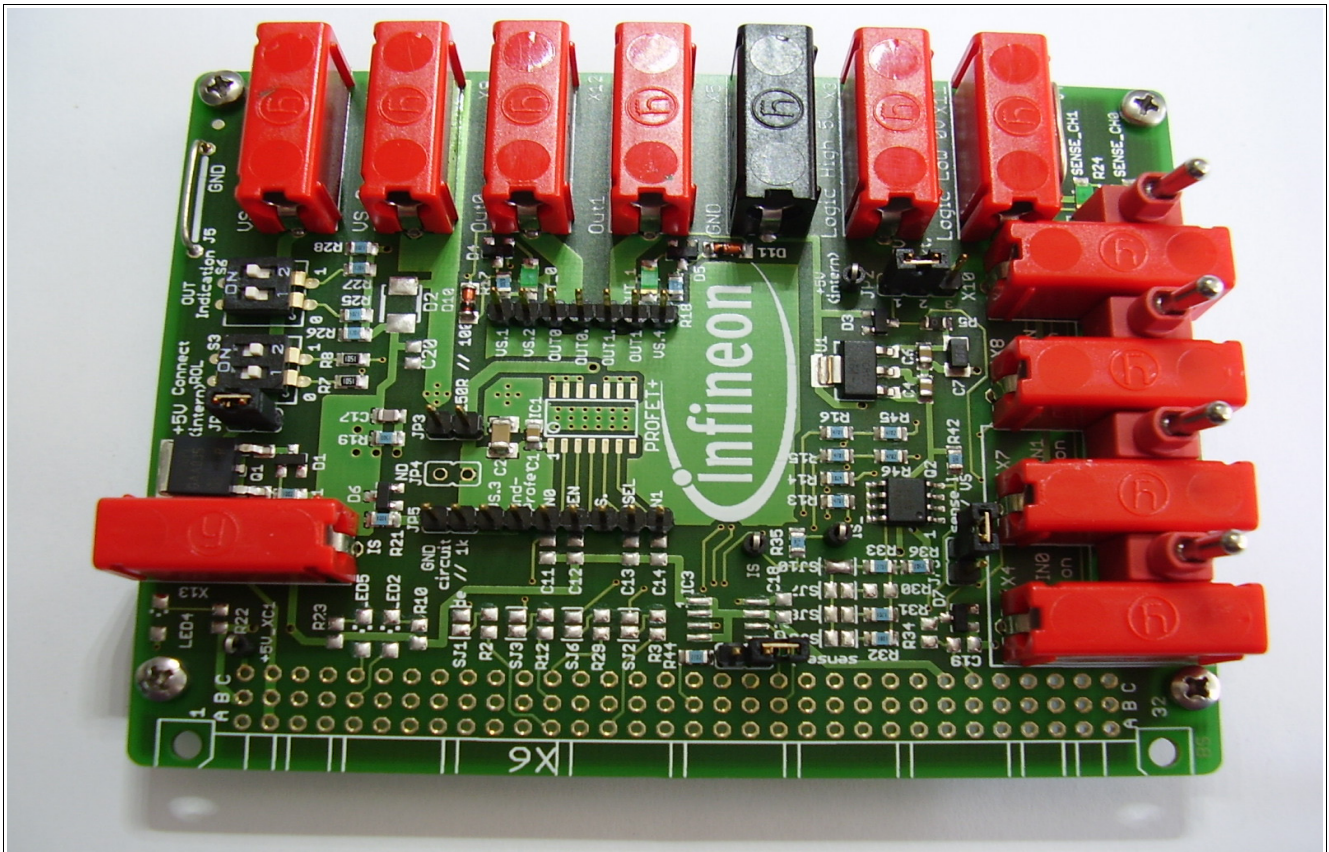

Figure 2 Motherboard of PROFET+ demoboard

The picture shows the motherboard of the PROFET+ demoboard. Starting from the banana connectors at the top of the figure going in a clockwise direction:

- VS\_1...Connection of Vbat to the Demoboard and also for the internal 5V generation. There are two soldering jumpers at the bottom side of the motherboard to connect VS\_1 with VS\_2 (SJ11, SJ12).
- VS\_2...Connection of Vbat to the PROFET+ VS pin.
- Out0...Output 0 of the PROFET+ (for one channel devices the only output)
- Out1...Output 1 of the two channel PROFET+, if a one channel device is used this output is not active.
- GND...The GND of the demoboard, device ground connection can be chosen with JP3 or JP5.
- Logic High 5V...At this pin the logical high voltage which is forced to the logical pins of the PROFET+ could be controlled from an external supply. Only applicable with the switches at the right side on the motherboard. The JP2 has to short point 2 and 3 to activate the external voltage. If JP2 shorts 1 and 2 the internal 5V is used (see [Figure 4](#)).
- Logic Low 0V...At this pin the logical low voltage which is forced to the logical pins of the PROFET+ could be controlled from an external supply. Is only valid with the usage of the switches on the demoboard.
- DSEL... Banana connector for external connection to choose the sense signal of Channel 0 or Channel 1, also can be controlled internally on the board with the switch on the board.



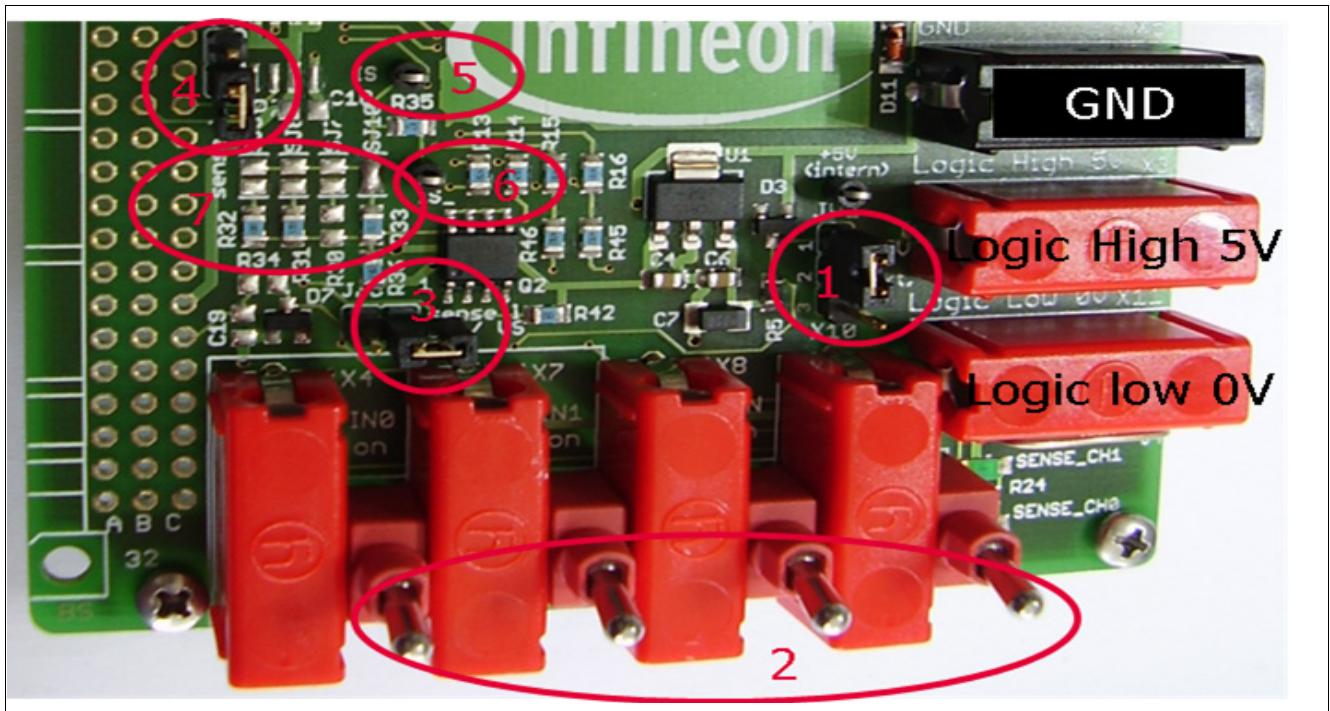
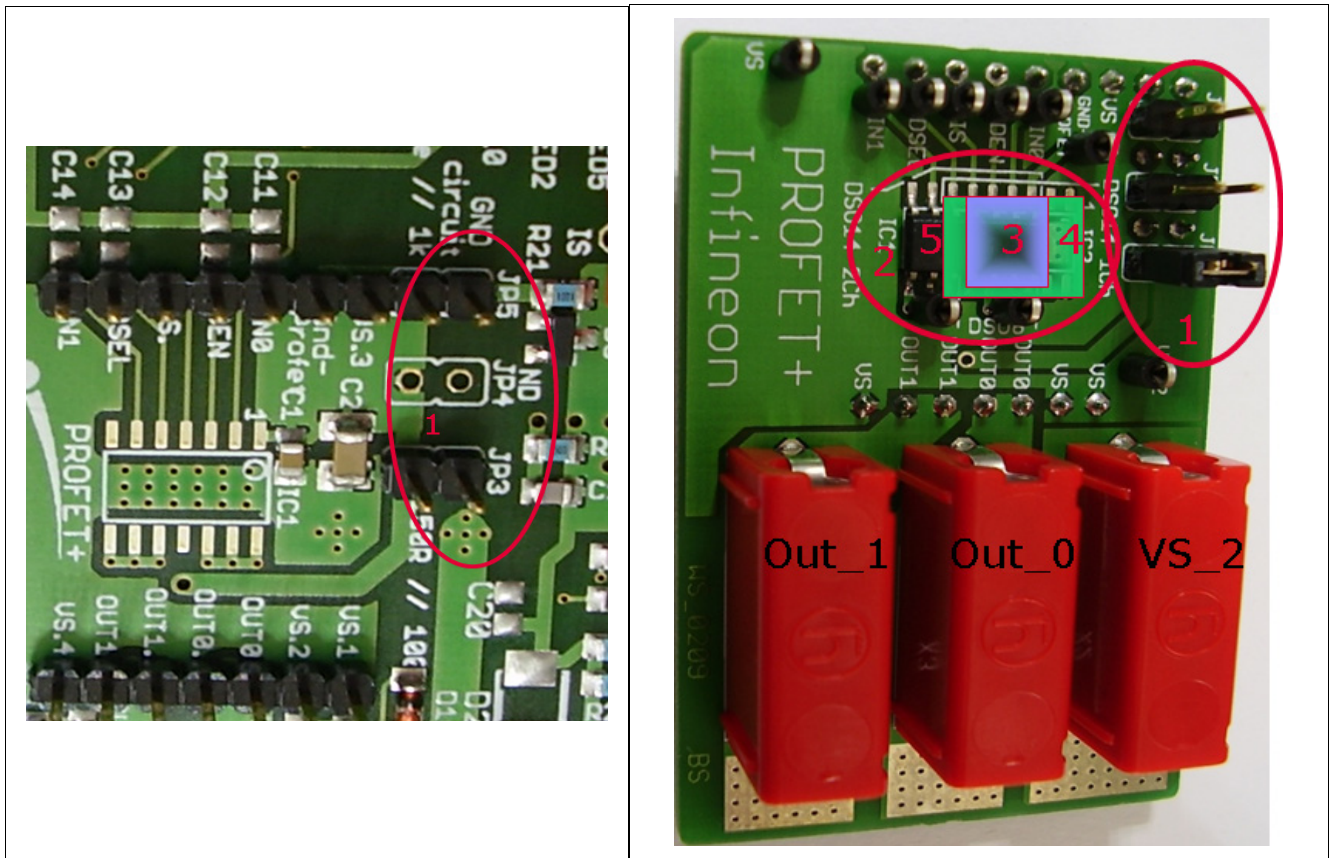

Figure 4 Application Diagram

1. JP2... With Jumper 2 the internal 5V or the external Logic High 5V connection for the logic High signal can be chosen. Applicable with the switches on the motherboard, if an external signal generator is used the respective voltage is forced to the device pins IN0, IN1, DEN, DSEL.
2. IN0, IN1, DEN, DSEL... Logic signals to control the PROFET+ device. To control the Profet+ with external signals the switch for the respective connector must be OFF.
3. JP6... With setting this jumper the voltage limit of the  $I_{IS}$  signal is set to 5.1V at the IS\_ pin (6) and the banana connector at IS.
4. JP7... When this jumper is shorted, the sense resistance is increased with additional 15kOhm. This jumper is linked to a MOSFET which shorts the 15k resistance when the jumper is open. The additional 15k resistor is helpful for measuring very low currents.
5. IS... This is the direct  $I_{IS}$  signal from the device.
6. IS\_... The limited  $I_{IS}$  signal, with the additional serial resistor and the limited voltage, if JP6 is set.
7. R30..SJ7, R31..SJ8, R32..SJ9, R33..SJ10... With the soldering jumpers SJ7-SJ10 the sense resistor can be easily chosen. As standard SJ10 is connected (sense resistance = 2.7kOhm)



**Figure 5 Part of the motherboard / daughter board (adapter)**

If high inrush currents are expected the connectors Out0, Out1, and VS\_2 on the daughter board should be used to reduce resistance on the board. For very low ohmic connections the test wires could be directly soldered of the daughter board.

1. JP3, JP5: GND circuit of PROFET+ device... The ground circuit of this device can be chosen with JP3 and JP5. JP3 is a ground resistor with 150Ohm and 100pF in parallel to R<sub>gnd</sub>. JP4 is a direct connection to module GND, this is not connected on the standard boards to avoid a destruction of the device due to misuse. JP5 is a ground circuit with a diode and 1kOhm in parallel to this. Jumpers are available on both the motherboard and daughter board.
2. The daughter board layout is capable hold a DSO 14 and DSO 8 device. This opens the opportunity to solder every 1- and 2-channel Profet+ device on the same PCB.
3. Pin-compatibility of PROFET+ family... PG-DSO8 for one channel devices placement.
4. Pin-compatibility of PROFET+ family... PG-DSO14 for one channel devices placement.
5. Pin-compatibility of PROFET+ family... PG-DSO14 for two channel devices placement.



# 4 Schematic

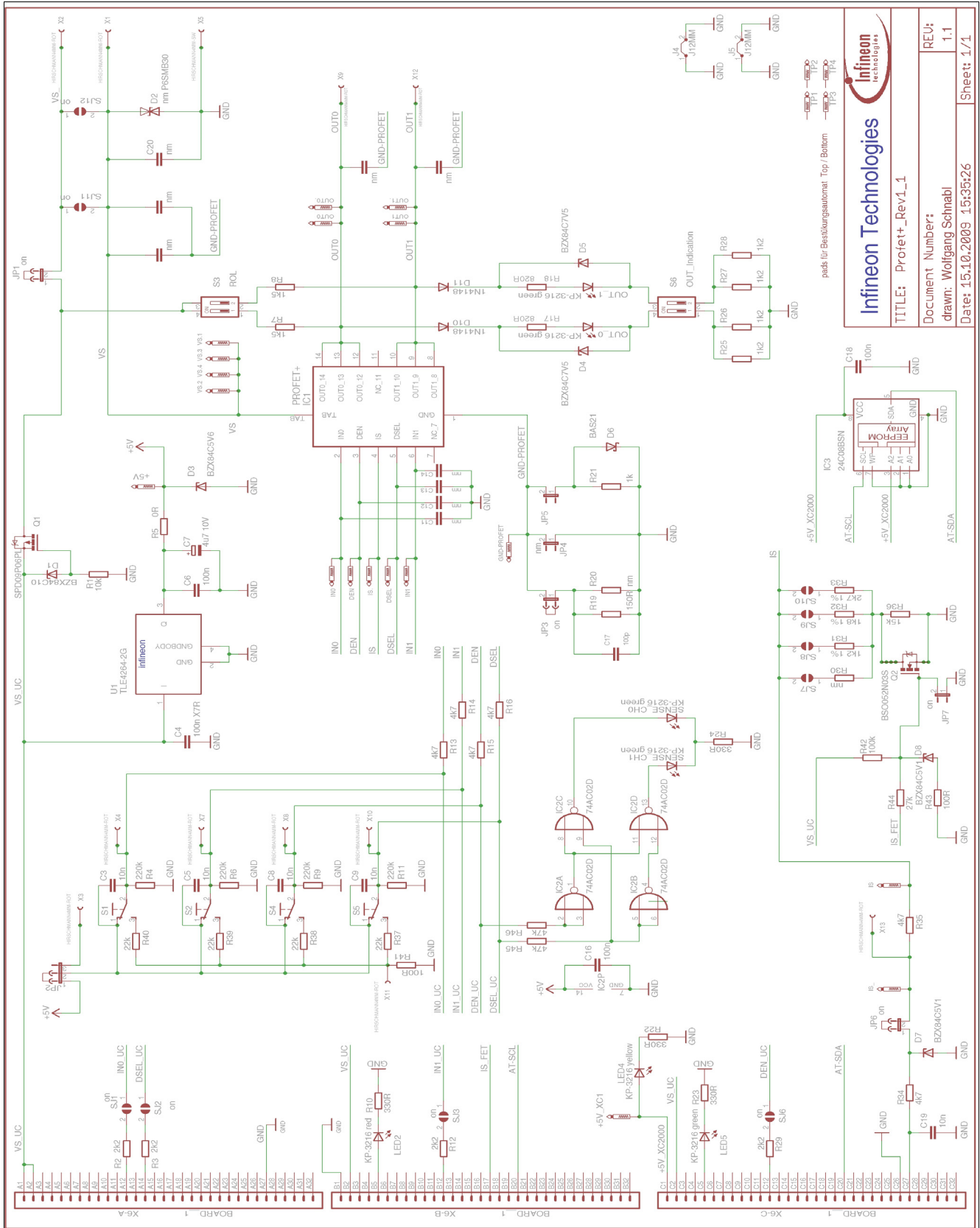

**Infineon Technologies**  
Infineon Technologies logo

TITLE: Profet+\_Rev1.1

Document Number: 1.1

drawn: Wolfgang Schmalb

Date: 15.10.2009 15:35:26

Sheet: 1/1

Figure 6 Block Diagram

## 5 PCB drawings

### 5.1 Top side

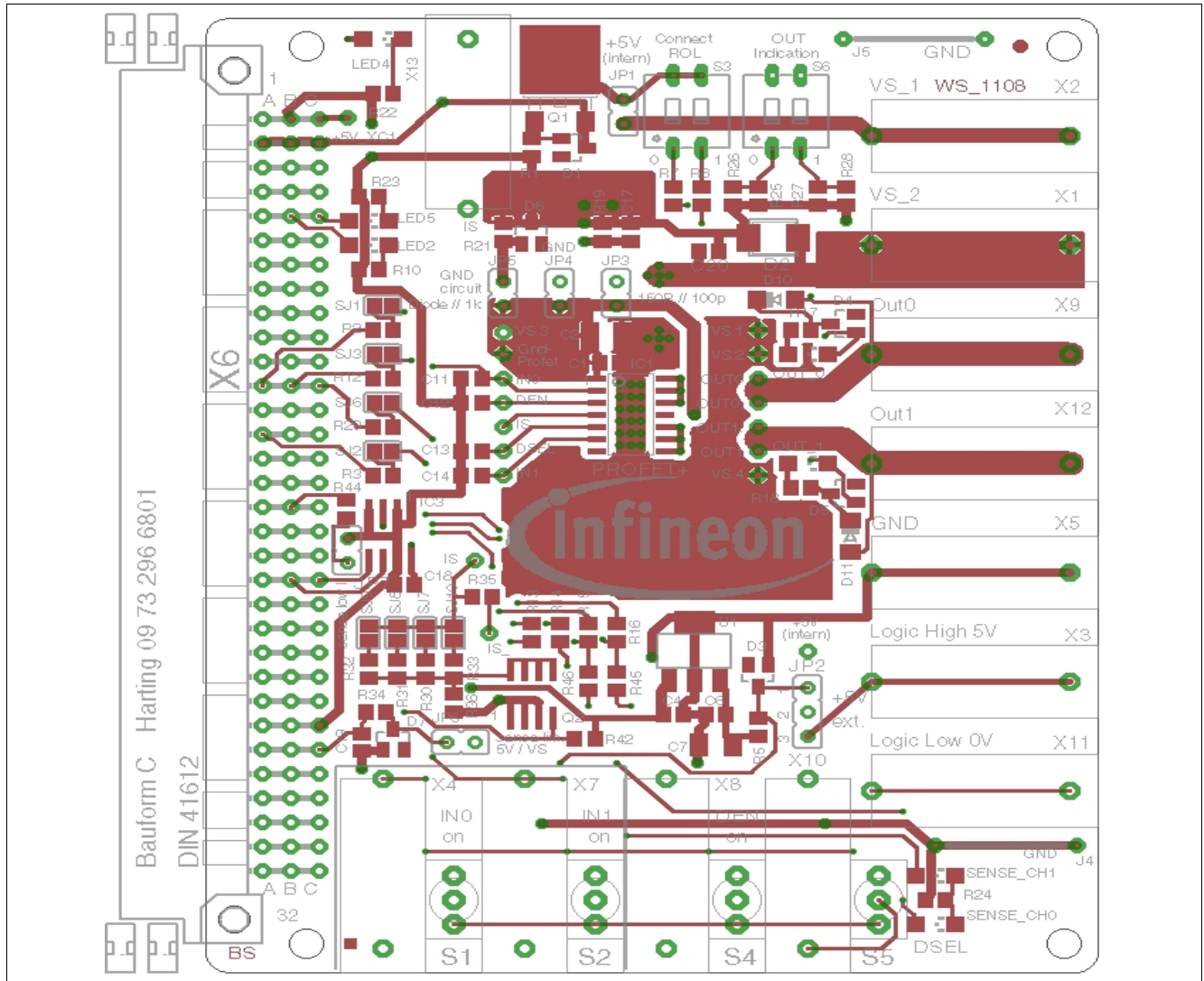

Figure 7 Block Diagram

5.2 Bottom side

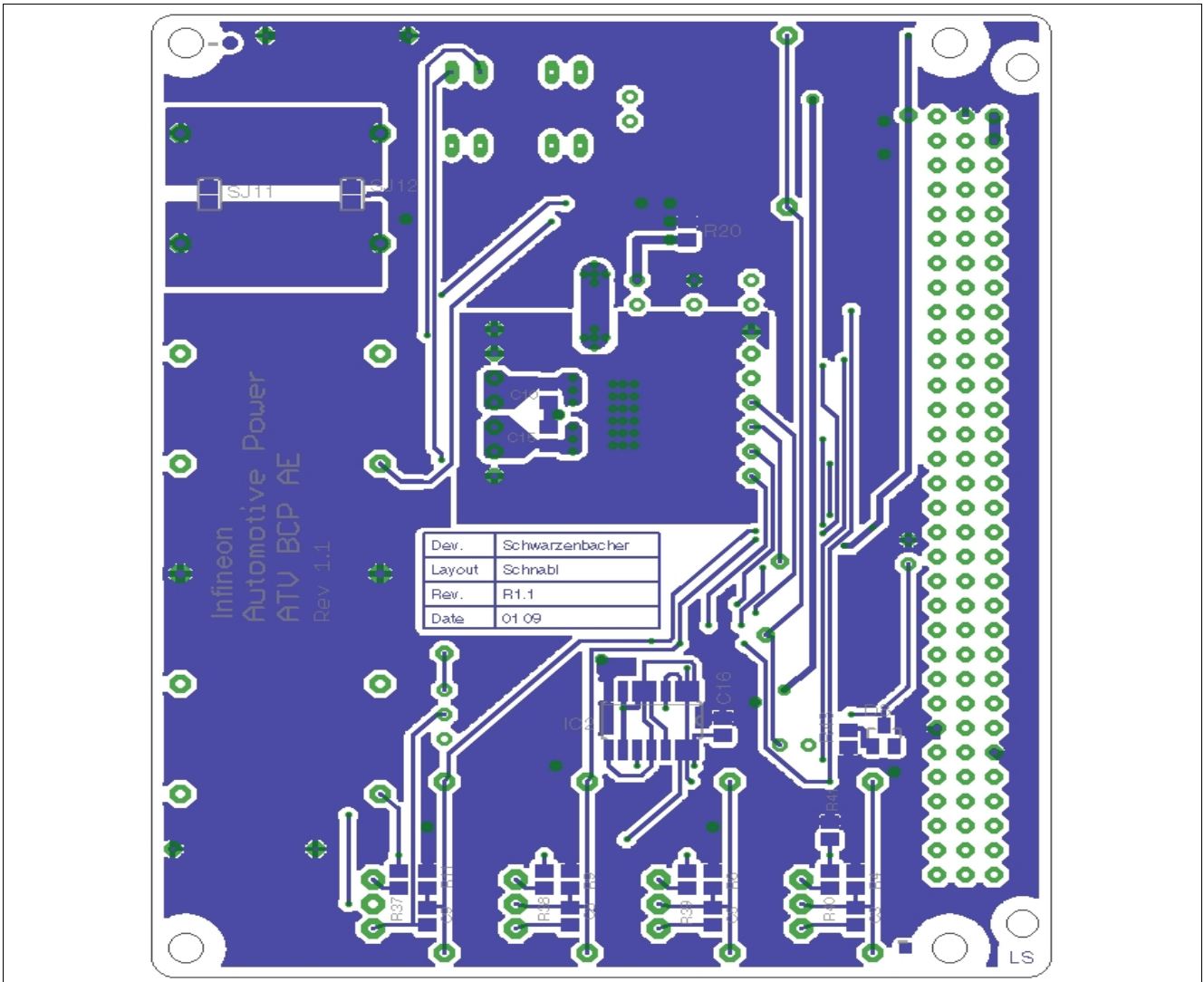

Figure 8 Block Diagram

## 6 Revision History

Revision	Date	Changes
1.0	2009-08-18	Creation of document
1.1	2009-10-06	Minor changes to the description on page 3, page 4. Change of heading "4 Detailed information to the demoboard" to "3.1 Detailed information to the demoboard"
1.2	2009-10-28	Minor changes of the description.
1.3	2010-08-25	Minor changes of the description
1.4	2011-02-16	added guideline for HV product usage; Chaper 3.1

**Edition 2011-02-16**

**Published by  
Infineon Technologies AG  
81726 Munich, Germany**

**© 2011 Infineon Technologies AG  
All Rights Reserved.**

### **Legal Disclaimer**

The information given in this document shall in no event be regarded as a guarantee of conditions or characteristics. With respect to any examples or hints given herein, any typical values stated herein and/or any information regarding the application of the device, Infineon Technologies hereby disclaims any and all warranties and liabilities of any kind, including without limitation, warranties of non-infringement of intellectual property rights of any third party.

### **Information**

For further information on technology, delivery terms and conditions and prices, please contact the nearest Infineon Technologies Office ([www.infineon.com](http://www.infineon.com)).

### **Warnings**

Due to technical requirements, components may contain dangerous substances. For information on the types in question, please contact the nearest Infineon Technologies Office.

Infineon Technologies components may be used in life-support devices or systems only with the express written approval of Infineon Technologies, if a failure of such components can reasonably be expected to cause the failure of that life-support device or system or to affect the safety or effectiveness of that device or system. Life support devices or systems are intended to be implanted in the human body or to support and/or maintain and sustain and/or protect human life. If they fail, it is reasonable to assume that the health of the user or other persons may be endangered.

## X-ON Electronics

Largest Supplier of Electrical and Electronic Components

*Click to view similar products for [Power Management IC Development Tools](#) category:*

*Click to view products by [Infineon](#) manufacturer:*

Other Similar products are found below :

[EVB-EP5348UI](#) [MIC23451-AAAYFL EV](#) [MIC5281YMME EV](#) [124352-HMC860LP3E](#) [DA9063-EVAL](#) [ADP122-3.3-EVALZ](#) [ADP130-0.8-EVALZ](#) [ADP130-1.8-EVALZ](#) [ADP1740-1.5-EVALZ](#) [ADP1870-0.3-EVALZ](#) [ADP1874-0.3-EVALZ](#) [ADP199CB-EVALZ](#) [ADP2102-1.25-EVALZ](#) [ADP2102-1.875EVALZ](#) [ADP2102-1.8-EVALZ](#) [ADP2102-2-EVALZ](#) [ADP2102-3-EVALZ](#) [ADP2102-4-EVALZ](#) [AS3606-DB](#) [BQ25010EVM](#) [BQ3055EVM](#) [ISLUSBI2CKIT1Z](#) [LM2734YEVAL](#) [LP38512TS-1.8EV](#) [EVAL-ADM1186-1MBZ](#) [EVAL-ADM1186-2MBZ](#) [ADP122UJZ-REDYKIT](#) [ADP166Z-REDYKIT](#) [ADP170-1.8-EVALZ](#) [ADP171-EVALZ](#) [ADP1853-EVALZ](#) [ADP1873-0.3-EVALZ](#) [ADP198CP-EVALZ](#) [ADP2102-1.0-EVALZ](#) [ADP2102-1-EVALZ](#) [ADP2107-1.8-EVALZ](#) [ADP5020CP-EVALZ](#) [CC-ACC-DBMX-51](#) [ATPL230A-EK](#) [MIC23250-S4YMT EV](#) [MIC26603YJL EV](#) [MIC33050-SYHL EV](#) [TPS60100EVM-131](#) [TPS65010EVM-230](#) [TPS71933-28EVM-213](#) [TPS72728YFFEVM-407](#) [TPS79318YEQEV](#) [UCC28810EVM-002](#) [XILINXPWR-083](#) [LMR22007YMINI-EVM](#)