

BTN9960/BTN9970/BTN9990 Motor control shield

Arduino shield for evaluation

About this document

Scope and purpose

This document describes the usage of the motor control shields for BTN9960/BTN9970/BTN9990.

Evaluation board	Comment	Board marking
DC-Shield_BTN9970LV	Contains 1 x BTN9970LV and 1 x BTN9990LV	BTN99xx NovalithIC+ 1.2
DC-Shield_BTN9960LV	Contains 2 x BTN9960LV	BTN99xx NovalithIC+ 2.0

The boards can be connected to an Arduino UNO board or controlled via a PC with the config wizard for MOTIX™ single half-bridges IC's and an μ IO-Stick.

Intended audience

This document is intended for electronic engineers who want to evaluate a high current PMOS/NMOS half bridge with integrated driver.

Evaluation board

This board can be used during design in phase for customer projects, for evaluation and measurement of BTN9960/BTN9970/BTN9990 device behavior.

PCB and auxiliary circuits are not optimized for final customer design.

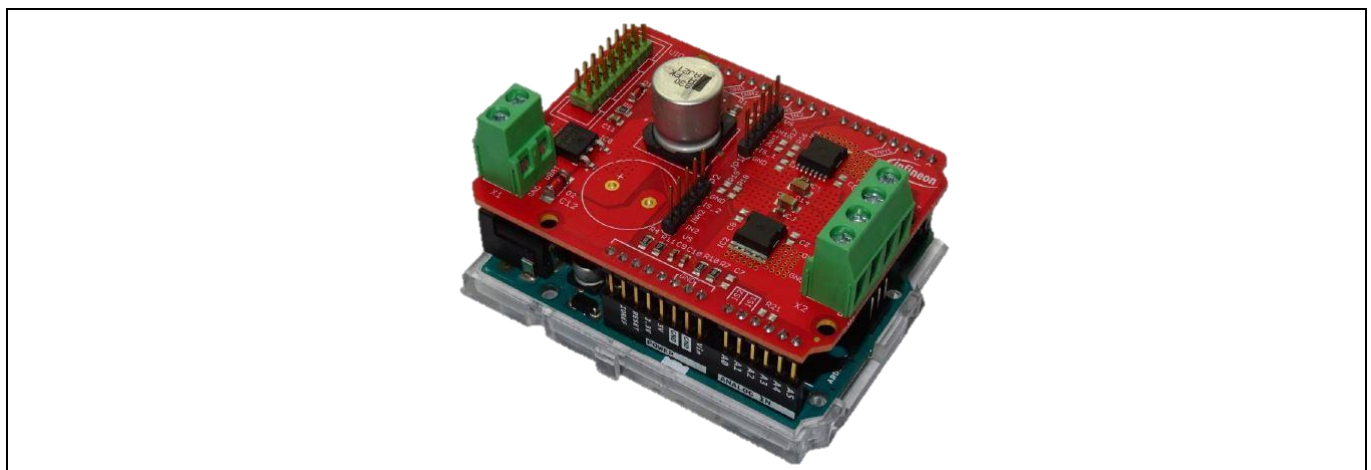

Figure 1 BTN9960/BTN9970/BTN9990 motor control shield stacked on Arduino UNO board

Important notice

Important notice

"Evaluation boards and reference boards" mean products embedded on a printed circuit board (PCB) for demonstration and/or evaluation purposes, which include, without limitation, demonstration, reference and evaluation boards, kits and design (collectively referred to as "reference board").

Environmental conditions have been considered in the design of the evaluation boards and reference boards provided by Infineon Technologies. The design of the evaluation boards and reference boards has been tested by Infineon Technologies only as described in this document. The design is not qualified in terms of safety requirements, manufacturing and operation over the entire operating temperature range or lifetime.

The evaluation boards and reference boards provided by Infineon Technologies are subject to functional testing only under typical load conditions. Evaluation boards and reference boards are not subject to the same procedures as regular products regarding returned material analysis (RMA), process change notification (PCN) and product discontinuation (PD).

Evaluation boards and reference boards are not commercialized products, and are solely intended for evaluation and testing purposes. In particular, they may not be used for reliability testing or production. The evaluation boards and reference boards may therefore not comply with CE or similar standards (including but not limited to the EMC Directive 2004/EC/108 and the EMC Act) and may not fulfill other requirements of the country in which they are operated by the customer. The customer must ensure that all evaluation boards and reference boards will be handled in a way which is compliant with the relevant requirements and standards of the country in which they are operated.

The evaluation boards and reference boards as well as the information provided in this document are addressed only to qualified and skilled technical staff, for laboratory usage, and must be used and managed according to the terms and conditions set forth in this document and in other related documentation supplied with the respective evaluation board and reference board.

It is the responsibility of the customer's technical departments to evaluate the suitability of the evaluation boards and reference boards for the intended application, and to evaluate the completeness and correctness of the information provided in this document with respect to such application.

The customer is obliged to ensure that the use of the evaluation boards and reference boards does not cause any harm to persons or third-party property.

The evaluation boards and reference boards and any information in this document is provided "as is" and Infineon Technologies disclaims any warranties, express or implied, including but not limited to warranties of non-infringement of third-party rights and implied warranties of fitness for any purpose, or for merchantability.

Infineon Technologies may not be responsible for any damages resulting from the use of the evaluation boards and reference boards and/or from any information provided in this document. The customer is obliged to defend, indemnify and hold Infineon Technologies harmless from and against any claims or damages arising out of or resulting from any use thereof.





Infineon Technologies reserves the right to modify this document and/or any information provided herein at any time without further notice.

Safety precautions

Safety precautions

Note: Please note the following warnings regarding the hazards associated with development systems.

Table 1 Safety precautions

	Caution
	The heat sink and device surfaces of the evaluation or reference board may become hot during testing. Hence, necessary precautions are required while handling the board. Failure to comply may cause injury.
	Only personnel familiar with the drive, power electronics and associated machinery should plan, install, commission and subsequently service the system. Failure to comply may result in personal injury and/or equipment damage.
	The evaluation or reference board contains parts and assemblies sensitive to electrostatic discharge (ESD). Electrostatic control precautions are required when installing, testing, servicing or repairing the assembly. Component damage may result if ESD control procedures are not followed. If you are not familiar with electrostatic control procedures, refer to the applicable ESD protection handbooks and guidelines.
	A drive that is incorrectly applied or installed can lead to component damage or reduction in product lifetime. Wiring or application errors such as undersizing the motor, supplying an incorrect or inadequate AC supply, or excessive ambient temperatures may result in system malfunction.

Warnings

Due to technical requirements products may contain dangerous substances. For information on the types in question please contact your nearest Infineon Technologies office.

Except as otherwise explicitly approved by Infineon Technologies in a written document signed by authorized representatives of Infineon Technologies, Infineon Technologies’ products may not be used in any applications where a failure of the product or any consequences of the use thereof can reasonably be expected to result in personal injury.

Table of contents

About this document	1
Important notice	2
Safety precautions	3
Warnings	3
Table of contents	4
1 The board at a glance	5
1.1 Delivery content	5
1.2 Block diagram.....	5
1.3 Main features	6
2 Hardware description	7
2.1 Differences between boards	7
2.2 Board overview and connectors	7
2.3 BTN99xx pin assignment, definition and functions	8
3 Getting started	8
3.1 Arduino Uno controller board or compatible boards	8
3.2 Config Wizard for MOTIX™ single half-bridge ICs	9
4 Board design	10
4.1 Schematics	10
4.2 Layout	12
4.3 Bill of material	16
5 References and appendices	21
5.1 Abbreviations and definitions.....	21
5.2 References	21
6 Revision history	22

1 The board at a glance

1.1 Delivery content

The carton box includes either one DC-Shield_BTN9970LV or one DC-Shield_BTN9960LV board.

The Arduino UNO board and a power supply are not included. Information about the Arduino controller board can be found under: [Arduino - Home](#).

1.2 Block diagram

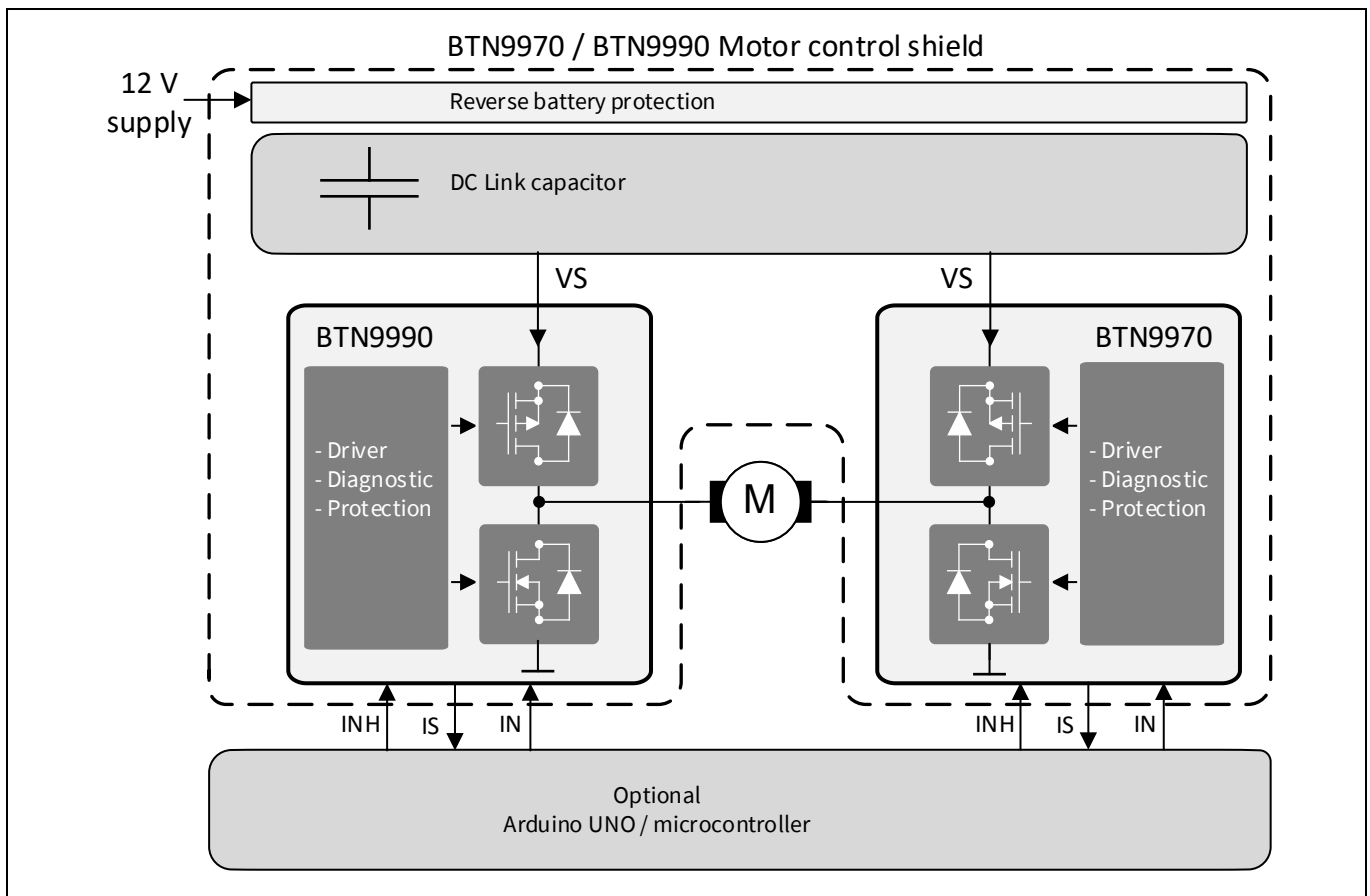

Figure 2 Block diagram DC-Shield_BTN9970LV

The board at a glance

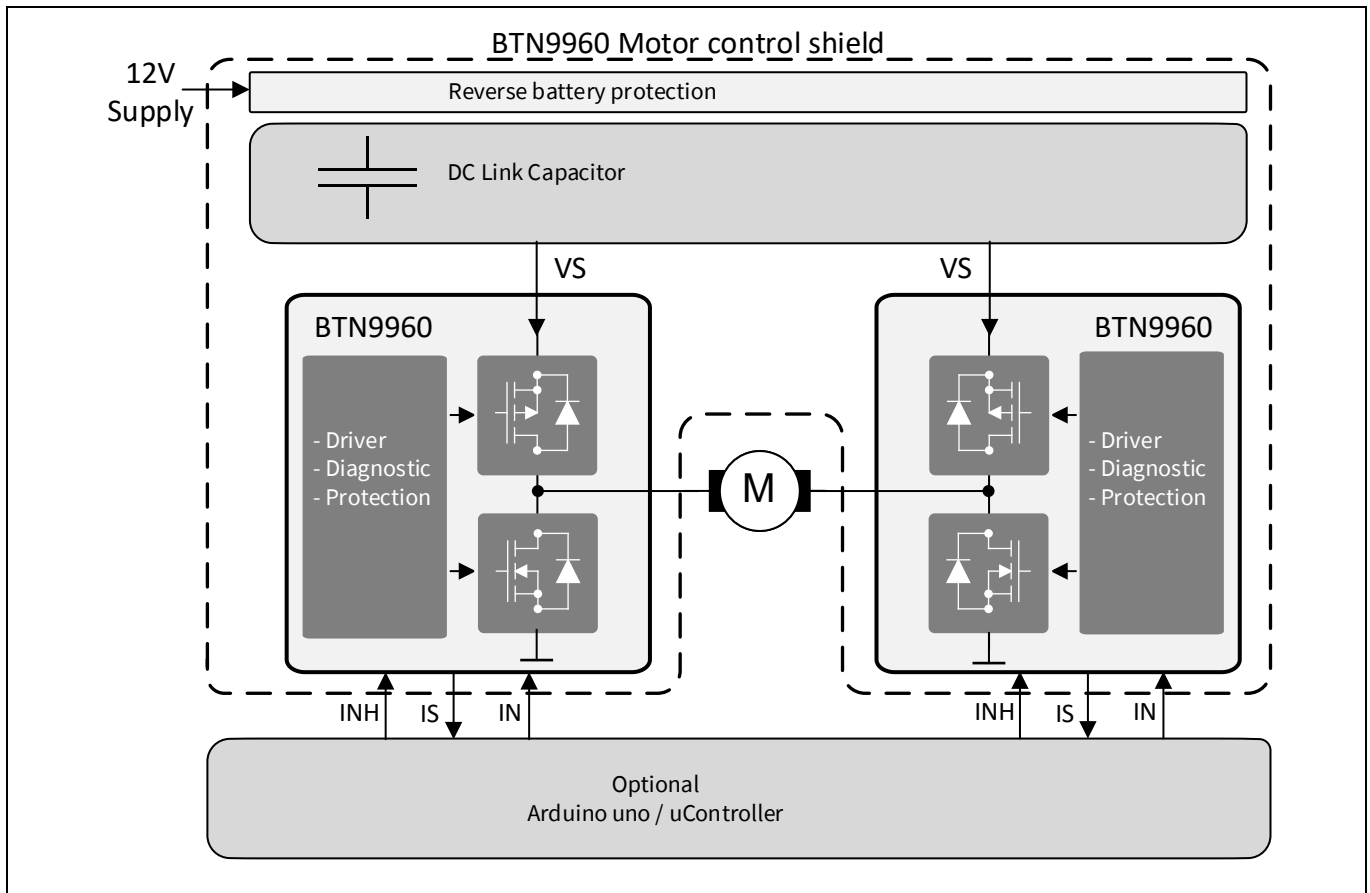

Figure 3 Block diagram DC-Shield_BTN9960LV

1.3 Main features

The boards include two BTN99xx high current half bridges with integrated driver IC

The board features:

- Operating voltage: 8 V – 18V
- Average motor current up to ~ 10 A. Restricted by the value and size of DC-link capacitor and power dissipation of PCB (current limitation of BTN9960LV is min. 35 A, BTN9970LV is min. 60 A and for BTN9990 min. 75 A)
- Two independent single half-bridges to operate two DC brushed motors unidirectionally either in motor to GND or motor to V_s configuration
- Single H (full) bridge to operate a DC brush motor bidirectionally. In his case, the motor needs to be connected between the outputs OUT1 and OUT2
- A 16-pin connector to interface via a μ O-Stick to a PC or notebook with installed Infineon's Toolbox software
- Connectors to stack the motor control shield directly on top of an Arduino UNO controller board
- PWM operation, controlled by Arduino UNO board
- Reverse polarity protection by IC0 (PMOS transistor)

2 Hardware description

2.1 Differences between boards

Rev.	Board name	Components	Layout
1.2	DC-Shield_BTN9970LV	1 x BTN9970LV, 1 x BTN9990LV, R4/R7 (R _{IS}) = 2 kΩ, C9/C10 (C _{IS}) = 1 nF	
2.0	DC-Shield_BTN9960LV	2 x BTN9960LV, R4/R7 (R _{IS}) = 1.8 kΩ, C9 / C10 (C _{IS}) = 220 pF	Moved position of IC1/IC2 to have more copper area around the IC's. Thicker restrings of vias to increase copper content

2.2 Board overview and connectors

Figure 4 below describes the motor control shield with its connectors. It applies for both board revision DC-Shield_BTN9970LV and DC-Shield_BTN9960LV.

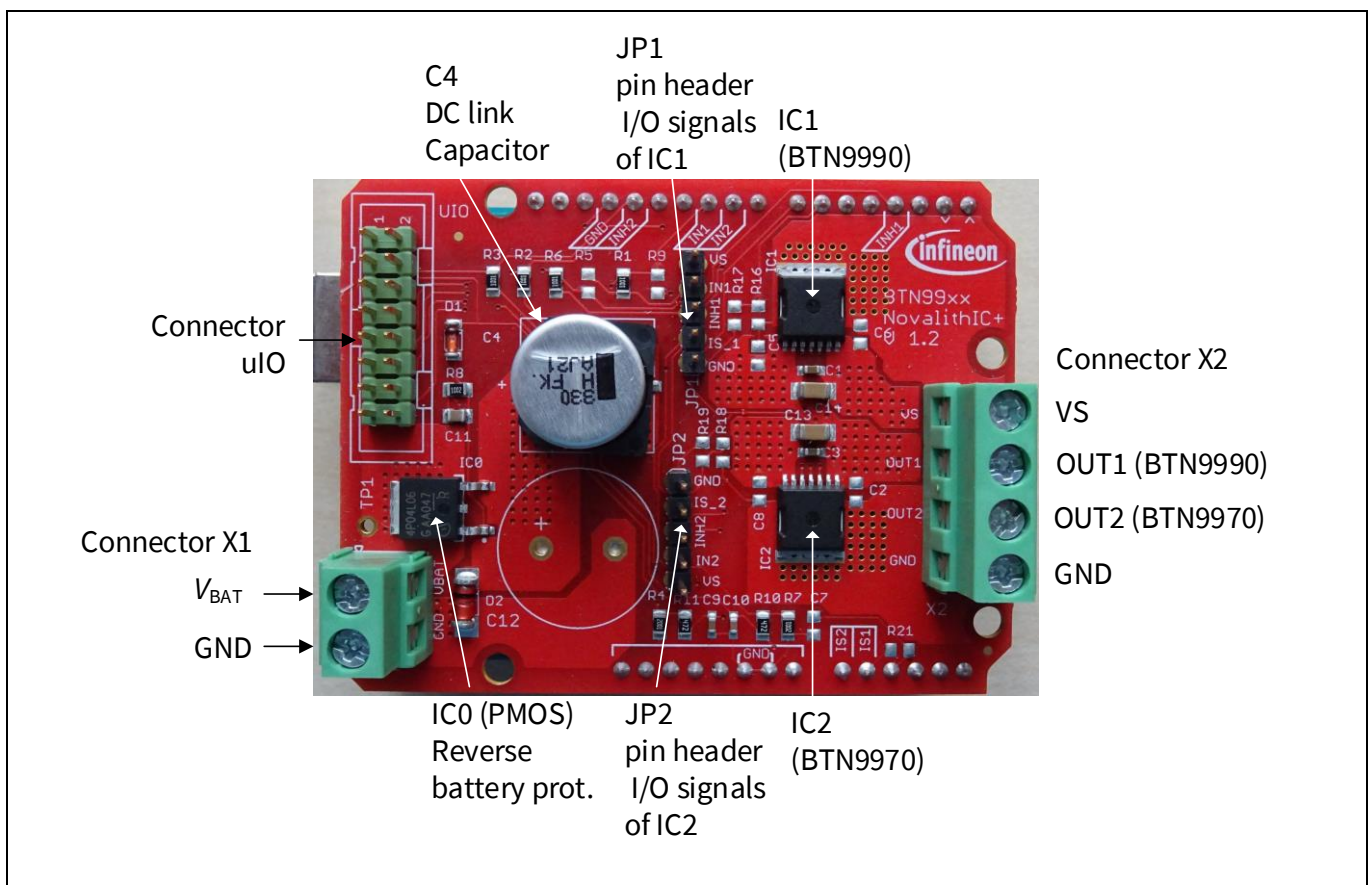

Figure 4 Board top view with connectors

2.3 BTN99xx pin assignment, definition and functions

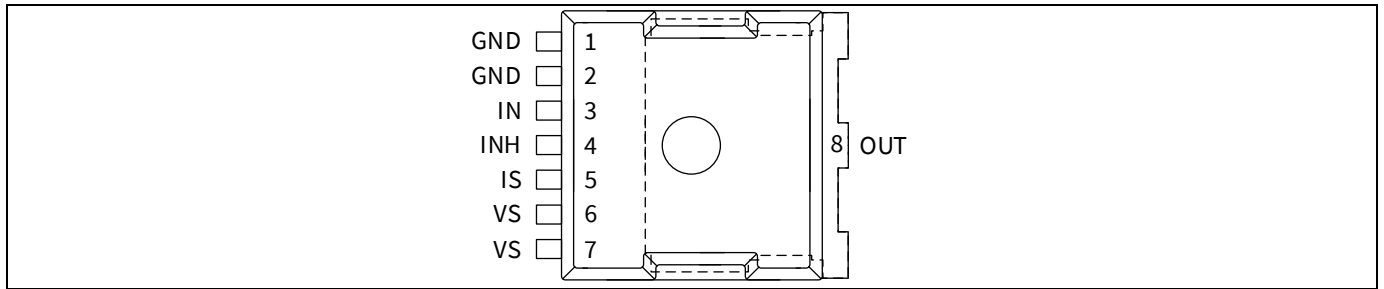

Figure 5 Pin assignment BTN99xxLV top view

Table 1: Pin definitions and functions

Pin	Symbol	I/O	Function
1,2	GND	-	Ground 1)
3	IN	I	Input Defines whether high- or low-side switch is activated An internal pull-down resistor is connected to this pin
4	INH	I	Inhibit When set to low device goes in tristate An internal pull-down resistor is connected to this pin
5	IS	O	Current sense, temperature sense, slew rate level and diagnostics
6,7	VS	-	Supply 1)
8(EP)	OUT	O	Power output of the bridge

1) All terminal pins must be connected together on the PCB. All terminal pins are internally connected together. PCB traces have to be designed to withstand the maximum current which can flow

Bold type: pin needs power wiring

3 Getting started

There are two options to operate the boards:

- Stacked on an Arduino Uno (REV3) board or compatible.
- Config Wizard for MOTIX™ single half-bridge IC's. This is a software tool running on a PC or laptop and providing a GUI to control the BTN99xxLV on the boards. To interface the boards to the USB port of the PC or laptop a µIO-Stick is necessary.

3.1 Arduino Uno controller board or compatible boards

Infineon offers BTN99xxLV device driver to provide a simple API (application programming interface) to configure the devices.

BTN99xxLV device driver can be found on the webpage of the device:

Getting started

<https://www.infineon.com/cms/en/product/power/motor-control-ics/brushed-dc-motor-control-ics/single-half-bridge-ics/btn9970lv/>

Example codes to operate with an Arduino Uno board can be found on the webpage:

<https://github.com/Infineon/arduino-examples-btn9990-9970-dc-motor-control-shield>

3.2 Config Wizard for MOTIX™ single half-bridge ICs

The Config Wizard for MOTIX™ single half-bridge ICs provides a GUI to control the board via a PC. The tool is integrated in the Infineon developer center, see Figure 6. To operate the board via the Config Wizard for MOTIX™ single half-bridge ICs a μ IO-Stick is needed to interface to the USB port of the PC or laptop, see Figure 7. More information and download of the Config Wizard for MOTIX™ single half-bridge ICs can be found on the device web page <https://www.infineon.com/cms/en/product/power/motor-control-ics/brushed-dc-motor-control-ics/single-half-bridge-ics/btn9970lv/>.

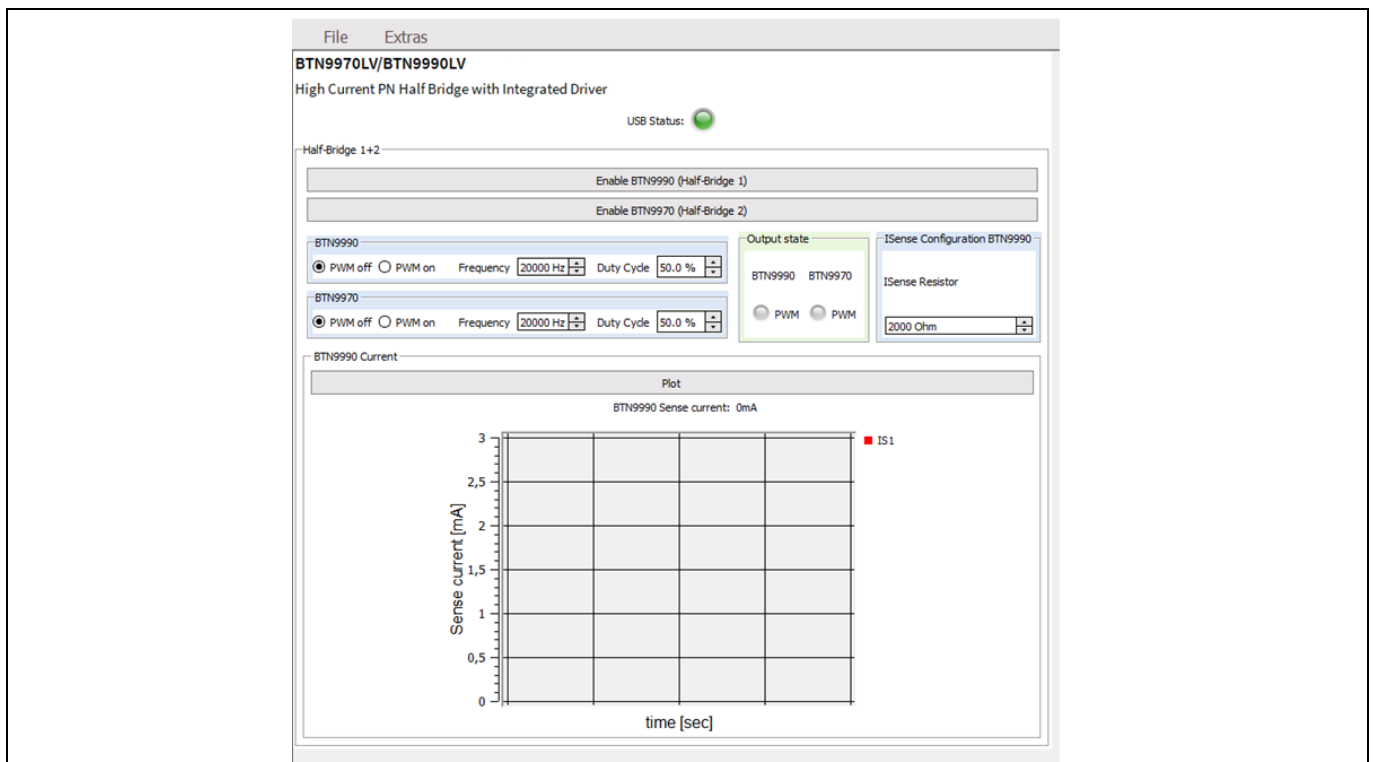

Figure 6 GUI of the Config Wizard for MOTIX™ single half-bridge ICs

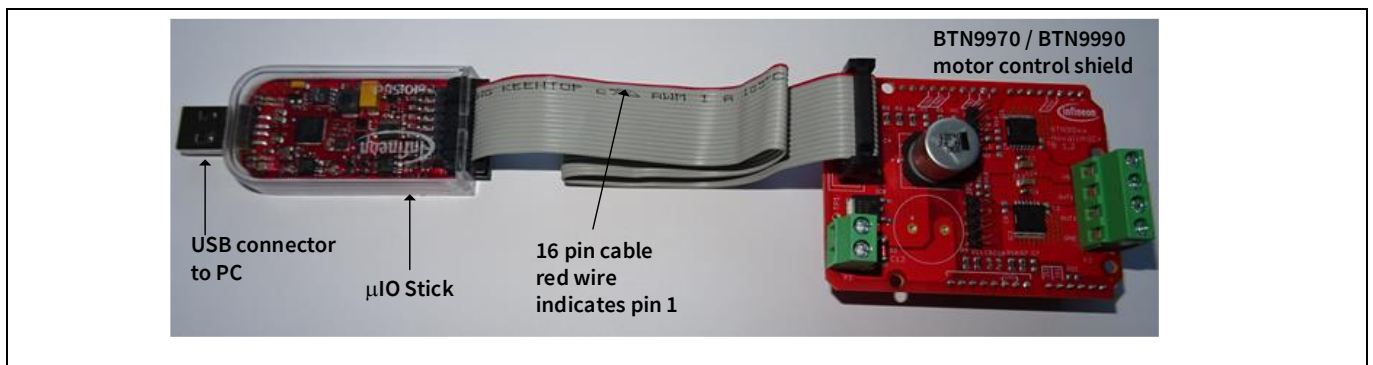

Figure 7 DC-Shield_BTN9970LV with μ IO-Stick

4 Board design

4.1 Schematics

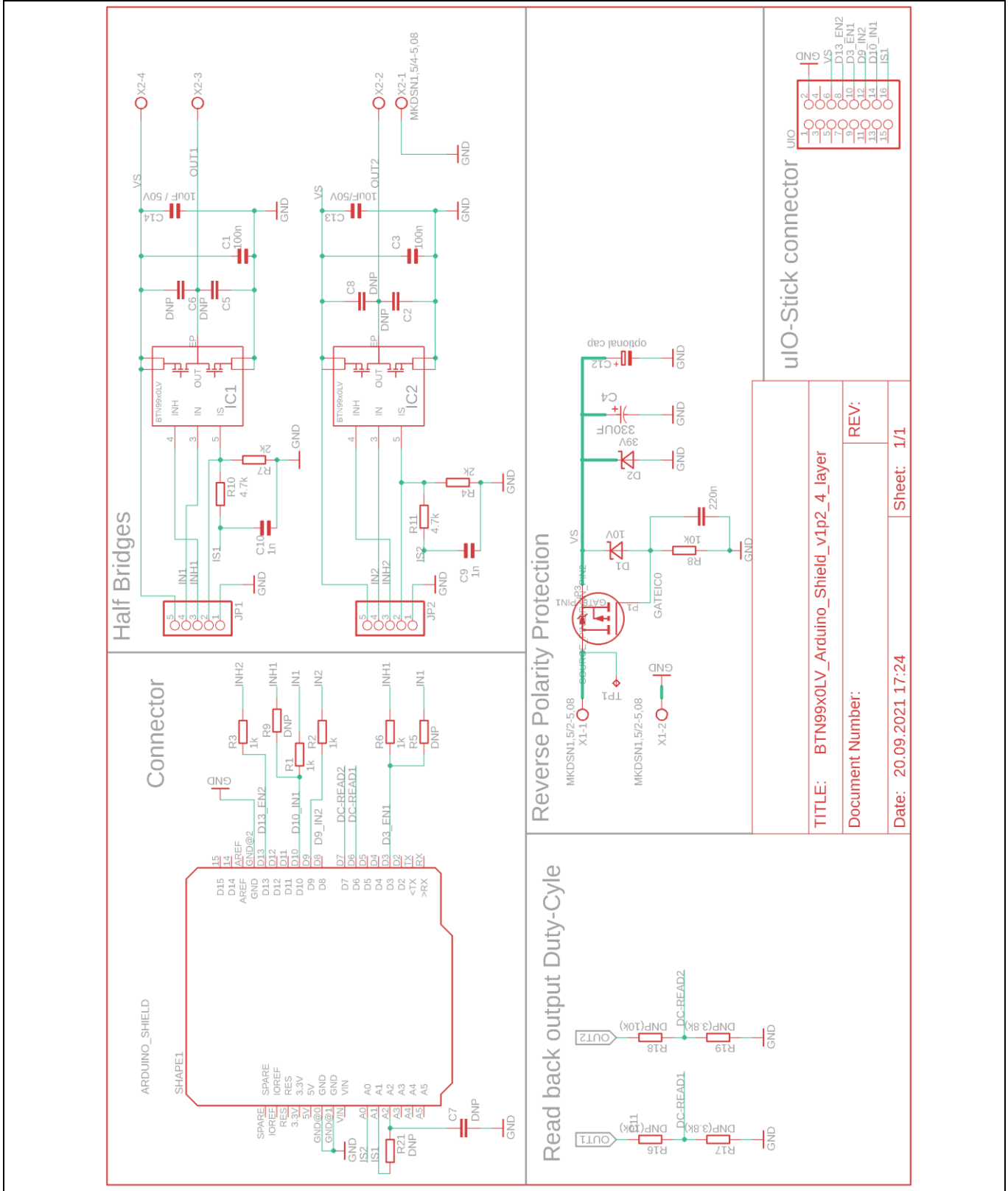

Figure 8 Schematics DC-Shield_BTN9970LV (includes BTN9970LV and BTN9990LV)

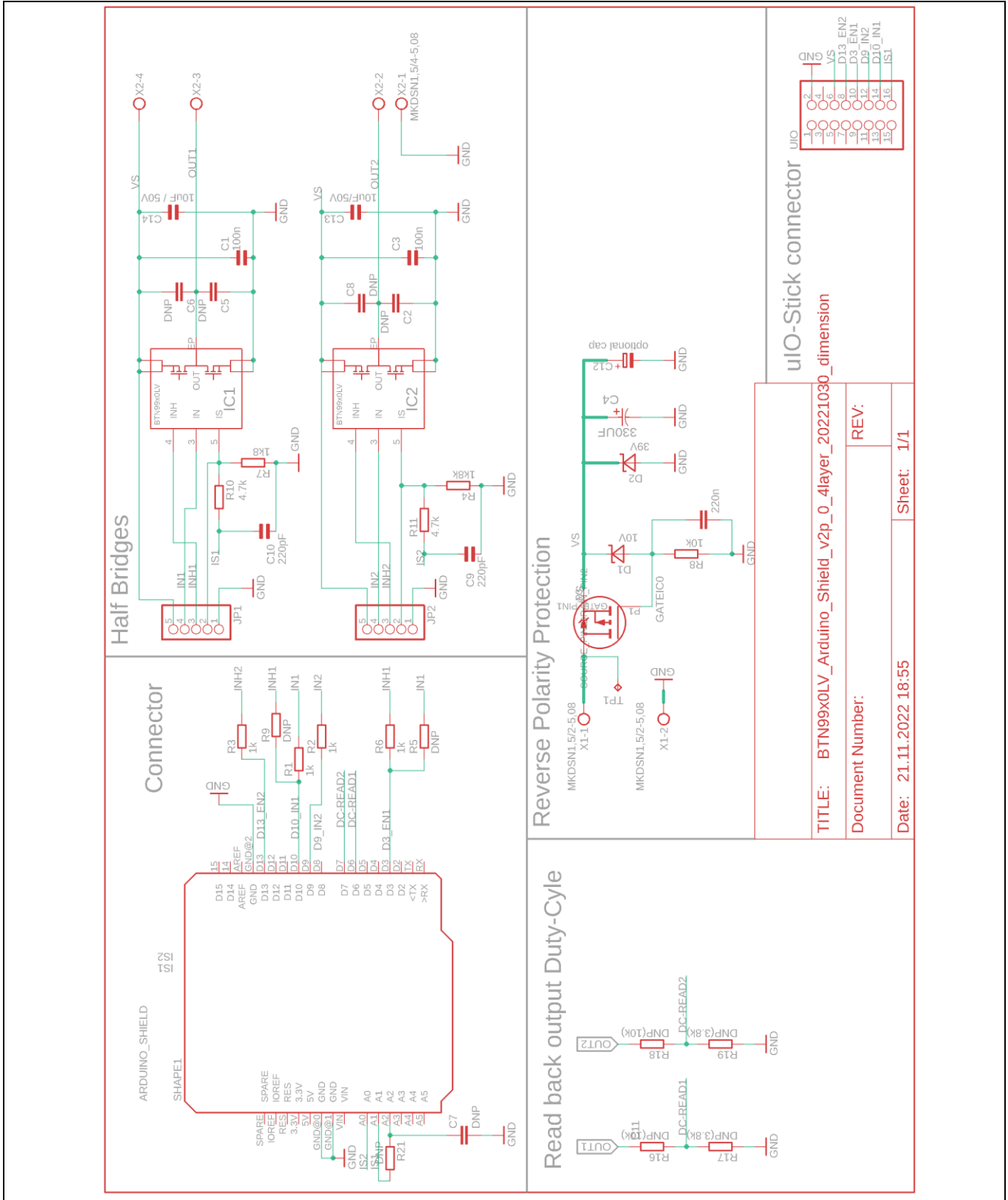

Figure 9 Schematics DC-Shield_BTN9960LV (includes 2 x BTN9960LV)

BTN9960/BTN9970/BTN9990 motor control shield

Arduino shield for evaluation

Board design

4.2 Layout

The boards are 4-layer design.

Material: FR4

Dimensions: 53 mm x 70 mm, 1.6 mm thickness

Layer stack: 4 layers 70/35/35/70 μm

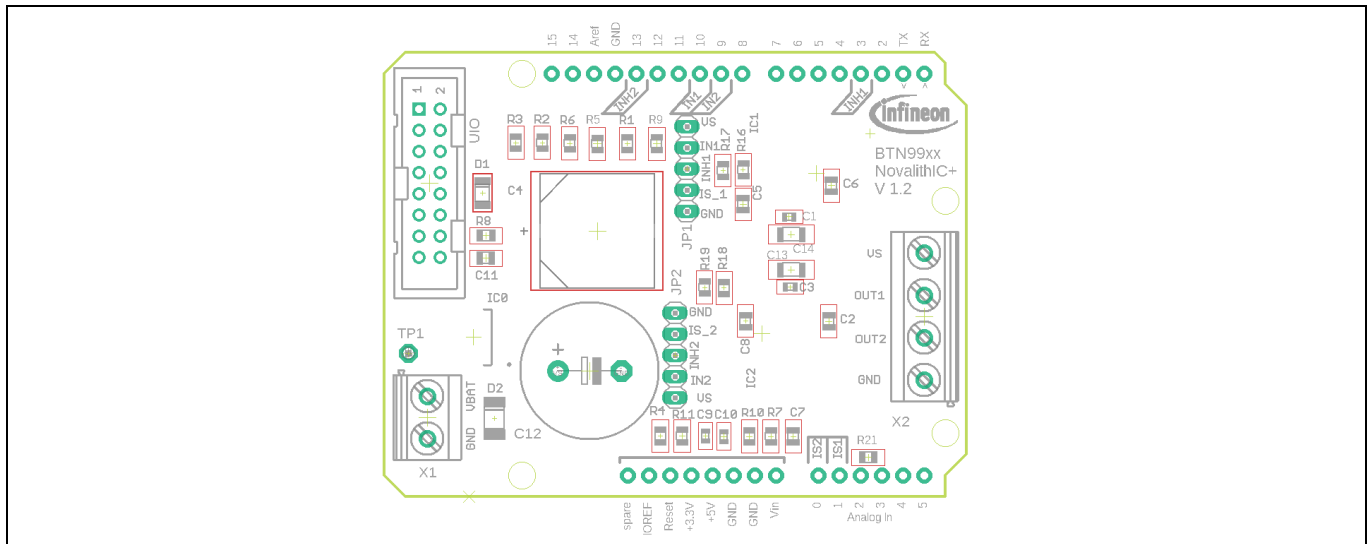

Figure 10 Components top side rev. 1.2

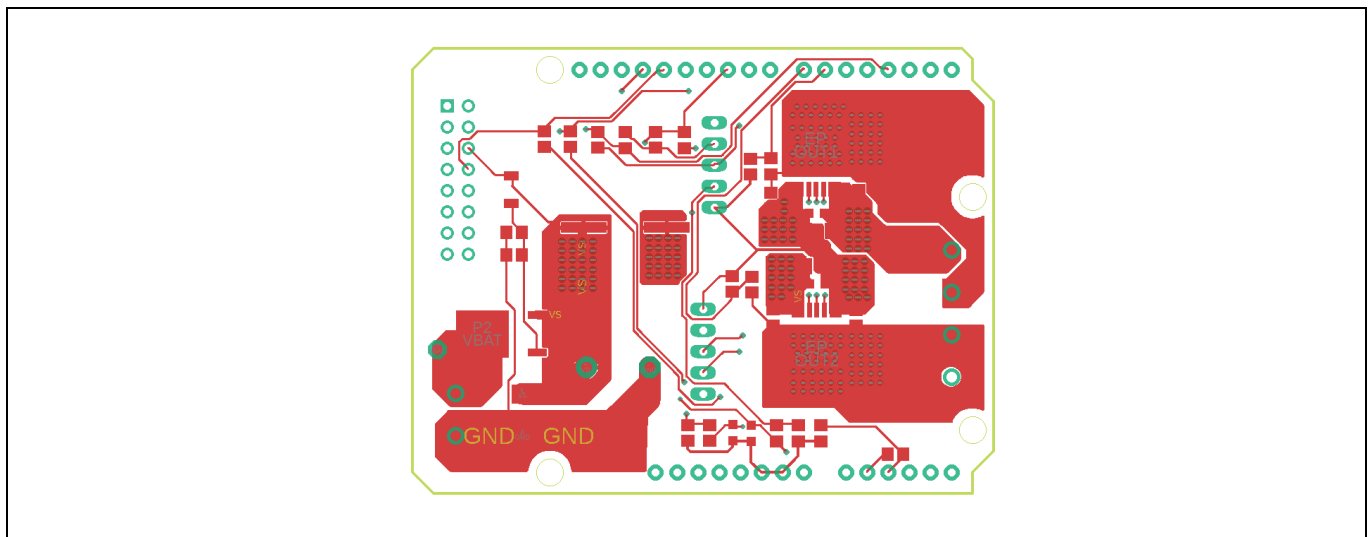

Figure 11 Top layer, top view rev. 1.2

Board design

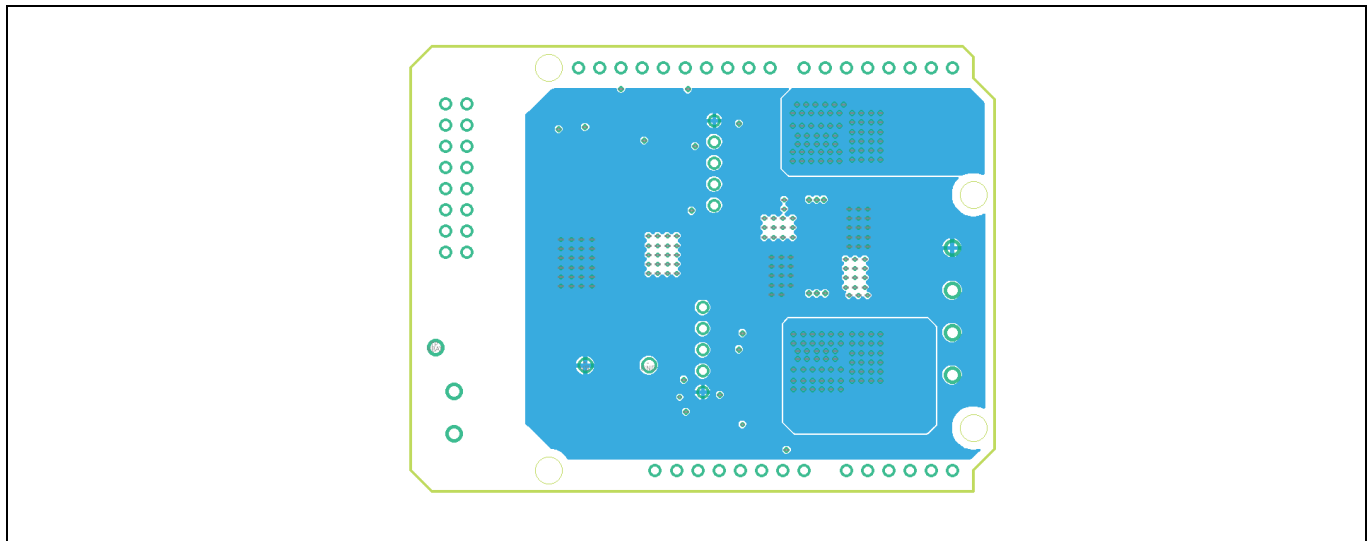

Figure 12 Inner1 layer, top view rev. 1.2

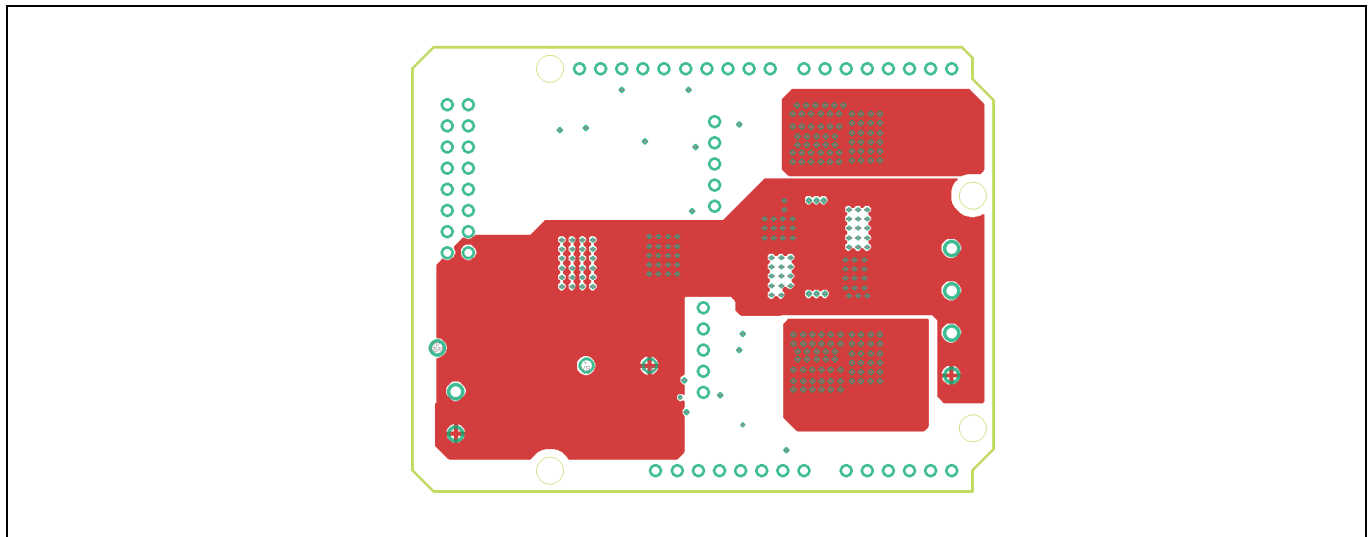

Figure 13 Inner2 layer, top view rev. 1.2

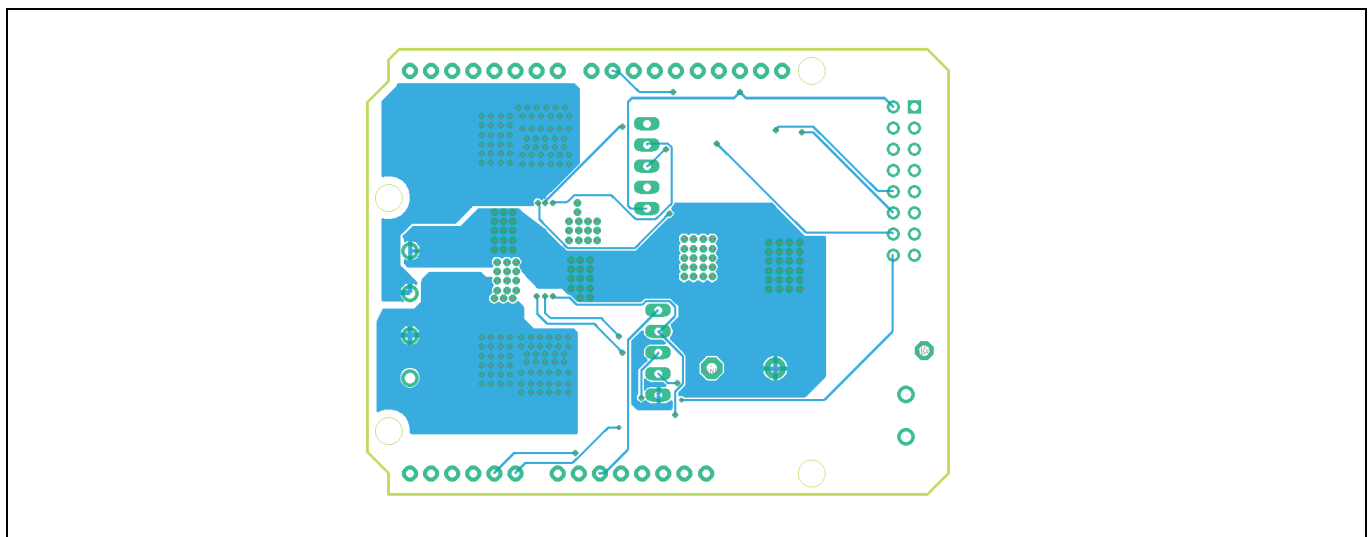

Figure 14 Bottom layer, bottom view rev. 1.2

Board design

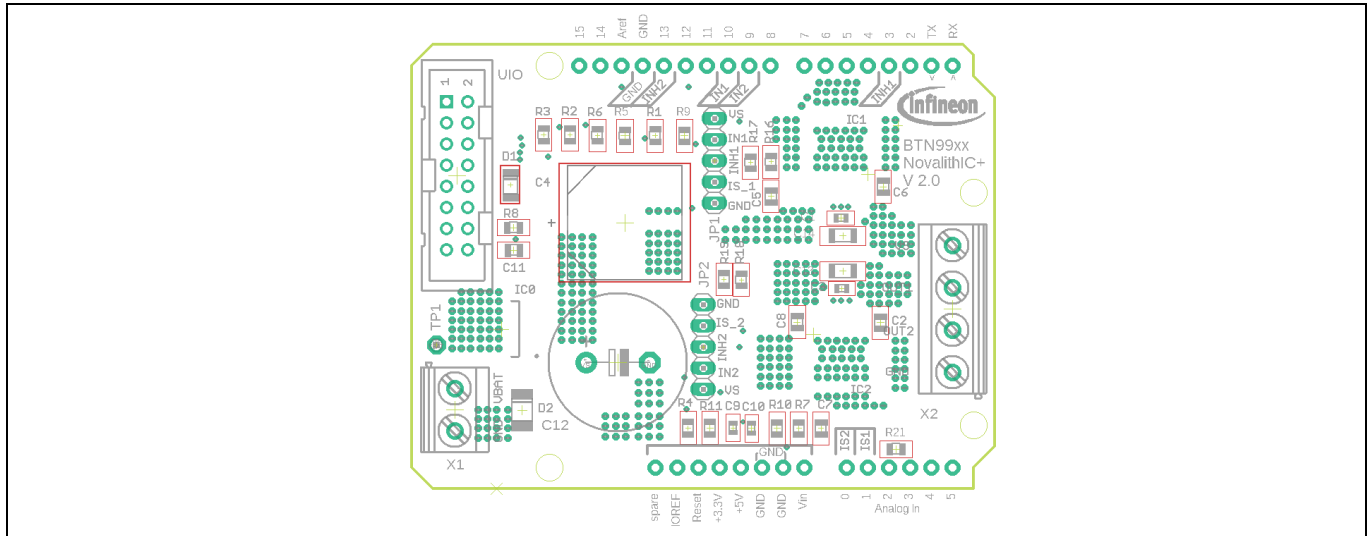

Figure 15 Components top side rev. 2.0

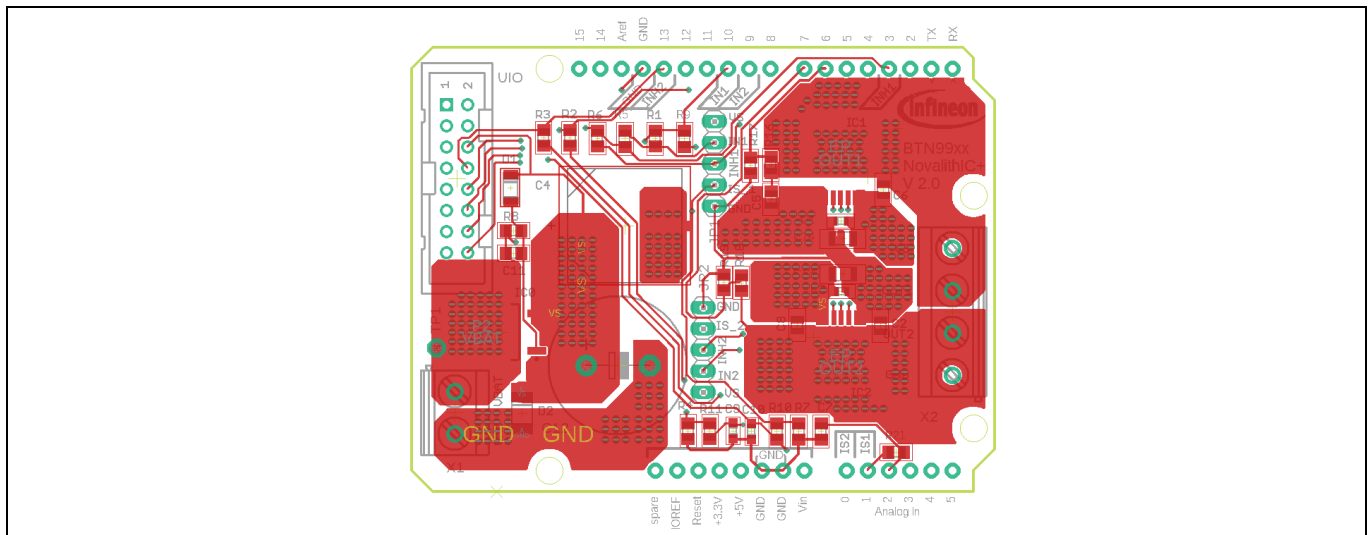

Figure 16 Top layer, top view rev. 2.0

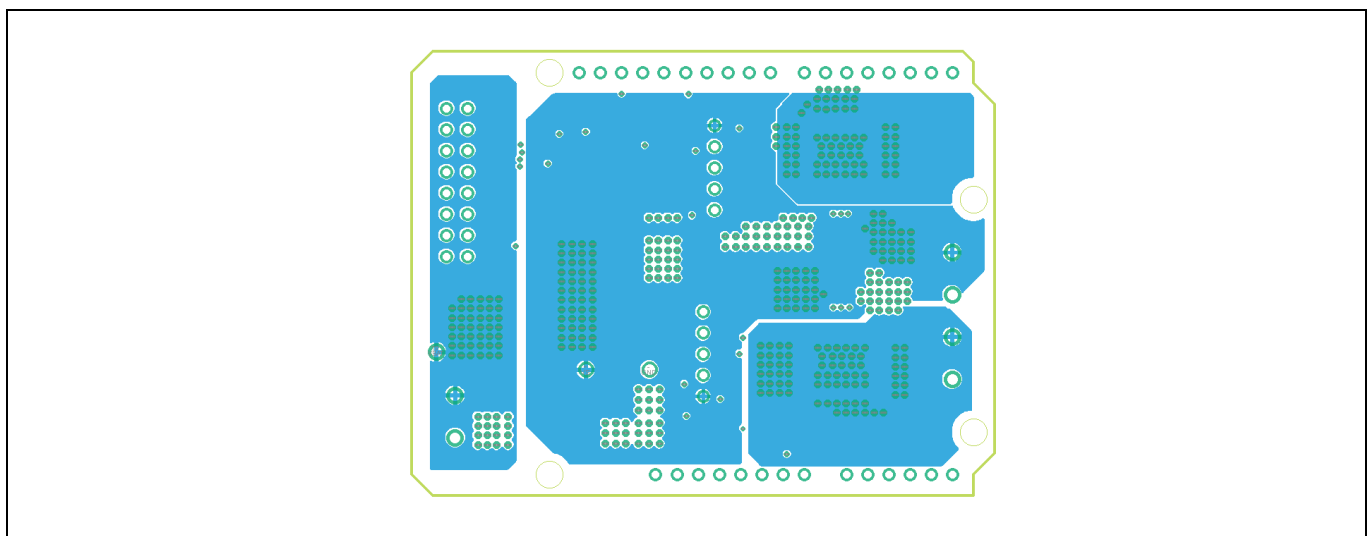

Figure 17 Inner1 layer, top view rev. 2.0

Board design

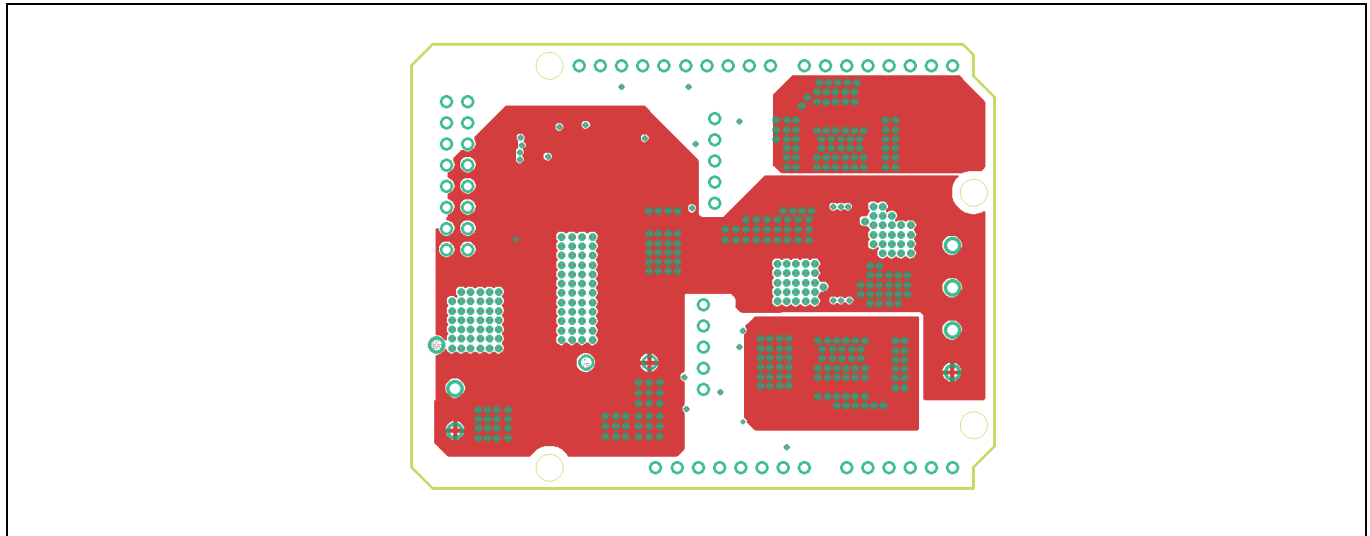

Figure 18 Inner2 layer, top view rev. 2.0

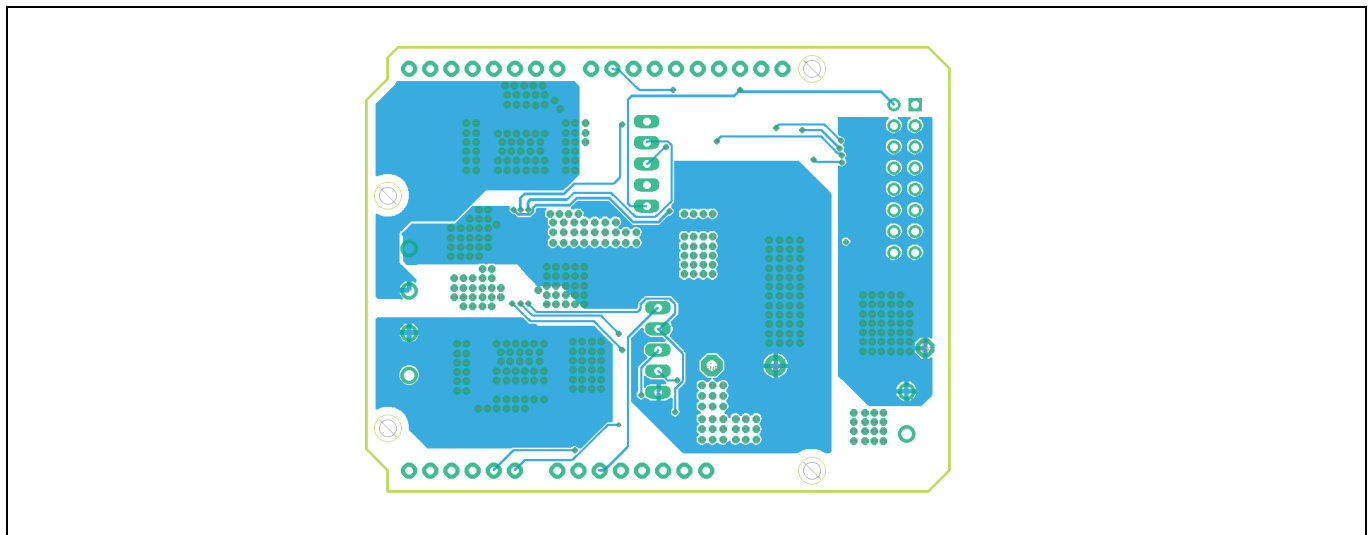

Figure 19 Bottom layer, bottom view rev. 2.0

4.3 Bill of material

Table 2 BOM of the most important parts of the board DC-Shield_BTN9970LV

Part	Value	Mounted	Package	Description	Part number	Supplier
C1	100 nF	yes	603	AEC Q200, Ceramic capacitor	GCJ188R71H104 KA12D	Murata
C2	DNP	no	C0805	AEC Q200, Ceramic capacitor		Murata, TDK
C3	100 nF	yes	603	AEC Q200, Ceramic capacitor	GCJ188R71H104 KA12D	Murata
C4	330 μ F or 390 μ F	yes	CAPAE1350X1400N	AECQ200, Aluminum Electrolytic Capacitor, SMD	EEV-TG1H331Q EEE-FK1H331AQ EEE-FK1H391AV UCD1H331MNQ1 MS 50SEV330M12	Panasonic/ Rubycon/ Nichicon
C5	DNP	no	C0805	AEC Q200, Ceramic capacitor		Murata, TDK
C6	DNP	no	C0805	AEC Q200, Ceramic capacitor		Murata, TDK
C7	DNP	no	C0805	AEC Q200, Ceramic capacitor		Murata, TDK
C8	DNP	no	C0805	AEC Q200, Ceramic capacitor		Murata, TDK
C9	1 nF	yes	C0603	AEC Q200, Ceramic capacitor	GCM188R71H10 2KA37D	Murata, TDK
C10	1 nF	yes	C0603	AEC Q200, Ceramic capacitor	GCM188R71H10 2KA37D	Murata, TDK
C11	220 nF	yes	C0805	AEC Q200, Ceramic capacitor	GCM21BR71H22 4KA37K	Murata, TDK
C12	1000 μ F	no	E7,5-16	POLARIZED ELECTROLYTIC/ TANTALUM, AECQ200	B41888D6108M	TDK
C13	10 μ F/50 V	yes	C-1206	AEC Q200, Ceramic capacitor	GRT31CR61H106 ME01L	Murata

BTN9960/BTN9970/BTN9990 motor control shield

Arduino shield for evaluation



Board design

Part	Value	Mounted	Package	Description	Part number	Supplier
C14	10 μ F/50 V	yes	C-1206	AEC Q200, Ceramic capacitor	GRT31CR61H106 ME01L	Murata
D1	10 V	yes	SMD-SOD80		BZV55-B10	NXP
D2	39 V	yes	SMD-MELF-D		ZMY39-GS08	Vishay
IC0	IPD90P04P4 L-04	yes	TO-252-3-313-L	IPD90P04P4L-04 Alternative: IPD85P04P4L06A TMA2		Infineon
IC1	BTN9990LV	yes	HSOF-7	High current PN half-bridge with integrated driver		Infineon
IC2	BTN9970LV	yes	HSOF-7	High current PN half-bridge with integrated driver		Infineon
JP1	1x5pin	yes	1x5 pin header 2,54 mm pitch	single row pin strip header	5-146277-5	TE Connectivity
JP2	1x5pin	yes	1x5 pin header 2,54 mm pitch	single row pin strip header	5-146277-5	TE Connectivity
R1	1 k Ω	yes	R0805	AEC Q200, resistor		
R2	1 k Ω	yes	R0805	AEC Q200, resistor		
R3	1 k Ω	yes	R0805	AEC Q200, resistor		
R4	2 k Ω	yes	R0805	AEC Q200, resistor		
R5	DNP	no				
R6	1 k Ω	yes	R0805	AEC Q200, resistor		
R7	2 k Ω	yes	R0805	AEC Q200, resistor		
R8	10 k Ω	yes	R0805	AEC Q200, resistor		
R9	DNP	no				
R10	4.7 k Ω	yes	R0805	AEC Q200, resistor		
R11	4.7 k Ω	yes	R0805	AEC Q200, resistor		
R16	DNP(10 k Ω)	no	R0805	AEC Q200, resistor		
R17	DNP(3.8 k Ω)	no	R0805	AEC Q200, resistor		
R18	DNP(10 k Ω)	no	R0805	AEC Q200, resistor		
R19	DNP(3.8 k Ω)	no	R0805	AEC Q200, resistor		

Board design

Part	Value	Mounted	Package	Description	Part number	Supplier
R21	DNP	no	R0805	AEC Q200, resistor		
TP1	TPPAD1-13	no	P1-13	Test pad		
UIO	2x8 pin	yes	2,54 mm pitch	Dual row header without isolation	826656-8	TE
X1	2 terminal screw connector	yes	5,08 mm pitch	MKDSN series, AWG 12-30	1888687	Phonix Contact
X2	4 terminal screw connector	yes	5,08 mm pitch	MKDSN series, AWG 12-30	1888700	Phonix Contact

Table 3 BOM of the most important parts of the board DC-Shield_BTN9960LV

Part	Value	Mounted	Package	Description	Part number	Supplier
C1	100 nF	yes	603	AEC Q200, Ceramic capacitor	GCJ188R71H104 KA12D	Murata
C2	DNP	no	C0805	AEC Q200, Ceramic capacitor		Murata, TDK
C3	100 nF	yes	603	AEC Q200, Ceramic capacitor	GCJ188R71H104 KA12D	Murata
C4	330 µF or 390 µF	yes	CAPAE1350X1400N	AECQ200, Aluminum Electrolytic Capacitor, SMD	EEV-TG1H331Q EEE-FK1H331AQ EEE-FK1H391AV UCD1H331MNQ1 MS 50SEV330M12	Panasonic/ Rubycon/ Nichicon
C5	DNP	no	C0805	AEC Q200, Ceramic capacitor		Murata, TDK
C6	DNP	no	C0805	AEC Q200, Ceramic capacitor		Murata, TDK
C7	DNP	no	C0805	AEC Q200, Ceramic capacitor		Murata, TDK
C8	DNP	no	C0805	AEC Q200, Ceramic capacitor		Murata, TDK
C9	220 pF	yes	C0603	AEC Q200, Ceramic capacitor		Murata, TDK
C10	220 pF	yes	C0603	AEC Q200, Ceramic capacitor		Murata, TDK

Board design

Part	Value	Mounted	Package	Description	Part number	Supplier
C11	220 nF	yes	C0805	AEC Q200, Ceramic capacitor	GCM21BR71H224KA37K	Murata, TDK
C12	1000 µF	no	E7,5-16	POLARIZED ELECTROLYTIC/ TANTALUM, AECQ200	B41888D6108M	TDK
C13	10 µF/50 V	yes	C-1206	AEC Q200, Ceramic capacitor	GRT31CR61H106ME01L	Murata
C14	10 µF/50 V	yes	C-1206	AEC Q200, Ceramic capacitor	GRT31CR61H106ME01L	Murata
D1	10 V	yes	SMD-SOD80		BZV55-B10	NXP
D2	39 V	yes	SMD-MELF-D		ZMY39-GS08	Vishay
IC0	IPD90P04P4L-04	yes	TO-252-3-313-L	IPD90P04P4L-04 Alternative: IPD85P04P4L06A TMA2		Infineon
IC1	BTN9990LV	yes	HSOF-7	High current PN half-bridge with integrated driver		Infineon
IC2	BTN9970LV	yes	HSOF-7	High current PN half-bridge with integrated driver		Infineon
JP1	1x5pin	yes	1x5 pin header 2,54 mm pitch	single row pin strip header	5-146277-5	TE Connectivity
JP2	1x5pin	yes	1x5 pin header 2,54 mm pitch	single row pin strip header	5-146277-5	TE Connectivity
R1	1 kΩ	yes	R0805	AEC Q200, resistor		
R2	1 kΩ	yes	R0805	AEC Q200, resistor		
R3	1 kΩ	yes	R0805	AEC Q200, resistor		
R4	1.8 kΩ	yes	R0805	AEC Q200, resistor 0,1%		
R5	DNP	no				
R6	1 kΩ	yes	R0805	AEC Q200, resistor		
R7	1.8 kΩ	yes	R0805	AEC Q200, resistor, 0,1%		
R8	10 kΩ	yes	R0805	AEC Q200, resistor		
R9	DNP	no				
R10	4.7 kΩ	yes	R0805	AEC Q200, resistor		

Board design

Part	Value	Mounted	Package	Description	Part number	Supplier
R11	4.7 kΩ	yes	R0805	AEC Q200, resistor		
R16	DNP(10 kΩ)	no	R0805	AEC Q200, resistor		
R17	DNP(3.8 kΩ)	no	R0805	AEC Q200, resistor		
R18	DNP(10 kΩ)	no	R0805	AEC Q200, resistor		
R19	DNP(3.8 kΩ)	no	R0805	AEC Q200, resistor		
R21	DNP	no	R0805	AEC Q200, resistor		
UIO	2x8 pin	yes	2,54 mm pitch	Dual row header without isolation	826656-8	TE
X1	2 terminal screw connector	yes	5,08 mm pitch	MKDSN series, AWG 12-30	1888687	Phonix Contact
X2	4 terminal screw connector	yes	5,08 mm pitch	MKDSN series, AWG 12-30	1888700	Phonix Contact

5 References and appendices

5.1 Abbreviations and definitions

Table 4 Abbreviations

Abbreviation	Meaning
CE	Conformité Européenne
EMI	Electromagnetic interference
UL	Underwriters Laboratories

5.2 References

- [1] Infineon Technologies AG, Datasheet: BTN9970LV
- [2] Infineon Technologies AG, Datasheet: BTN9990LV
- [3] Infineon Technologies AG, Datasheet: BTN9960LV
- [4] Arduino UNO web page [Online] store.arduino.cc/arduino-uno-rev3
- [5] Arduino home page [Online] www.arduino.cc
- [6] Web folder of Infineon's [Single Half-Bridge ICs](#)

6 Revision history

Table 5 Revision history

Revision number	Date of release	Description of changes
Rev. 2.0	2023-04-15	Added DC-Shield_BTN9960LV board Rev 2.0
Rev. 1.10	2021-09-30	Board changed to Ver 1.2 with 4 layers PCB, optimized board layout, larger screw headers and test pins to analyze I/O signals of half-bridges
Rev. 1.00	2021-02-09	Initial document created, based on board 1.1

Trademarks

All referenced product or service names and trademarks are the property of their respective owners.

Edition 2023-04-18

Published by

Infineon Technologies AG

81726 Munich, Germany

© 2023 Infineon Technologies AG.

All Rights Reserved.

Do you have a question about this document?

Email: erratum@infineon.com

Document reference

Z8F80043943

For further information on the product, technology, delivery terms and conditions and prices please contact your nearest Infineon Technologies office (www.infineon.com).

WARNINGS

Due to technical requirements products may contain dangerous substances. For information on the types in question please contact your nearest Infineon Technologies office.

Except as otherwise explicitly approved by Infineon Technologies in a written document signed by authorized representatives of Infineon Technologies, Infineon Technologies' products may not be used in any applications where a failure of the product or any consequences of the use thereof can reasonably be expected to result in personal injury.

X-ON Electronics

Largest Supplier of Electrical and Electronic Components

Click to view similar products for [Power Management IC Development Tools](#) category:

Click to view products by [Infineon](#) manufacturer:

Other Similar products are found below :

[EVB-EP5348UI](#) [BQ25010EVM](#) [ISL80019AEVAL1Z](#) [ISLUSBI2CKIT1Z](#) [ISL8002AEVAL1Z](#) [ISL91108IIA-EVZ](#) [MAX8556EVKIT](#)
[MAX15005AEVKIT+](#) [ISL28022EVKIT1Z](#) [STEVAL-ISA008V1](#) [DRI0043](#) [KITPF8100FRDMEVM](#) [EVB-EN6337QA](#)
[SAMPLEBOXILD8150TOBO1](#) [MAX18066EVKIT#](#) [AP62300WU-EVM](#) [KITA2GTC387MOTORCTRTOBO1](#) [AEK-MOT-TK200G1](#)
[EVLONE65W](#) [STEVAL-ILH006V1](#) [STEVAL-IPE008V2](#) [STEVAL-IPP001V2](#) [STEVAL-ISA013V1](#) [STEVAL-ISA067V1](#) [STEVAL-](#)
[ISQ002V1](#) [TPS2306EVM-001](#) [TPS2330EVM-185](#) [TPS40001EVM-001](#) [SECO-HVDCDC1362-15W-GEVB](#) [BTS7030-2EPA](#)
[LT8638SJV#WPBF](#) [LTC3308AIV#WTRPBF](#) [TLT807B0EPV](#) [BTS71033-6ESA](#) [EV13N91A](#) [EASYPIC V8 OVER USB-C](#) [EV55W64A](#)
[CLICKER 4 FOR STM32F4](#) [EASYMX PRO V7A FOR STM32](#) [CLICKER 4 FOR PIC18F](#) [Si8285_86v2-KIT](#) [PAC52700EVK1](#) [NCP-](#)
[NCV51752D2PAK3LGEVB](#) [ISL81807EVAL1Z](#) [AP33772S-EVB](#) [EVALM7HVIGBTFCINV4TOBO1](#) [903-0300-000](#) [902-0173-000](#) [903-](#)
[0301-000](#) [ROA1286023/1](#)