

# Protection Device

TVS (Transient Voltage Suppressor)

## ESD114-U1-02 Series

Uni-directional, 5.3 V, 0.4 pF, 0402, 0201, RoHS and Halogen Free compliant

ESD114-U1-02ELS  
ESD114-U1-02EL

## Data Sheet

Revision 1.0, 2014-10-30  
Final

**Edition 2014-10-30**

**Published by**

**Infineon Technologies AG**

**81726 Munich, Germany**

**© 2014 Infineon Technologies AG**

**All Rights Reserved.**

### **Legal Disclaimer**

The information given in this document shall in no event be regarded as a guarantee of conditions or characteristics. With respect to any examples or hints given herein, any typical values stated herein and/or any information regarding the application of the device, Infineon Technologies hereby disclaims any and all warranties and liabilities of any kind, including without limitation, warranties of non-infringement of intellectual property rights of any third party.

### **Information**

For further information on technology, delivery terms and conditions and prices, please contact the nearest Infineon Technologies Office ([www.infineon.com](http://www.infineon.com))

### **Warnings**

Due to technical requirements, components may contain dangerous substances. For information on the types in question, please contact the nearest Infineon Technologies Office.

Infineon Technologies components may be used in life-support devices or systems only with the express written approval of Infineon Technologies, if a failure of such components can reasonably be expected to cause the failure of that life-support device or system or to affect the safety or effectiveness of that device or system. Life support devices or systems are intended to be implanted in the human body or to support and/or maintain and sustain and/or protect human life. If they fail, it is reasonable to assume that the health of the user or other persons may be endangered.

# 1 Product Overview

## 1.1 Features

- ESD / Transient protection of high speed data lines exceeding
  - IEC61000-4-2 (ESD):  $\pm 20$  kV (contact)
  - IEC61000-4-4 (EFT):  $\pm 2$  kV /  $\pm 40$  A (5/50 ns)
  - IEC61000-4-5 (surge):  $\pm 3$  A (8/20  $\mu$ s)
- Maximum working voltage:  $V_{RWM} = \pm 5.3$  V
- Ultra low capacitance:  $C_L = 0.4$  pF (typical)
- Very low clamping voltage  $V_{CL} = +20 / -15$  V (typical) at  $I_{TLP} = 16$  A
- Low dynamic resistance  $R_{DYN} = 0.5$   $\Omega$  (typical)
- Very small form factor down to 0.62 x 0.32 x 0.31 mm<sup>3</sup>
- Pb-free (RoHS compliant) and halogen free package



## 1.2 Application Examples

- USB 2.0, Mobile HDMI Link, MDDI, MIPI, etc.
- HDMI, DisplayPort, DVI, Ethernet, Firewire, S-ATA

## 1.3 Product Description

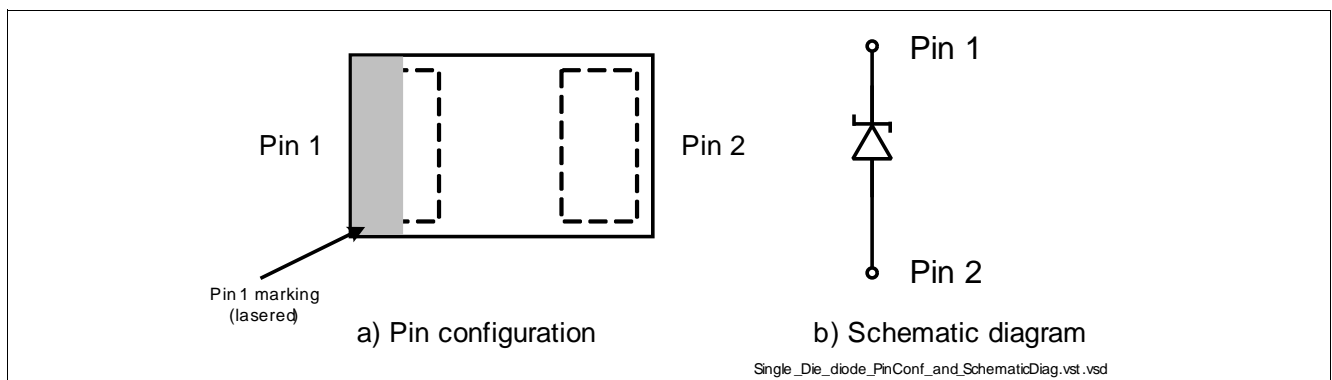

Figure 1 Pin Configuration and Schematic Diagram

Table 1 Ordering Information

Type	Package	Configuration	Marking code
ESD114-U1-02ELS	TSSLP-2-3	1 line, uni-directional	<u>K</u>
ESD114-U1-02EL	TSLP-2-19	1 line, uni-directional	K

## 2 Maximum Ratings

**Table 2** Maximum Ratings at  $T_A = 25\text{ }^\circ\text{C}$ , unless otherwise specified

Parameter	Symbol	Values	Unit
ESD contact discharge <sup>1)</sup>	$V_{ESD}$	$\pm 20$	kV
Peak pulse current ( $t_p = 8/20\ \mu\text{s}$ ) <sup>2)</sup>	$I_{PP}$	$\pm 3$	A
Operating temperature range	$T_{OP}$	-55 to 125	$^\circ\text{C}$
Storage temperature	$T_{stg}$	-65 to 150	$^\circ\text{C}$

1)  $V_{ESD}$  according to IEC61000-4-2

2) Non-repetitive current pulse 8/20 $\mu\text{s}$  exponential decay waveform according to IEC61000-4-5

**Attention:** Stresses above the max. values listed here may cause permanent damage to the device. Exposure to absolute maximum rating conditions for extended periods may affect device reliability. Maximum ratings are absolute ratings; exceeding only one of these values may cause irreversible damage to the integrated circuit.

## 3 Electrical Characteristics at $T_A = 25\text{ }^\circ\text{C}$ , unless otherwise specified

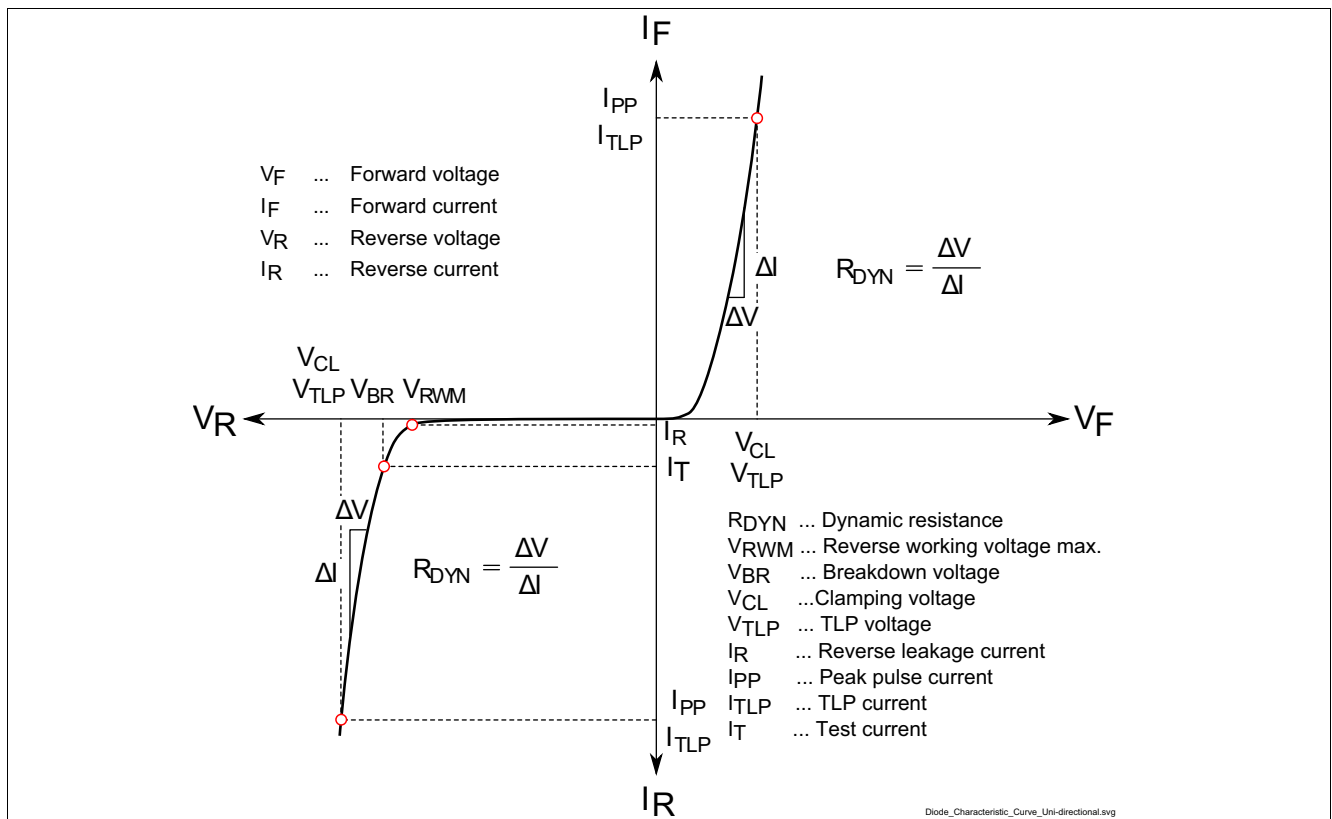

**Figure 2** Definitions of Electrical Characteristics

**Electrical Characteristics at  $T_A = 25\text{ }^\circ\text{C}$ , unless otherwise specified**
**Table 3 DC Characteristics at  $T_A = 25\text{ }^\circ\text{C}$ , unless otherwise specified**

Parameter	Symbol	Values			Unit	Note / Test Condition
		Min.	Typ.	Max.		
Reverse working voltage	$V_{RWM}$	–	–	5.3	V	Pin 1 to Pin 2
Breakdown voltage	$V_{BR}$	6	–	–	V	$I_{BR} = 1\text{ mA}$ , from Pin 1 to Pin 2
Reverse current	$I_R$	–	<10	100	nA	$V_R = 5.3\text{ V}$ , from Pin 1 to Pin 2

**Table 4 RF Characteristics at  $T_A = 25\text{ }^\circ\text{C}$ , unless otherwise specified**

Parameter	Symbol	Values			Unit	Note / Test Condition
		Min.	Typ.	Max.		
Line capacitance <sup>1)</sup>	$C_L$	–	0.4	0.6	pF	$V_R = 0\text{ V}$ , $f = 1\text{ MHz}$
Serie inductance	$L_S$	–	0.2	–	nH	ESD114-U1-02ELS
		–	0.4	–	nH	ESD114-U1-02EL

1) Total capacitance line to ground

**Table 5 ESD Characteristics at  $T_A = 25\text{ }^\circ\text{C}$ , unless otherwise specified**

Parameter	Symbol	Values			Unit	Note / Test Condition
		Min.	Typ.	Max.		
Clamping voltage	$V_{CL}$	–	10	–	V	$I_{TLP} = 1\text{ A}$ , from Pin 1 to Pin 2
		–	20	–		$I_{TLP} = 16\text{ A}$ , from Pin 1 to Pin 2
		–	28	–		$I_{TLP} = 30\text{ A}$ , from Pin 1 to Pin 2
		–	3	–		$I_{TLP} = 1\text{ A}$ , from Pin 2 to Pin 1
		–	15	–		$I_{TLP} = 16\text{ A}$ , from Pin 2 to Pin 1
		–	21	–		$I_{TLP} = 30\text{ A}$ , from Pin 2 to Pin 1
Dynamic resistance <sup>1)</sup>	$R_{DYN}$	–	0.56	–	V	Pin 1 to Pin 2
		–	0.43	–	V	Pin 2 to Pin 1

1) Please refer to Application Note AN210[1]. TLP parameter:  $Z_0 = 50\text{ }\Omega$ ,  $t_p = 100\text{ ns}$ ,  $t_r = 300\text{ ps}$ , averaging window:  $t_1 = 30\text{ ns}$  to  $t_2 = 60\text{ ns}$ , extraction of dynamic resistance using least squares fit of TLP characteristics between  $I_{PP1} = 10\text{ A}$  and  $I_{PP2} = 40\text{ A}$ .

## 4 Typical Characteristics Diagrams

Typical characteristics diagrams at  $T_A = 25^\circ\text{C}$ , unless otherwise specified

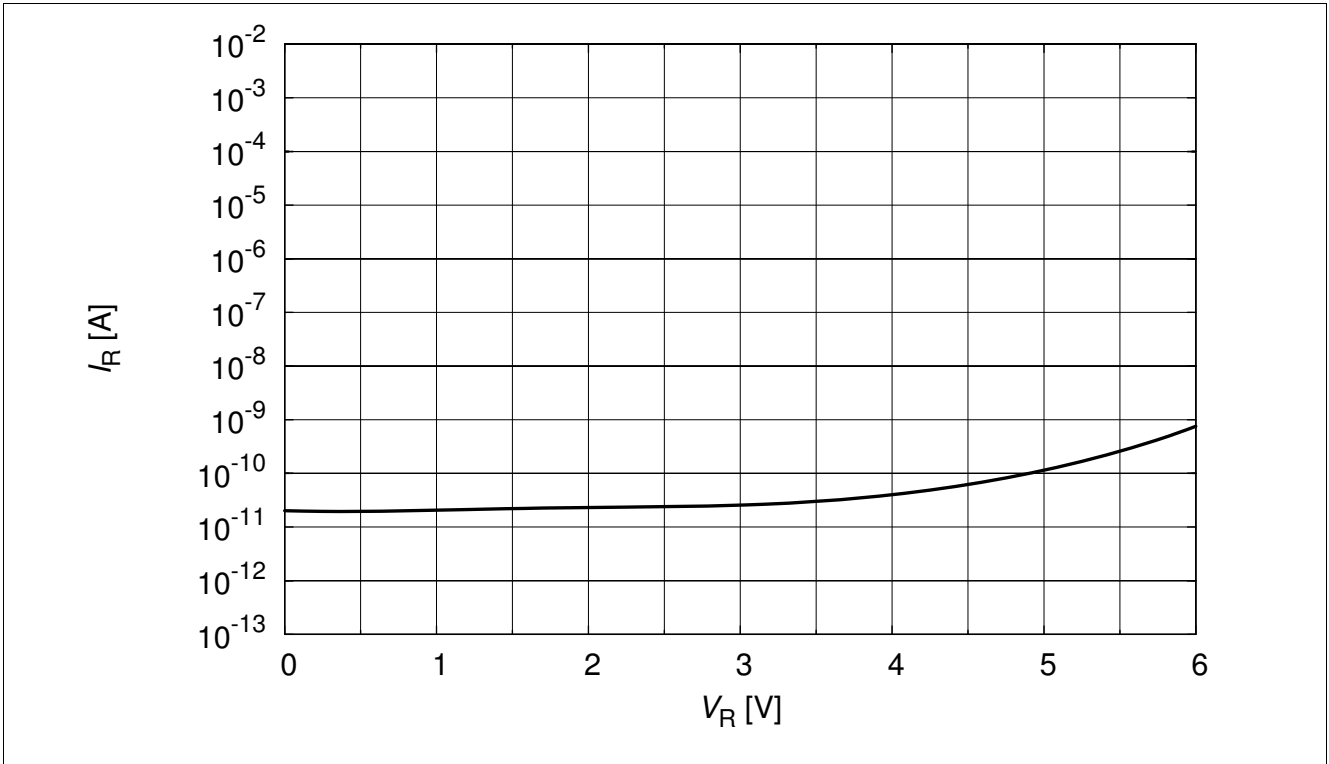

Figure 3 Reverse leakage current:  $I_R = f(V_R)$

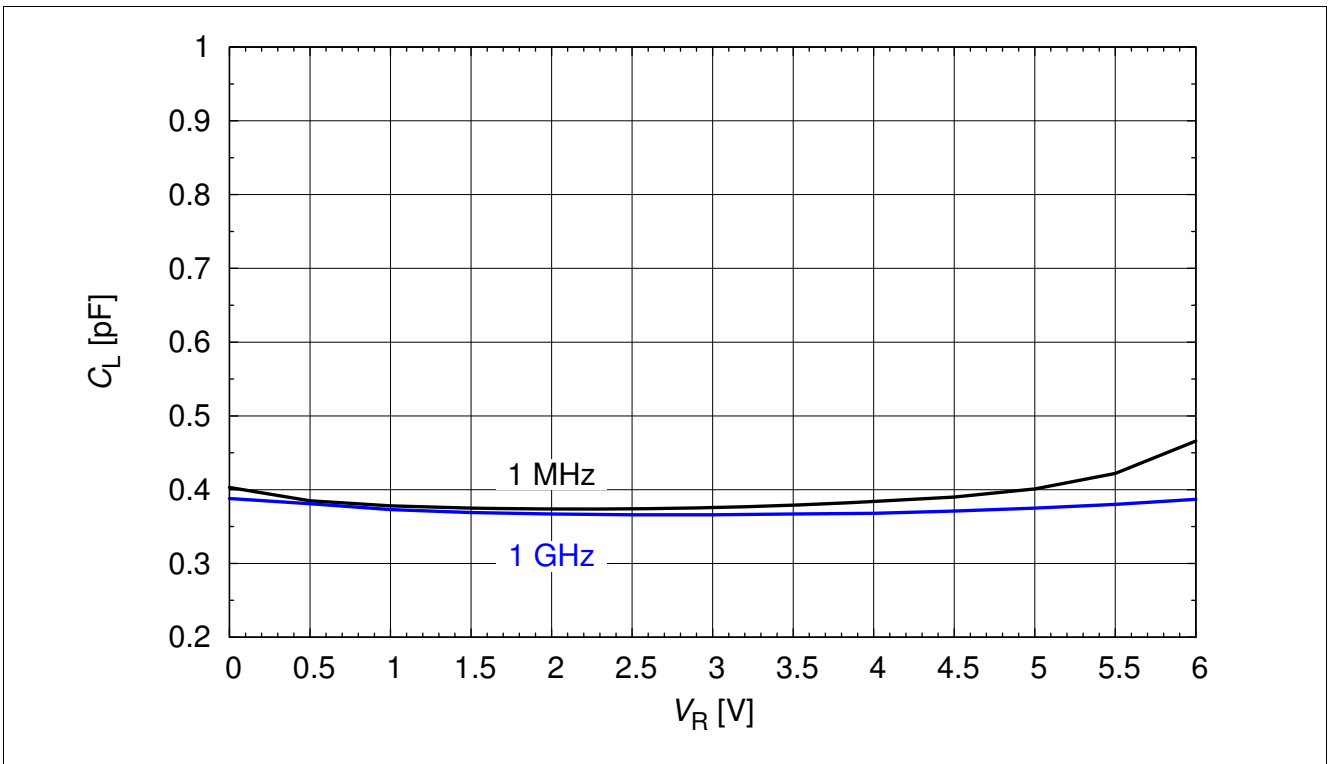

Figure 4 Line capacitance:  $C_L = f(V_R)$

Typical Characteristics Diagrams

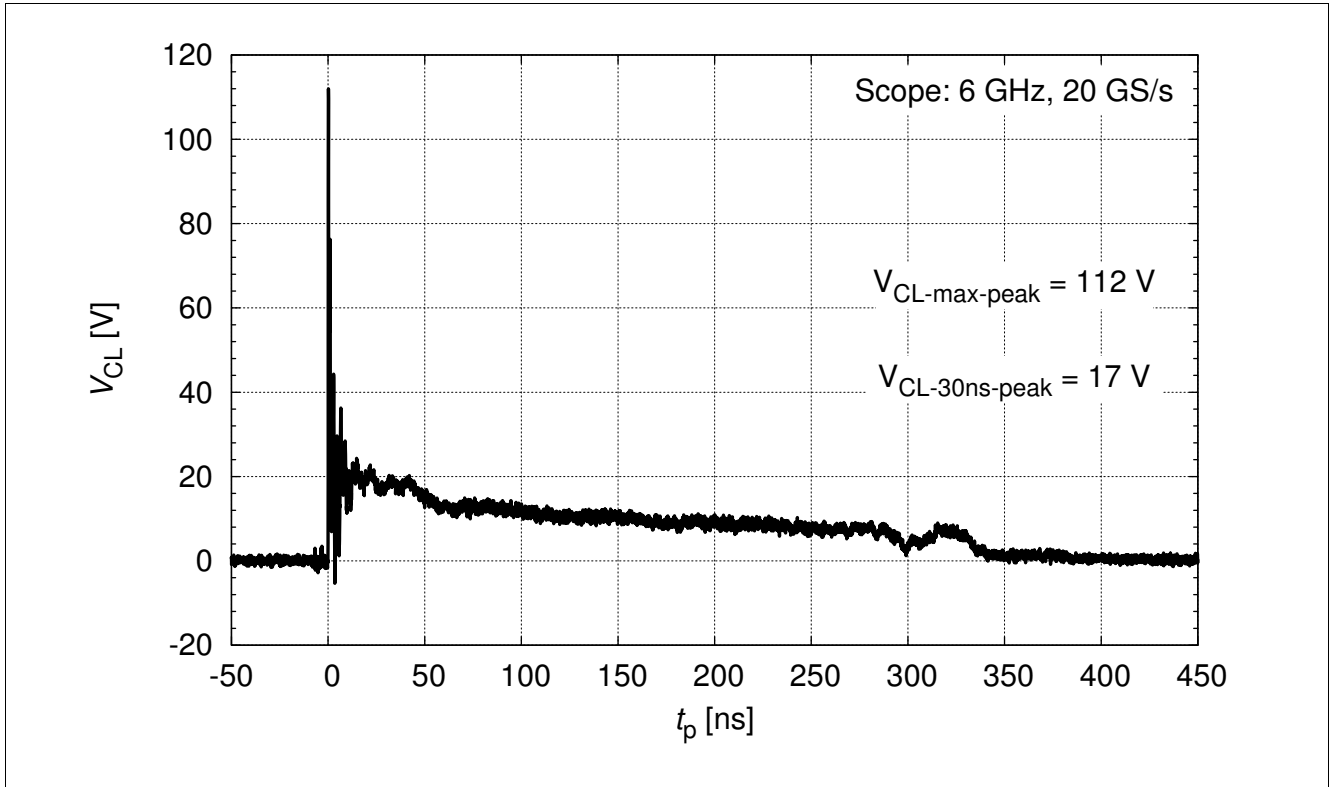

Figure 5 IEC61000-4-2 :  $V_{CL} = f(t)$ , 8 kV positive pulse from pin 1 to pin 2

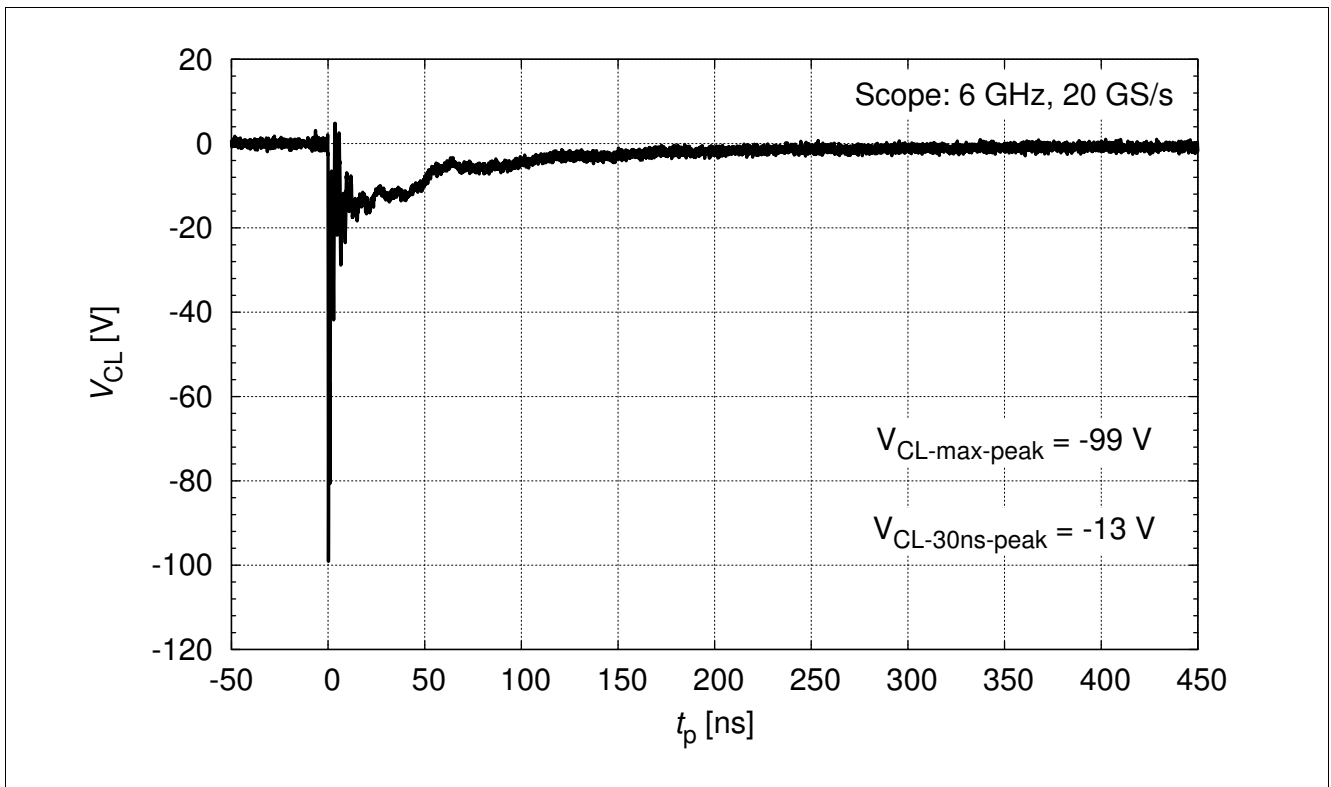

Figure 6 IEC61000-4-2 :  $V_{CL} = f(t)$ , 8 kV negative pulse from pin 1 to pin 2

Typical Characteristics Diagrams

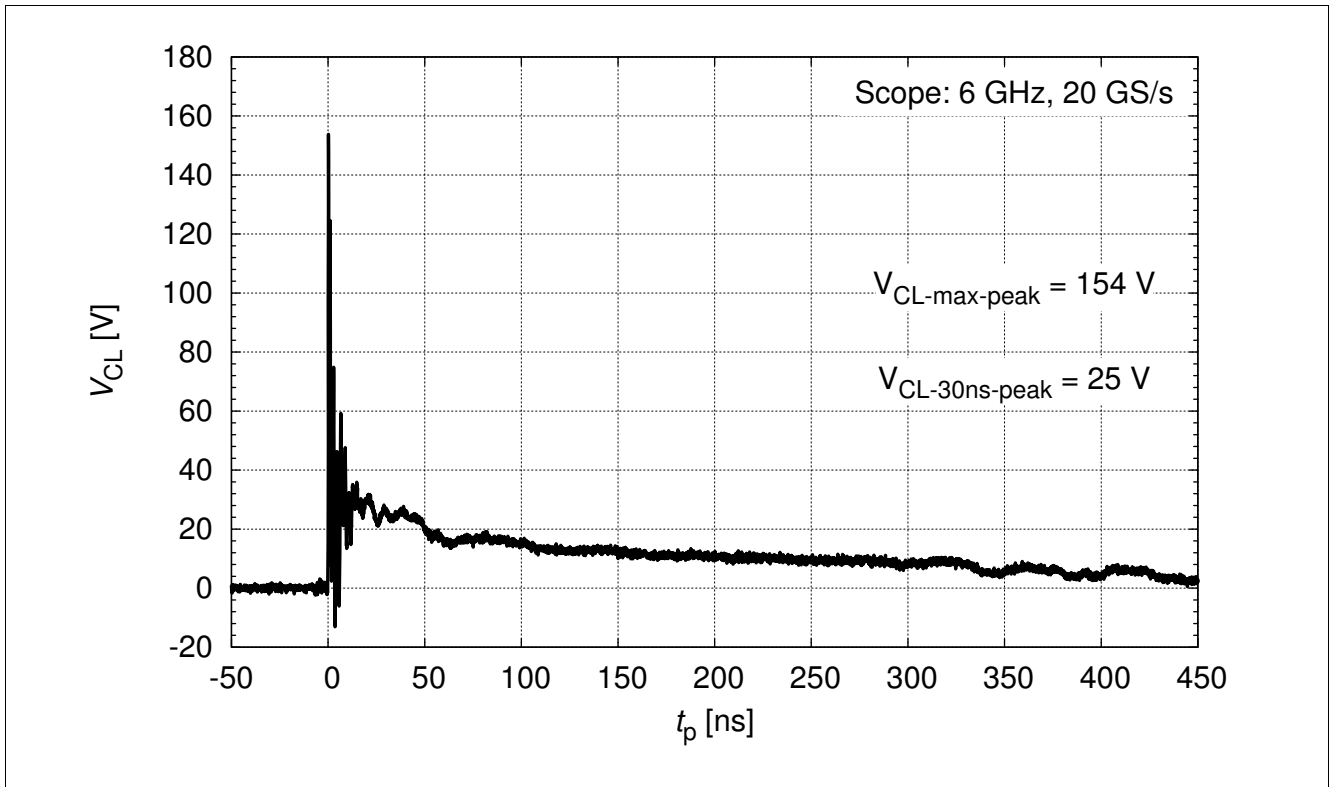

Figure 7 IEC61000-4-2 :  $V_{CL} = f(t)$ , 15 kV positive pulse from pin 1 to pin 2

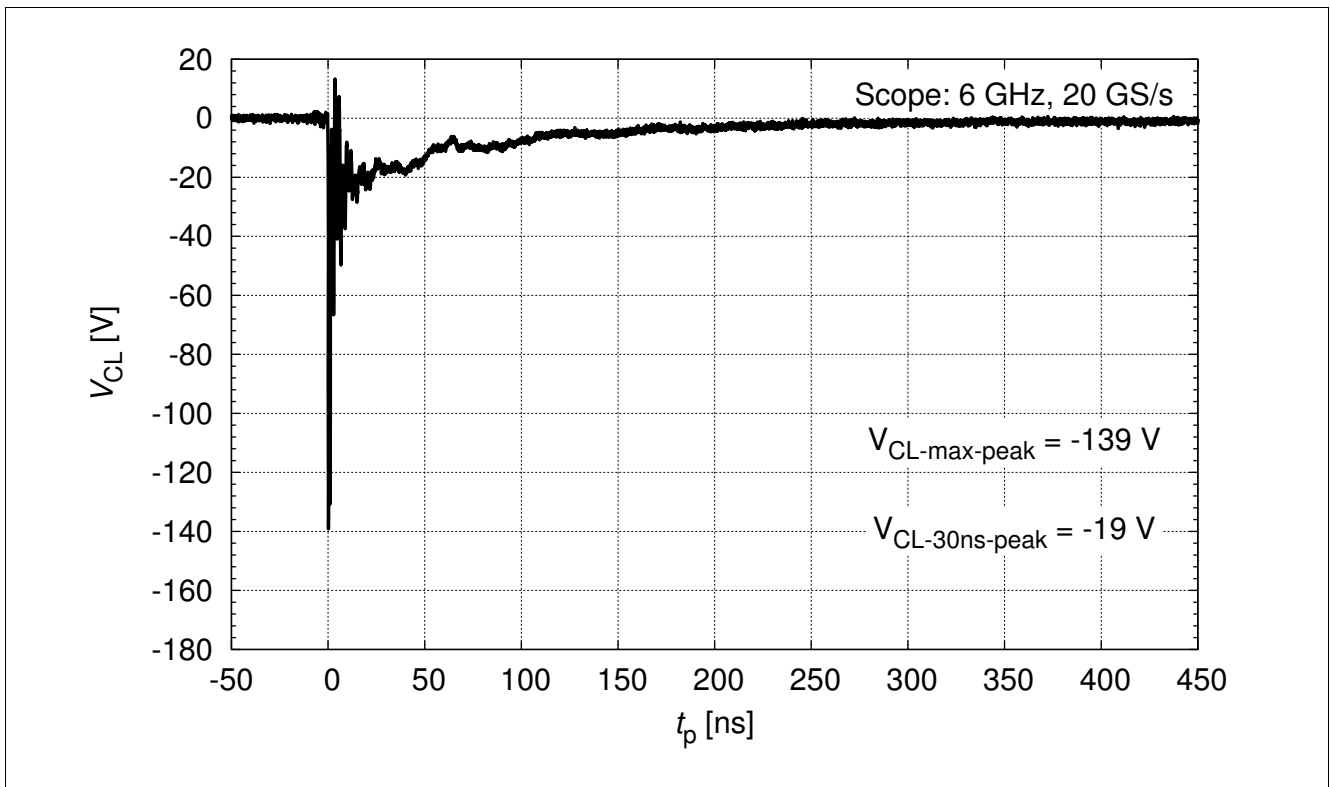

Figure 8 IEC61000-4-2 :  $V_{CL} = f(t)$ , 15 kV negative pulse from pin 1 to pin 2



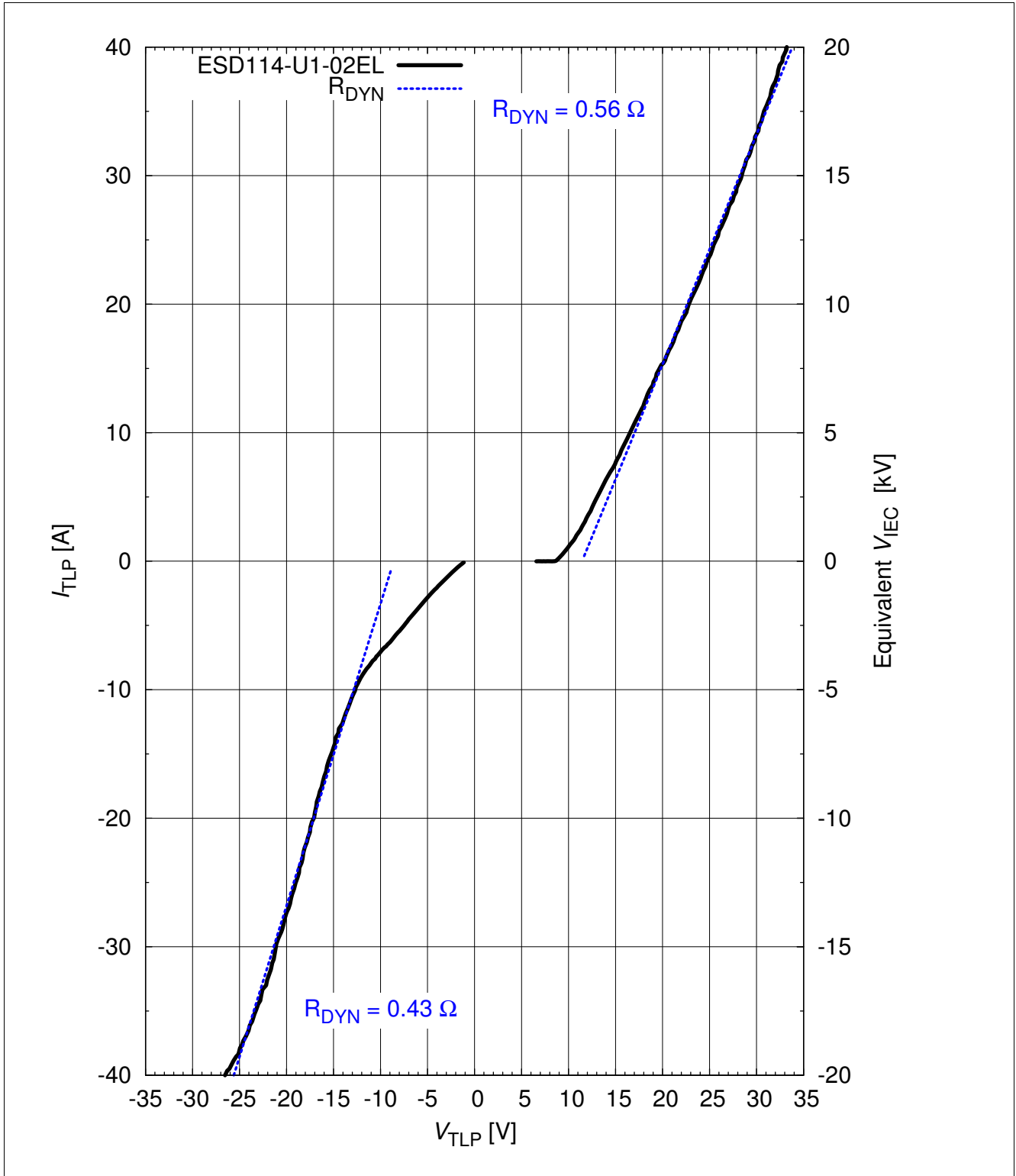

Figure 9 Clamping voltage (TLP):  $I_{TLP} = f(V_{TLP})$  [1], pin 1 to pin 2

## 5 Package Information

### 5.1 TSSLP-2-3 (mm)[3]

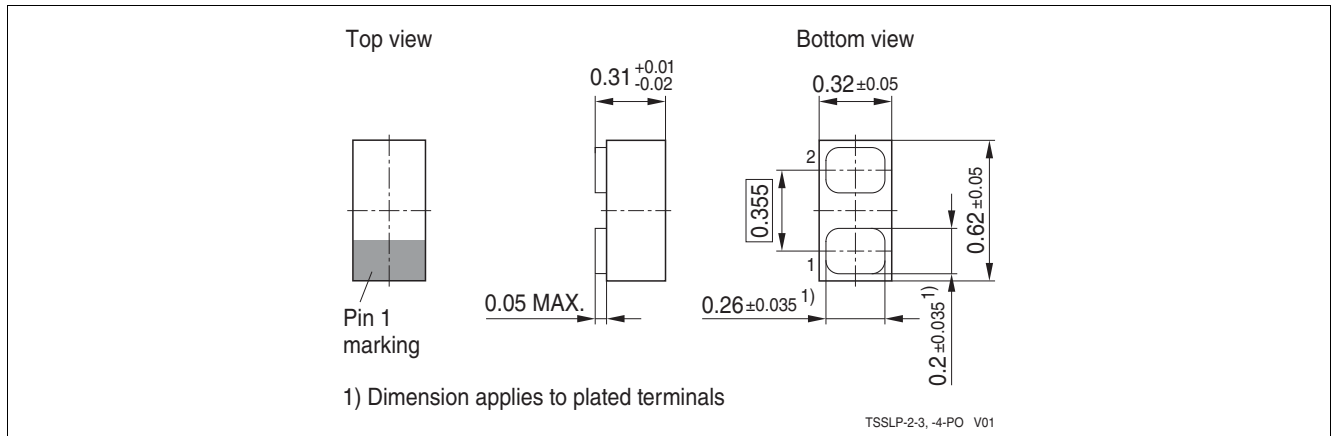

Figure 10 TSSLP-2-3: Package overview

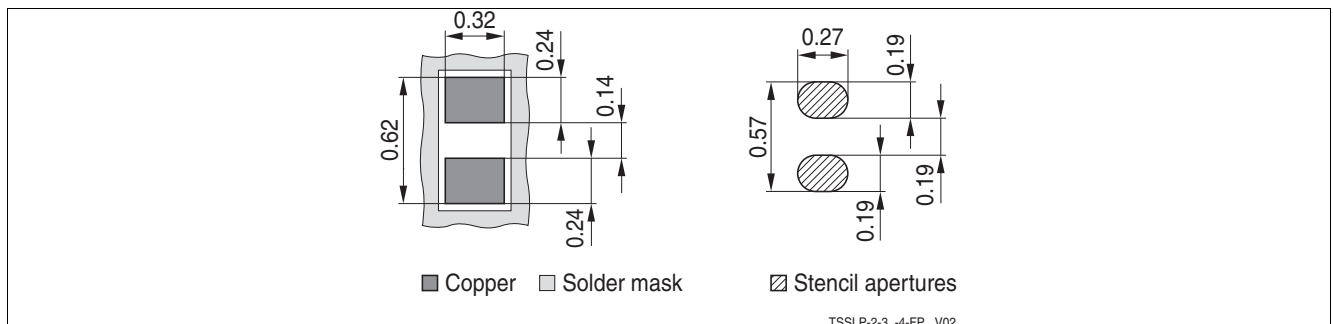

Figure 11 TSSLP-2-3 Footprint

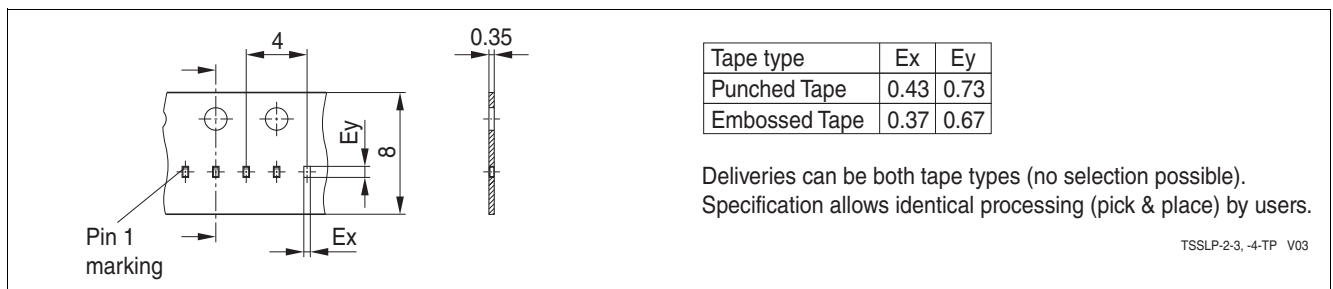

Figure 12 TSSLP-2-3: Packing

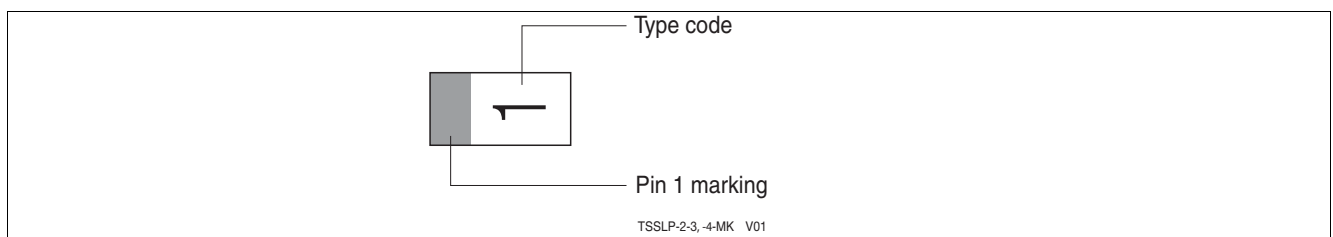

Figure 13 TSSLP-2-3: Marking (example)

5.2 TSLP-2-19 (mm)[3]

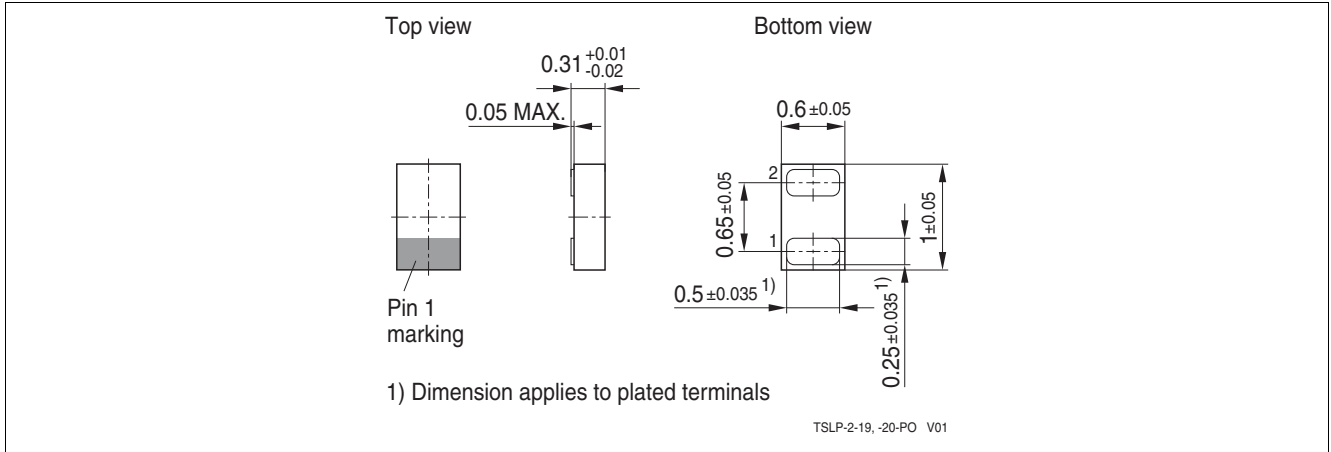

Figure 14 TSLP-2-19: Package Overview

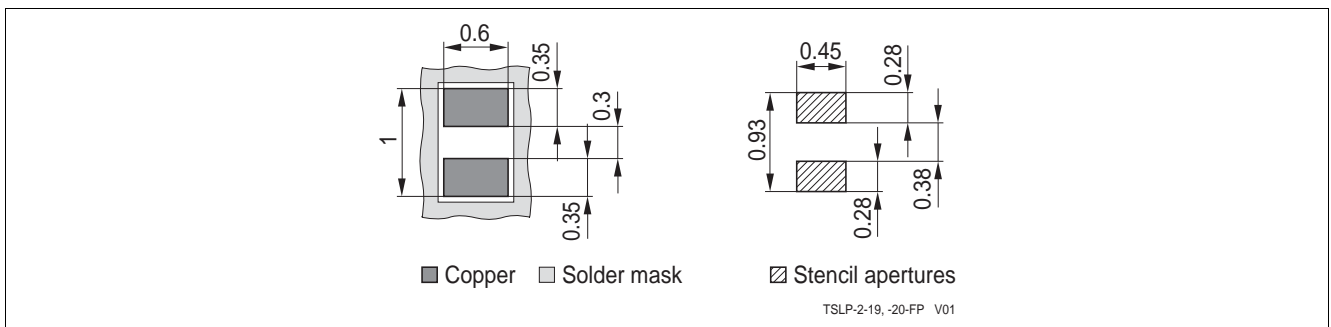

Figure 15 TSLP-2-19: Footprint

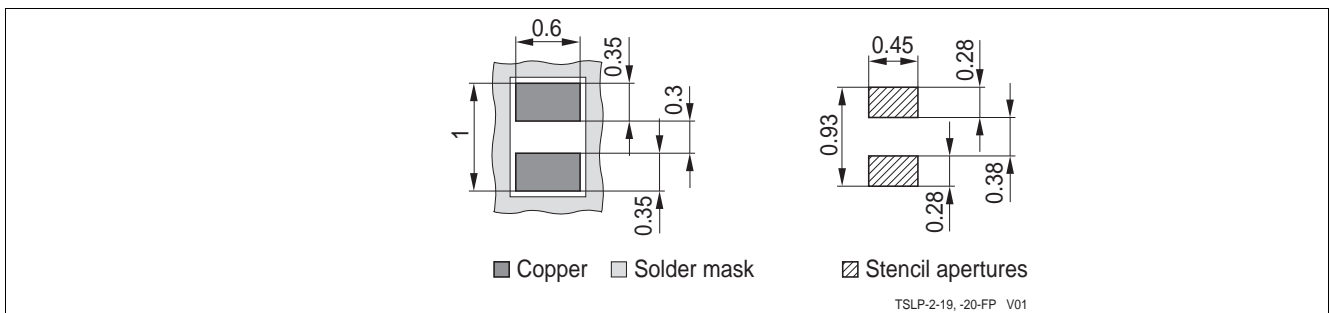

Figure 16 TSLP-2-19: Packing

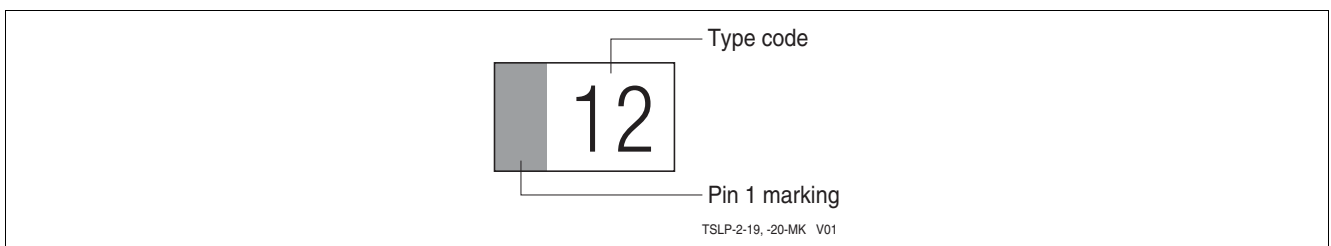

Figure 17 TSLP-2-19: Marking (example)

**References**

- [1] Infineon AG - **Application Note AN210**: Effective ESD Protection Design at System Level Using VF-TLP
- [2] Infineon AG - **Application Note AN140**: ESD Protection for Digital High-Speed Interfaces (HDMI, FireWire, ...) using ESD5V3U1U)
- [3] Infineon AG - Recommendations for PCB Assembly of Infineon TSLP and TSSLP Package

**Revision History: Rev.09, 2014-06-20**

Page or Item	Subjects (major changes since previous revision)
--------------	--

**Revision 1.0, 2014-10-30**

All	Status change to Final

**Trademarks of Infineon Technologies AG**

AURIX™, BlueMoon™, COMNEON™, C166™, CROSSAVE™, CanPAK™, CIPOST™, CoolMOS™, CoolSET™, CORECONTROL™, DAVE™, EasyPIM™, EconoBRIDGE™, EconoDUAL™, EconoPACK™, EconoPIM™, EiceDRIVER™, EUPEC™, FCOS™, HITFET™, HybridPACK™, ISOFACE™, I<sup>2</sup>RF™, IsoPACK™, MIPAQ™, ModSTACK™, my-d™, NovalithIC™, OmniTune™, OptiMOS™, ORIGA™, PROFET™, PRO-SIL™, PRIMARION™, PrimePACK™, RASIC™, ReverSave™, SatRIC™, SIEGET™, SINDRION™, SMARTi™, SmartLEWIS™, TEMPFET™, thinQ!™, TriCore™, TRENCHSTOP™, X-GOLD™, XMM™, X-PMU™, XPOSSYS™.

**Other Trademarks**

Advance Design System™ (ADS) of Agilent Technologies, AMBA™, ARM™, MULTI-ICE™, PRIMECELL™, REALVIEW™, THUMB™ of ARM Limited, UK. AUTOSAR™ is licensed by AUTOSAR development partnership. Bluetooth™ of Bluetooth SIG Inc. CAT-iq™ of DECT Forum. COLOSSUS™, FirstGPS™ of Trimble Navigation Ltd. EMV™ of EMVCo, LLC (Visa Holdings Inc.). EPCOS™ of Epcos AG. FLEXGO™ of Microsoft Corporation. FlexRay™ is licensed by FlexRay Consortium. HYPERTERMINAL™ of Hilgraeve Incorporated. IEC™ of Commission Electrotechnique Internationale. IrDA™ of Infrared Data Association Corporation. ISO™ of INTERNATIONAL ORGANIZATION FOR STANDARDIZATION. MATLAB™ of MathWorks, Inc. MAXIM™ of Maxim Integrated Products, Inc. MICROTEC™, NUCLEUS™ of Mentor Graphics Corporation. Mifare™ of NXP. MIPI™ of MIPI Alliance, Inc. MIPS™ of MIPS Technologies, Inc., USA. muRata™ of MURATA MANUFACTURING CO., MICROWAVE OFFICE™ (MWO) of Applied Wave Research Inc., OmniVision™ of OmniVision Technologies, Inc. Openwave™ Openwave Systems Inc. RED HAT™ Red Hat, Inc. RFMD™ RF Micro Devices, Inc. SIRIUS™ of Sirius Sattelite Radio Inc. SOLARIS™ of Sun Microsystems, Inc. SPANSION™ of Spansion LLC Ltd. Symbian™ of Symbian Software Limited. TAIYO YUDEN™ of Taiyo Yuden Co. TEAKLITE™ of CEVA, Inc. TEKTRONIX™ of Tektronix Inc. TOKO™ of TOKO KABUSHIKI KAISHA TA. UNIX™ of X/Open Company Limited. VERILOG™, PALLADIUM™ of Cadence Design Systems, Inc. VLYNQ™ of Texas Instruments Incorporated. VXWORKS™, WIND RIVER™ of WIND RIVER SYSTEMS, INC. ZETEX™ of Diodes Zetex Limited.

Last Trademarks Update 2010-06-09

[www.infineon.com](http://www.infineon.com)

Published by Infineon Technologies AG

## X-ON Electronics

Largest Supplier of Electrical and Electronic Components

*Click to view similar products for [ESD Suppressors / TVS Diodes](#) category:*

*Click to view products by [Infineon](#) manufacturer:*

Other Similar products are found below :

[60KS200C](#) [D12V0H1U2WS-7](#) [D18V0L1B2LP-7B](#) [82356050220](#) [D5V0F4U5P5-7](#) [D5V0M5U6V-7](#) [NTE4902](#) [P4KE27CA](#) [P6KE11CA](#)  
[P6KE39CA-TP](#) [P6KE8.2A](#) [SA110CA](#) [SA60CA](#) [SA64CA](#) [SMBJ12CATR](#) [SMBJ8.0A](#) [SMLJ30CA-TP](#) [ESD112-B1-02EL E6327](#)  
[ESD119B1W01005E6327XTSA1](#) [ESD5V0J4-TP](#) [ESD5V0L1B02VH6327XTSA1](#) [ESD7451N2T5G](#) [19180-510](#) [CPDT-5V0USP-HF](#)  
[3.0SMCJ33CA-F](#) [3.0SMCJ36A-F](#) [HSPC16701B02TP](#) [D3V3Q1B2DLP3-7](#) [D55V0M1B2WS-7](#) [DESD5V0U1BL-7B](#) [DRTR5V0U4SL-7](#)  
[SCM1293A-04SO](#) [ESD203-B1-02EL E6327](#) [SM12-7](#) [SMF8.0A-TP](#) [SMLJ45CA-TP](#) [CEN955 W/DATA](#) [82350120560](#) [82356240030](#)  
[VESD12A1A-HD1-GS08](#) [CPDUR5V0R-HF](#) [CPDUR24V-HF](#) [CPDQC5V0U-HF](#) [CPDQC5V0USP-HF](#) [CPDQC5V0-HF](#) [D1213A-01LP4-7B](#)  
[D1213A-02WL-7](#) [ESDLIN1524BJ-HQ](#) [5KP100A](#) [5KP15A](#)