

ESD119-B1-W01005

Protection device

TVS (transient voltage suppressor)

Bi-directional, 5.5 V, 0.2 pF, 01005, RoHS and halogen free compliant

Feature list

- ESD/transient protection of high speed data lines according to:
 - IEC61000-4-2 (ESD): ± 25 kV (air/contact discharge)
 - IEC61000-4-4 (EFT): ± 2.5 kV/ ± 50 A (5/50 ns)
 - IEC61000-4-5 (Surge): ± 2.5 A (8/20 μ s)
- Bi-directional working voltage up to: $V_{RWM} = \pm 5.5$ V
- Line capacitance: $C_L = 0.2$ pF (typical) at $f = 1$ MHz
- Clamping voltage: $V_{CL} = 20$ V (typical) at $I_{TLP} = 16$ A with $R_{DYN} = 0.8 \Omega$ (typical)
- Very low reverse current: $I_R < 1$ nA (typical)
- Small form factor SMD size 01005, low profile (0.43 mm x 0.23 mm x 0.15 mm) [3]
- Bi-directional, symmetric I/V characteristic for optimized design and assembly, recommendations for PCB assembly see [2]



Potential applications

- USB 2.0/3.0, Firewire, DVI, HDMI, S-ATA, DisplayPort
- Mobile HDMI link, MDDI, MIPI, SWP/NFC

Product validation

Qualified for industrial applications according to the relevant tests of JEDEC47/20/22

Device information

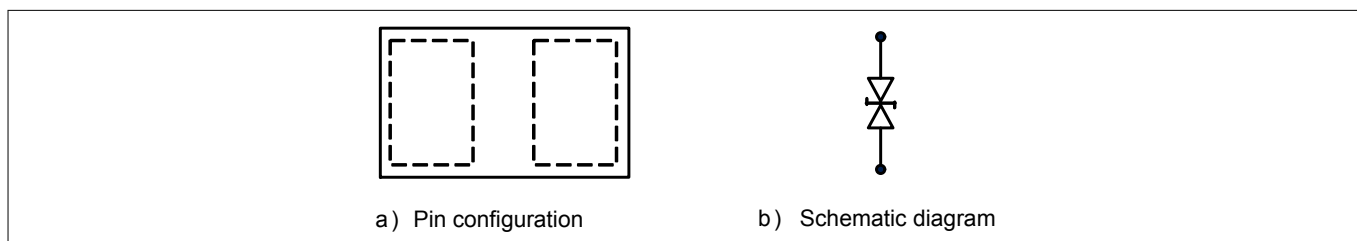

Figure 1 Pin configuration and schematic diagram

Table 1 Part information

Type	Package	Configuration	Marking code
ESD119-B1-W01005	WLL-2-2	1 line, bi-directional	C ¹⁾

¹ The device has no marking on the device backside. The marking code is on pad side.

Table of contents

	Feature list	1
	Potential applications	1
	Product validation	1
	Device information	1
	Table of contents	2
1	Maximum ratings	3
2	Electrical characteristics	4
3	Typical characteristic diagrams	6
4	Package information	12
4.1	WLL-2-2 package	12
5	References	13
	Revision history	13
	Disclaimer	14

Maximum ratings

1 Maximum ratings

Note: $T_A = 25\text{ °C}$, unless otherwise specified.

Table 2 Maximum ratings

Parameter	Symbol	Values	Unit
Reverse working voltage	V_{RWM}	±5.5	V
ESD (air/contact) discharge ¹⁾	V_{ESD}	±25	kV
Peak pulse power ²⁾	P_{PK}	35	W
Peak pulse current ²⁾	I_{PP}	±2.5	A
Operating temperature range	T_{OP}	-55 to 125	°C
Storage temperature	T_{stg}	-65 to 150	°C

Attention: Stresses above the maximum values listed here may cause permanent damage to the device. Exposure to absolute maximum rating conditions for extended periods may affect device reliability. Maximum ratings are absolute ratings. Exceeding only one of these values may cause irreversible damage to the component.

¹ V_{ESD} according to IEC61000-4-2 (R = 330 Ω, C = 150 pF discharge network)

² Stress pulse: 8/20 μs current waveform according to IEC61000-4-5

Electrical characteristics

2 Electrical characteristics

Note: $T_A = 25\text{ }^\circ\text{C}$, unless otherwise specified. Device is electrically symmetrical.

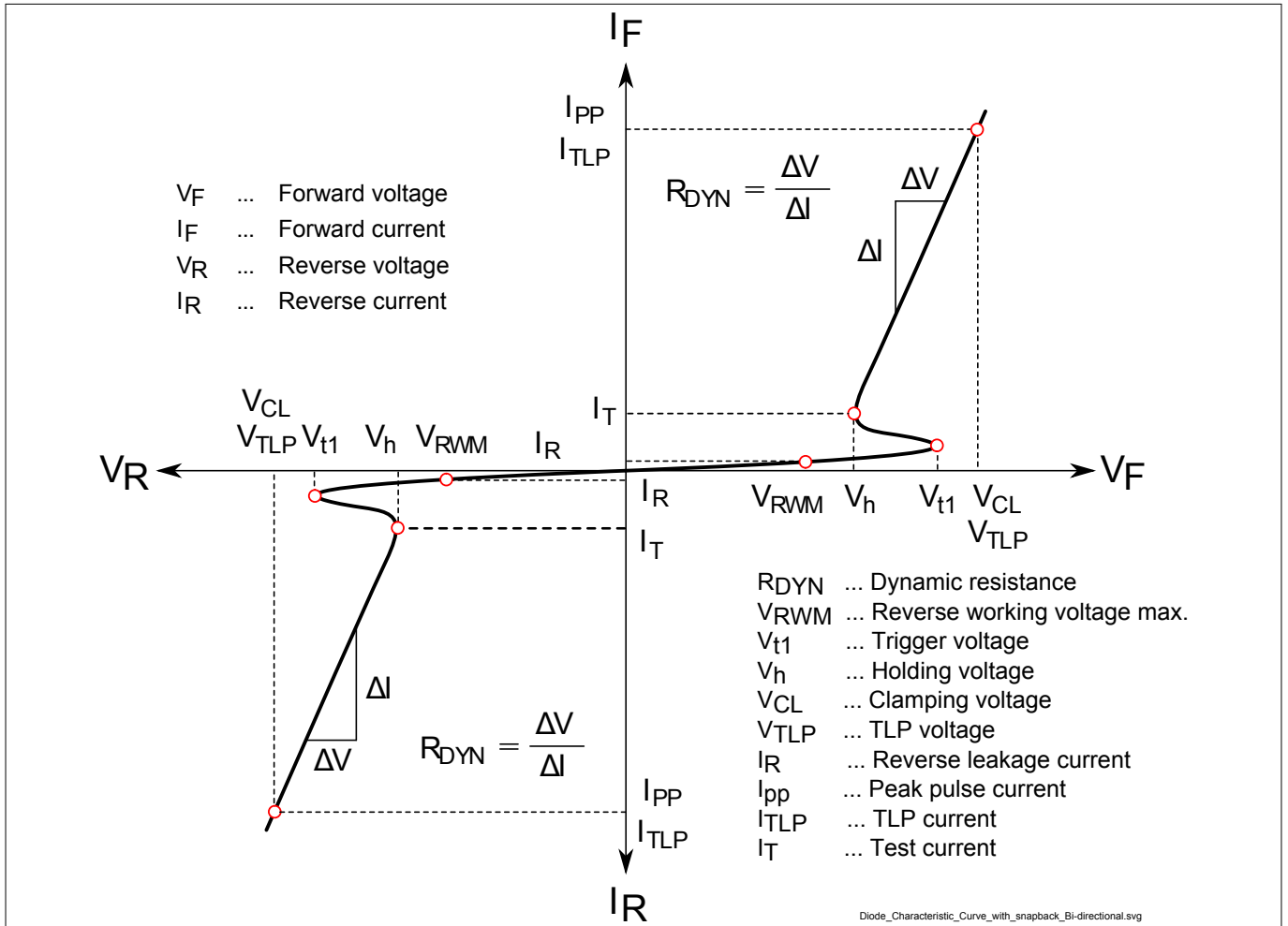

Figure 2 Definitions of electrical characteristics

Electrical characteristics

Table 3 DC characteristics

Parameter	Symbol	Values			Unit	Note or test condition
		Min.	Typ.	Max.		
Trigger voltage ¹⁾²⁾	V_{t1}	6.1	9	10.5	V	–
Holding voltage ³⁾	V_h	6.1	7.5	9.5	V	$I_T = 10 \text{ mA}$
Reverse current	I_R	–	<1	20	nA	$V_R = 5.5 \text{ V}$

Table 4 AC characteristics

Parameter	Symbol	Values			Unit	Note or test condition
		Min.	Typ.	Max.		
Line capacitance	C_L	–	0.2	0.3	pF	$V_R = 0 \text{ V}, f = 1 \text{ MHz}$
		–	0.15	–		$V_R = 0 \text{ V}, f = 1 \text{ GHz}$

Table 5 ESD and Surge characteristics

Parameter	Symbol	Values			Unit	Note or test condition
		Min.	Typ.	Max.		
Clamping voltage ⁴⁾	V_{CL}	–	20	23	V	$I_{TLP} = 16 \text{ A}, t_p = 100 \text{ ns}$
		–	31	34		$I_{TLP} = 30 \text{ A}, t_p = 100 \text{ ns}$
Clamping voltage ⁵⁾		–	8	11		$I_{PP} = 1 \text{ A}, t_p = 8/20 \mu\text{s}$
		–	11	14		$I_{PP} = 2.5 \text{ A}, t_p = 8/20 \mu\text{s}$
Dynamic resistance ⁴⁾	R_{DYN}	–	0.8	–	Ω	$t_p = 100 \text{ ns}$

1 Verified by design

2 Voltage forced

3 Current forced

4 Please refer to application note AN210 [1], TLP parameters: $Z_0 = 50 \Omega$, $t_p = 100 \text{ ns}$, $t_r = 0.6 \text{ ns}$

5 Stress pulse: 8/20 μs current waveform according to IEC61000-4-5

Typical characteristic diagrams

3 Typical characteristic diagrams

Note: $T_A = 25\text{ }^\circ\text{C}$, unless otherwise specified.

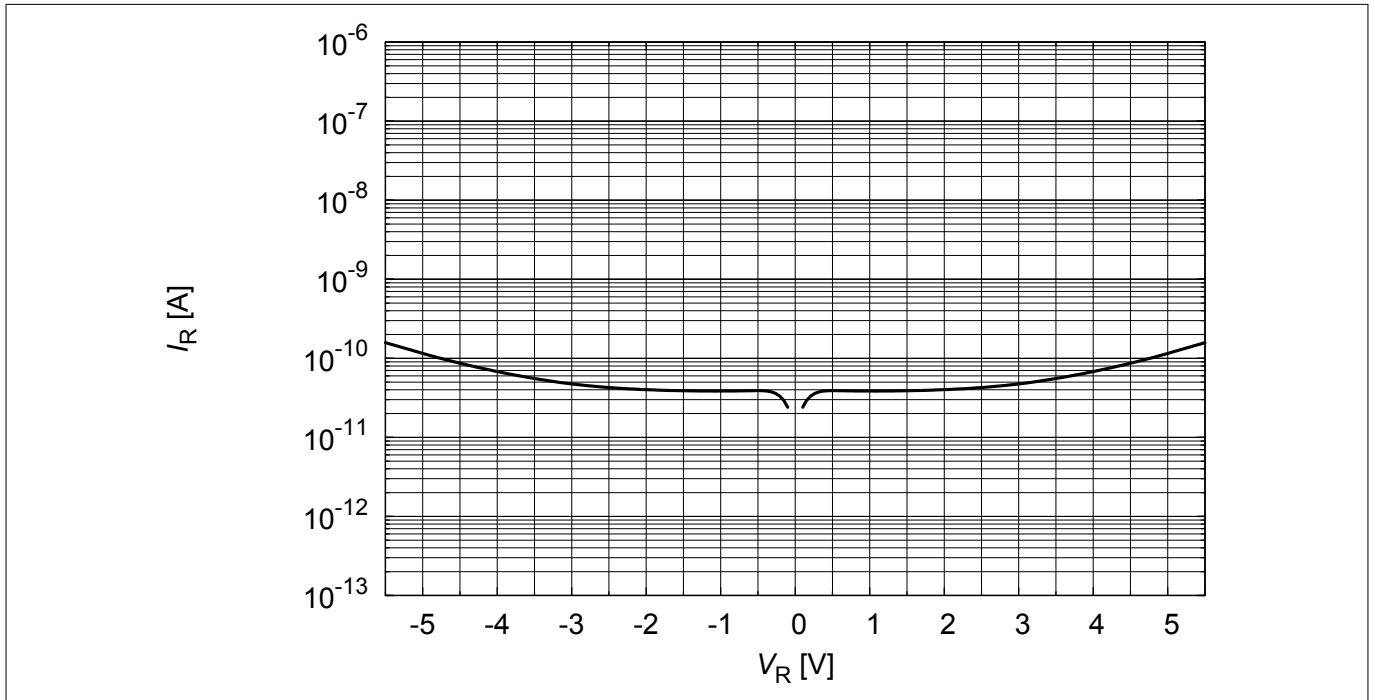

Figure 3 Reverse leakage current: $I_R = f(V_R)$

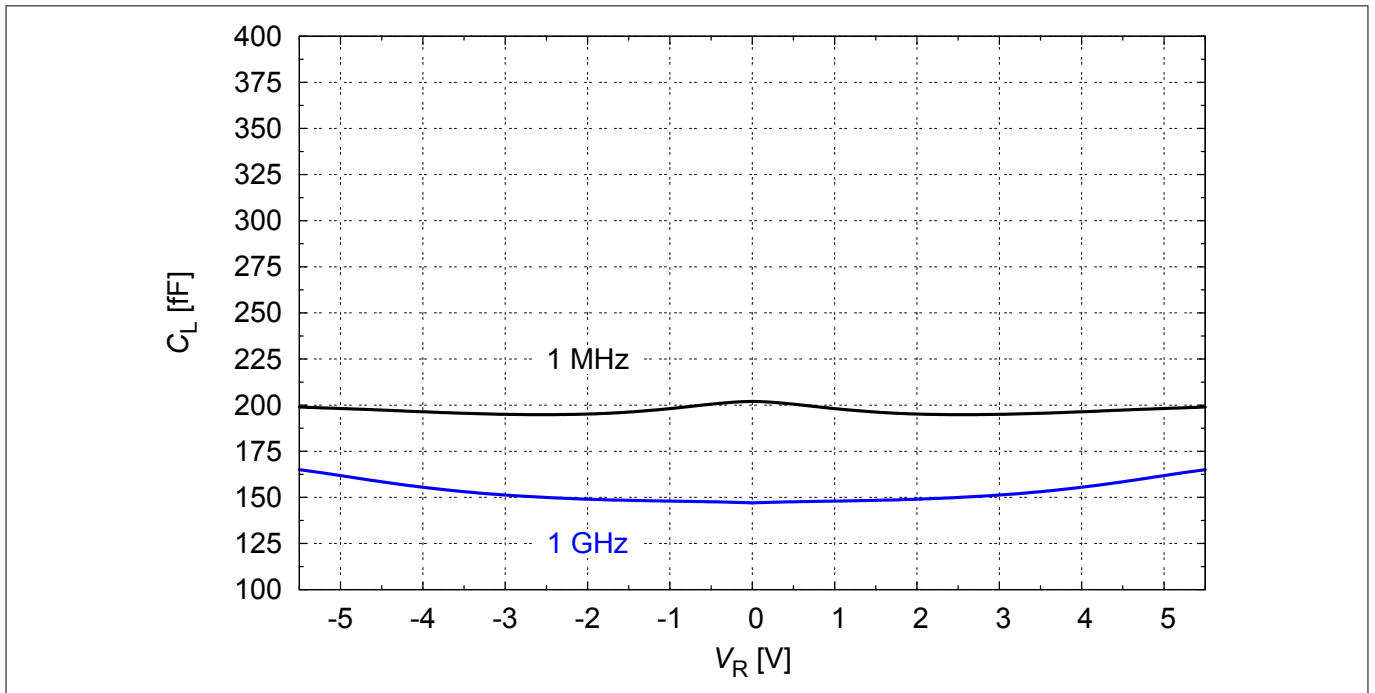

Figure 4 Line capacitance: $C_L = f(V_R)$, $f = 1\text{ MHz}, 1\text{ GHz}$

Typical characteristic diagrams

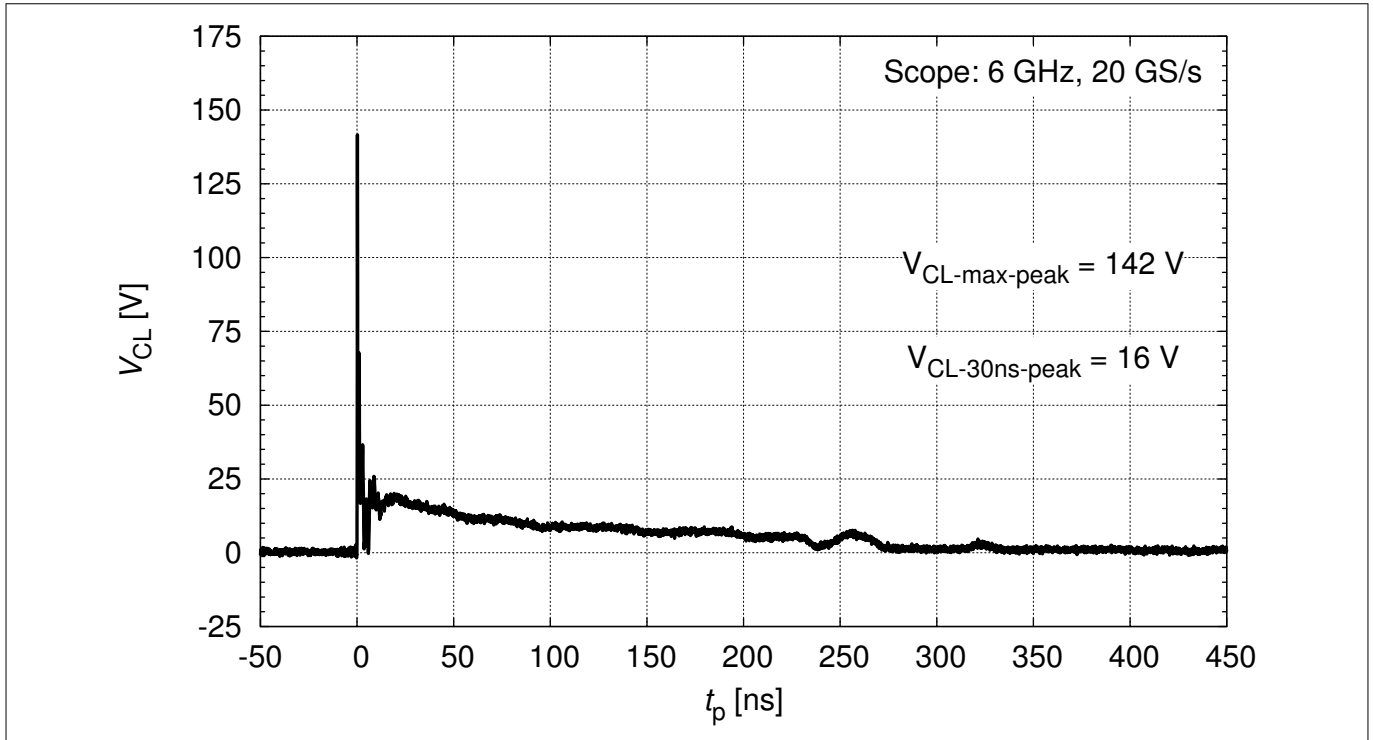

Figure 5 Clamping voltage (ESD): $V_{CL} = f(t)$, 8 kV positive pulse (according to IEC61000-4-2)

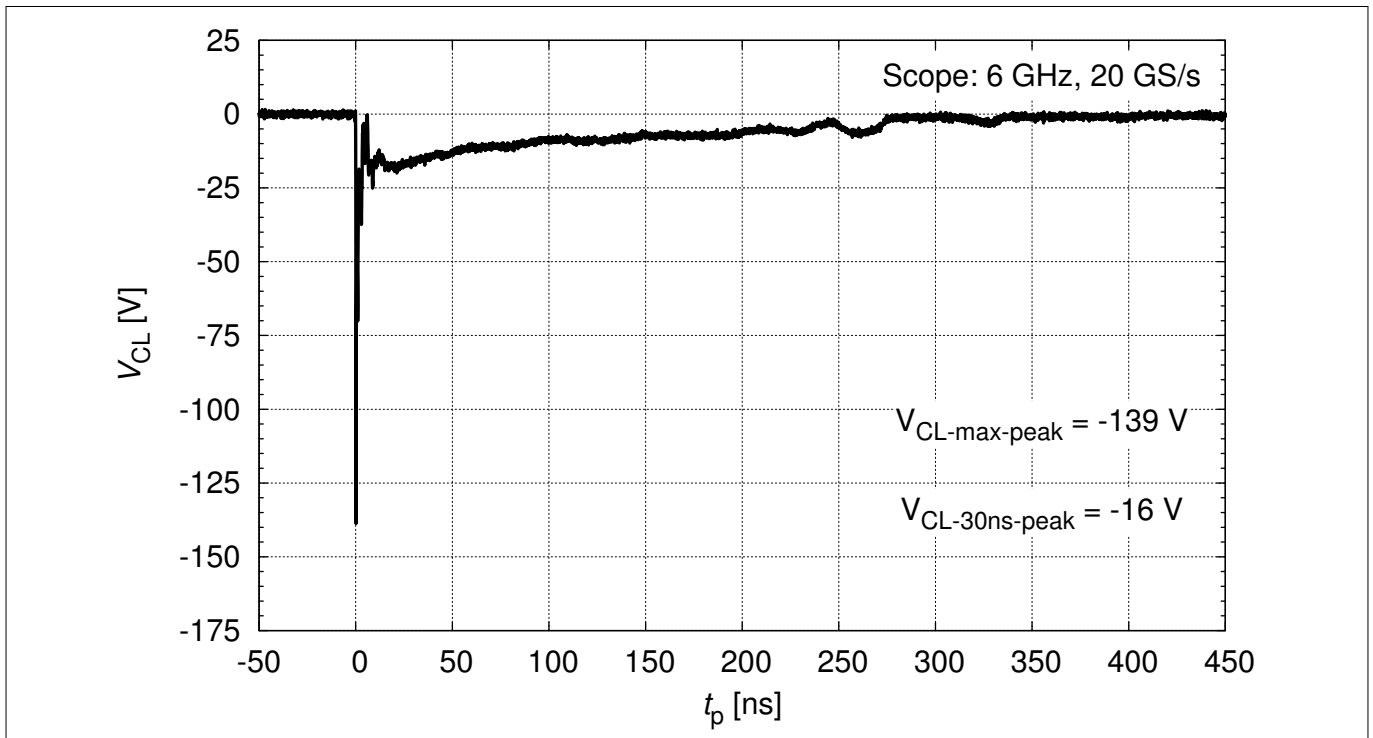

Figure 6 Clamping voltage (ESD): $V_{CL} = f(t)$, 8 kV negative pulse (according to IEC61000-4-2)

Typical characteristic diagrams

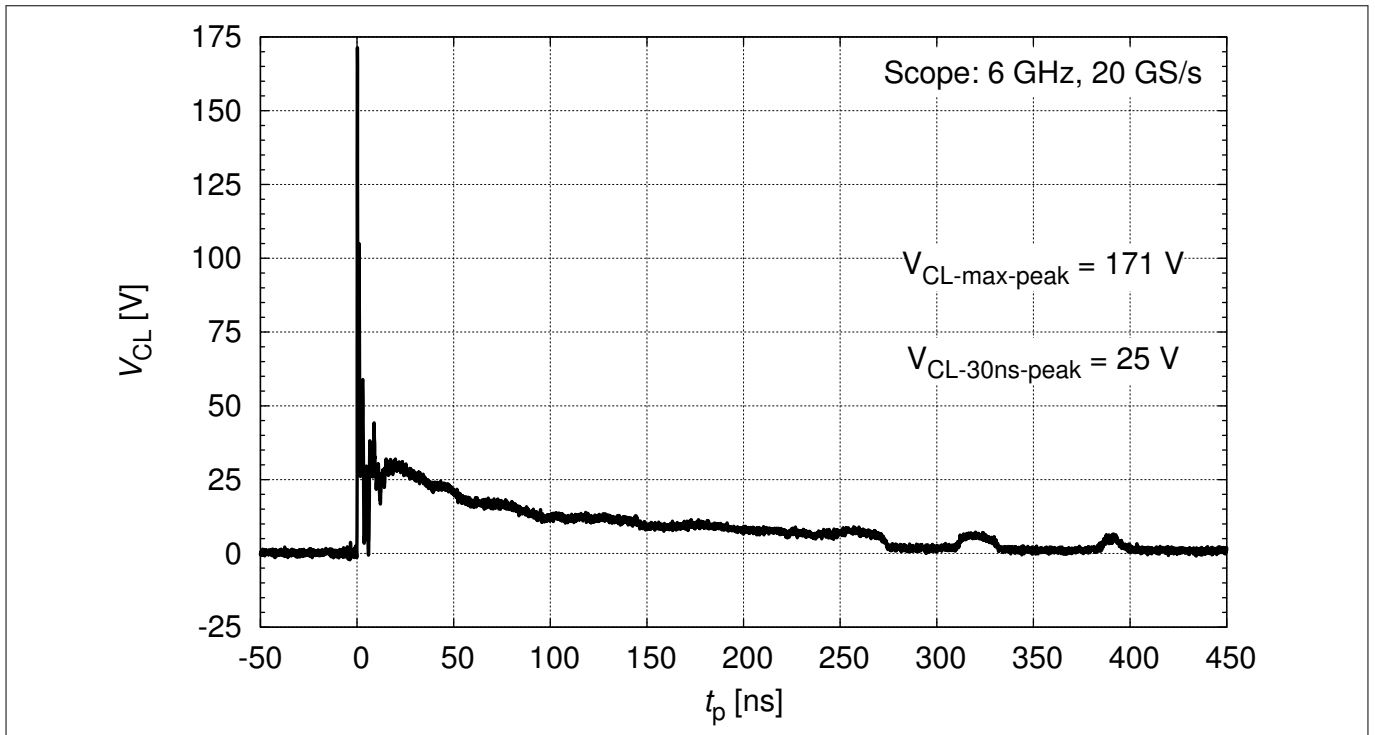

Figure 7 Clamping voltage (ESD): $V_{CL} = f(t)$, 15 kV positive pulse (according to IEC61000-4-2)

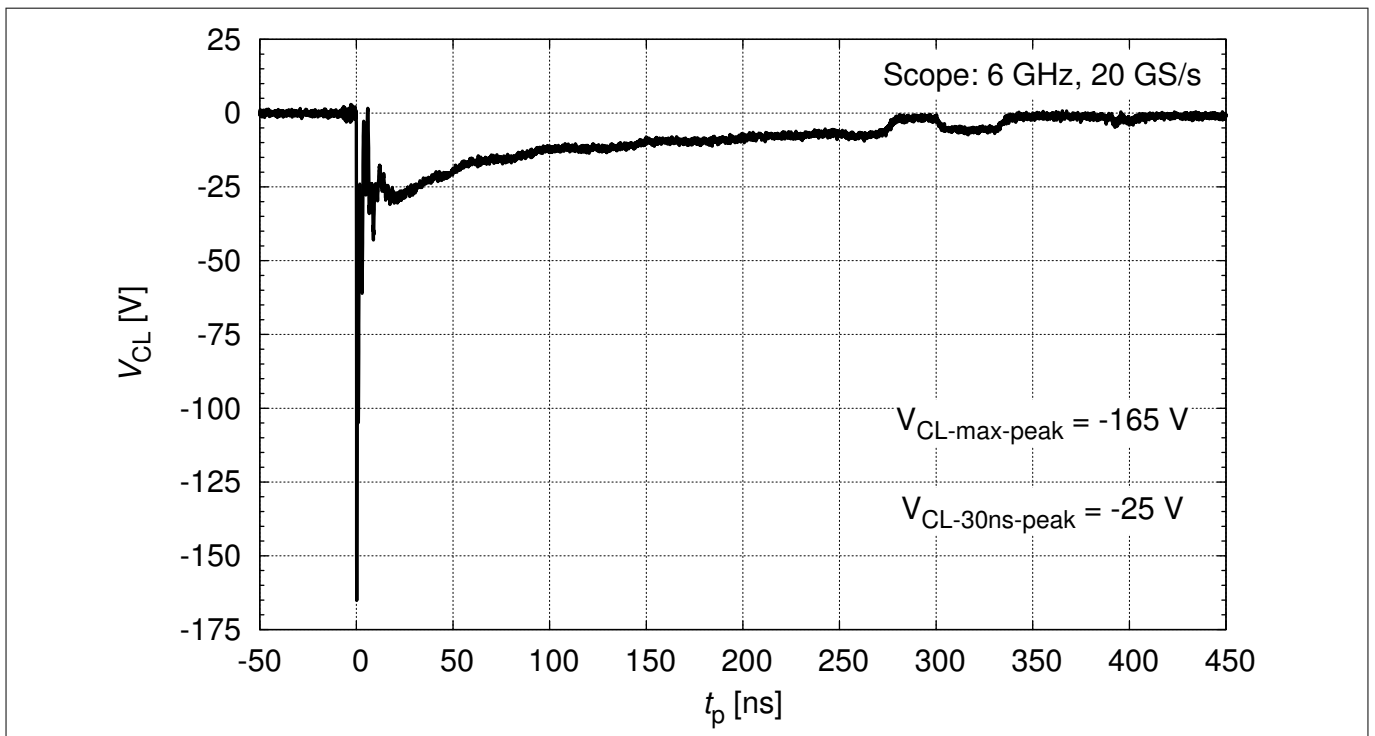

Figure 8 Clamping voltage (ESD): $V_{CL} = f(t)$, 15 kV negative pulse (according to IEC61000-4-2)

Typical characteristic diagrams

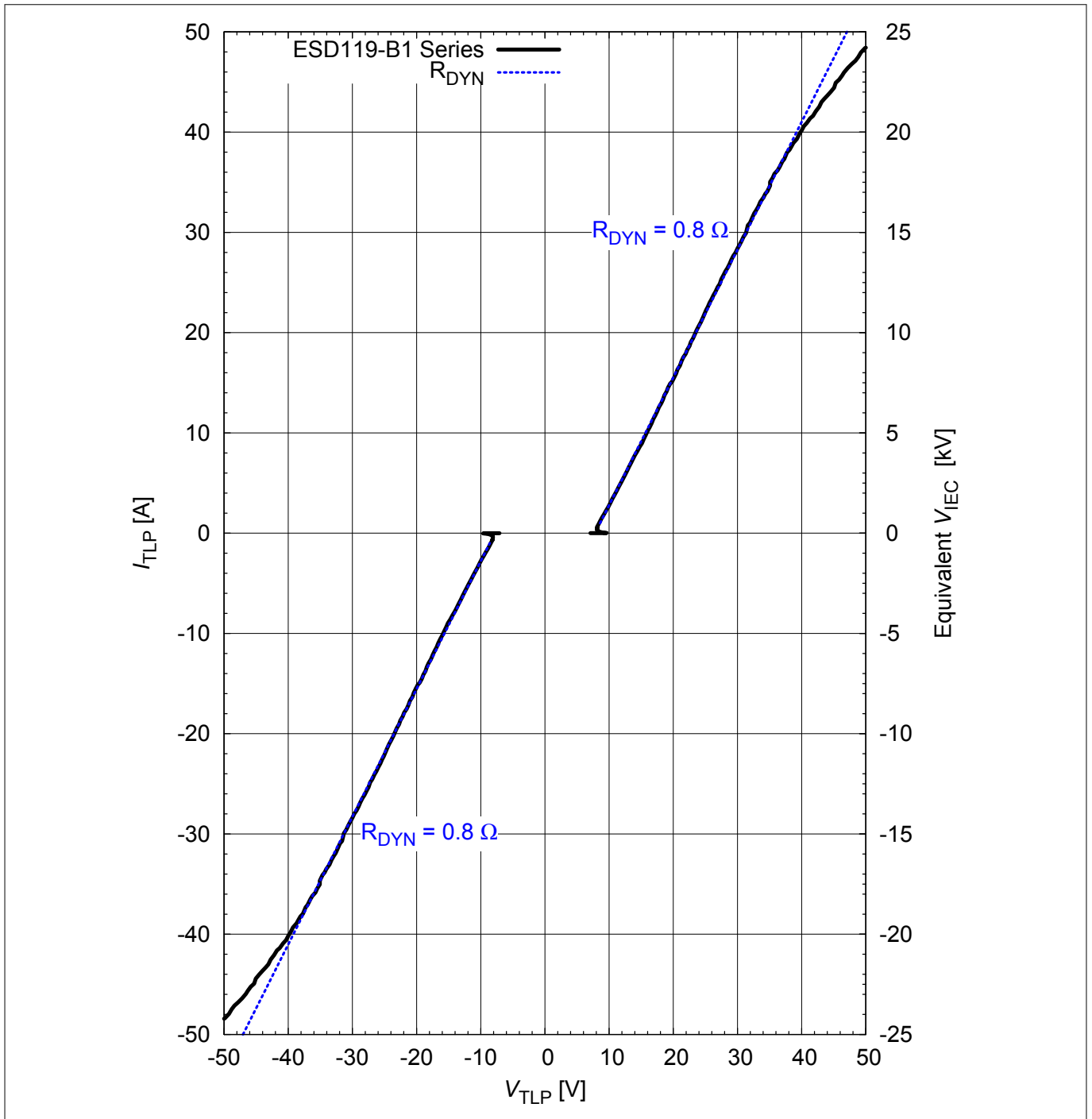

Figure 9 Clamping voltage (TLP): $I_{TLP} = f(V_{TLP})$ [1]

Typical characteristic diagrams

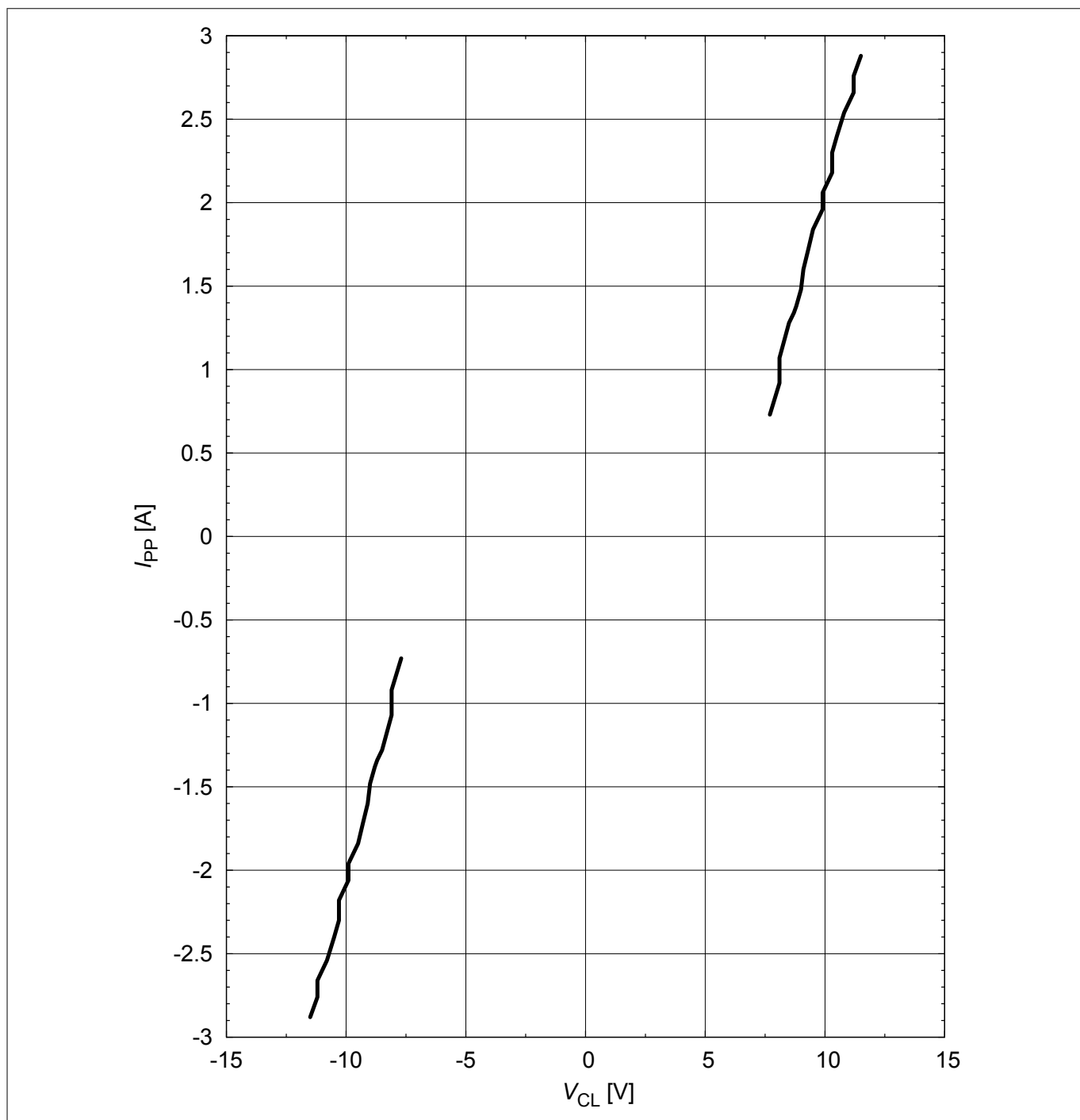

Figure 10 Clamping voltage (Surge): $I_{PP} = f(V_{CL})$ (according to IEC61000-4-5) [1]

Typical characteristic diagrams

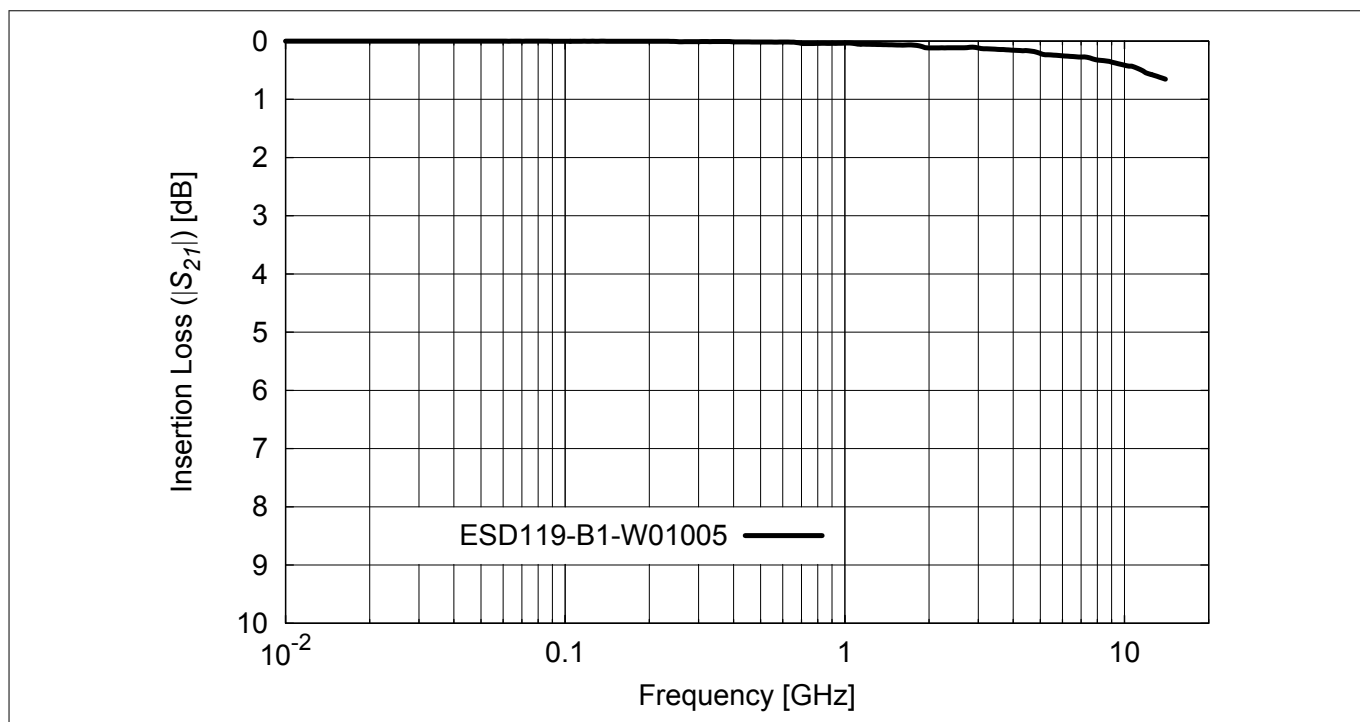

Figure 11 Insertion loss vs. frequency in a 50 Ω system

Package information

4 Package information

4.1 WLL-2-2 package

Note: Dimensions in mm.

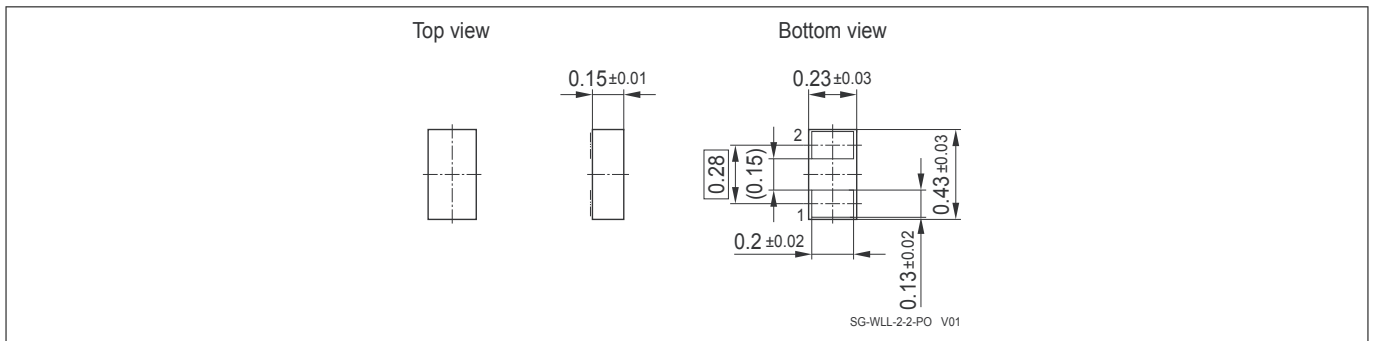

Figure 12 WLL-2-2 package outline

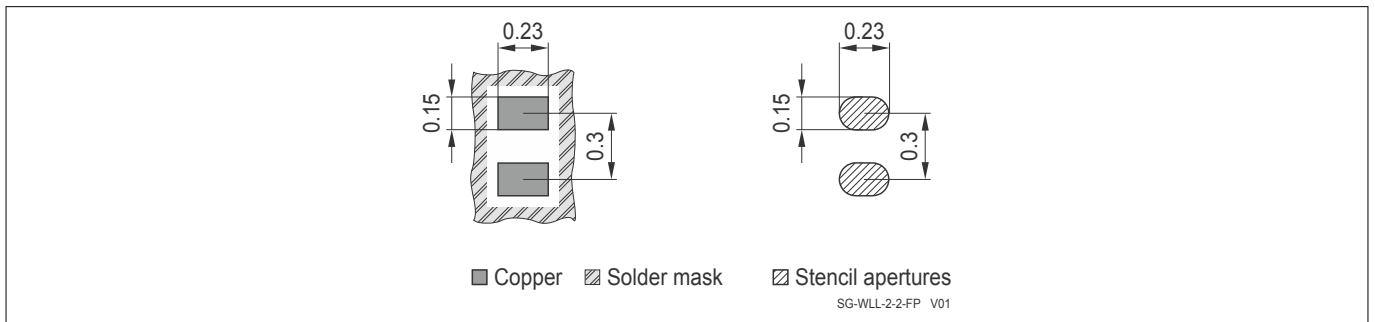

Figure 13 WLL-2-2 footprint

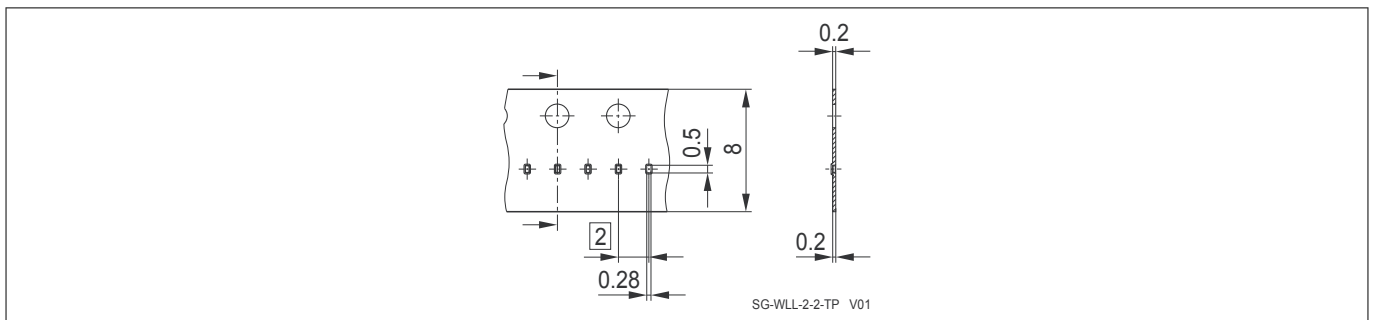

Figure 14 WLL-2-2 packing

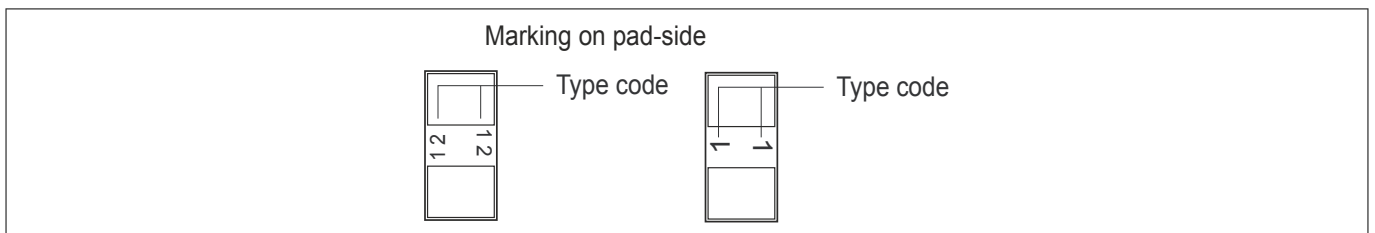

Figure 15 WLL-2-2 marking example (marking code see [Device information](#))

References

5 References

- [1] Infineon AG - **Application note AN210**: Effective ESD protection design at system level using VF-TLP characterization methodology
- [2] Infineon AG - **Recommendations for Printed Circuit Board Assembly of Infineon WLL Packages**
http://www.infineon.com/Packageinformation_WLL
- [3] Infineon AG - **Application note AN392**: TVS diodes in ChipScalePackage reduce size and save cost

Revision history

Revision history: Rev 1.3, 2017-10-17

Page or Item	Subjects (major changes since previous revision)
Revision 1.4, 2018-03-21	
Chapter 2	Max value of electrical parameter V_{t1} added
All	Minor editorial changes

Trademarks

All referenced product or service names and trademarks are the property of their respective owners.

Edition 2018-03-21

Published by
Infineon Technologies AG
81726 Munich, Germany

© 2018 Infineon Technologies AG
All Rights Reserved.

Do you have a question about any
aspect of this document?
Email: erratum@infineon.com

Document reference
IFX-hbd1501242142845

IMPORTANT NOTICE

The information given in this document shall in no event be regarded as a guarantee of conditions or characteristics ("Beschaffheitsgarantie").

With respect to any examples, hints or any typical values stated herein and/or any information regarding the application of the product, Infineon Technologies hereby disclaims any and all warranties and liabilities of any kind, including without limitation warranties of non-infringement of intellectual property rights of any third party.

In addition, any information given in this document is subject to customer's compliance with its obligations stated in this document and any applicable legal requirements, norms and standards concerning customer's products and any use of the product of Infineon Technologies in customer's applications.

The data contained in this document is exclusively intended for technically trained staff. It is the responsibility of customer's technical departments to evaluate the suitability of the product for the intended application and the completeness of the product information given in this document with respect to such application.

WARNINGS

Due to technical requirements products may contain dangerous substances. For information on the types in question please contact your nearest Infineon Technologies office.

Except as otherwise explicitly approved by Infineon Technologies in a written document signed by authorized representatives of Infineon Technologies, Infineon Technologies' products may not be used in any applications where a failure of the product or any consequences of the use thereof can reasonably be expected to result in personal injury

X-ON Electronics

Largest Supplier of Electrical and Electronic Components

Click to view similar products for [ESD Suppressors / TVS Diodes](#) category:

Click to view products by [Infineon](#) manufacturer:

Other Similar products are found below :

[60KS200C](#) [D18V0L1B2LP-7B](#) [D5V0F4U5P5-7](#) [NTE4902](#) [P4KE27CA](#) [P6KE11CA](#) [P6KE8.2A](#) [SA60CA](#) [SA64CA](#) [SMBJ12CATR](#)
[SMBJ33CATR](#) [SMBJ6.5A](#) [SMBJ8.0A](#) [ESD101-B1-02ELS E6327](#) [ESD112-B1-02EL E6327](#) [ESD7451N2T5G](#) [19180-510](#) [CPDT-5V0USP-](#)
[HF](#) [3.0SMCJ33CA-F](#) [3.0SMCJ36A-F](#) [HSPC16701B02TP](#) [JANTX1N6126A](#) [D3V3Q1B2DLP3-7](#) [D55V0M1B2WS-7](#) [SCM1293A-04SO](#)
[ESD200-B1-CSP0201 E6327](#) [SM12-7](#) [CEN955 W/DATA](#) [VESD12A1A-HD1-GS08](#) [CPDQC5V0-HF](#) [D1213A-01LP4-7B](#) [ESD101-B1-02EL](#)
[E6327](#) [AOZ8808DI-03](#) [5KP15A](#) [5KP48A](#) [5KP90A](#) [ESD3V3D7-TP](#) [15KPA36A-LF](#) [P4KE56CA](#) [P4KE68A](#) [P4KE91CATR](#) [P6KE120A](#)
[P6KE13CA](#) [P6KE43CA](#) [P6KE6.8CA](#) [P6KE8.2](#) [P6SMBJ20CA](#) [JANTX1N6072A](#) [SR2835ESKG](#) [SA90CA](#)