

UG-2024-01 EVAL-2EP130R-VD evaluation board

User guide

EiceDRIVER™ Power EVAL-2EP130R-VD

Full-bridge transformer driver for isolated gate driver power supply for IGBT

About this document

Scope and purpose

This user guide is intended to provide information about the Infineon evaluation board EiceDRIVER™ Power EVAL-2EP130R-VD. It describes the start-up, measurements, and parameter adjustments of the 2EP1xxR (2EP100R, 2EP101R, 2EP110R, and 2EP130R) product family. The 2EP1xxR is a full-bridge transformer driver IC to design isolated gate driver supplies for IGBT and SiC MOSFETs.

Intended audience

This document is intended for electrical engineers who are knowledgeable about isolated gate driver supply with open loop architecture.

Evaluation board

This board is used for evaluating and measuring 2EP130R.

This user guide is intended to help adapt the evaluation board EVAL-2EP130R-VD to the supply needs of a large variety of switches. The board supports isolated supply voltages for two gate driver ICs, for example, a high-side and a low-side gate driver IC.

Note: *The PCB and auxiliary circuits are NOT optimized for final customer design.*

Important notice**Important notice**

“Evaluation Boards and Reference Boards” shall mean products embedded on a printed circuit board (PCB) for demonstration and/or evaluation purposes, which include, without limitation, demonstration, reference and evaluation boards, kits and design (collectively referred to as “Reference Board”).

Environmental conditions have been considered in the design of the Evaluation Boards and Reference Boards provided by Infineon Technologies. The design of the Evaluation Boards and Reference Boards has been tested by Infineon Technologies only as described in this document. The design is not qualified in terms of safety requirements, manufacturing and operation over the entire operating temperature range or lifetime.

The Evaluation Boards and Reference Boards provided by Infineon Technologies are subject to functional testing only under typical load conditions. Evaluation Boards and Reference Boards are not subject to the same procedures as regular products regarding returned material analysis (RMA), process change notification (PCN) and product discontinuation (PD).

Evaluation Boards and Reference Boards are not commercialized products, and are solely intended for evaluation and testing purposes. In particular, they shall not be used for reliability testing or production. The Evaluation Boards and Reference Boards may therefore not comply with CE or similar standards (including but not limited to the EMC Directive 2004/EC/108 and the EMC Act) and may not fulfill other requirements of the country in which they are operated by the customer. The customer shall ensure that all Evaluation Boards and Reference Boards will be handled in a way which is compliant with the relevant requirements and standards of the country in which they are operated.

The Evaluation Boards and Reference Boards as well as the information provided in this document are addressed only to qualified and skilled technical staff, for laboratory usage, and shall be used and managed according to the terms and conditions set forth in this document and in other related documentation supplied with the respective Evaluation Board or Reference Board.

It is the responsibility of the customer’s technical departments to evaluate the suitability of the Evaluation Boards and Reference Boards for the intended application, and to evaluate the completeness and correctness of the information provided in this document with respect to such application.

The customer is obliged to ensure that the use of the Evaluation Boards and Reference Boards does not cause any harm to persons or third party property.

The Evaluation Boards and Reference Boards and any information in this document is provided "as is" and Infineon Technologies disclaims any warranties, express or implied, including but not limited to warranties of non-infringement of third party rights and implied warranties of fitness for any purpose, or for merchantability.

Infineon Technologies shall not be responsible for any damages resulting from the use of the Evaluation Boards and Reference Boards and/or from any information provided in this document. The customer is obliged to defend, indemnify and hold Infineon Technologies harmless from and against any claims or damages arising out of or resulting from any use thereof.

Infineon Technologies reserves the right to modify this document and/or any information provided herein at any time without further notice.

Safety precautions

Safety precautions

Note: Please note the following warnings regarding the hazards associated with development systems.

Table 1 Safety precautions

	<p>Warning: The isolated output voltages provide a creepage/clearance of 4 mm between output 1 and output 2. Ensure proper protection and coverage in case of use for voltages above SELV level.</p>
	<p>Warning: The input to output isolation is built for reinforced applications. However the board has not a hipot-test and can therefore not be declared as proven reinforced isolation.</p>
	<p>Warning: Remove or disconnect power from the drive before you disconnect or reconnect wires, or perform maintenance work. Wait five minutes after removing power to discharge the bus capacitors. Do not attempt to service the drive until the bus capacitors have discharged to zero. Failure to do so may result in personal injury or death.</p>
	<p>Caution: The heat sink and device surfaces of the evaluation or reference board may become hot during testing. Hence, necessary precautions are required while handling the board. Failure to comply may cause injury.</p>
	<p>Caution: Only personnel familiar with the drive, power electronics and associated machinery should plan, install, commission and subsequently service the system. Failure to comply may result in personal injury and/or equipment damage.</p>
	<p>Caution: The evaluation or reference board contains parts and assemblies sensitive to electrostatic discharge (ESD). Electrostatic control precautions are required when installing, testing, servicing or repairing the assembly. Component damage may result if ESD control procedures are not followed. If you are not familiar with electrostatic control procedures, refer to the applicable ESD protection handbooks and guidelines.</p>
	<p>Caution: A drive that is incorrectly applied or installed can lead to component damage or reduction in product lifetime. Wiring or application errors such as undersizing the motor, supplying an incorrect or inadequate AC supply, or excessive ambient temperatures may result in system malfunction.</p>
	<p>Caution: The evaluation or reference board is shipped with packing materials that need to be removed prior to installation. Failure to remove all packing materials that are unnecessary for system installation may result in overheating or abnormal operating conditions.</p>

Table of contents

	About this document	1
	Important notice	2
	Safety precautions	3
	Table of contents	4
1	The board at a glance	5
2	System and functional description	8
2.1	Theory of the 2EP1xxR using voltage doubler topology	8
2.2	Getting started	10
2.3	Resistor based operating parameter adjustment	10
2.4	Bypass mode operation	11
3	System design	13
3.1	Schematics	13
3.2	Layout	13
3.3	Bill of material	14
3.4	Connector details	14
4	System performance	16
5	Additional information	20
	Revision history	21
	Disclaimer	22

1 The board at a glance

1 The board at a glance

This user guide (UG-2024-01) describes the evaluation board, EVAL-2EP130R-VD. This board has been designed as a validation board that can be used by design engineers to evaluate the family of full-bridge transformer driver ICs – 2EP1xxR.

The board includes all necessary components.

Details about the transformer driver IC is available in the datasheet of the EiceDRIVER™ Power 2EP1xxR family.

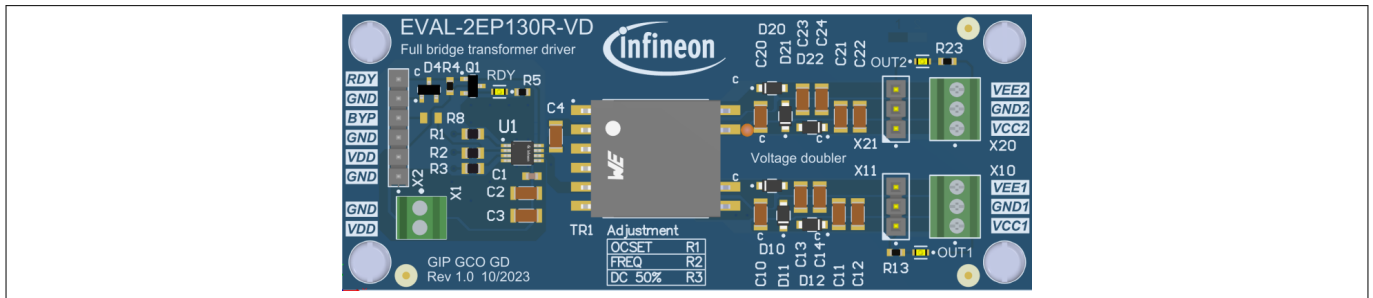

Figure 1 Evaluation board EVAL-2EP130R-VD

Delivery content

The delivery contains:

- One EVAL-2EP130R-VD, 90 × 37 mm² in size

Simplified schematic

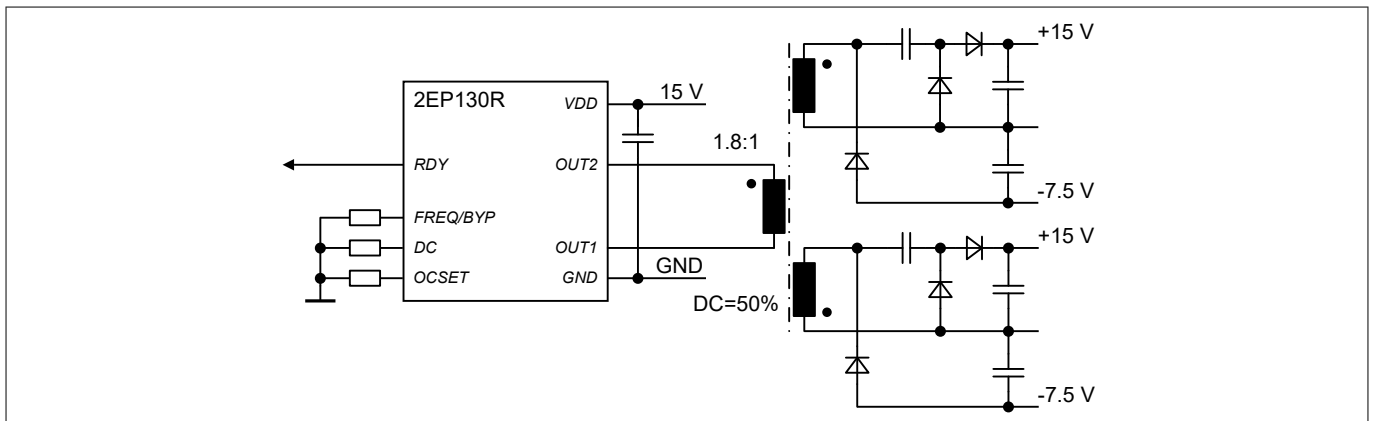

Figure 2 Voltage doubler schematic for 2EP130R

The simplified schematic shows a voltage doubler rectification for two separated rails, each with positive and negative output voltage.

Main features

The evaluation board, EVAL-2EP130R-VD, is designed for easy evaluation of the full-bridge transformer driver IC. The following table shows the product variants in the EiceDRIVER™ Power 2EP1xxR family and their differentiating features.

1 The board at a glance

Table 2 2EP1xxR product variants

Product name	Frequency	Duty cycle	Average overcurrent protection	Bypass input
2EP100R	66 kHz or 100 kHz	33% or 50%	Level 4	no
2EP101R	50 kHz or 66 kHz	12% or 17%	Level 4	no
2EP110R	50 kHz or 66 kHz	10% .. 50%	Level 4	no
2EP130R	50 kHz .. 695 kHz	10% .. 50%	Level 1-5	yes

All product variants are pin compatible and can be used with matching configuration settings in customer-specific designs. 2EP130R is pre-assembled on EVAL-2EP130R-VD for complete feature evaluation. The voltage doubler configuration only allows a duty cycle of 50%.

The evaluation board provides all the necessary supply, load, and signal connections for an application. It offers the following features:

- Wide input supply range V_{VDD} from 5 V to 20 V
- Output power of up to 5 W
- Dual isolated output supply rails with asymmetric output voltage in the ratio of 2:1 due to voltage doubler topology
- Wide frequency operating range from 50 kHz to 695 kHz using the internal oscillator or an external pulse width modulation (PWM)
- Adjustable overcurrent threshold
- Short circuit protection of power outputs
- Overtemperature protection
- *RDY* status output indication for normal operation

Board parameters and technical data

Parameters of the evaluation board, EVAL-2EP130R-VD, must respect the absolute maximum ratings listed below and should be operated within the recommended operating range.

Table 3 Absolute maximum ratings

Parameter	Symbol	Values		Unit	Note/conditions
		Min	Max		
Supply voltage	V_{VDD}	0	22	V	Referenced to <i>GND</i>
Positive output voltage	V_{VCC1}, V_{VCC2}	0	35	V	Limited by capacitor and diode voltage rating, referenced to <i>GND1/GND2</i>
Negative output voltage	V_{VEE1}, V_{VEE2}	-35	0	V	Limited by capacitor and diode voltage rating, referenced to <i>GND1/GND2</i>
Input to output/between output rails	V_{ISO}	-800	800	V	Functional isolation, no HiPot test performed
Output current	$I_{VCC1}, I_{VCC2}, I_{VEE1}, I_{VEE2}$	2	400	mA	Depending on configuration, limited by IC
<i>RDY</i> sink current	I_{RDY}	0	10	mA	Referenced to <i>GND</i>
<i>RDY</i> voltage	V_{RDY}	0	6.5	V	Referenced to <i>GND</i>

1 The board at a glance

Table 4 Recommended operating range

Parameter	Symbol	Values		Unit	Note/conditions
		Min	Max		
Supply voltage	V_{VDD}	5	20	V	Referenced to <i>GND</i> , depending on configuration
Positive output voltage	V_{VCC1}, V_{VCC2}	0	35	V	Limited by capacitor and diode voltage rating, referenced to <i>GND1/GND2</i>
Negative output voltage	V_{VEE1}, V_{VEE2}	-35	0	V	Limited by capacitor and diode voltage rating, referenced to <i>GND1/GND2</i>
Bypass signal voltage	V_{BYP}	0	5.5	V	Referenced to <i>GND</i>
Bypass signal frequency	f_{BYP}	50	695	kHz	Transformer dependent; use only with 50% duty cycle
Output current	$I_{VCC1}, I_{VCC2}, I_{VEE1}, I_{VEE2}$	2 ¹⁾	150	mA	Depending on configuration, limited by IC
<i>RDY</i> sink current	I_{RDY}	0	10	mA	Referenced to <i>GND</i>

1) minimal load for stable operation

2 System and functional description

2 System and functional description

2.1 Theory of the 2EP1xxR using voltage doubler topology

This section describes the theory behind the full-bridge power stage of 2EP1xxR together with the voltage doubler topology to provide two isolated output voltages. Each transformer output winding supports a positive and negative output voltage. The positive output voltage has double the voltage level compared to the negative output voltage.

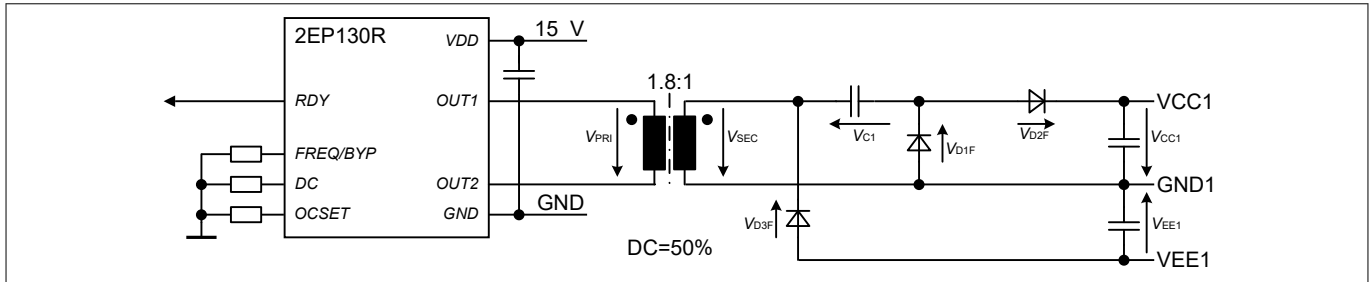

Figure 3 Simplified schematic of 2EP130R using voltage doubler topology

The voltage arrows indicate the polarity of the corresponding symbol used in the equations provided later. V_{PRI} and V_{SEC} represent the transformer voltages, V_{DXF} the individual diode forward voltages, V_{C1} the voltage of the voltage doubler capacitor (flying capacitor), and V_{CC1}/V_{EE1} the output voltage of one of the rails.

The following sections describe how to determine the output voltages of a voltage doubler topology connected to 2EP130R.

Full-bridge transformer driver 2EP130R

For output rectification using the voltage doubler topology, the configured duty cycle needs to be at 50%. 2EP130R chops the applied supply voltage V_{DD} according to the configured switching frequency. The output of $OUT1$ is switched between V_{DD} and GND . The same is valid for $OUT2$. However, its switching pattern is inverted. This results in twice the amplitude of V_{DD} across the outputs $V_{OUT1,2}$. In the schematic shown above, this voltage is referred to as primary transformer voltage V_{PRI} .

$$V_{PRI} = \pm V_{DD}$$

Transformer, transformer turn ratio (TTR), and transformer saturation

The transformer transforms the primary input voltage, V_{PRI} , to the secondary side voltage based on the transformer turn ratio (TTR). The secondary transformer voltage V_{SEC} is calculated as:

$$V_{SEC} = \frac{V_{PRI}}{TTR} = \pm \frac{V_{DD}}{TTR}$$

If the output voltages are loaded asymmetrically or the input duty cycle is not exactly at 50%, the transformer could drift into saturation. The evaluation board EVAL-2EP130R-VD includes, therefore, a series capacitor between $OUT1$ and the primary winding. For the sake of simplification, this component is not shown nor considered in the calculations given in this section. This capacitor ensures an equal (voltage * time) value below and above the ground potential for primary winding. The equal (voltage * time) value prevents the transformer from saturating, even when driven with asymmetric loads.

Voltage doubler current rectification

Due to the diodes in the voltage doubler circuit, individual current paths must be considered separately and the matching voltage polarity of the secondary transformer voltage must be applied only when calculating the expected output capacitor voltages.

2 System and functional description

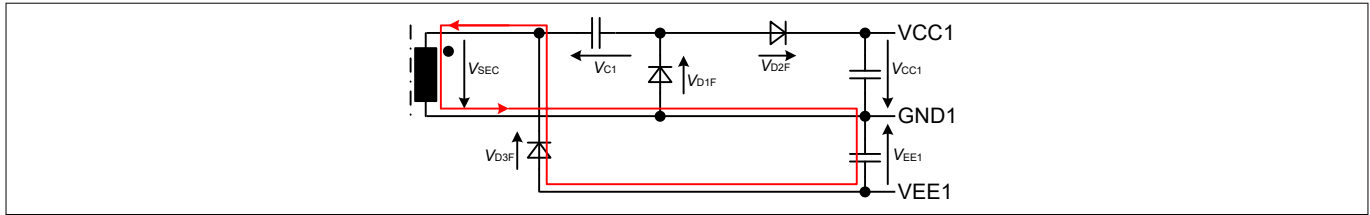

Figure 4 Current path of negative voltage rail

The current path to charge the negative voltage rail requires V_{SEC} to be in reverse polarity. The current charges the negative output voltage capacitor. The current then closes the circuit via diode D3 in the forward direction resulting in V_{D3F} voltage drop.

The negative output voltage results in: $V_{EE1} = V_{SEC(neg)} + V_{D3F}$

Since the secondary transformer voltage is negative at that half wave, the resulting output voltage is also negative but lowered by the diode forward voltage.

The positive output voltage requires a two-step approach for the full output voltage. In the first step, the flying capacitor is charged. In the second step, this precharged capacitor boosts the voltage for the positive output rail.

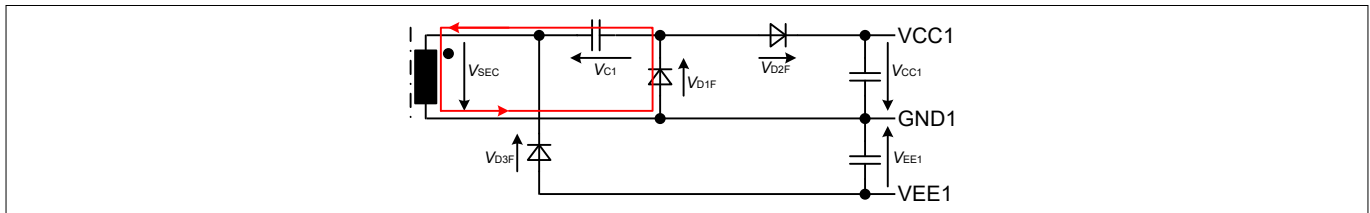

Figure 5 Current path to charge bootstrap capacitor of the positive voltage rail

The current path to charge the flying capacitor requires V_{SEC} to be in reverse polarity. The direction of current is the same as that for the negative output voltage. Therefore, the current during the negative half wave of the secondary winding is double that to the positive half wave. The current flows through the diode, D1, resulting in V_{D1F} voltage drop. It then charges the flying capacitor before closing the circuit.

The flying capacitor, therefore, has a positive voltage which results in: $V_{C1} = -V_{SEC(neg)} - V_{D1F}$

As the secondary transformer voltage is negative at that half wave, the resulting flying capacitor voltage, according to the indicated polarity, is positive but reduced by the diode forward voltage.

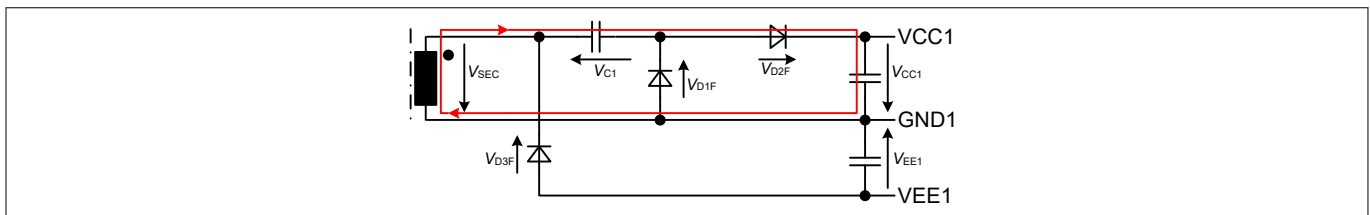

Figure 6 Current path of positive voltage rail via the bootstrap capacitor

The current path to finally charge the positive output voltage capacitor requires V_{SEC} to be in the indicated polarity (positive half wave). It has, therefore, the same polarity as the flying capacitor voltage, V_{C1} . The resulting current will pass through D2 resulting in V_{D2F} voltage drop. It then charges the positive output voltage capacitor before closing the circuit.

The positive output voltage results in: $V_{CC1} = V_{SEC(pos)} + V_{C1} - V_{D2F}$

Both output voltages can then be written as:

2 System and functional description

Assumption 1: All forward voltages are equal

$$V_F = V_{D1F} = V_{D2F} = V_{D3F}$$

Assumption 2: Amplitudes of positive and negative half wave are equal

$$|V_{SEC}| = V_{SEC(pos)} = -V_{SEC(neg)} = \frac{V_{DD}}{TRR}$$

positive output voltage

$$V_{CC1} = 2 \cdot \left(\frac{V_{DD}}{TRR} - V_F \right)$$

negative output voltage

$$V_{EE1} = - \left(\frac{V_{DD}}{TRR} - V_F \right)$$

(1)

Note: A single rail voltage doubler output has asymmetric current during positive and negative half waves. To compensate for this, when designing a voltage doubler circuit with dual output rails use different winding polarities for the two rails.

2.2 Getting started

This section describes the default board configuration and its power up.

Default configuration for 13.5 V input voltage

- Dual output voltage of +15 V/-7.5 V at 150 mA maximum output current
- Transformer turn ratio (TTR) 1.8:1:1
- OCset level 5 (output current limit at 350 mA on equally loaded output rails)
- Switching frequency 100 kHz, duty cycle 50%, internally generated

EVAL-2EP130R-VD power-up steps for default configuration

- Connect a load to the isolated transformer output terminals of the X10/X11 and X20/X21 connectors
 - Consider the polarities of $VCC1/GND1/VEE1$ and $VCC2/GND2/VEE2$
 - The LEDs OUT1 and OUT2 also act as a minimal base load; without external load, the output voltages will be higher than calculated
- Connect a 13.5 V positive supply voltage between VDD and GND at the corresponding terminals of the X1/X2 connectors
- The RDY LED indicated the ready status of the 2EP130R

After the supply voltage at VDD is applied, the 2EP130R performs a soft start. The voltages at the isolated outputs increase and the RDY status LED lights up. In case the status LED does not light up, the transformer driver is either not powered correctly, still in start-up (soft-start), or in fault mode (overcurrent or overtemperature).

2.3 Resistor based operating parameter adjustment

2EP130R offers three input pins to configure the switching frequency, the duty cycle, and the average overcurrent protection during an operation.

- Resistor $R1$ sets the overcurrent threshold at pin $OCSET$; default: $R1 = 47500 \Omega$, OCset level: 5
- Resistor $R2$ sets the frequency at pin $FREQ/BYP$; default: $R2 = 1540$, switching frequency: 97 kHz
- Resistor $R3$ sets the duty cycle at pin DC ; default: $R3 = 63400$, duty cycle: 50%, keep at 50% for the voltage doubler topology

2 System and functional description

You can use the following table to select an individual resistor value from the column **E96 series** and match it to OCSET, FREQ, and DC column values in the same row.

Table 5 Parameter adjustments of resistor value to functional value

Resistor	R1	R2	R3	Resistor	R1	R2	R3
E96 series	OCSET	FREQ	DC	E96 series	OCSET	FREQ	DC
Ω	–	kHz	%	Ω	–	kHz	%
332	1	50	10	5760	3	199	31
412	1	53	11	6980	3	213	32
499	1	57	12	8250	3	227	33
590	1	61	13	9530	4	243	34
698	1	65	14	11000	4	259	35
806	1	70	15	12700	4	277	36
931	1	74	16	14700	4	295	37
1070	1	79	17	16500	4	316	38
1210	2	85	18	18700	4	337	39
1370	2	90	19	21000	4	360	40
1540	2	97	20	23700	4	384	41
1740	2	103	21	26700	5	410	42
1960	2	110	22	30100	5	438	43
2210	2	118	23	34000	5	468	44
2490	2	126	24	38300	5	500	45
2800	2	134	25	42200	5	534	46
3160	3	143	26	47500	5	570	47
3480	3	153	27	52300	5	609	48
3920	3	163	28	57600	5	651	49
4320	3	175	29	63400	5	695	50
4750	3	186	30				

2.4 Bypass mode operation

2EP130R supports bypass mode operation. In this mode, 2EP130R follows an externally applied pulse width modulation (PWM) signal at *FREQ/BYP* pin for frequency and duty cycle during operation.

During start-up, the IC follows the internal soft start sequence. Therefore, the frequency and individual pulse length deviate from the externally applied PWM signal during the soft start. The applied switching frequency should be kept constant during start-up. The transformer driver syncs up with that frequency in the final moments of the start-up sequence. For further information, see EiceDRIVER™ 2EP1xxR family datasheet.

2 System and functional description

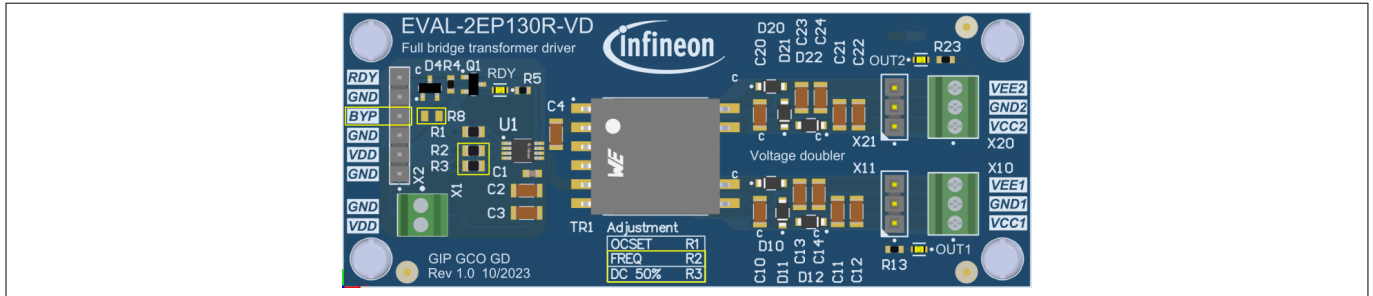

Figure 7 Modification for bypass mode operation

Modify the default assembly to operate the evaluation board in bypass mode:

- Resistor *R3* at *DC* pin: change to 0 Ω to enable bypass mode
- Resistor *R2* at *FREQ/BYP* pin: remove resistor
- Resistor *R8*: assemble 0 Ω resistor to connect the *X2.BYP* pin to the *FREQ/BYP* pin

Ensure that the external frequency stays within the 2EP130R frequency range and the duty cycle for this voltage doubler topology at 50%.

3 System design

3 System design

3.1 Schematics

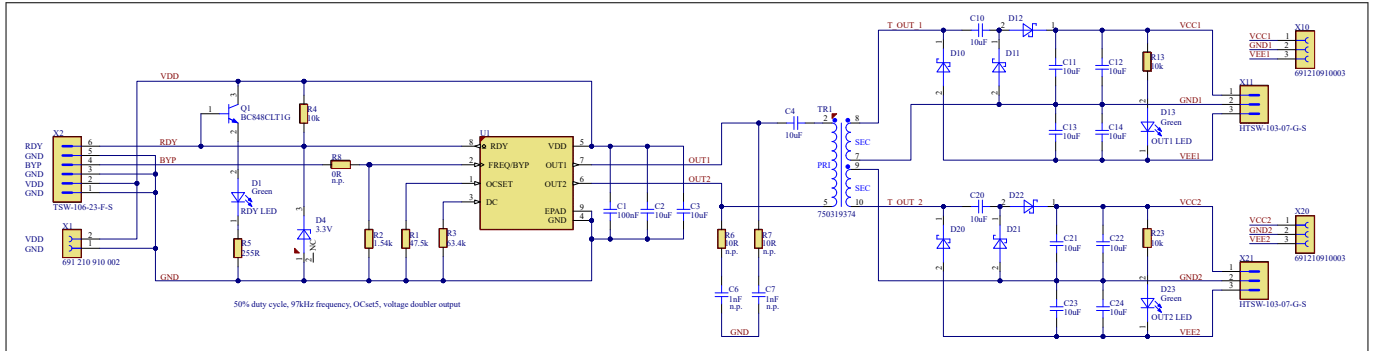

Figure 8 Schematic

The schematic uses default resistor values for average overcurrent setting level 5, a target switching frequency of 97 kHz and a duty cycle of 50%. An input voltage of 13.5 V will result in a positive output voltage of 15 V and a negative output voltage of -7.5 V.

3.2 Layout

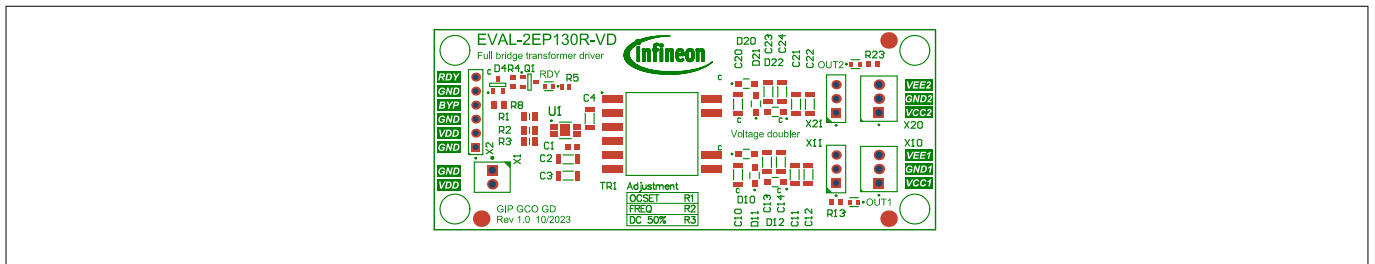

Figure 9 Component side assembly

The EVAL-2EP130R-VD evaluation board has an approximate size of 91 × 37 mm². The two-layer PCB uses a standard copper thickness of 1 oz. The top layer is used for routing, the bottom layer mainly consists of three GND planes. A single layer design is possible.

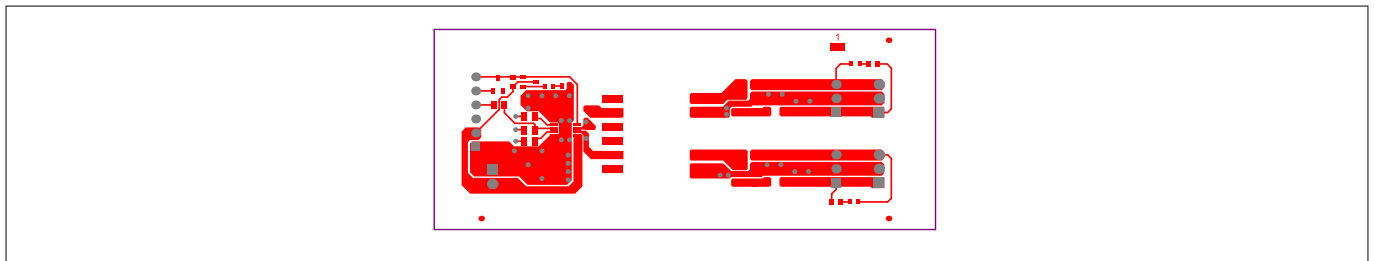

Figure 10 Top layer

3 System design

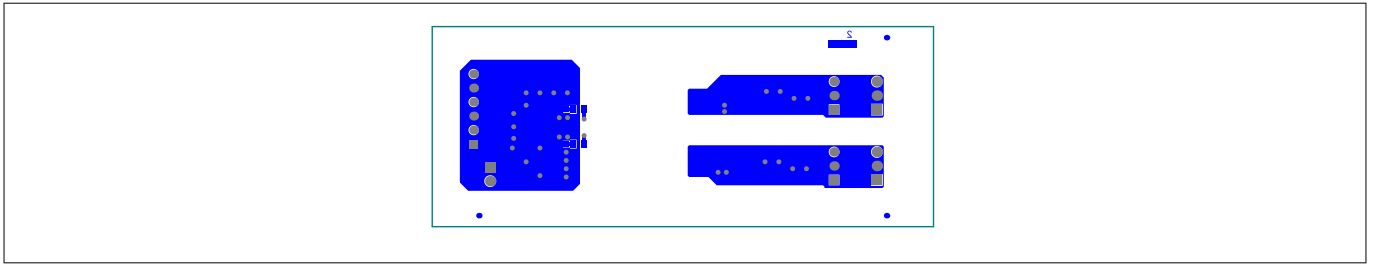

Figure 11 Bottom layer

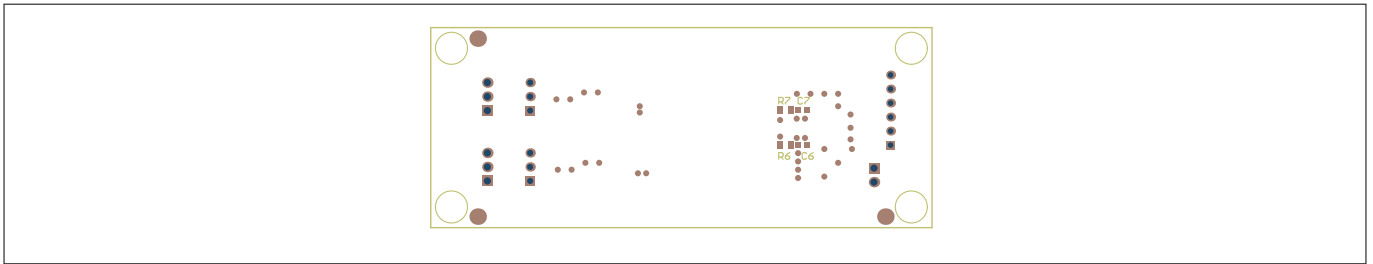

Figure 12 Solder side assembly

3.3 Bill of material

The complete bill of material is available in the download section of Infineon's homepage. Login credentials are required to download this material.

Table 6 BOM of the most important parts of the evaluation board

S. No.	Ref Designator	Description	Manufacturer	Manufacturer P/N	Populated
1	R1	RES SMD 47.5 kΩ 125mW 1% 0805	Vishay	CRCW080547K5FK	Yes
1	R2	RES SMD 1.54 kΩ 125mW 1% 0805	Vishay	CRCW08051K54FK	Yes
1	R3	RES SMD 63.4 kΩ 125mW 1% 0805	Vishay	CRCW080563K4FK	Yes
1	TR1	Transformer, 1mH, Turn Ratio 1.71:1	Würth Elektronik	750319374 r00	Yes
1	U1	Full-bridge transformer driver for IGBT and SiC MOSFET gate driver supply	Infineon	2EP130R	Yes

3.4 Connector details

Table 7 Connector X1 - Input supply (alternate connector)

PIN	Label	Function
X1.1	GND	Primary input ground reference
X1.2	VDD	Input supply voltage for transformer driver 2EP130R

3 System design

Table 8 Connector X2 - Input side signals and supply

PIN	Label	Function
X2.1	GND	Primary input ground reference
X2.2	VDD	Input supply voltage for transformer driver 2EP130R
X2.3	GND	Primary input ground reference
X2.4	BYP	External PWM input pin for bypass operation mode
X2.5	GND	Primary input ground reference
X2.6	RDY	Ready status output pin, open drain

Table 9 Connectors X10 and X11 - Output supply rail 1

PIN	Label	Function
X10.1, X11.1	VCC1	Positive supply voltage output rail 1
X10.2, X11.2	GND1	Ground reference output rail 1
X10.3, X11.3	VEE1	Negative supply voltage output rail 1

Table 10 Connectors X20 and X21 - Output supply rail 2

PIN	Label	Function
X20.1, X21.1	VCC2	Positive supply voltage output rail 2
X20.2, X21.2	GND2	Ground reference output rail 2
X20.3, X21.3	VEE2	Negative supply voltage output rail 2

4 System performance

4 System performance

This section shows measurement results of the EVAL-2EP130R-VD evaluation board on efficiency, switching wave forms, start-up behavior of output voltages, and output voltage ripple.

Efficiency

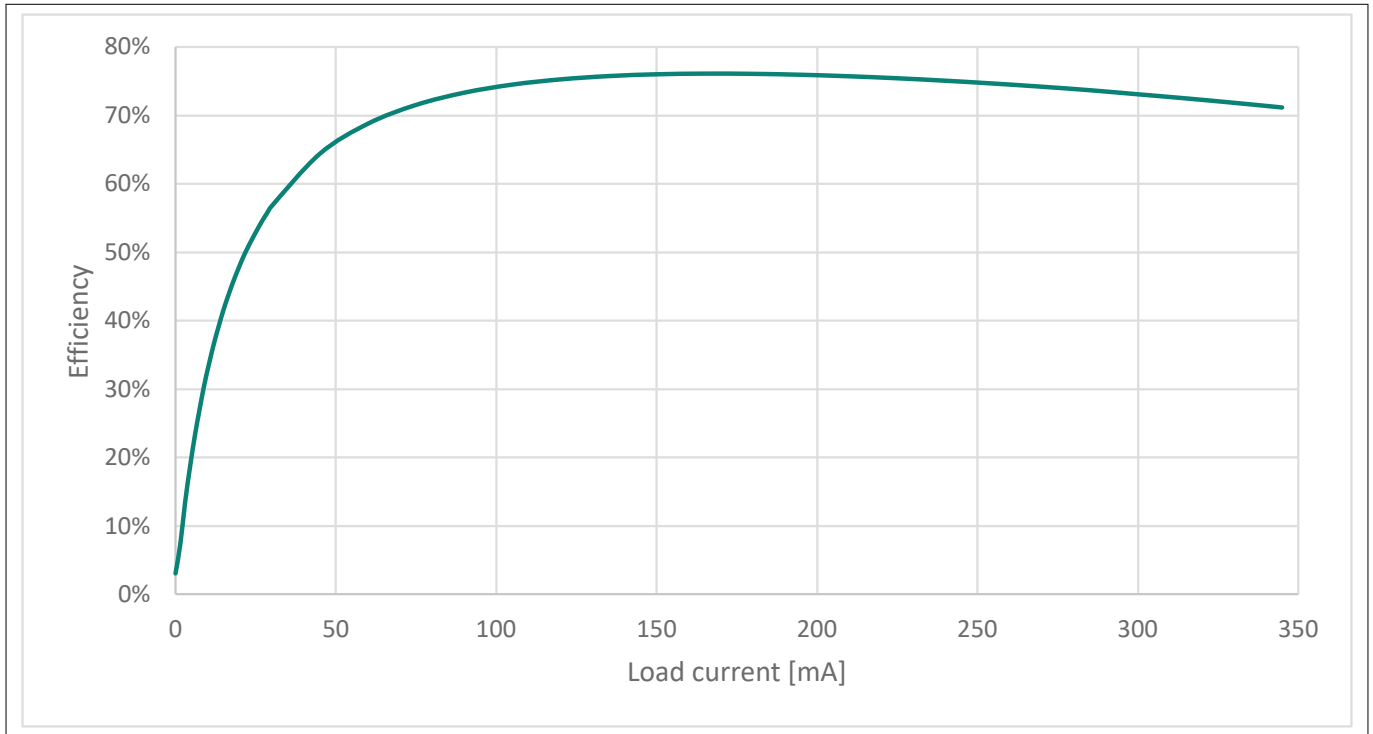

Figure 13 Measuring efficiency using 15 V input voltage and the WE 750319377 transformer

The efficiency measurement records the output voltages and currents and puts them relative to the 2EP input voltage and current during a steady state operation. This measurement was repeated for each individual load current point and drawn on this graph. The efficiency curve varies under different operating conditions such as input voltage, switching frequency, duty cycle and component selection of the transformer. This measurement was performed with the evaluation board EVAL-2EP130R-PR at 15 V, 80 kHz, 12% duty cycle, and using Würth Elektronik's transformer 750319377. The efficiency results are comparable with this evaluation board.

4 System performance

Switching waveform at start-up

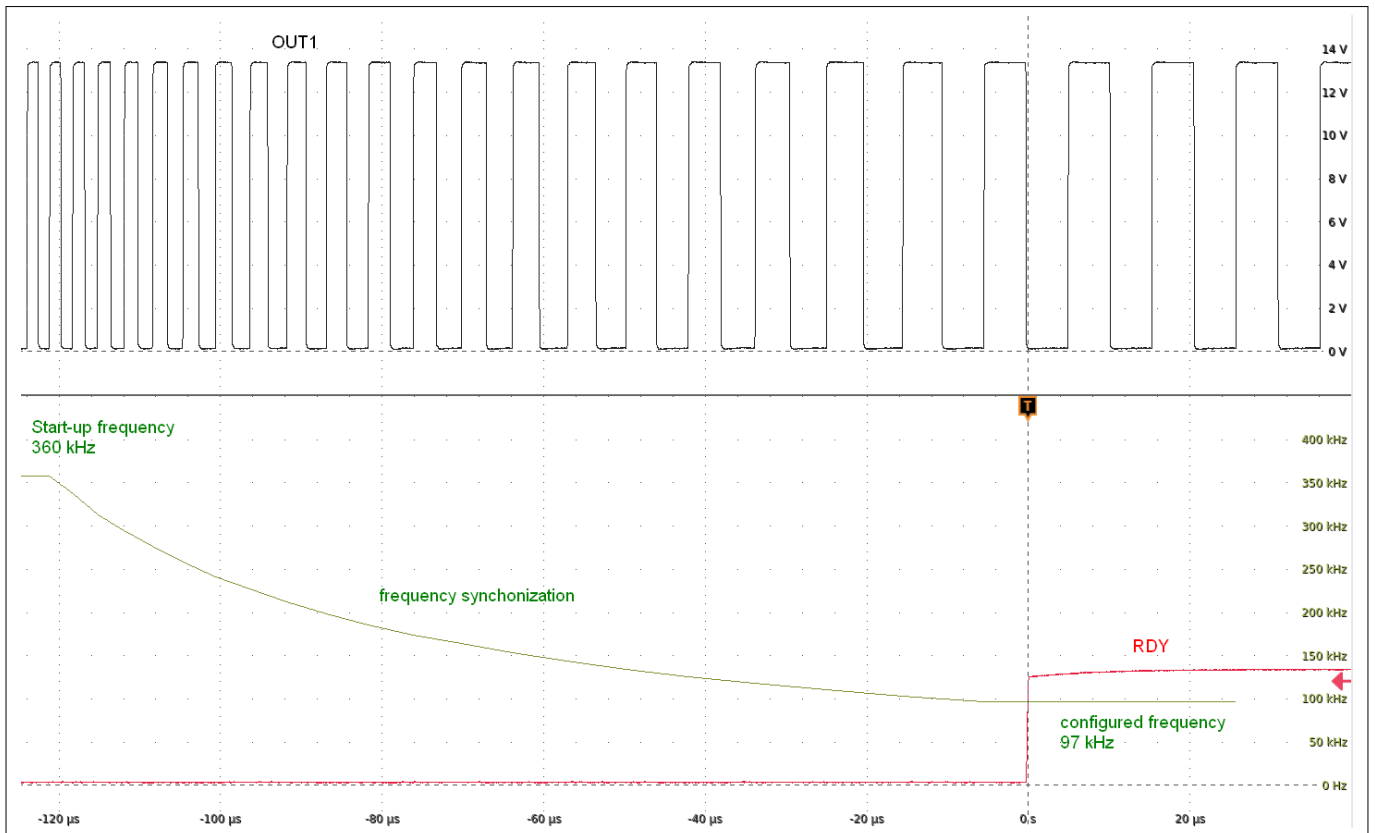

Figure 14 **OUT1 switching waveform**

The upper diagram shows the *OUT1* switching waveform. From left to right, the 2EP1xxR still operates in the start-up peak current mode. On reaching the target duty cycle without triggering the peak-current limits it synchronizes the switching frequency to the configured frequency. On reaching the target frequency, the 2EP1xxR releases the *RDY* pin to indicate the successful start-up.

4 System performance

Start-up behavior of the output voltages

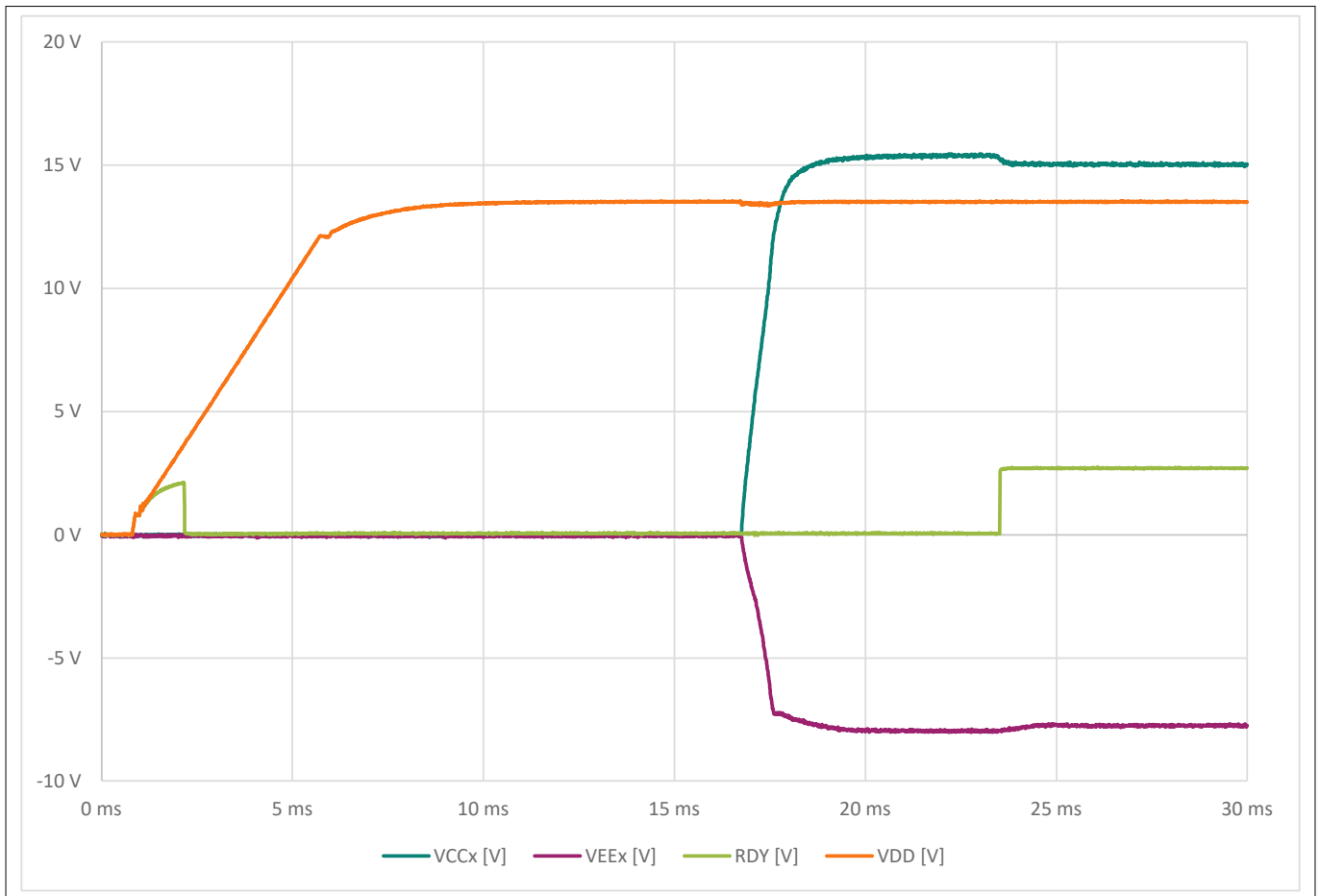

Figure 15 Start-up behavior

The output voltages $VCCX$ and $VEEX$ together with the input voltage ramp-up at VDD and the RDY signal as generated by the evaluation board

The RDY signal briefly follows the input supply voltage, VDD , until the internal under voltage lockout (UVLO) circuit activates and pulls the RDY signal down to GND level. 2EP1xxR releases the RDY signal after the internal start-up phase.

4 System performance

Output voltage ripple

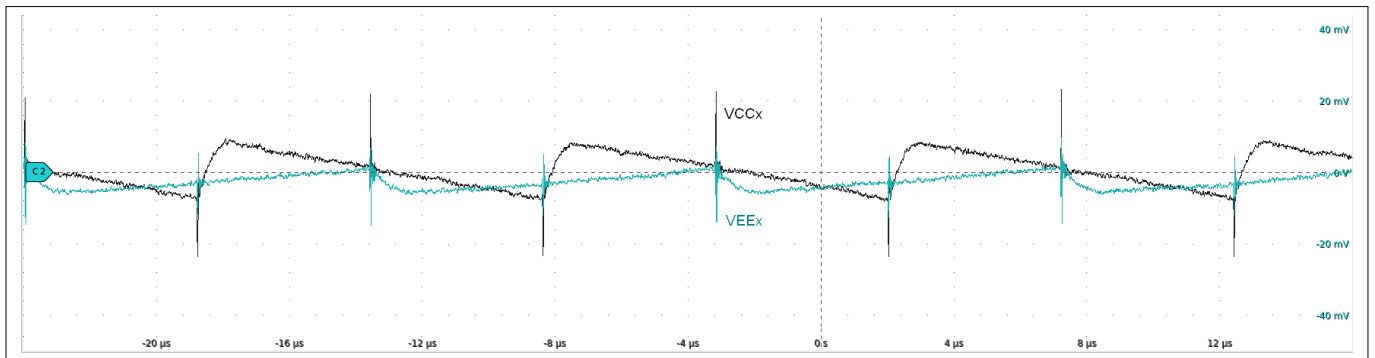

Figure 16 VCCx and VEE output voltage ripple

The output voltage ripple of VCCx has a higher amplitude due to the selected duty cycle. The positive output voltage is double compared to the negative output voltage. Therefore, the effective capacitance for the positive output voltage is reduced due to the capacitor derating. This measurement shows the output ripple for a load current of approximately 30 mA.

5 Additional information

5 Additional information

Table 11 Orderable part numbers

Evaluation board	OPN	Description
EVAL-2EP130R-PR	EVAL2EP130RPRTOBO1	2EP130R board with peak rectification and 3 transformers
EVAL-2EP130R-PR-SiC	EVAL2EP130RPRSICTOBO1	2EP130R board with peak rectification for SiC MOSFETs
EVAL-2EP130R-VD	EVAL2EP130RVDTOBO1	2EP130R board with voltage doubler for IGBTs

Table 12 Compatible gate driver evaluation boards

Evaluation board	OPN	Description
EVAL-1ED3121MX12H	EVAL1ED3121MX12HTOBO1	1ED3121MX12H board - 2300 V, 5.5 A, 5.7 kV (rms) with separate output
EVAL-1ED3122MX12H	EVAL1ED3122MX12HTOBO1	1ED3122MX12H board - 2300 V, 10 A, 5.7 kV (rms) with active Miller clamp
EVAL-1ED3124MX12H	EVAL1ED3124MX12HTOBO1	1ED3124MX12H board - 2300 V, 14 A, 5.7 kV (rms) with separate output
EVAL-1ED3142MU12F-SiC	EVAL1ED3142MU12FSICTOBO1	1ED3142MU12F board - 2300 V, 6.5 A, 3 kV (rms) with separate output
EVAL-1ED3241MC12H	EVAL1ED3241MC12HTOBO1	1ED3241MC12H board - 2300 V, 18 A, 5.7 kV (rms) with two-level slew-rate control
EVAL-1ED3251MC12H	EVAL1ED3251MC12HTOBO1	1ED3251MC12H board - 2300 V, 18 A, 5.7 kV (rms) with slew-rate control and clamp
EVAL-1ED3321MC12N	EVAL1ED3321MC12NTOBO1	1ED3321MC12N board - 2300 V, 8.5 A, 5.7 kV (rms) with DESAT and Soft-off
EVAL-1ED3491MX12M	EVAL1ED3491MX12MTOBO1	1ED3491MX12M board - 2300 V, 9 A, 5.7 kV (rms) with adjustable DESAT and Soft-off
EVAL-1ED3890MX12M	EVAL1ED3890MX12MTOBO1	1ED3890MX12M board - 2300 V, 9 A, 5.7 kV (rms) with I2C configurable behavior

Revision history

Revision history

Document version	Date of release	Description of changes
v1.00	2024-02-26	<ul style="list-style-type: none">initial version
		<ul style="list-style-type: none">

Trademarks

All referenced product or service names and trademarks are the property of their respective owners.

Edition 2024-02-26

Published by

Infineon Technologies AG

81726 Munich, Germany

© 2024 Infineon Technologies AG

All Rights Reserved.

Do you have a question about any aspect of this document?

Email: erratum@infineon.com

Document reference

IFX-pdm1694602232972

For further information on the product, technology, delivery terms and conditions and prices please contact your nearest Infineon Technologies office (www.infineon.com)

Warnings

Due to technical requirements products may contain dangerous substances. For information on the types in question please contact your nearest Infineon Technologies office.

Except as otherwise explicitly approved by Infineon Technologies in a written document signed by authorized representatives of Infineon Technologies, Infineon Technologies' products may not be used in any applications where a failure of the product or any consequences of the use thereof can reasonably be expected to result in personal injury.

X-ON Electronics

Largest Supplier of Electrical and Electronic Components

Click to view similar products for [Power Management IC Development Tools](#) category:

Click to view products by [Infineon](#) manufacturer:

Other Similar products are found below :

[EVB-EP5348UI](#) [BQ25010EVM](#) [ISL80019AEVAL1Z](#) [ISLUSBI2CKIT1Z](#) [ISL8002AEVAL1Z](#) [ISL91108IIA-EVZ](#) [ISL28022EVKIT1Z](#)
[STEVAL-ISA008V1](#) [DRI0043](#) [KITPF8100FRDMEVM](#) [NCP10671B05GEVB](#) [EVB-EN6337QA](#) [SAMPLEBOXILD8150TOBO1](#)
[AP62300WU-EVM](#) [KITA2GTC387MOTORCTRTOBO1](#) [AEK-MOT-TK200G1](#) [EVLONE65W](#) [STEVAL-ILH006V1](#) [STEVAL-IPE008V2](#)
[STEVAL-IPP001V2](#) [STEVAL-ISA013V1](#) [STEVAL-ISA067V1](#) [STEVAL-ISQ002V1](#) [TPS2306EVM-001](#) [TPS2330EVM-185](#)
[TPS40001EVM-001](#) [SECO-HVDCDC1362-15W-GEVB](#) [BTS7030-2EPA](#) [LT8638SJV#WPBF](#) [LTC3308AIV#WTRPBF](#) [TLT807B0EPV](#)
[BTS71033-6ESA](#) [EV13N91A](#) [EASYPIC V8 OVER USB-C](#) [EV55W64A](#) [CLICKER 4 FOR STM32F4](#) [EASYMX PRO V7A FOR STM32](#)
[CLICKER 4 FOR PIC18F](#) [Si8285_86v2-KIT](#) [NCP-NCV51752D2PAK3LGEVB](#) [ISL81807EVAL1Z](#) [EVALM7HVIGBTTPFCINV4TOBO1](#)
[903-0300-000](#) [902-0173-000](#) [903-0301-000](#) [ROA1286023/1](#) [REFSHA35IMD111TSYSTOBO1](#) [150037482](#) [SABMB629](#) [TDINV3000W50B-](#)
[KIT](#)