

700 mA non-isolated high-voltage buck evaluation board using CoolSET™ ICE5BR2280BZ-1

EVAL_5BR2280BZ-1_700mA1

About this document

Scope and purpose

This document describes a non-isolated 15 V, 700 mA high-voltage (HV) buck converter using the latest CoolSET™ 5th Generation Fixed Frequency Plus ICE5BR2280BZ-1 switching controller from Infineon. The document contains power supply specifications, schematics, bill of materials (BOM), PCB layout, and performance data.

This evaluation board is designed to evaluate the performance of CoolSET™ ICE5BR2280BZ-1 switching controller for its ease of use.

Intended audience

This document is intended for SMPS design/application engineers, students, etc., who wish to design low-cost and non-isolated buck converters for applications such as auxiliary power supplies for white goods, smart metering, etc.

CoolSET™

Infineon's CoolSET™ AC-DC integrated power stages in fixed-frequency switching scheme offers increased robustness and outstanding performance. This family offers superior energy efficiency, comprehensive protective features, and reduced system costs and is ideally suited for auxiliary power supply applications in a wide variety of potential applications such as:

- [SMPS](#)
- [Home appliances](#)
- [Server](#)
- [Telecom](#)

Table of contents

About this document	1
Table of contents	2
1 Introduction	3
2 Evaluation board	4
3 Specifications of evaluation board	5
4 Schematic	6
5 Circuit description	7
5.1 Line input.....	7
5.2 Start-up.....	7
5.3 Integrated MOSFET and PWM control	7
5.4 Output stage.....	7
5.5 Feedback control.....	7
5.6 Primary-side peak-current control.....	7
5.7 Frequency reduction	8
5.8 Active burst mode	8
5.9 Protection features	8
6 PCB layout	9
6.1 Top side	9
6.2 Bottom side	9
7 Bill of materials	10
8 Test results	12
8.1 Efficiency.....	12
8.2 Standby power	13
8.3 Line and load regulation	14
8.4 Surge immunity (EN 61000-4-5)	15
8.5 Conducted emissions (EN 55022 class B)	15
8.6 Thermal measurement	16
9 Waveforms and scope plots	17
9.1 Start-up with maximum load.....	17
9.2 Soft-start.....	17
9.3 Drain voltage and Drain current at maximum load	18
9.4 Output ripple voltage at maximum load	18
9.5 ABM operation	19
9.6 Overload protection (extended cycle skip auto-restart)	19
9.7 Output short test.....	20
10 Design example A	21
10.1 Specification of design example A.....	21
10.2 Full-load efficiency	22
References	23
Design support	24
Revision history	25
Disclaimer	26

1 Introduction

This document describes a 15 V, 700 mA evaluation board designed in a buck converter topology using the CoolSET™ 5th Generation Fixed Frequency Plus ICE5BR2280BZ-1 switching controller. The target applications of the ICE5BR2280BZ-1 switching controller are either auxiliary power supplies for white goods, PCs, servers or TVs, or enclosed adapters for games consoles and smart metering, etc. The 800 V CoolMOS™ integrated into this IC greatly simplifies the design and layout of the PCB. The new improved digital frequency reduction and frequency jitter feature offer lower EMI and higher efficiency. The enhanced active burst mode (ABM) power enables flexibility in standby power operation range selection. In addition, numerous adjustable protection functions have been implemented in ICE5BR2280BZ-1 switching controller to protect the system and customize the IC for the chosen application.

700 mA non-isolated high-voltage buck evaluation board using CoolSET™ ICE5BR2280BZ-1

EVAL_5BR2280BZ-1_700mA1

Evaluation board

2 Evaluation board

Typical operating characteristics such as performance curve and scope waveforms are shown at the end of the report.

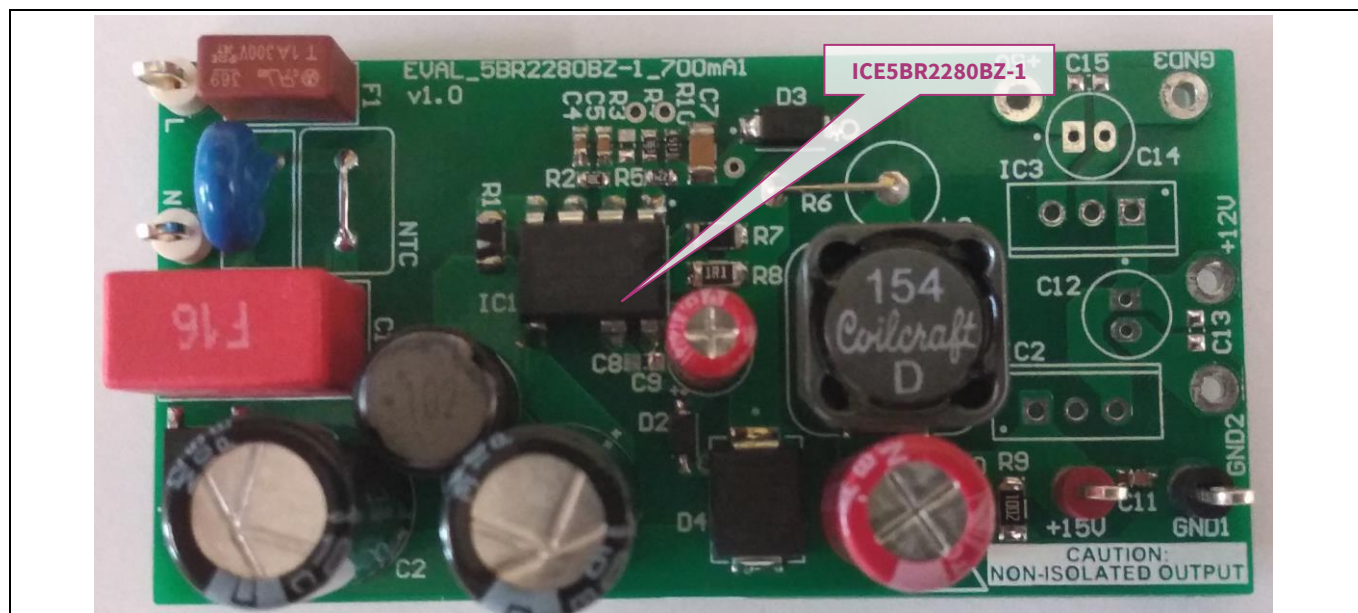

Figure 1 EVAL_5BR2280BZ-1_700mA1

700 mA non-isolated high-voltage buck evaluation board using CoolSET™ ICE5BR2280BZ-1



EVAL_5BR2280BZ-1_700mA1

Specifications of evaluation board

3 Specifications of evaluation board

Table 1 Specifications of EVAL_5BR2280BZ-1_700mA1

Description	Symbol	Min.	Typ.	Max.	Unit	Comments
Input						
Voltage	V_{IN}	85	–	264	V AC	2-wire (no P.E.)
Frequency	f_{LINE}	47	50/60	63	Hz	
Output						
Voltage	V_{OUT}	15			V	–
Current	I_{OUT}	0.7			A	–
Output power	P_{OUT}	10.5			W	–
Output voltage accuracy	–	< ±5%			%	–
Overcurrent protection	–	< 150% of rated current			A	–
Ripple and noise voltage	V_{pk-pk}	< 1% (20 MHz bandwidth)			mV	With 10 µF e-cap and 0.1 µF MLCC
Environmental						
Conducted EMI	–	6			dB	Margin, CISPR 22 Class B
Surge immunity						
Differential mode (DM)		± 1			kV	EN 61000-4-5
Ambient temperature	T_{ambw}	-20	–	50	°C	Free convection, sea level
PCB form factor	–	70 × 35 × 23			mm	L × W × H

Note: The table above represents the minimum acceptable performance of the design; actual measurement results are given in the test results section. This evaluation board is designed to demonstrate the maximum output current only.

700 mA non-isolated high-voltage buck evaluation board using CoolSET™ ICE5BR2280BZ-1

EVAL_5BR2280BZ-1_700mA1

Schematic

4 Schematic

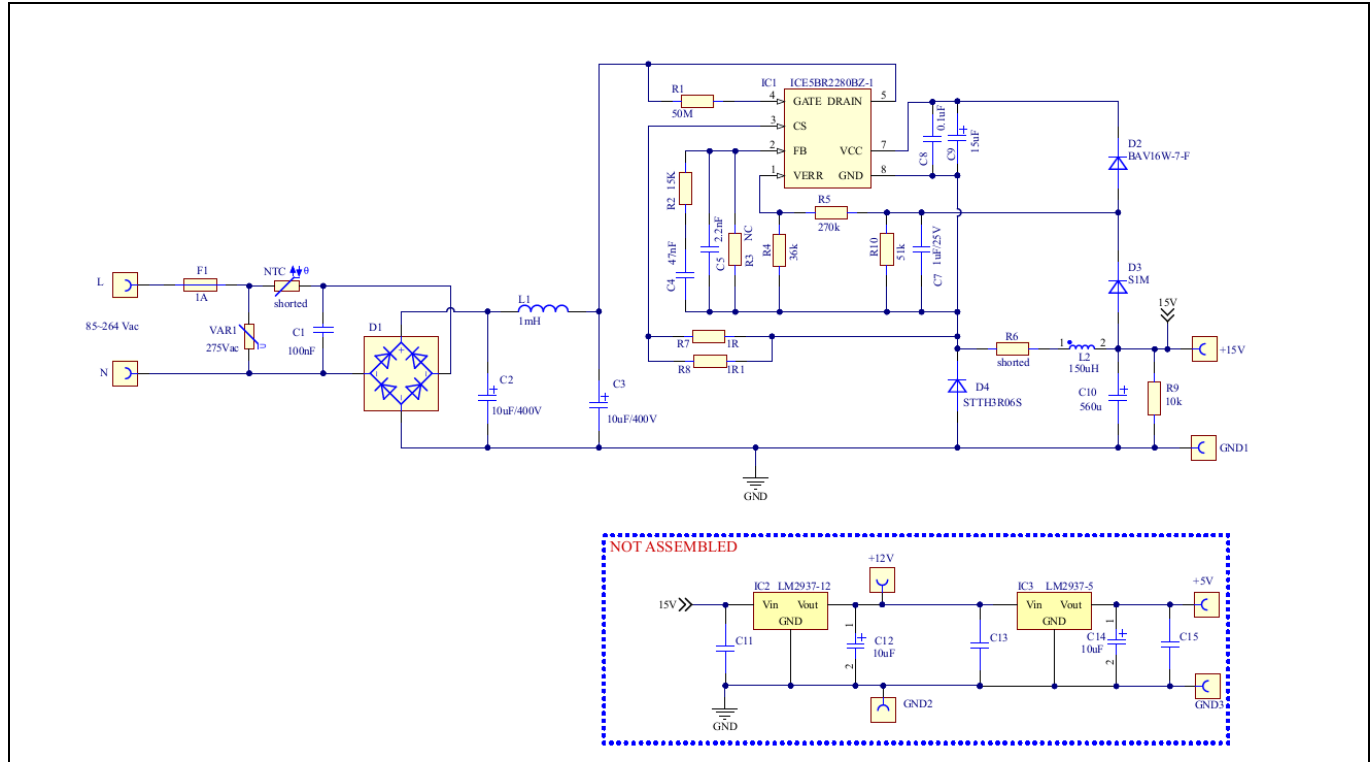

Figure 2 EVAL_5BR2280BZ-1_700mA1

5 Circuit description

5.1 Line input

The AC-line input stage comprises the input fuse (F1), varistor (VAR1), X-capacitor (C1), rectifier diode bridge (D1), capacitors (C2 and C3), and inductor (L1). The X-capacitor (C1) and π -filter (C2, L1, and C3) act as EMI suppressors.

5.2 Start-up

ICE5BR2280BZ-1 uses a cascode structure to fast-charge the V_{CC} capacitor. Pull-up resistor (R1) connected to the GATE pin (pin 4) is used to initiate the start-up phase. When V_{CC} reaches the turn-on voltage threshold 16 V, the IC begins with a soft-start.

The soft-start implemented in ICE5BR2280BZ-1 switching controller is a digital time-based function. The preset soft-start time is 12 ms with four steps. If not limited by other functions, the peak voltage on the CS pin will increase in increments from 0.3 V to 0.8 V. After IC turn-on, the V_{CC} voltage is supplied by output voltage. The V_{CC} short-to-GND protection is implemented during the start-up time.

5.3 Integrated MOSFET and PWM control

ICE5BR2280BZ-1 comprises a power MOSFET and the controller, which simplifies the circuit layout and reduces the cost of PCB manufacture. The controller together with the MOSFET is placed at the high-side of the converter with a floating ground at the cathode of freewheeling diode (D4). An ultra-fast recovery diode (D4) is used to allow the inductor demagnetizing current to flow through it and limit the spike current through the power MOSFET, especially when the buck converter operates in CCM mode. Thus, output voltage is sensed only during freewheeling diode conduction time.

5.4 Output stage

The maximum output voltage ripple is determined by the output capacitance and the equivalent series resistance (ESR) of the output capacitor. Selection of a low-ESR capacitor helps to reduce ripple. The dummy load resistor (R9) helps output voltage regulation at light-load condition.

5.5 Feedback control

ICE5BR2280BZ-1 switching controller integrates a transconductance amplifier for feedback (FB) control. The output is sensed by the voltage divider (R4 and R5) and compared with an internal reference voltage at the VERR pin. An external compensation network (C4, C5, and R2) is recommended on the FB pin to control output voltage.

5.6 Primary-side peak-current control

The MOSFET drain-source current is sensed via external resistors (R7 and R8). ICE5BR2280BZ-1 switching controller is a current mode controller and has a cycle-by-cycle primary current and FB voltage control, which ensures the converter's maximum power is controlled in every switching cycle. To avoid mis-triggering caused by MOSFET switch-on transient voltage spikes, a leading-edge blanking (LEB) time (t_{CS_LEB}) is integrated in the current sensing (CS) path.

5.7 Frequency reduction

Frequency reduction is implemented in ICE5BR2280BZ-1 switching controller to achieve better efficiency at light load. At light load, the reduced switching frequency F_{SW} improves efficiency by reducing the switching losses. When load decreases, V_{FB} and F_{SW} decrease. Typically, F_{SW} at high load is 65 kHz and starts to decrease at $V_{FB} = 1.7$ V. There is no further frequency reduction once it reaches the f_{OSC_MIN} even if the load is further reduced.

5.8 Active burst mode

ABM entry and exit power (two levels) can be selected in ICE5BR2280BZ-1 IC. Details are illustrated in the product datasheet. ABM power level 1 is used in this evaluation board (R3 = open).

5.9 Protection features

ICE5BR2280BZ-1 switching controller provides comprehensive protections to ensure safe system operation. This includes V_{CC} overvoltage (OV) and undervoltage (UV), overload, output OV, overtemperature (controller junction), and V_{CC} short-to-GND. When those faults are found, the system will enter protection mode. Once the fault is removed, the system resumes normal operation.

To protect ICE5BR2280BZ-1 switching controller from excess thermal stress during auto-restart protection, a 15 μ F V_{CC} capacitor (C9) is used to extend the total auto-restart off-time to around 2s, as shown in [Figure 17](#).

700 mA non-isolated high-voltage buck evaluation board using CoolSET™ ICE5BR2280BZ-1

EVAL_5BR2280BZ-1_700mA1

PCB layout

6 PCB layout

6.1 Top side

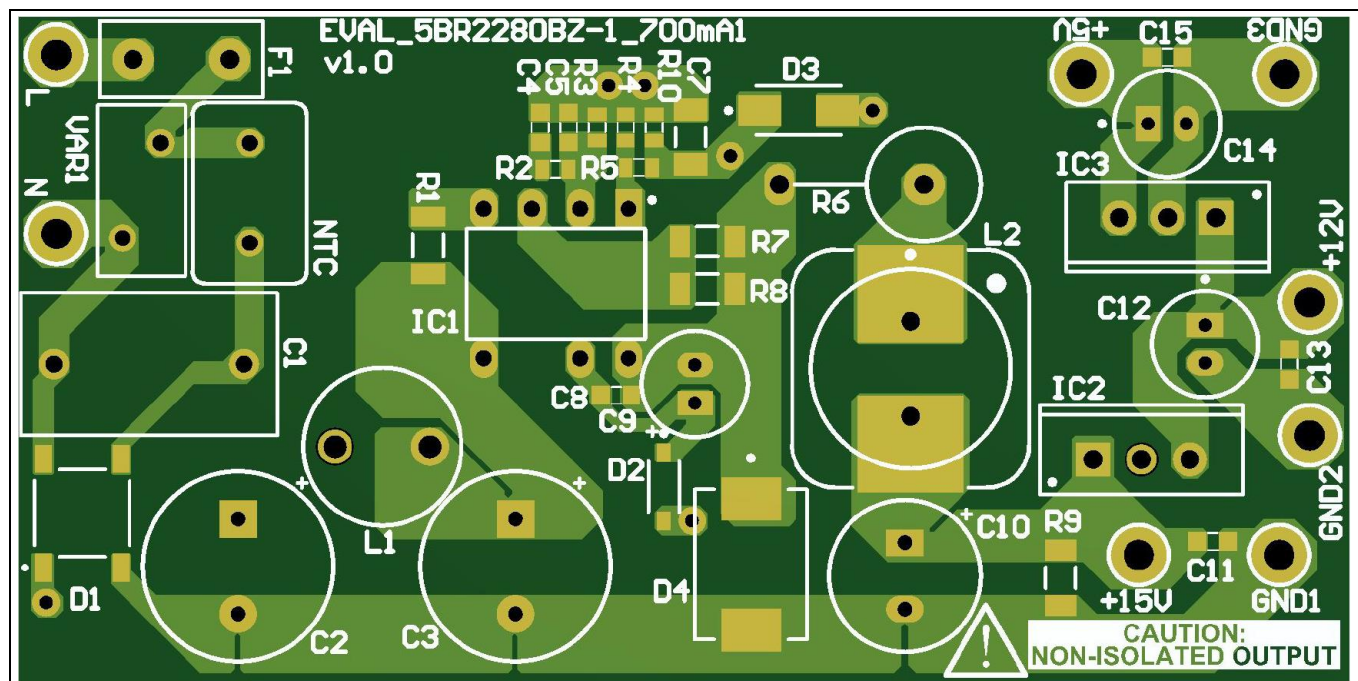

Figure 3 Top-side copper and component legend

6.2 Bottom side

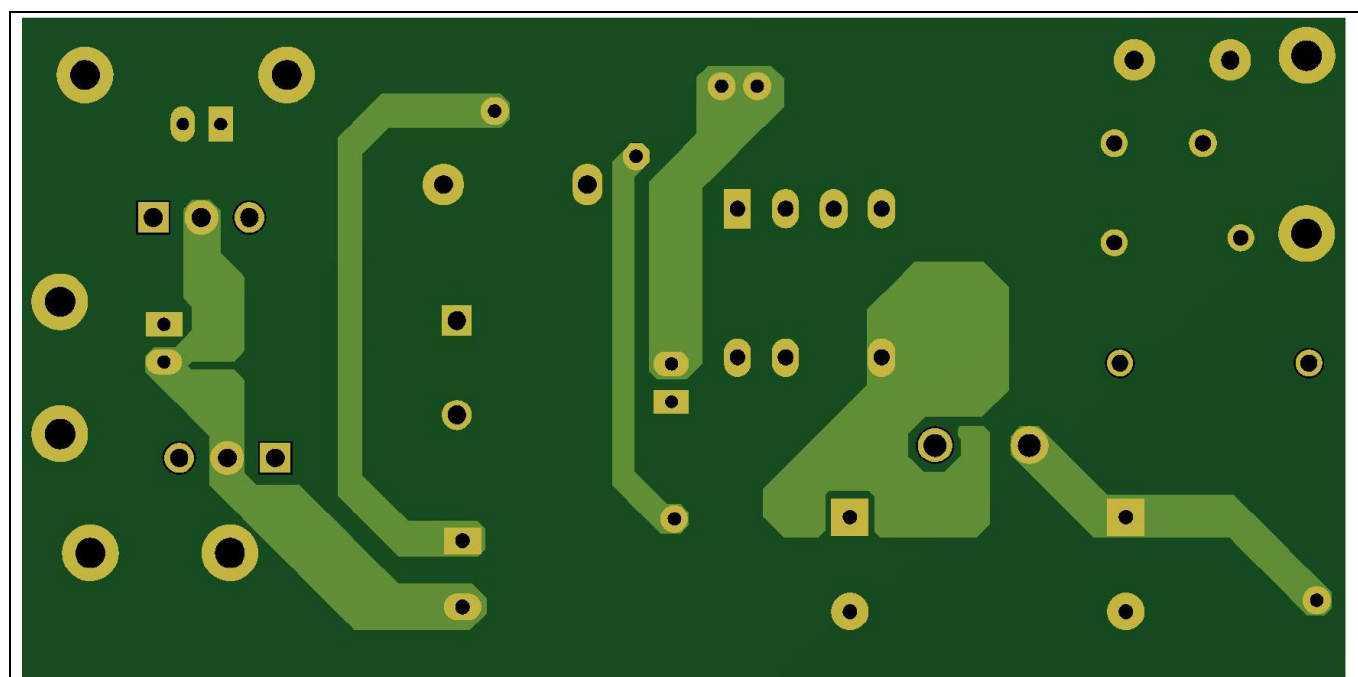

Figure 4 Bottom-side copper

700 mA non-isolated high-voltage buck evaluation board using CoolSET™ ICE5BR2280BZ-1



EVAL_5BR2280BZ-1_700mA1

Bill of materials

7 Bill of materials

Table 2 BOM

No	Designator	Description	Manufacturer	Manufacturer order number	Quantity
1	C1	CAP FILM 0.1UF 10% 310VAC RADIAL	Würth Elektronik	890334023023	1
2	C2, C3	CAP ALUM 10UF 20% 450V RADIAL	Rubycon	450BXC10MEFC10X20	2
3	C4	CAP CER 47nF 25V X7R 0603	-	-	1
4	C5	CAP CER 2.2nF 25V X7R 0603	-	-	1
5	C7	CAP CER 1uF 25V X7R 1206	-	-	1
6	C9	CAP ALUM 15uF 20% 50V RADIAL	Würth Elektronik	8.60161E+11	1
7	C10	CAP ALUM 560UF 20% 25V RADIAL	Würth Elektronik	860160474023	1
8	C11, C13, C15	CAP CER 0.1UF 50V X7R 0603	-	-	3
9	C12, C14	CAP ALUM 10UF 20% 50V RADIAL	Rubycon	50PX10MEFC5X11	2
10	D1	BRIDGE RECT 1PHASE 1KV 1A 4SOPA	Diodes Incorporated	ABS10A-13	1
11	D2	DIODE GEN PURP 100V 150MA SOD123	Diodes Incorporated	BAV16W-7-F	1
12	D3	DIODE GEN PURP 1KV 1A SMA DO-214AC	Vishay	S1M	1
13	D4	Surface Mount Ultrafast Power Rectifier	STMicroelectronics	STTH3R06S	1
14	F1	FUSE BOARD MNT 1A 300VAC RADIAL	-	-	1
15	IC1	CoolSET™ Gen5 Fixed Frequency DIP7	Infineon Technologies	ICE5BR2280BZ-1	1
16	IC2	IC REG LINEAR 12V 1.5A TO220AB	STMicroelectronics	L7812CV	1
17	IC3	IC REG LINEAR 5V 1.5A TO220AB	STMicroelectronics	L7805CV	1
18	L1	FIXED IND 1000UH 0.6A 1.27 OHM	Würth Elektronik	7447452102	1
19	L2	FIXED IND 150UH 2.5A	Coilcraft	MSS1210-154KED	1
20	NTC	ICL 5 OHM 20% 4.2A 9.5MM	TDK	B57235S0509M000	Short

700 mA non-isolated high-voltage buck evaluation board using CoolSET™ ICE5BR2280BZ-1



EVAL_5BR2280BZ-1_700mA1

Bill of materials

No	Designator	Description	Manufacturer	Manufacturer order number	Quantity
21	R1	RES 50 MOhms 300mW 1206	-	CRHA1206AF50M0FKEF	1
22	R2	RES SMD 15K OHM 1% 1/10W 0603	-	-	1
23	R4	RES SMD 36K OHM 1% 1/10W 0603	-	-	1
24	R5	RES SMD 270K OHM 1% 1/10W 0603	-	-	1
25	R6	RES 2 OHM 3W TH	-	MCKNP03UJ020JB00	1
26	R7	RES SMD 1 OHM 1% 1/2W 1206	-	-	1
27	R8	RES SMD 1.1 OHM 1% 1/2W 1206	-	-	1
28	R9	RES SMD 10K OHM 1% 1/4W 1206	-	-	1
29	R10	RES SMD 51K OHM 1% 1/10W 0603	-	-	1
30	VAR1	S07K275E2/275VAC/10%	Epcos	B72207S2271K101	1
31	Line, Neutral	PC Test Point- Multipurpose THT, White	Keystone	5012	2
32	GND1, GND2, GND3	PC Test Point- Multipurpose THT, Black	Keystone	5011	3
33	+5V, +12V, +15V	PC Test Point- Multipurpose THT, Red	Keystone	5010	3

700 mA non-isolated high-voltage buck evaluation board using CoolSET™ ICE5BR2280BZ-1



EVAL_5BR2280BZ-1_700mA1

Test results

8 Test results

8.1 Efficiency

Table 3 Efficiency

Input (V AC/Hz)	Load percentage (%)	P _{IN} (W)	V _{OUT} (V DC)	I _{OUT} (A)	P _{OUT} (W)	Efficiency η (%)	Average η (%)
85 V AC/60 Hz	No load	0.062	16.500	0.000			
	25	3.225	15.175	0.175	2.65	82.25%	82.75%
	50	6.368	15.108	0.350	5.28	82.99%	
	75	9.512	15.074	0.525	7.91	83.12%	
	100	12.742	15.051	0.700	10.53	82.63%	
115 V AC/60 Hz	No load	0.063	16.500	0.000			
	25	3.242	15.188	0.175	2.65	81.89%	82.69%
	50	6.386	15.120	0.350	5.29	82.82%	
	75	9.513	15.087	0.525	7.91	83.18%	
	100	12.704	15.051	0.700	10.53	82.87%	
230 V AC/50 Hz	No load	0.066	16.600	0.000			
	25	3.328	15.178	0.175	2.65	79.72%	81.09%
	50	6.528	15.120	0.350	5.29	81.02%	
	75	9.682	15.095	0.525	7.92	81.77%	
	100	12.865	15.055	0.700	10.53	81.86%	
264 V AC/50 Hz	No load	0.069	16.700	0.000			
	25	3.355	15.170	0.175	2.65	79.04%	80.54%
	50	6.574	15.115	0.350	5.29	80.43%	
	75	9.742	15.088	0.525	7.91	81.23%	
	100	12.931	15.057	0.700	10.53	81.45%	

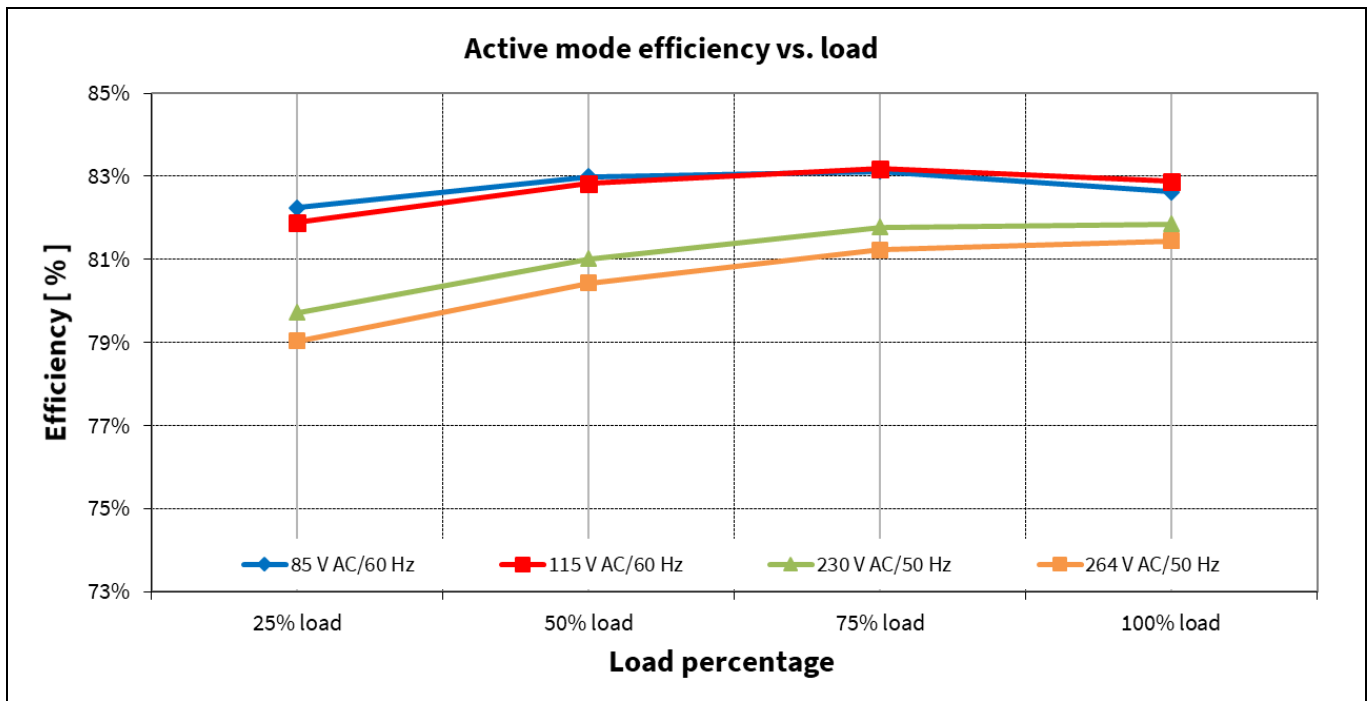

Figure 5 Efficiency vs. AC-line input voltage

8.2 Standby power

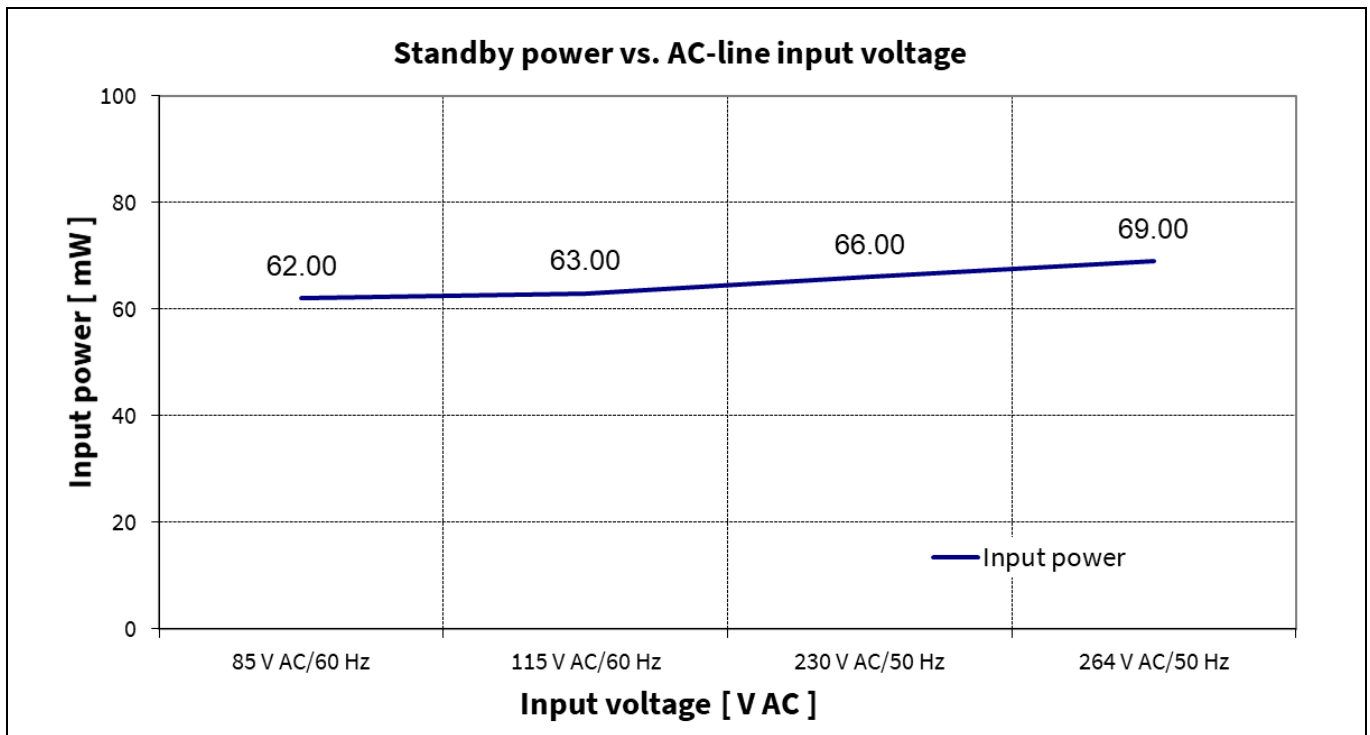

Figure 6 Standby power at 10 kΩ R9 (22 mW) vs. AC-line input voltage. Bleeder resistor R9 prevents output voltage to increase during no load.

8.3 Line and load regulation

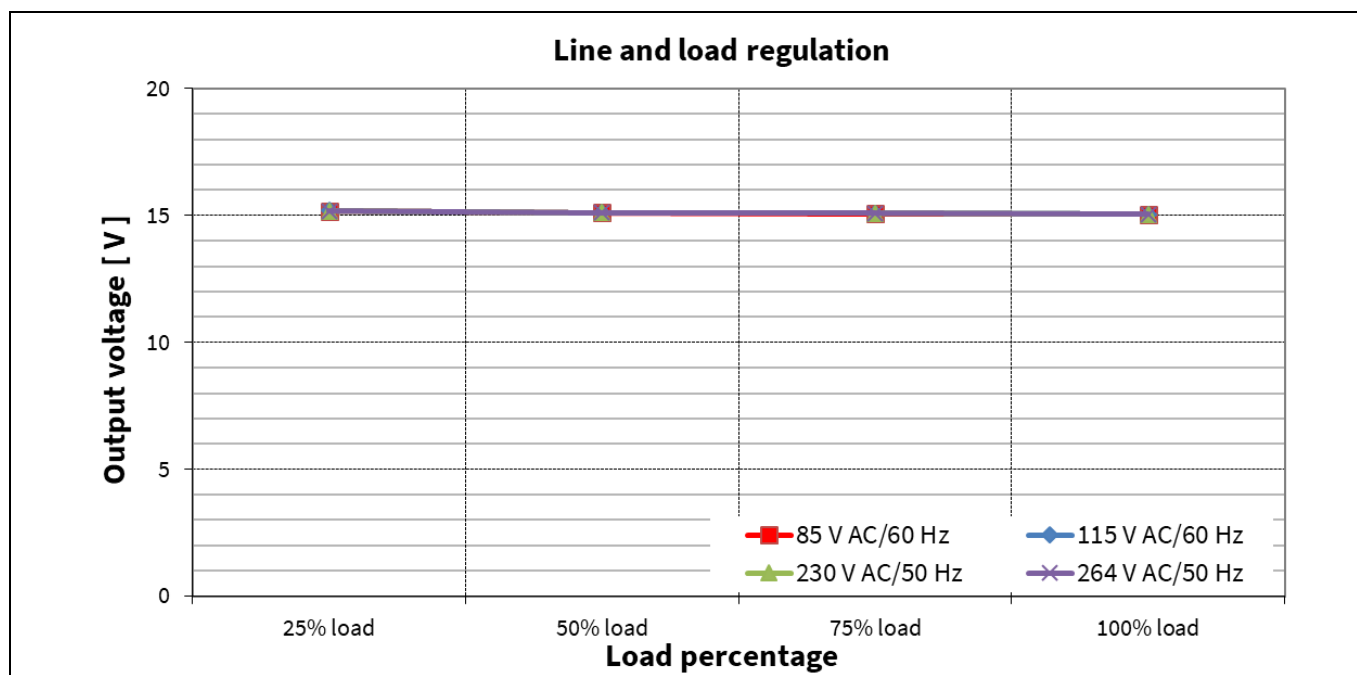

Figure 7 Line and load regulation

700 mA non-isolated high-voltage buck evaluation board using CoolSET™ ICE5BR2280BZ-1

EVAL_5BR2280BZ-1_700mA1

Test results

8.4 Surge immunity (EN 61000-4-5)

EN 61000-4-5 installation class 3 (± 1 kV for line-to-line DM). A test failure is defined as a non-recoverable and/or system auto-restart.

Table 4 Surge immunity test result

Description	Test	Level		Number of strikes				Test result
				0°	90°	180°	270°	
115/230 V AC, 700 mA	DM	+/-1 kV	L → N	3	3	3	3	Pass

8.5 Conducted emissions (EN 55022 class B)

Conducted EMI was measured by Schaffner (SMR4503) and followed the test standard of EN 55022 (CISPR 22) class B. The evaluation board was connected to resistive load (700 mA) with input voltage of 115 V AC and 230 V AC.

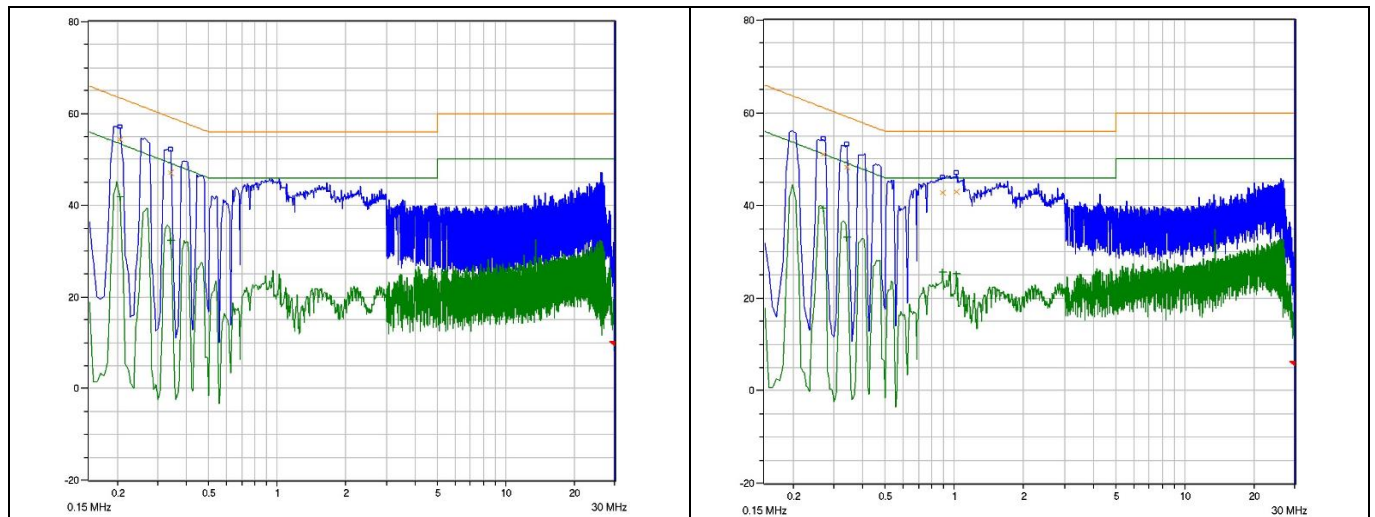

Passed with 6 dB margin for quasi-peak measurement at low-line (115 V AC).

Figure 8 Conducted emissions at 115 V AC with full load

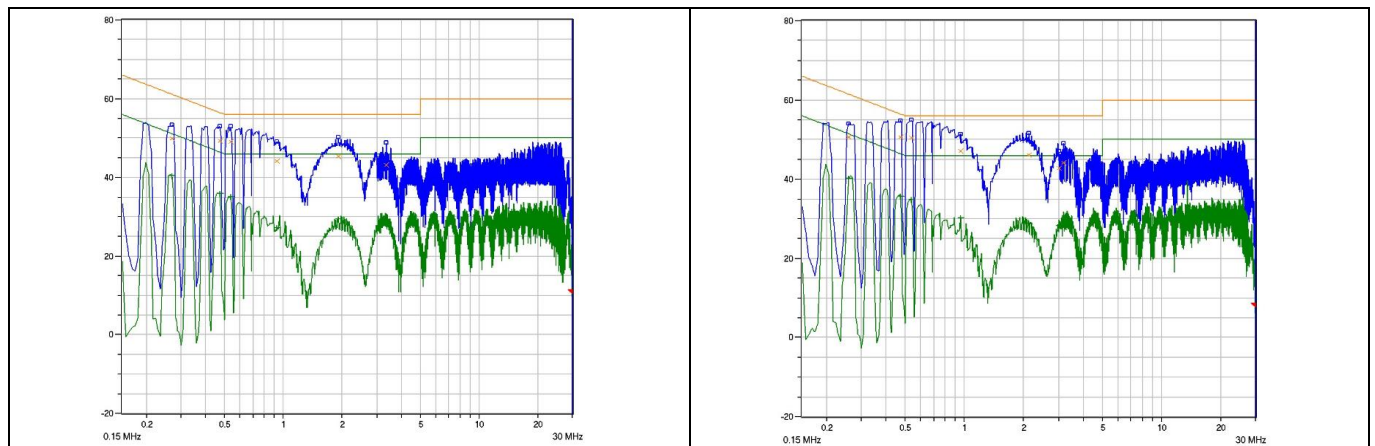

Passed with 6 dB margin for quasi-peak measurement at high-line (230 V AC).

Figure 9 Conducted emissions at 230 V AC with full load

700 mA non-isolated high-voltage buck evaluation board using CoolSET™ ICE5BR2280BZ-1

EVAL_5BR2280BZ-1_700mA1

Test results

8.6 Thermal measurement

The thermal test of the open-frame evaluation board was done using an infrared thermography camera (FLIR-T62101) at an ambient temperature of 25°C. The measurements were taken after one hour running at full load.

Table 5 Hottest temperature of evaluation board

No.	Major component	85 V AC (°C)	264 V AC (°C)
1	D4 (buck diode)	77.5	81.9
2	L2 (buck inductor)	73.2	96.2
3	IC1 (ICE5BR2280BZ-1)	70.5	68.3

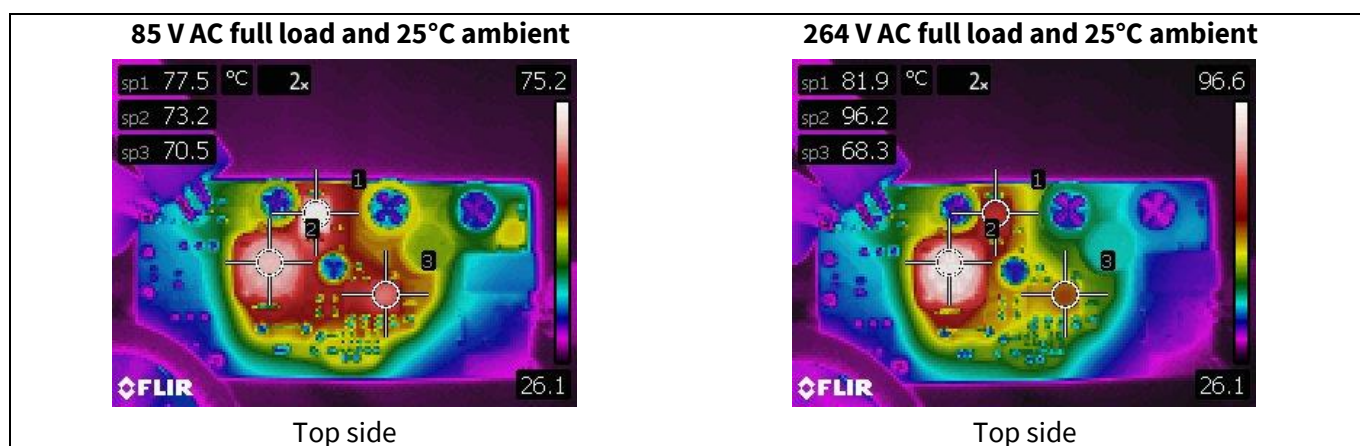

Figure 10 Infrared thermal image of EVAL_5BR2280BZ-1_700mA1

700 mA non-isolated high-voltage buck evaluation board using CoolSET™ ICE5BR2280BZ-1

EVAL_5BR2280BZ-1_700mA1

Waveforms and scope plots

9 Waveforms and scope plots

All waveforms and scope plots were recorded with a Teledyne LeCroy 8054 oscilloscope.

9.1 Start-up with maximum load

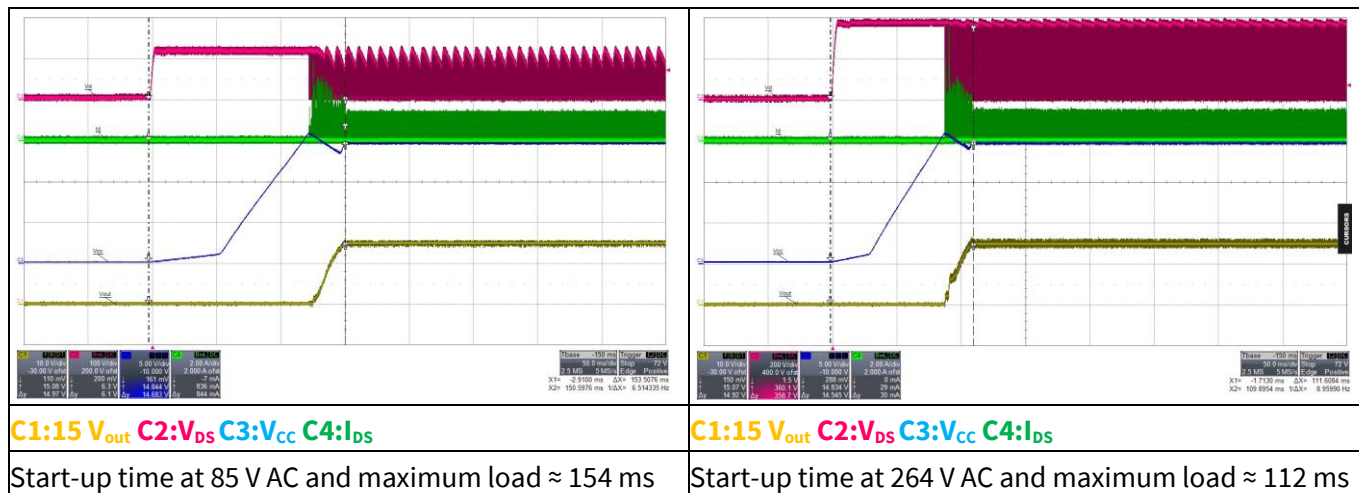

Figure 11 Start-up

9.2 Soft-start

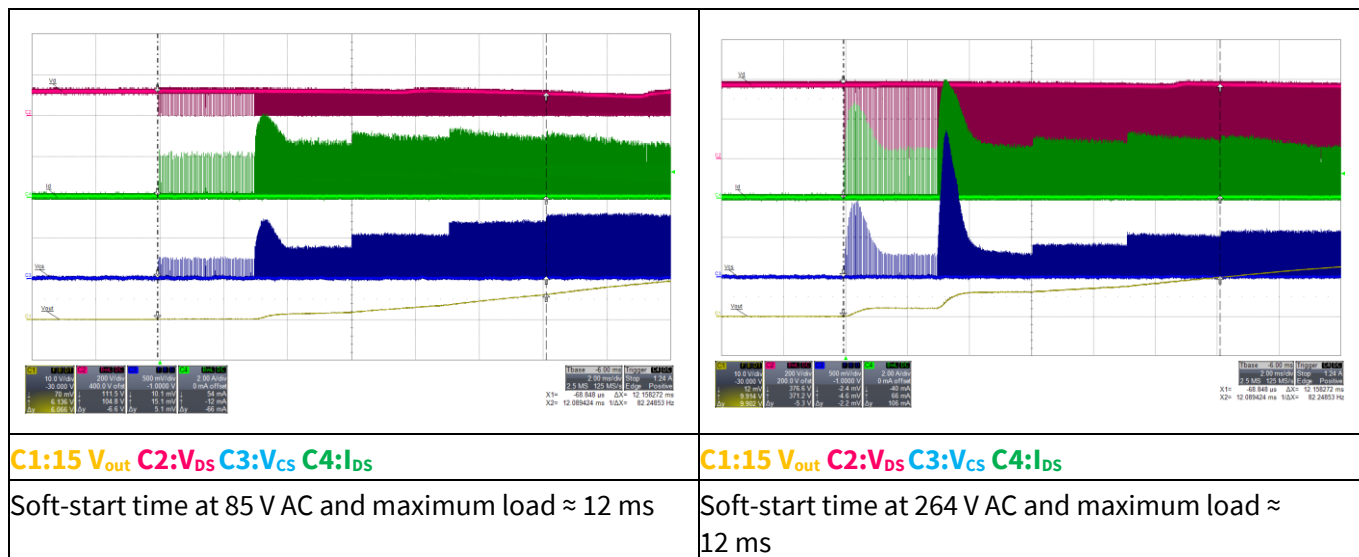

Figure 12 Soft-start

700 mA non-isolated high-voltage buck evaluation board using CoolSET™ ICE5BR2280BZ-1

EVAL_5BR2280BZ-1_700mA1

Waveforms and scope plots

9.3 Drain voltage and Drain current at maximum load

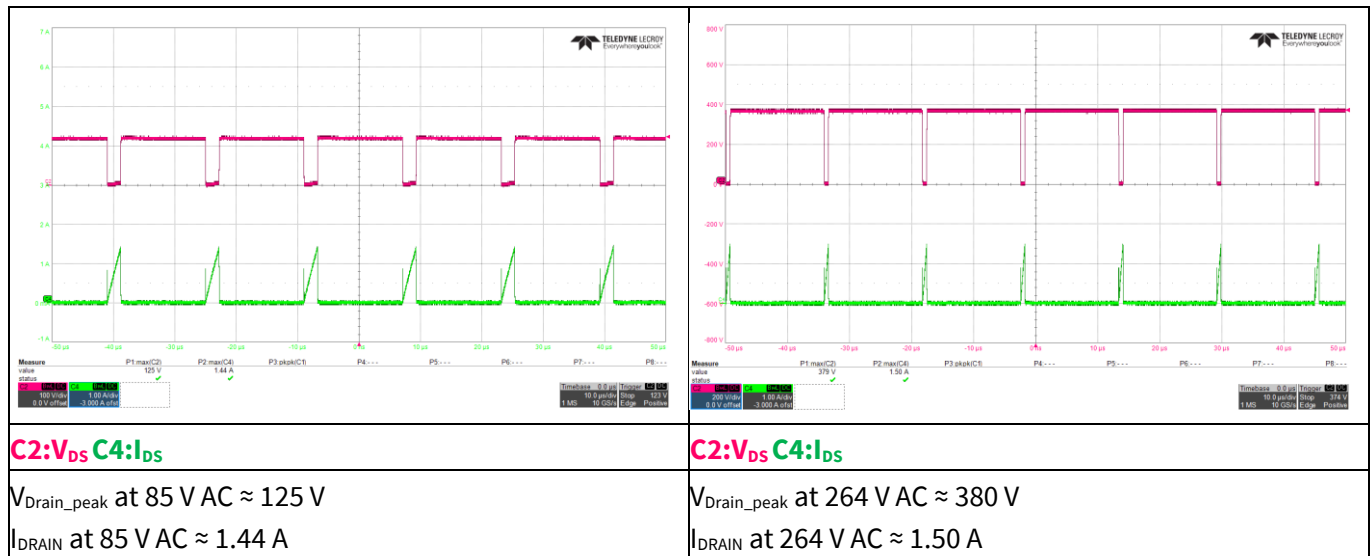

Figure 13 Drain and CS voltage at maximum load

9.4 Output ripple voltage at maximum load

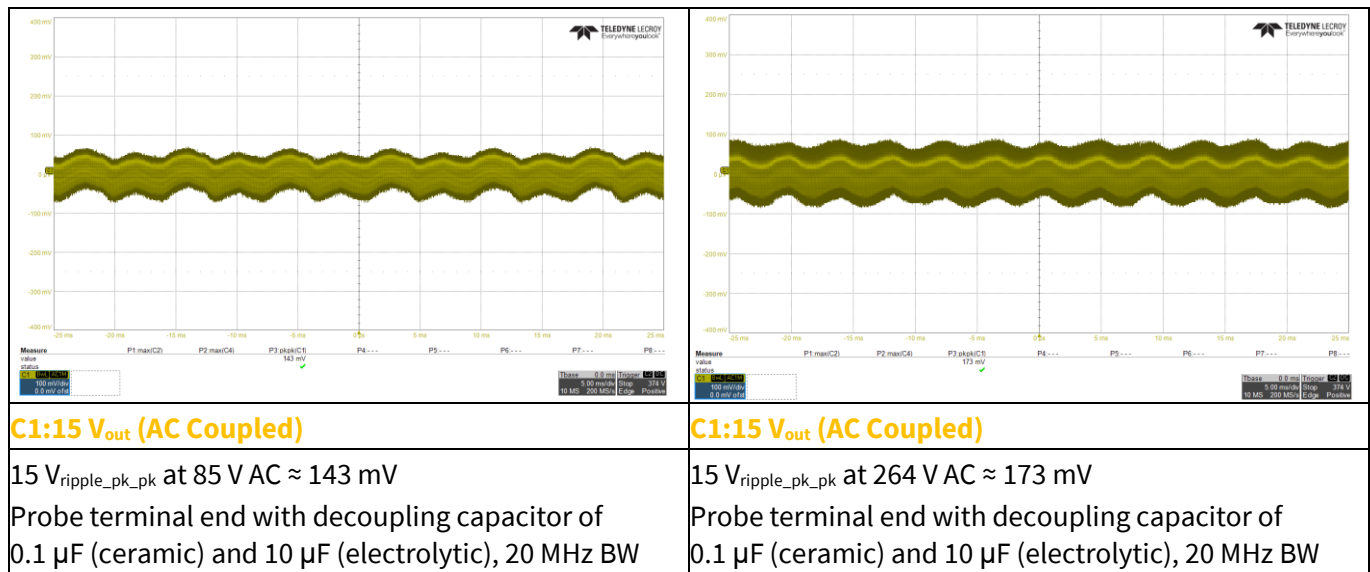

Figure 14 Output ripple voltage at maximum load

700 mA non-isolated high-voltage buck evaluation board using CoolSET™ ICE5BR2280BZ-1

EVAL_5BR2280BZ-1_700mA1

Waveforms and scope plots

9.5 ABM operation

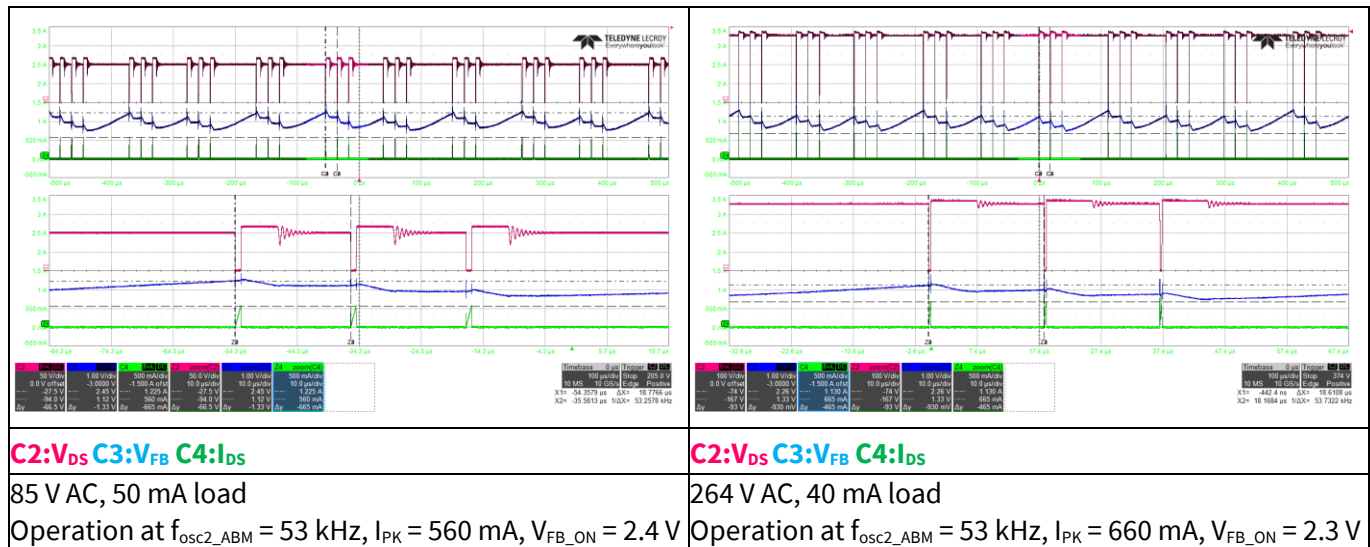
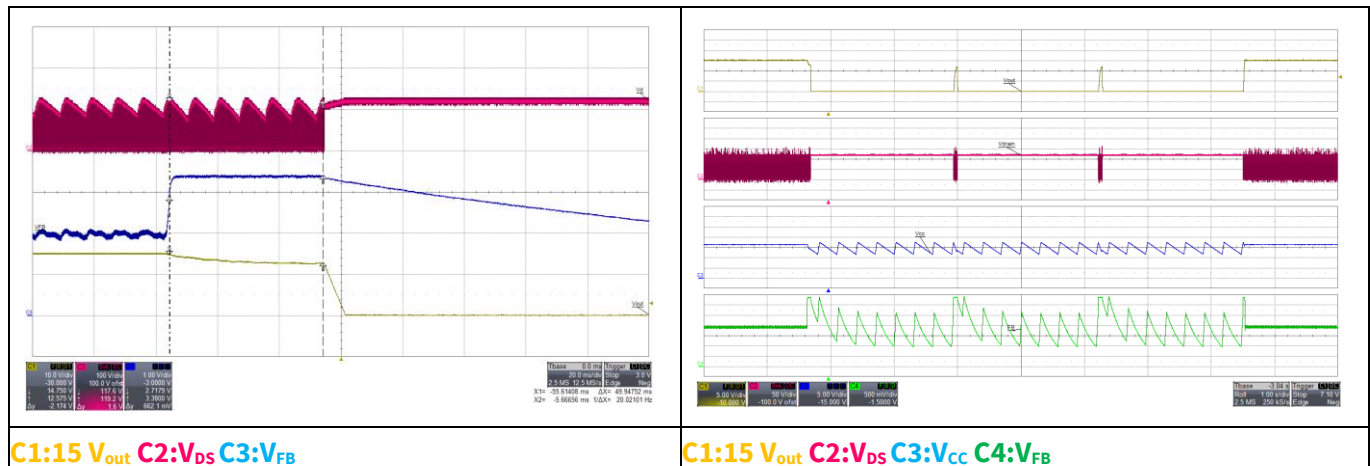

Figure 15 ABM operation

9.6 Overload protection (extended cycle skip auto-restart)



Condition to enter overload protection: V_{FB} more than 2.73 V and lasts for ~54 ms blanking time.
 (15 V output load change from full load to overload with input 85 V AC or 264 V AC)

Figure 16 Overload protection

700 mA non-isolated high-voltage buck evaluation board using CoolSET™ ICE5BR2280BZ-1

EVAL_5BR2280BZ-1_700mA1

Waveforms and scope plots

9.7 Output short test

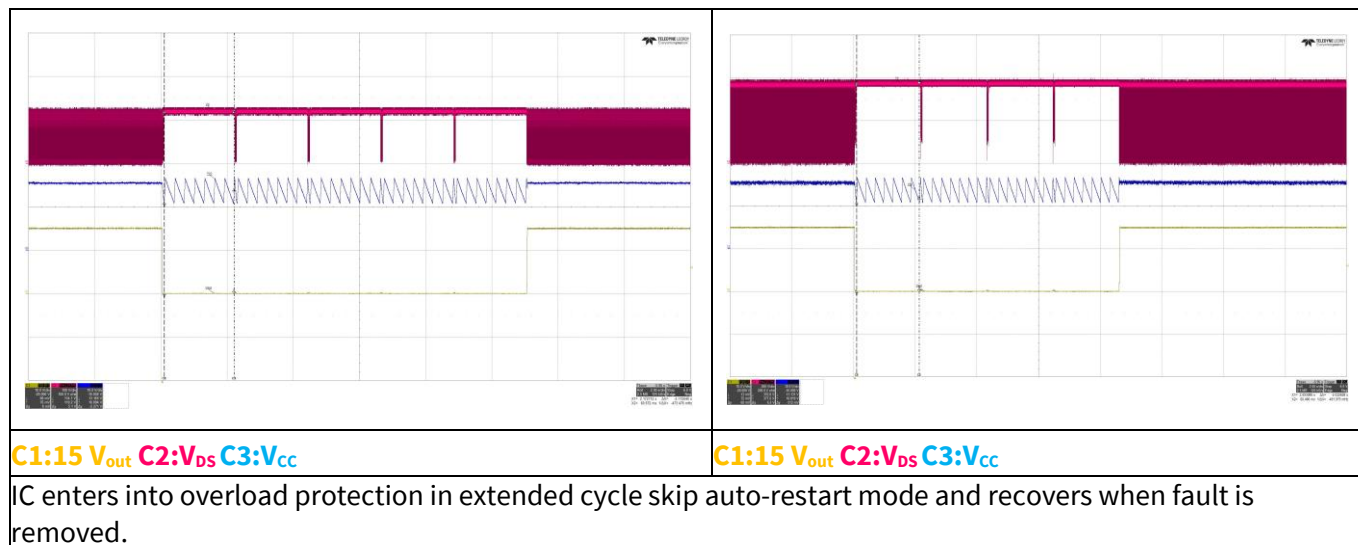

Figure 17 Output short test

10 Design example A

In this evaluation board, there is a component placeholder for two low dropout (LDO) regulators connected in series as shown in Figure 18. The 12 V output regulated by IC2 can supply up to 350 mA and the 5 V output regulated by IC3 can supply up to 200 mA.

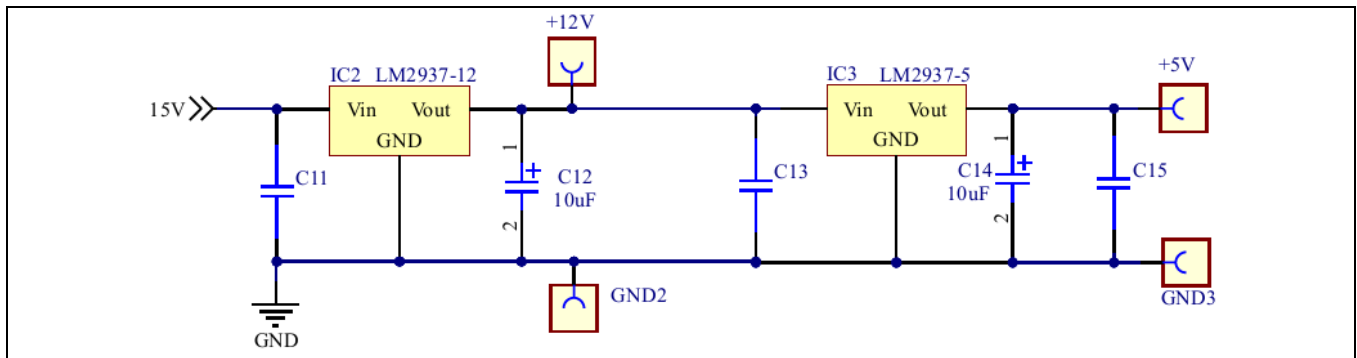

Figure 18 Additional circuit for design example A

Note: Components in the additional circuit shown in Figure 18 are not mounted on the evaluation board.

10.1 Specification of design example A

Since 12 V output and 5 V output are derived from the main output 15 V, the total output current should not exceed maximum capacity of the main output current. See Table 6 for the specification of this design.

Table 6 Specification of design example A

Description	Symbol	Value	Comments
Output voltage 1	V_{O1}	15 V	Main output
Max. output current 1	I_{O1}	0.15 A	–
Output voltage 2 (via LDO)	V_{O2}	12 V	Derived from 15 V output
Max. output current 2	I_{O2}	0.35 A	–
Output voltage 3 (via LDO)	V_{O3}	5 V	Derived from 12 V output
Max. output current 3	I_{O3}	0.2 A	–

700 mA non-isolated high-voltage buck evaluation board using CoolSET™ ICE5BR2280BZ-1



EVAL_5BR2280BZ-1_700mA1

Design example A

10.2 Full-load efficiency

Additional power loss caused by LDO circuits will reduce overall efficiency. LDOs are mounted on the heatsink.

Table 7 Full-load efficiency – example A

Input (V AC/Hz)	P _{IN} (W)	V _{O1} (V DC)	I _{O1} (A)	V _{O2} (V DC)	I _{O2} (A)	V _{O3} (V DC)	I _{O3} (A)	P _{OUT} (W)	Efficiency η (%)
85 V AC/60 Hz	12.974	15.10	0.15	11.793	0.35	4.982	0.2	7.389	56.95%
115 V AC/60 Hz	12.894	15.12	0.15	11.793	0.35	4.982	0.2	7.392	57.33%
230 V AC/50 Hz	13.060	15.13	0.15	11.793	0.35	4.982	0.2	7.393	56.61%
264 V AC/50 Hz	13.100	15.14	0.15	11.793	0.35	4.982	0.2	7.394	56.44%

700 mA non-isolated high-voltage buck evaluation board using CoolSET™ ICE5BR2280BZ-1



EVAL_5BR2280BZ-1_700mA1

References

References

- [1] Infineon Technologies AG: *ICE5xRxxxxBZx-1 datasheet*; [Available online](#)
- [2] Infineon Technologies AG: *CoolSET™ 5th Generation Fixed Frequency Plus buck design guide*; [Available online](#)
- [3] Infineon Technologies AG: *CoolSET™ 5th Generation Fixed Frequency Plus calculation tool for buck*; [Available online](#)

700 mA non-isolated high-voltage buck evaluation board using CoolSET™ ICE5BR2280BZ-1



EVAL_5BR2280BZ-1_700mA1

Design support

Design support

Developer community

For a wider discussion with peers from industry to trade ideas regarding Infineon products, we welcome you to actively participate on the [Infineon Developer Community](#).

Technical support

Have technical queries? Consult experts from Infineon to get a fast turn-around by request on the [Technical Support](#) page or a [local sales representative](#).

700 mA non-isolated high-voltage buck evaluation board using CoolSET™ ICE5BR2280BZ-1



EVAL_5BR2280BZ-1_700mA1

Revision history

Revision history

Document version	Date of release	Description of changes
V 1.0	2024-08-23	Initial release

Trademarks

All referenced product or service names and trademarks are the property of their respective owners.

Edition 2024-08-23

Published by

Infineon Technologies AG

81726 Munich, Germany

**© 2024 Infineon Technologies AG.
All Rights Reserved.**

Do you have a question about this document?

Email: erratum@infineon.com

Document reference

AN074527

Important notice

The information contained in this application note is given as a hint for the implementation of the product only and shall in no event be regarded as a description or warranty of a certain functionality, condition or quality of the product. Before implementation of the product, the recipient of this application note must verify any function and other technical information given herein in the real application. Infineon Technologies hereby disclaims any and all warranties and liabilities of any kind (including without limitation warranties of non-infringement of intellectual property rights of any third party) with respect to any and all information given in this application note.

The data contained in this document is exclusively intended for technically trained staff. It is the responsibility of customer's technical departments to evaluate the suitability of the product for the intended application and the completeness of the product information given in this document with respect to such application.

Please note that this product is not qualified according to the AEC Q100 or AEC Q101 documents of the Automotive Electronics Council.

Warnings

Due to technical requirements products may contain dangerous substances. For information on the types in question please contact your nearest Infineon Technologies office.

Except as otherwise explicitly approved by Infineon Technologies in a written document signed by authorized representatives of Infineon Technologies, Infineon Technologies' products may not be used in any applications where a failure of the product or any consequences of the use thereof can reasonably be expected to result in personal injury.

X-ON Electronics

Largest Supplier of Electrical and Electronic Components

Click to view similar products for [Power Management IC Development Tools](#) category:

Click to view products by [Infineon](#) manufacturer:

Other Similar products are found below :

[EVB-EP5348UI](#) [BQ25010EVM](#) [ISL80019AEVAL1Z](#) [ISLUSBI2CKIT1Z](#) [ISL8002AEVAL1Z](#) [ISL91108IIA-EVZ](#) [ISL28022EVKIT1Z](#)
[STEVAL-ISA008V1](#) [DRI0043](#) [KITPF8100FRDMEVM](#) [NCP10671B05GEVB](#) [EVB-EN6337QA](#) [SAMPLEBOXILD8150TOBO1](#)
[AP62300WU-EVM](#) [KITA2GTC387MOTORCTRTOBO1](#) [AEK-MOT-TK200G1](#) [EVLONE65W](#) [STEVAL-ILH006V1](#) [STEVAL-IPE008V2](#)
[STEVAL-IPP001V2](#) [STEVAL-ISA013V1](#) [STEVAL-ISA067V1](#) [STEVAL-ISQ002V1](#) [TPS2306EVM-001](#) [TPS2330EVM-185](#)
[TPS40001EVM-001](#) [SECO-HVDCDC1362-15W-GEVB](#) [BTS7030-2EPA](#) [LT8638SJV#WPBF](#) [LTC3308AIV#WTRPBF](#) [TLT807B0EPV](#)
[BTS71033-6ESA](#) [EV13N91A](#) [EASYPIC V8 OVER USB-C](#) [EV55W64A](#) [CLICKER 4 FOR STM32F4](#) [EASYMX PRO V7A FOR STM32](#)
[CLICKER 4 FOR PIC18F](#) [Si8285_86v2-KIT](#) [NCP-NCV51752D2PAK3LGEVB](#) [ISL81807EVAL1Z](#) [EVALM7HVIGBTTPFCINV4TOBO1](#)
[903-0300-000](#) [902-0173-000](#) [903-0301-000](#) [ROA1286023/1](#) [REFSHA35IMD111TSYSTOBO1](#) [150037482](#) [SABMB629](#) [TDINV3000W50B-](#)
[KIT](#)