

Eval-iSSI20R02HCS user guide

Board description

iSSI20R02H

Infineon's coreless-transformer advanced solid-state isolator (Infineon SSI)

About this document

This user guide describes the functionalities and key features of Infineon's coreless-transformer advanced solid-state isolator.

Scope and purpose

The Infineon SSI solid-state isolator evaluation board EVAL-iSSI20R02HCS features the coreless-transformer advanced solid-state isolator, iSSI20R02H. This user guide covers the design revision 1.0 of this evaluation board.

iSSI20R02H is certified as per UL 1577 and reinforced isolation (IEC 60747-17, planned).

Intended audience

- Engineers who want to learn how to use Infineon's SSI advanced solid-state isolator iSSI20R02H
- Experienced design engineers who design circuits with photovoltaic isolators (PVI), IGBTs, and MOSFETs
- Design engineers who develop solid-state relays

Evaluation board

The evaluation board EVAL-iSSI20R02HCS is designed based on environmental conditions described in this document. It has been tested as described in this document, but not qualified regarding manufacturing, lifetime, or over the full range of ambient operating conditions. The boards provided by Infineon are not subject to full production tests.

Evaluation boards are not subject to the same procedures as regular products regarding returned material analysis (RMA), process change notification (PCN), and product discontinuation (PD). Evaluation boards are intended to be used under laboratory conditions and by trained specialists only.

Note: The printed circuit board (PCB) and auxiliary circuits are NOT optimized for final customer design.

Important notice

“Evaluation Boards and Reference Boards” shall mean products embedded on a printed circuit board (PCB) for demonstration and/or evaluation purposes, which include, without limitation, demonstration, reference and evaluation boards, kits and design (collectively referred to as “Reference Board”).

Environmental conditions have been considered in the design of the Evaluation Boards and Reference Boards provided by Infineon Technologies. The design of the Evaluation Boards and Reference Boards has been tested by Infineon Technologies only as described in this document. The design is not qualified in terms of safety requirements, manufacturing and operation over the entire operating temperature range or lifetime.

The Evaluation Boards and Reference Boards provided by Infineon Technologies are subject to functional testing only under typical load conditions. Evaluation Boards and Reference Boards are not subject to the same procedures as regular products regarding returned material analysis (RMA), process change notification (PCN) and product discontinuation (PD).

Evaluation Boards and Reference Boards are not commercialized products, and are solely intended for evaluation and testing purposes. In particular, they shall not be used for reliability testing or production. The Evaluation Boards and Reference Boards may therefore not comply with CE or similar standards (including but not limited to the EMC Directive 2004/EC/108 and the EMC Act) and may not fulfill other requirements of the country in which they are operated by the customer. The customer shall ensure that all Evaluation Boards and Reference Boards will be handled in a way which is compliant with the relevant requirements and standards of the country in which they are operated.

The Evaluation Boards and Reference Boards as well as the information provided in this document are addressed only to qualified and skilled technical staff, for laboratory usage, and shall be used and managed according to the terms and conditions set forth in this document and in other related documentation supplied with the respective Evaluation Board or Reference Board.

It is the responsibility of the customer’s technical departments to evaluate the suitability of the Evaluation Boards and Reference Boards for the intended application, and to evaluate the completeness and correctness of the information provided in this document with respect to such application.

The customer is obliged to ensure that the use of the Evaluation Boards and Reference Boards does not cause any harm to persons or third party property.

The Evaluation Boards and Reference Boards and any information in this document is provided "as is" and Infineon Technologies disclaims any warranties, express or implied, including but not limited to warranties of non-infringement of third party rights and implied warranties of fitness for any purpose, or for merchantability.

Infineon Technologies shall not be responsible for any damages resulting from the use of the Evaluation Boards and Reference Boards and/or from any information provided in this document. The customer is obliged to defend, indemnify and hold Infineon Technologies harmless from and against any claims or damages arising out of or resulting from any use thereof.

Infineon Technologies reserves the right to modify this document and/or any information provided herein at any time without further notice.

Board description

Safety precautions

Safety precautions

Note: Please note the following warnings regarding the hazards associated with development systems

Table 1 Safety precautions







	<p>Warning: The DC link potential of this board is up to 1000 VDC. When measuring voltage waveforms by oscilloscope, high voltage differential probes must be used. Failure to do so may result in personal injury or death.</p>
	<p>Warning: The evaluation or reference board is connected to the grid input during testing. Hence, high-voltage differential probes must be used when measuring voltage waveforms by oscilloscope. Failure to do so may result in personal injury or death. Darkened display LEDs are not an indication that capacitors have discharged to safe voltage levels.</p>
	<p>Caution: The heat sink and device surfaces of the evaluation or reference board may become hot during testing. Hence, necessary precautions are required while handling the board. Failure to comply may cause injury.</p>
	<p>Caution: Only personnel familiar with the drive, power electronics and associated machinery should plan, install, commission and subsequently service the system. Failure to comply may result in personal injury and/or equipment damage.</p>
	<p>Caution: The evaluation or reference board contains parts and assemblies sensitive to electrostatic discharge (ESD). Electrostatic control precautions are required when installing, testing, servicing or repairing the assembly. Component damage may result if ESD control procedures are not followed. If you are not familiar with electrostatic control procedures, refer to the applicable ESD protection handbooks and guidelines.</p>
	<p>Caution: An evaluation board that is incorrectly applied or installed can lead to component damage or reduction in product lifetime. Wiring or application errors such as undersizing the load, supplying an incorrect or inadequate AC supply, or excessive ambient temperatures may result in system malfunction.</p>
	<p>Caution: The evaluation or reference board is shipped with packing materials that need to be removed prior to installation. Failure to remove all packing materials that are unnecessary for system installation may result in overheating or abnormal operating conditions.</p>



Table of contents

About this document	1
Important notice	2
Safety precautions	3
Table of contents	4
1 Overview and key features	5
2 Absolute maximum ratings, operating conditions, and supply voltages	6
3 Getting started with EVAL-iSSI20R02HCS	7
3.1 Overcurrent protection	7
3.2 Over-temperature protection	8
3.3 Connectors and pin assignment.....	8
3.4 Board options.....	9
4 Schematic diagram	10
5 Layout	11
6 Bill of materials	12
Revision history	13

1 Overview and key features

EVAL-iSSI20R02HCS is intended for evaluating the product features of Infineon's SSI solid-state isolator, iSSI20R02H, in an application circuit. The key features of the board and the iSSI20R02H are as follows:

- Evaluation board with iSSI20R02H and two OptiMOS™ ISC015N06NM5LF MOSFETs in an AC switch configuration
- Ultra-fast overcurrent detection that is triggered at the typical peak current of 20 A
- Over-temperature protection with PTC resistor (optional)
- Fast turn-on
- Fast turn-off after overcurrent and over-temperature protection
- Dynamic Miller clamping

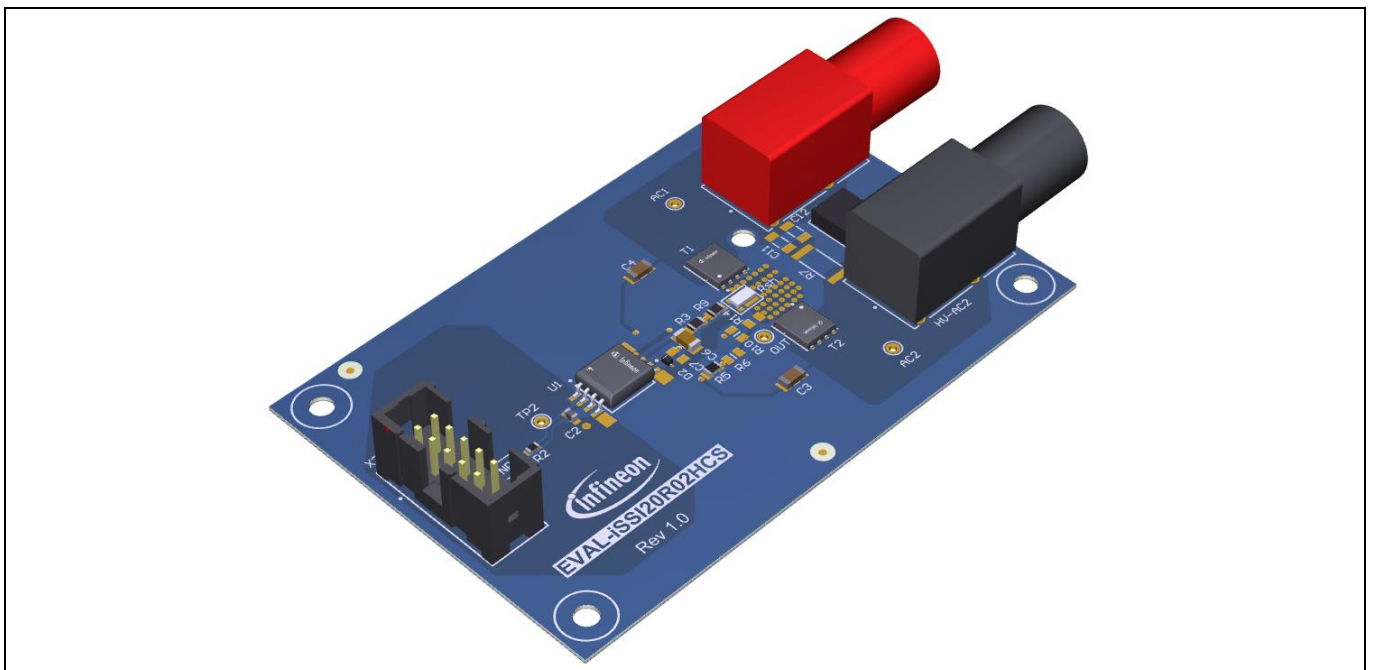

Figure 1 The EVAL-iSSI20R02HCS evaluation board

This board is best suited for testing the switching performance of Infineon SSI and OptiMOS™ with a resistive load as described in Chapter 3. It requires additional considerations about thermal and power balance for continuous operation.

The control interface can be connected to a pulse generator, a microcontroller, or other digital circuits with appropriate driving capability of at least 25 mA.

2 Absolute maximum ratings, operating conditions, and supply voltages

Some components on the evaluation boards as well as the Infineon SSI solid-state isolator have defined operating conditions and maximum ratings to avoid damage to individual parts and the overall evaluation board.

Table 2 Absolute maximum ratings

Pin name / parameter	Connector / symbol	Min	Max	Unit	Note
<i>INP</i>	<i>X2.5, X2.6</i>	-10	3.6	V	Input, Infineon SSI solid-state isolator voltage supply
<i>HV-AC1</i> <i>HV-AC2</i>	<i>HV-AC1</i> <i>HV-AC2</i>	-60	60	V	Input, high-voltage power supply. For 42 V and above, special high-voltage lab environment is strongly recommended
<i>RMS current</i>	<i>HV-AC1/2</i>	-	7	A	
<i>DC current</i>	<i>HV-AC1/2</i>	-	10	A	
<i>AC1 peak current</i> <i>AC2 peak current</i>	<i>HV-AC1</i> <i>HV-AC2</i>	-	20	A	Phase peak current for overcurrent protection test ($t_{\text{pulse}} < 20\mu\text{s}$)
<i>Switching frequency</i>	f_{sw}	-	1	Hz	Maximum switching frequency for continuous operation. Power dissipation required for power transistor and Infineon SSI solid-state isolator has been carefully considered
<i>Ambient temperature</i>	T_a	-	30	°C	

The printed circuit board (PCB) assembly is optimized for a *INP* voltage supply of 3.3 V. Higher supply voltages may require adjustments to the current limiting resistor, R1.

Table 3 Operating conditions and supply voltages

Pin name / parameter	Min.	Typ.	Max.	Unit	Note
<i>INP</i>	2.5	3.3	3.5	V	Input voltage supply
<i>HV-AC1</i>	-40	-	40	V	Input, high-voltage power supply, referenced to <i>HV-AC2</i> . For 42 V and above, special high-voltage lab environment is strongly recommended
<i>Inductive load</i>	-	-	15	μH	
<i>Ambient temperature</i>	-	25	30	°C	

3 Getting started with EVAL-iSSI20R02HCS

Follow the steps given in this chapter to set up and power up the board, and to perform initial evaluations.

Prerequisites

- Have a low-voltage supply ready for the input supply voltage, INP , with a current capability of at least 25 mA for INP . For repetitive switching operation, a suitable function generator can be used, too.
- Have a power supply, V_{HV} , in series with a suitable load, Z_{Load} , ready to connect $HV-AC1$ and $HV-AC2$

To adapt the circuit to application requirements, resistor or capacitor values can be changed to optimize performance.

Steps to power up the board

1. Connect the supply voltage, INP , to connector $X2.5$ with +3.3 V and the ground, GND , to connector $X2.7$.
2. Connect the power supply, V_{HV} , to connector $HV-AC1$.
3. Connect the ground of power supply, V_{HV} , to one end of the load, Z_{Load} , and the other end to connector $HV-AC2$.
4. The board is now ready to evaluate switching.

Steps to safely power down the board

5. Turn off the power supply, V_{HV} .
6. Discharge the DC-link capacitor (if available) and check the DC-link voltage with, e.g., a digital multimeter or an oscilloscope (for DC operation).
7. Turn off the low-voltage supply.

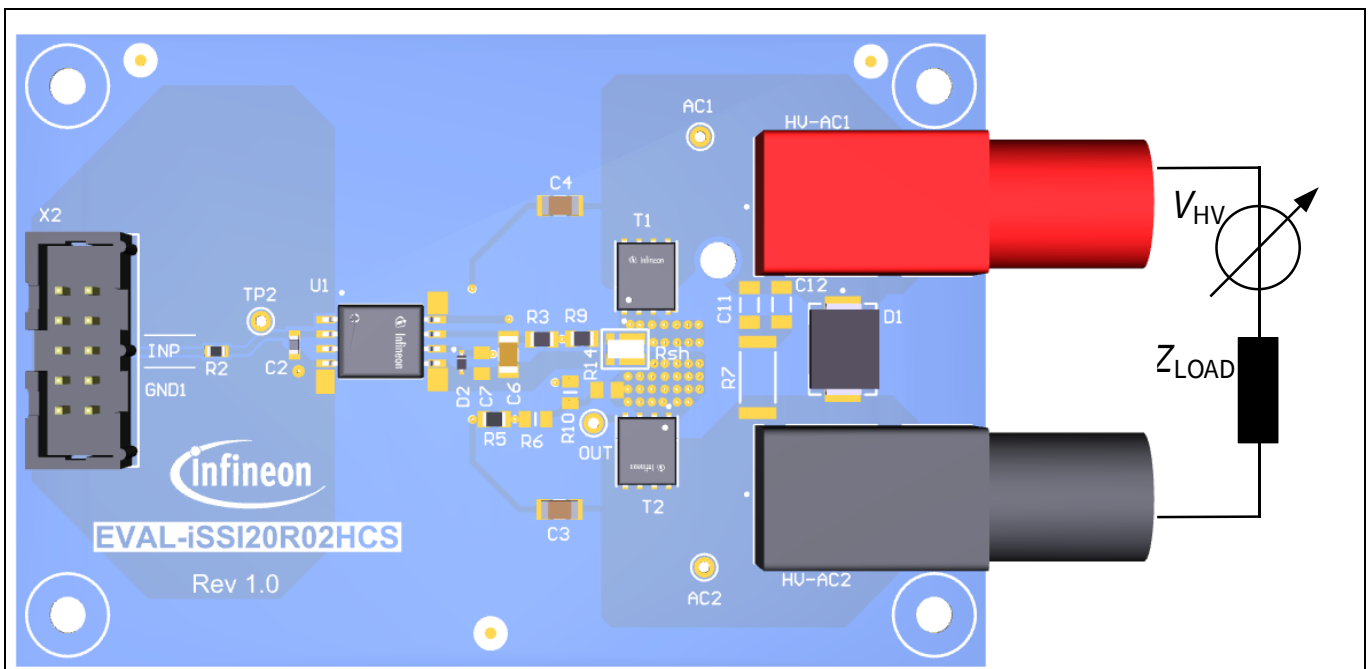

Figure 2 Connection of load, Z_{Load} , for tests

3.1 Overcurrent protection

The detection circuit monitors the voltage across shunt resistor, R_{sh} . This signal passes a noise RC filter, consisting of $R3$ and $C6$. The integrated comparator of the Infineon SSI compares it to a fixed threshold voltage

$|V_{CS,th}|$ at terminal CS of iSSI20R02H. The maximum peak current can be adapted to application requirements by changing the shunt resistor, R_{sh} , using the following equation:

$$R_{sh} = \frac{V_{CS,th}}{I_{pk,max}}$$

Once triggered, the protection reacts quickly and is able to turn off, for example, OptiMOS™ ISC015N06NM5LF in a very short time. Thus, it is able to support AC-15 or other system tests as per IEC 60947-5-1 guidelines under appropriate operating conditions.

The triggering of overcurrent protection leads to the latched turn-off of the power switch with a sinking current, $I_{off,fast,sat}$. To return to normal operation, applying 0 V to *INP* is required.

3.2 Over-temperature protection

The over-temperature feature is not given by default. iSSI20R02H provides a constant bias current, $I_{TS,bias}$, biasing a PTC resistor. The constant current generates a voltage at the PTC that is connected to terminal TS, and the terminal voltage is compared to the threshold voltage $V_{TS,th}$. The integrated comparator includes a noise filter of duration $t_{TS,filter}$ for safely detecting the sensor signal. This noise filter is complemented by an external RC filter (R6, C7).

Once triggered, the protection reacts quickly and is able to turn off, for example, OptiMOS™ ISC015N06NM5LF in a very short time. The triggering of the over-temperature protection leads to the latched turn-off of the power switch with a sinking current of $I_{off,fast,sat}$. To return to normal operation, applying 0 V to *INP* is required.

The triggering of the over-temperature protection can be forced by externally heating of the temperature sensor, as well.

3.3 Connectors and pin assignment

Table 4 Connectors and pin assignment

Connector	Pin	Marking/ function	Note
X2	1, 2, 3, 4 5, 6 7, 8, 9, 10	<i>VSUP</i> <i>INP</i> <i>GND1</i>	Not in use Infineon SSI solid-state isolator input and supply signal Infineon SSI solid-state isolator reference
HV-AC1	1	<i>HV-AC1</i>	High-voltage power supply
HV-AC2	1	<i>HV-AC2</i>	High-voltage power supply

3.4 Board options

The evaluation board offers functional options implemented by parts that are not populated. These options are:

- Realization of a snubber circuit (C11, C12, R7)
- Implement an over-temperature protection using PTC resistor R14. This option requires the following actions:
 - o short shunt resistor Rsh
 - o depopulate resistor R9
 - o populate 0 Ω resistor R10,
 - o populate PTC resistor R14

4 Schematic diagram

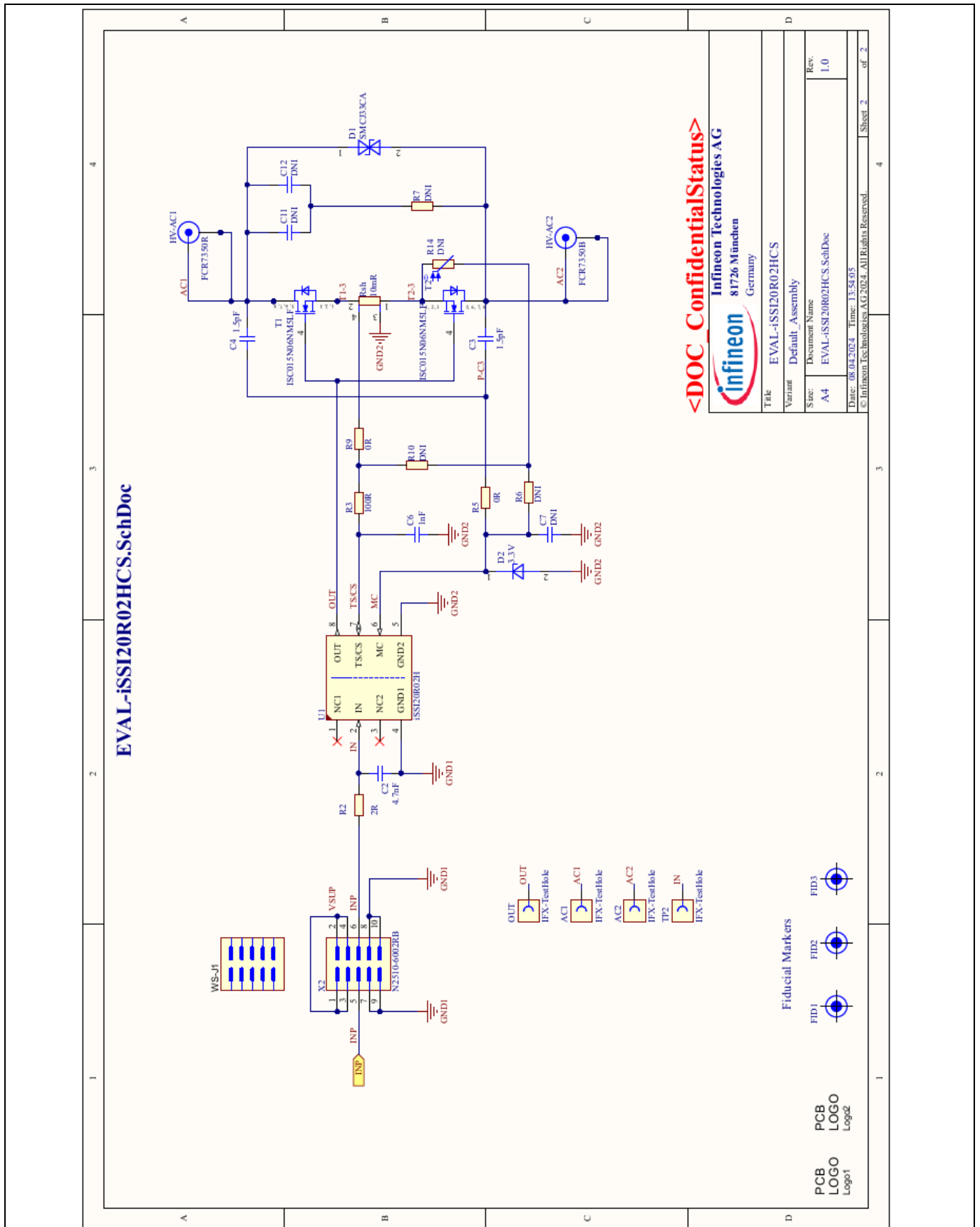

Figure 3 Schematics of EVAL-iSSI20R02HCS (assembled components only)

5 Layout

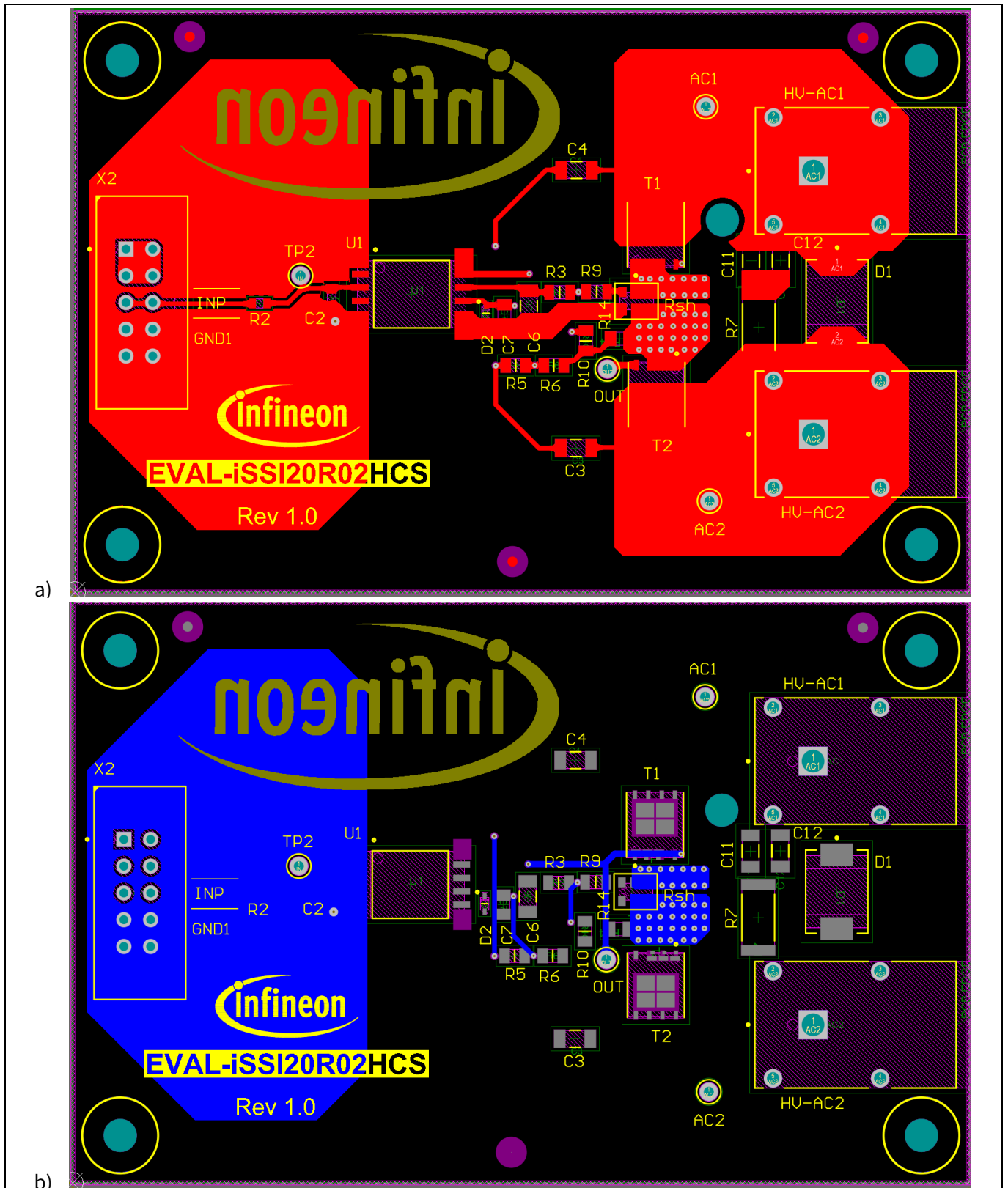

Figure 4 Top (a) and bottom (b) layers of EVAL-iSSI20R02HCS

6 Bill of materials

Table 5 EVAL-iSSI20R02HCS bill of materials

Component	Value	Description	Manufacturer	Part number
C2	4.7nF	CAP / CERA / 4.7nF / 25V / 1% / C0G (EIA) / NP0 / -55°C to 125°C / 0603(1608) / SMD / -	Kemet	C0603C472F3GAC
C3, C4	1.5pF	CAP / CERA / 1.5pF / 2kV / 0.1% / C0G (EIA) / NP0 / -55°C to 125°C / 3.20mm L X 1.60mm W X 0.9mm H / SMD / -	Walsin	1206N1R5B202CT
C6	1nF	CAP / CERA / 1nF / 50V / 10% / X7R (EIA) / -55°C to 125°C / 1206(3216) / SMD / -	MuRata	GRM319R71H102KA01
D1	SMCJ33CA	Surface Mount TVS Diode, 33V, 1uA	Littelfuse	SMCJ33CA
D2	3.3V	DIODE ZENER 3.3V 500MW SOD523	ON Semiconductor	SZMM5Z3V3T1G
HV-AC1	FCR7350R	Banana Test Connector, 4mm, Socket, PCB Mount, 24 A, 1 kV, Gold Plated Contacts, Red	Cliff Electronics Component Limited	FCR7350R
HV-AC2	FCR7350B	Banana Test Connector, 4mm, Socket, PCB Mount, 24 A, 1 kV, Gold Plated Contacts, Black	Cliff Electronics Component Limited	FCR7350B
R2	2R	RES / STD / 2R / 100mW / 1% / 100ppm/K / -55°C to 155°C / 0603(1608) / SMD / -	Vishay	CRCW06032R00FK
R3	100R	RES / STD / 100R / 125mW / 1% / 100ppm/K / -55°C to 155°C / 0805(2012) / SMD / -	Vishay	CRCW0805100RFK
R5	0R	RES / - / 0R / 125mW / - / - / - / 0805(2012) / SMD / -	Multicomp	MCMR08X000 PTL
R9	0R	RES / STD / 0R / - / 0% / - / -55°C to 155°C / 0805(2012) / SMD / -	Vishay	CRCW08050000Z0EA
Rsh	10mR	RES / STD / 10mR / 1W / 1% / 35ppm/K / -55°C to 155°C / 1206(3216) / SMD / -	Susumu	KRL3216T4A-M-R010-F-T1
T1, T2	ISC015N06NM5LF	OptiMOS 5 Linear FET with the Features of Very Low On-Resistance	Infineon Technologies	ISC015N06NM5LF
U1	iSSI20R02H	Coreless-Transformer Advanced Solid-State Isolator	Infineon Technologies	iSSI20R02H
X2	N2510-6002RB	Header, 4-Wall Lo-PRO, .100, Straight, 10Pins, 2.54mm Pitch	3M	N2510-6002RB



Revision history

Document revision	Date	Description of changes
1.0	2024-04-10	Initial version

Trademarks

All referenced product or service names and trademarks are the property of their respective owners.

Edition 2024-04-10

Published by

Infineon Technologies AG

81726 Munich, Germany

© 2024 Infineon Technologies AG.

All Rights Reserved.

Do you have a question about this document?

Email: erratum@infineon.com

Document reference

UG-2023-18

For further information on the product, technology, delivery terms and conditions and prices please contact your nearest Infineon Technologies office (www.infineon.com).

WARNINGS

Due to technical requirements products may contain dangerous substances. For information on the types in question please contact your nearest Infineon Technologies office.

Except as otherwise explicitly approved by Infineon Technologies in a written document signed by authorized representatives of Infineon Technologies, Infineon Technologies' products may not be used in any applications where a failure of the product or any consequences of the use thereof can reasonably be expected to result in personal injury.

X-ON Electronics

Largest Supplier of Electrical and Electronic Components

Click to view similar products for [Power Management IC Development Tools](#) category:

Click to view products by [Infineon](#) manufacturer:

Other Similar products are found below :

[EVB-EP5348UI](#) [BQ25010EVM](#) [ISL80019AEVAL1Z](#) [ISLUSBI2CKIT1Z](#) [ISL8002AEVAL1Z](#) [ISL91108IIA-EVZ](#) [MAX8556EVKIT](#)
[MAX15005AEVKIT+](#) [ISL28022EVKIT1Z](#) [STEVAL-ISA008V1](#) [DRI0043](#) [KITPF8100FRDMEVM](#) [EVB-EN6337QA](#)
[SAMPLEBOXILD8150TOBO1](#) [MAX18066EVKIT#](#) [AP62300WU-EVM](#) [KITA2GTC387MOTORCTRTOBO1](#) [AEK-MOT-TK200G1](#)
[EVLONE65W](#) [STEVAL-ILH006V1](#) [STEVAL-IPE008V2](#) [STEVAL-IPP001V2](#) [STEVAL-ISA013V1](#) [STEVAL-ISA067V1](#) [STEVAL-](#)
[ISQ002V1](#) [TPS2306EVM-001](#) [TPS2330EVM-185](#) [TPS40001EVM-001](#) [SECO-HVDCDC1362-15W-GEVB](#) [BTS7030-2EPA](#)
[LT8638SJV#WPBF](#) [LTC3308AIV#WTRPBF](#) [TLT807B0EPV](#) [BTS71033-6ESA](#) [EV13N91A](#) [EASYPIC V8 OVER USB-C](#) [EV55W64A](#)
[CLICKER 4 FOR STM32F4](#) [EASYMX PRO V7A FOR STM32](#) [CLICKER 4 FOR PIC18F](#) [Si8285_86v2-KIT](#) [PAC52700EVK1](#) [NCP-](#)
[NCV51752D2PAK3LGEVB](#) [ISL81807EVAL1Z](#) [AP33772S-EVB](#) [EVALM7HVIGBTFCINV4TOBO1](#) [903-0300-000](#) [902-0173-000](#) [903-](#)
[0301-000](#) [ROA1286023/1](#)