

# TDA38806 P1V8 user guide

## User guide for TDA38806 evaluation board

### About this document

#### Scope and purpose

The TDA38806 is a synchronous buck regulator, providing a compact, high performance and flexible solution in a small 2mm X 3mm QFN package.

Key features offered by the TDA38806 include internal Soft Start, precision 0.6V reference voltage, Power Good, thermal protection, programmable switching frequency in the range of 600 kHz to 2 MHz, softstart, Enable input, input under-voltage lockout for proper start-up, latched off over voltage protection, over current protection and pre-bias start-up.

This user guide contains the schematic and bill of materials for the EVAL\_TDA38806\_1.8VOUT engineering evaluation board. The guide describes operation and use of the evaluation board itself. Detailed application information for TDA38806 is available in the TDA38806 data sheet.

#### Intended audience

This document is intended as a guide for design engineers evaluating TDA38806 performance with the engineering EVAL\_TDA38806\_1.8VOUT demo board



## Table of contents

<b>About this document</b> .....	<b>1</b>
<b>Table of contents</b> .....	<b>2</b>
<b>1 TDA38806 Features</b> .....	<b>3</b>
<b>Features</b> .....	<b>3</b>
<b>Potential applications</b> .....	<b>3</b>
<b>Product validation</b> .....	<b>3</b>
<b>Description</b> .....	<b>3</b>
<b>2 Board information</b> .....	<b>4</b>
2.1 Evaluation Board.....	4
2.2 Board features .....	4
2.3 Connections and operating instructions.....	5
2.4 Layout .....	5
2.5 PCB Layout .....	6
2.6 Schematic.....	8
2.7 Bill of materials.....	9
<b>3 Evaluation Board Test Results</b> .....	<b>12</b>
3.1 Typical Performance Curves and Waveforms .....	13
<b>Revision history</b> .....	<b>19</b>

# 1 TDA38806 Features

## Features

- Wide Input Voltage Range: 4 V to 16 V with internal bias and 2.7 V to 16 V with external VCC (3.3 V)
- Precision Reference Voltage (0.6 V +/- 0.5%)
- Stable with Ceramic Output Capacitors
- No External Compensation
- Optional Forced Continuous Conduction Mode and Diode Emulation for Enhanced Light Load Efficiency
- Selectable Switching Frequency from 600 kHz, 1100 kHz, and 2 MHz
- Programmable Soft-Start Time with a minimum of 1 ms & Enhanced Pre-Bias Start-Up
- Voltage Tracking with External Reference Input
- Programmable Over Current Protection Limit with internal thermal compensation
- Enable input with Voltage Monitoring Capability
- Power Good Output
- Non-Latch OCP, UVP, Thermal Shutdown, and Latch-Off OVP
- Operating Temp:  $-40\text{ }^{\circ}\text{C} < T_j < 125\text{ }^{\circ}\text{C}$
- Small Size: 2 mm x 3 mm QFN-14
- Lead-free, Halogen-free and RoHS Compliant

## Potential applications

- Server Applications
- Storage Applications
- Telecom & Datacom Applications
- Distributed Point of Load Power Architectures

## Product validation

Qualified for industrial applications according to the relevant tests of JEDEC47/20/22

## Description

The TDA38806 is a 6 A fully integrated and highly efficient DC - DC Buck regulator. It uses a fast Constant On-Time (COT) control scheme, which simplifies the design efforts and achieves fast control response during the transients while maintaining excellent line and load regulation. It can operate over a wide range of input voltage (2.7 V to 16 V) using an external bias supply.

TDA38806 is a versatile regulator, offering switching frequency selectable from 600 kHz, 1.1 MHz and 2 MHz, programmable current limit and soft-start time with a minimum of 1 ms, Forced Continuous Conduction Mode (FCCM) and Diode Emulation Mode (DEM) operation using jumper settings. The EVAL board can be turned on or off via a remote on/off input (EN) that is referenced to ground. This input is compatible with logic devices.

## 2 Board information

### 2.1 Evaluation Board



### 2.2 Board features

$V_{in} = +12\text{ V}$ ,  $V_{out} = +1.8\text{ V}$  @ 0- 6 A

$F_s = 600\text{ kHz}/1100\text{ kHz}/2000\text{ kHz}$

$L = 1\text{ uH}$

$C_{in} = 2 \times 10\text{ uF}$  (25 V, ceramic 0805) + 2 x 4.7 uF (25 V, ceramic 0805)

$C_{out} = 6 \times 47\text{ uF}$  (6.3 V, ceramic 0805)

## 2.3 Connections and operating instructions

TDA38806 demo board requires a single +12 V for the input power and can deliver up to 6A load current. The operation modes and OCP limits can be selected through jumpers and resistors

Label		Descriptions
Input	VIN	Connect input power (+12 V) to this pin
	GND	Return of input power
	VIN_TP2 GND_TP10	Sense pins for the input voltage
Output	VOUT	V <sub>out</sub> (+1.8V), connect a DC load (6A max) to this pin
	GND	Return of Vout
	VOUT_TP4, GND_TP5	Sense pins for the output voltage
Enable	EN	Connect a scope probe to this pin to monitor Enable Signal
	GND	Or, an external Enable signal can be applied to this Pin to overdrive the on-board Enable signal
Soft Start	TK/VREF	Connect a capacitor to this pin to get different soft-start times
Mode	FCCM	Use a jumper to select FCCM or DEM, and switching frequency. Three preset switching frequencies are: 600kHz, 1100kHz, 2000kHz.
	DEM	
CS		Use a resistor to connect to CS to configure the current limit
PGood	PGOOD	Connect a scope probe to this pin to monitor Power Good Signal
	GND	GND
GND	GND	Board Ground
	GND	
Vcc	Vcc	Standard demo board is configured to use the internal LDO. Connect a scope probe to this pin to minitor the output of the internal LDO.
	GND	

## 2.4 Layout

The PCB is a 4-layer board using FR4 material. Top and bottom layers use 2Oz copper and inner layers use 1Oz. copper. The PCB thickness is 1.6mm. The TDA38806 and other major power components are mounted on the top side of the board.

## 2.5 PCB Layout

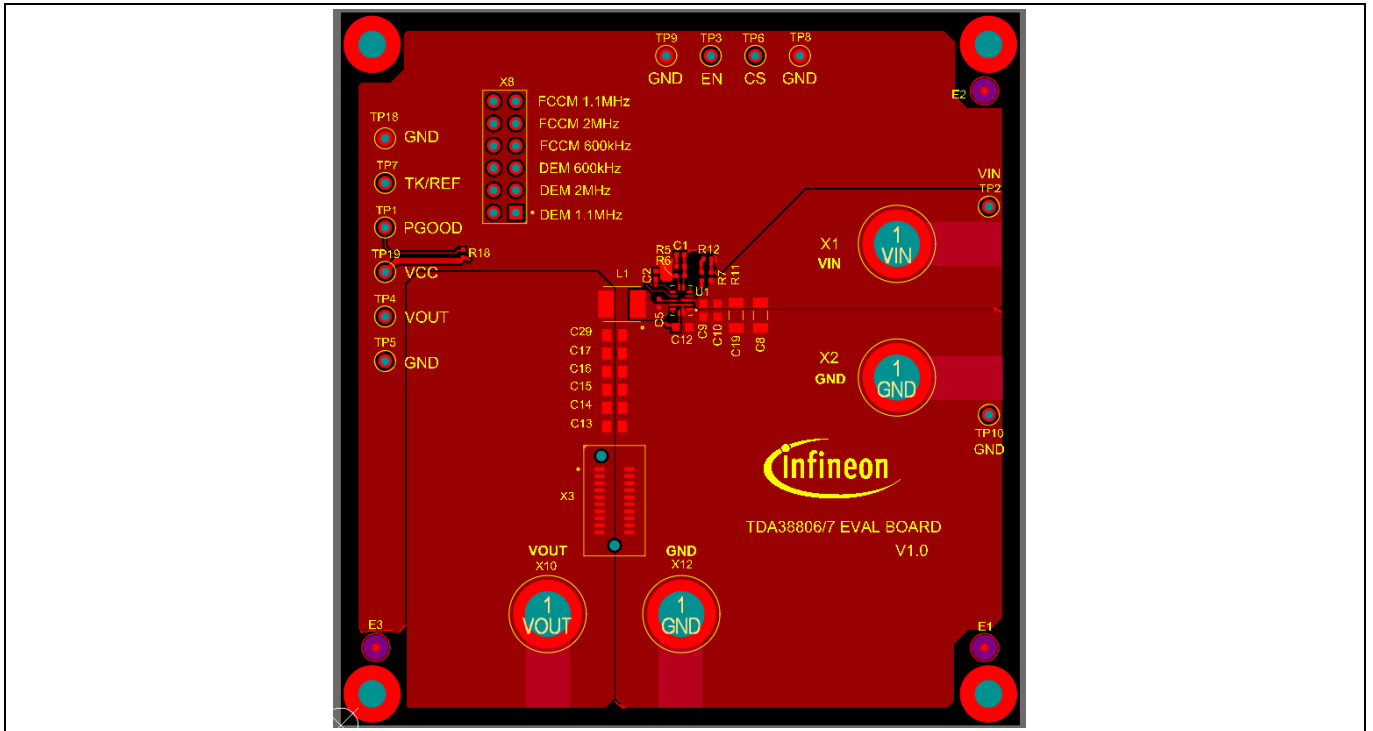

**Figure 1** Top Layer

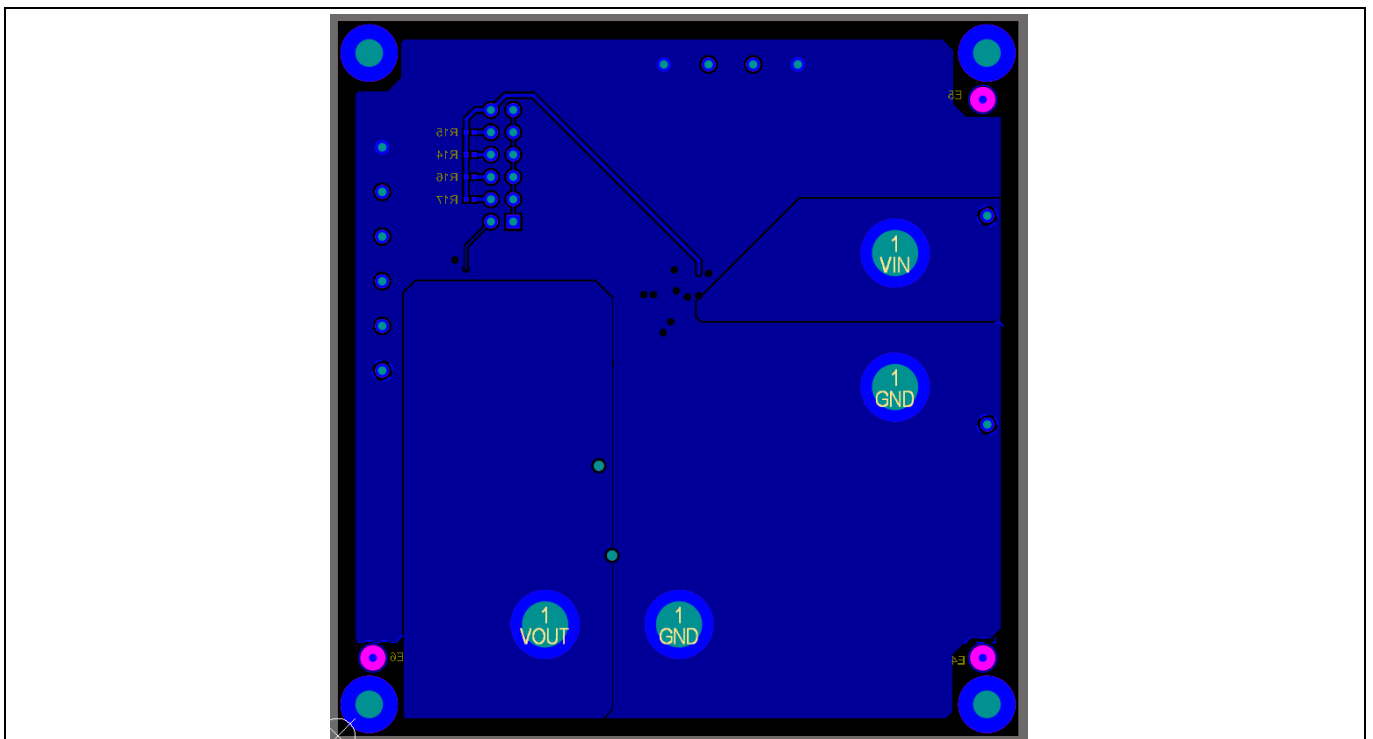

**Figure 2** Bottom Layer

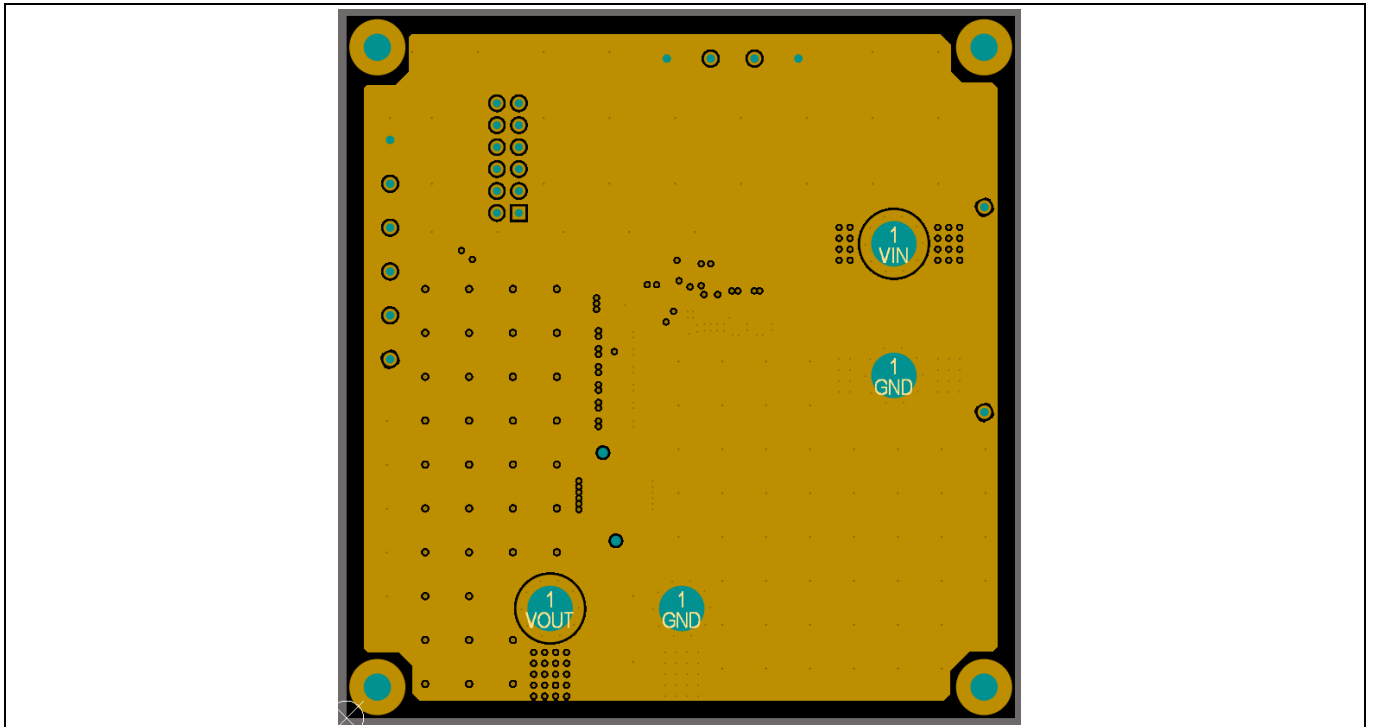

Figure 3 Inner Layer 1

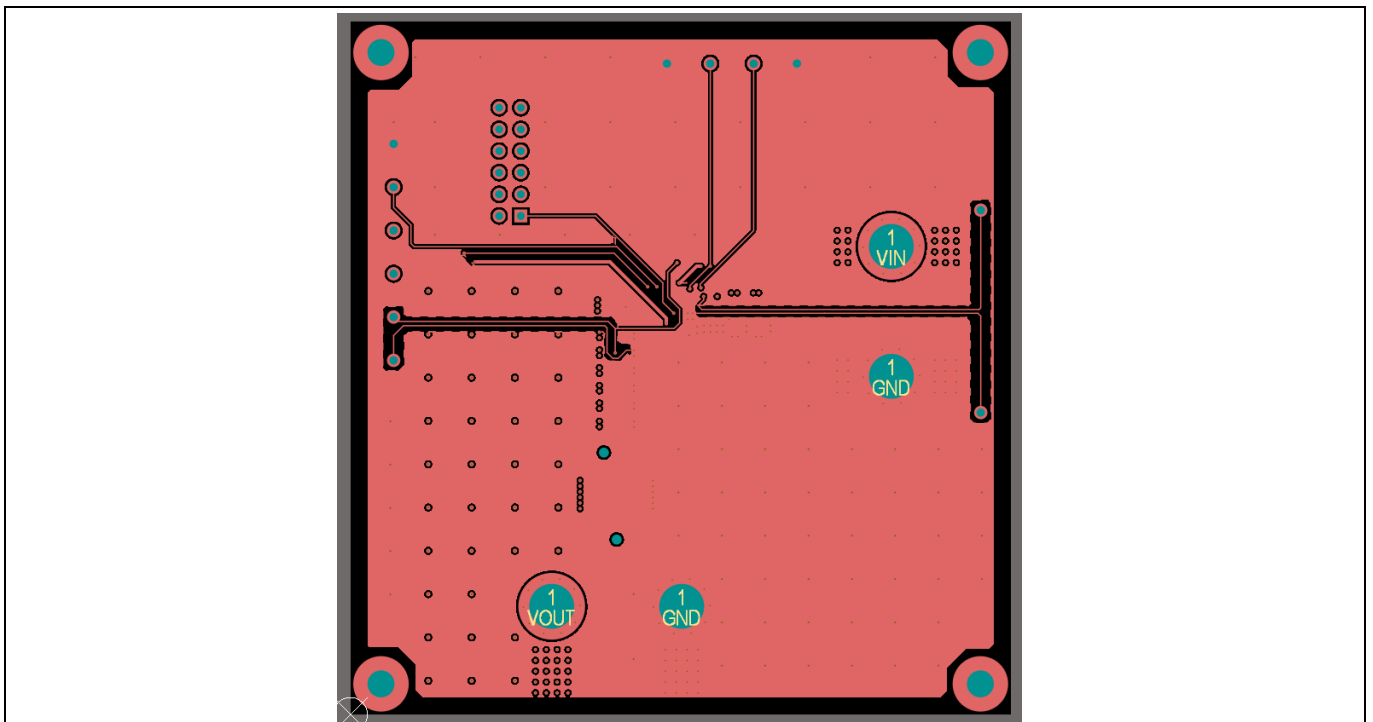
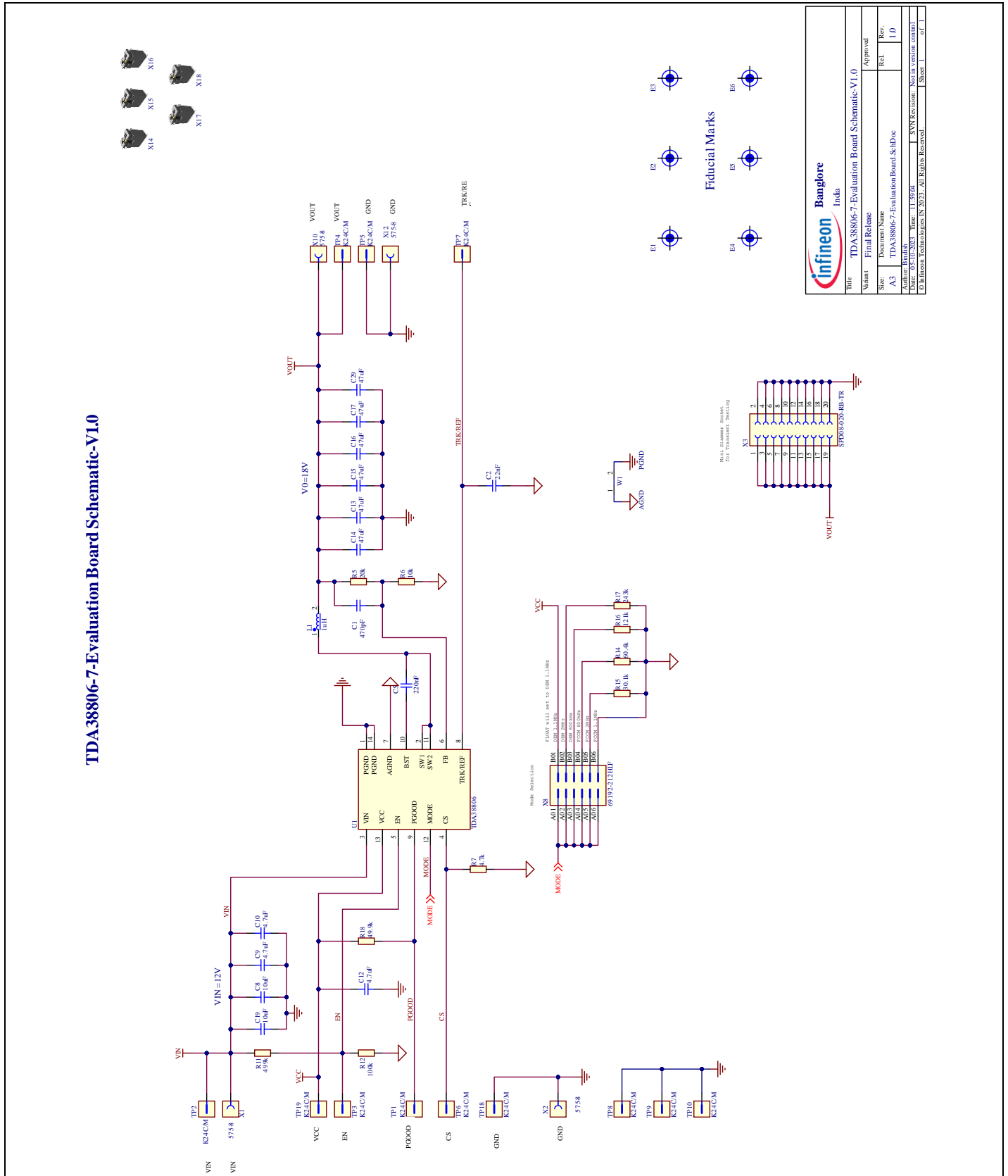

Figure 4 Inner Layer2

## 2.6 Schematic



infinion Bangalore India	
Title	TDA38806-7-Evaluation Board Schematic-V1.0
Variant	Final Release
Document Name	Approval
Size	Rev.
A3	TDA38806-7-Evaluation Board_SchDoc
Author: Ependah	1.0
Date: 05-10-2023	Time: 11:59:04
© Infineon Technologies AG 2023. All Rights Reserved.	Not in version control
Sheet 1	of 1

**Figure 5 Schematic of the TDA38806 evaluation board Vin = 12 V, Vo = 1.8V, Ioutmax = 6A**



## 2.7 Bill of materials

Table 1 Bill of Materials

Item #	Qty	Value	Part Reference	Description	Manufacturer	PART_NUMBER
1	1	C1	470pF	CAP / CERA / 470pF / 16V / 10% / X7R (EIA) / -55°C to 125°C / 1.00mm L X 0.50mm W X 0.56mm H / SMD / -	AVX	0402YC471KAT2A
2	1	C2	22nF	CAP / CERA / 22nF / 16V / 10% / X7R (EIA) / -55°C to 125°C / 1.00mm L X 0.50mm W X 0.55mm H / SMD / -	Samsung	CL05B223KO5VPNC
3	1	C5	220nF	CAP / CERA / 220nF / 16V / 10% / X7R (EIA) / -55°C to 125°C / 1.00mm L X 0.50mm W X 0.55mm H / SMD / -	TDK Corporation	C1005X7R1C224K050BC
4	2	C8, C19	10uF	CAP / CERA / 10uF / 25V / 10% / X7R (EIA) / -55°C to 125°C / 1206(3216) / SMD / -	MuRata	GRM31CR71E106KA12
5	3	C9, C10, C12	4.7uF	CAP / CERA / 4.7uF / 25V / 10% / X6S (EIA) / -55°C to 105°C / 1.60mm L X 0.80mm W X 1.00mm H / SMD / -	MuRata	GRT188C81E475KE13D
6	6	C13, C14, C15, C16, C17, C29	47uF	CAP / CERA / 47uF / 6.3V / 20% / X5R (EIA) / -55°C to 85°C / 2.00mm L X 1.25mm W X 1.45mm H / SMD / -	MuRata	GRT21BR60J476ME13L
7	1	L1	1uH	IND / STD / 1uH / 8.9A / 20% / -55°C to 165°C / 10.5mR / SMD / Inductor, Molded	Cyntec	VCHA042A-1R0MS6

				Body;4.20mm L X 4.00mm W X 2.10mm H / SMD / -		
8	1	R5	20k	RES / STD / 20k / 63mW / 5% / 100ppm/K / -55°C to 155°C / 0402(1005) / SMD / -	Yageo	RC0402JR-0720KL
9	1	R6	10k	RES / STD / 10k / 63mW / 5% / 100ppm/K / -55°C to 155°C / 0402(1005) / SMD / -	Yageo	RC0402JR-0710KL
10	1	R7	4.7k	RES / STD / 4.7k / 63mW / 1% / 100ppm/K / -55°C to 155°C / 0402(1005) / SMD / -	Vishay	CRCW04024K70FK
11	1	R11	499k	RES / STD / 499k / 63mW / 1% / 100ppm/K / -55°C to 155°C / 0402(1005) / SMD / -	Yageo	RC0402FR-07499KL
12	1	R12	100k	RES / STD / 100k / 63mW / 5% / 100ppm/K / -55°C to 155°C / 0402(1005) / SMD / -	Yageo	RC0402JR-07100K
13	1	R14	60.4k	RES / STD / 60.4k / 63mW / 1% / 100ppm/K / -55°C to 155°C / 0402 (1005) / SMD / -	Yageo	RC0402FR-0760K4L
14	1	R15	30.1k	RES / STD / 30.1k / 63mW / 1% / 100ppm/K / -55°C to 155°C / 0402(1005) / SMD / -	Yageo	RC0402FR-0730K1L
15	1	R16	121k	RES / STD / 121k / 63mW / 1% / 100ppm/K / -55°C to 155°C / 0402(1005) / SMD / -	Yageo	RC0402FR-07121KL
16	1	R17	243k	RES / STD / 243k / 63mW / 1% / 100ppm/K / -55°C to 155°C / 0402(1005) / SMD / -	Yageo	RC0402FR-07243KL

17	1	R18	49.9k	RES / STD / 49.9k / 63mW / 1% / 100ppm/K / -55°C to 155°C / 0402(1005) / SMD / -	Yageo	RC0402FR-0749K9L
18	12	TP1, TP2, TP3, TP4, TP5, TP6, TP7, TP8, TP9, TP10, TP18, TP19	K24C/M	Test Point THT, Inbord Pin, Straight PCB Terminal	Vector	K24C/M
19	1	U1		High Efficiency, Synchronous, Step-Down Converter with Adjustable Current Limit	Infineon Technologies	TDA38806
20	4	X1, X2, X10, X12	575-8	Non Insulated Jack, Brass	Keystone Electronics Corp.	575-8
21	1	X3	SPD08-020-RB-TR	SPD08 High Speed Card Edge Connector, 0.8MM Pitch SMD, 20Pins, 1.2A, 250V	3M	SPD08-020-RB-TR
22	1	X8	69192-212HLF	BergStik, Board to Board connector. 2.54mm Pitch, 12 pins, 6pins per Row, Dual row, Unshrouded vertical header	Amphenol	69192-212HLF

### 3 Evaluation Board Test Results

All Performance curves and Waveforms are tested on the evaluation board.

$V_{IN} = 12V$ ,  $V_{OUT} = 1.8V$ ,  $L = 1\mu H$ ,  $T_A = +25^{\circ}C$ , unless otherwise noted

$V_{IN} = 12V$ ,  $V_{CC} = \text{internal LDO}$ ,  $I_{out} = 0A - 6A$ ,  $F_{sw} = 1100\text{ kHz}$ , room temperature, natural convection. Note that the efficiency and power loss curves include losses of the TDA38806, inductor losses, losses of the input and output capacitors, and PCB trace losses. [Table 2](#) shows the inductors used for each of the output voltages in the efficiency measurement.

**Table 2 Inductors for  $V_{IN} = 12V$ ,  $F_{sw} = 800\text{ kHz}$**

Vout (V)	Lout (nH)	P/N	DCR (mΩ)	Size (mm)
1.8V, 3.3V, 5V	1000	VCHA042A-1R0MS6	10.5	4.2 L X 4.0 W X 2.1 H

### 3.1 Typical Performance Curves and Waveforms

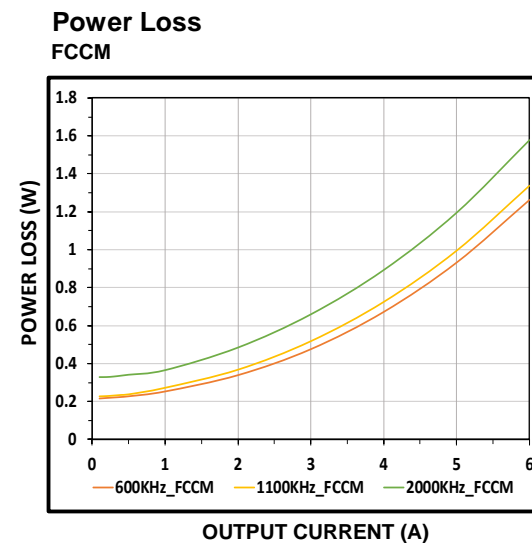
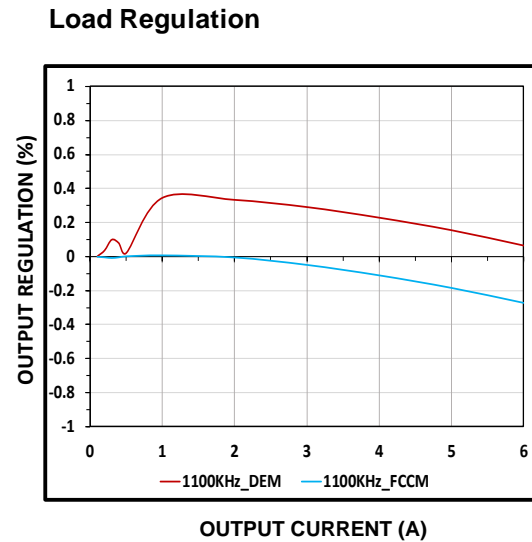
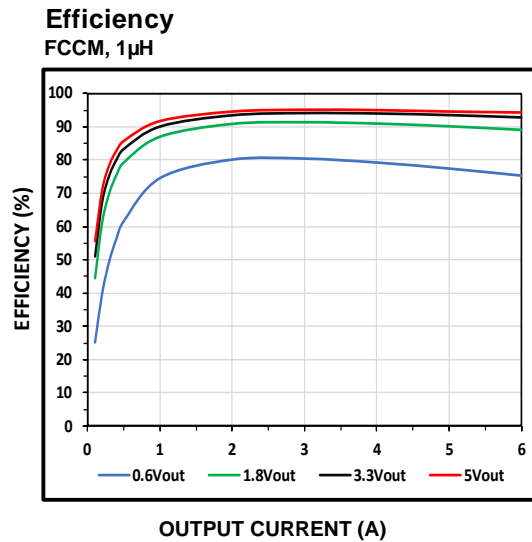
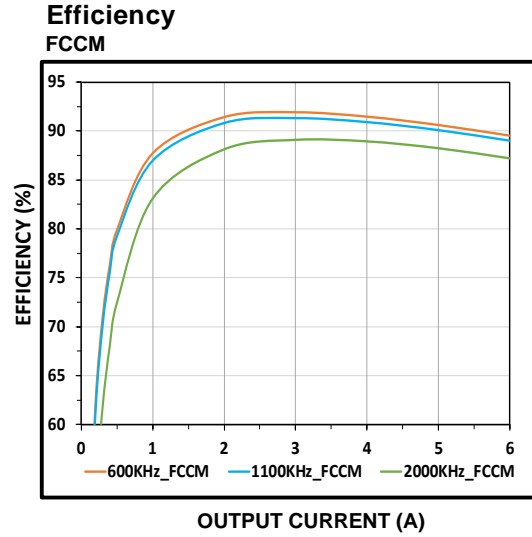
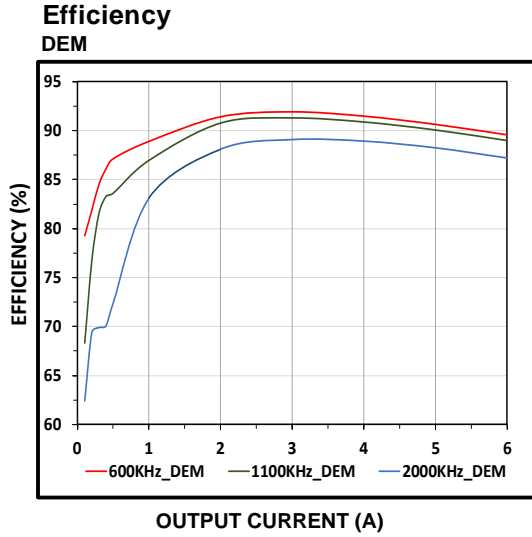

**Switching Frequency vs Output Current**

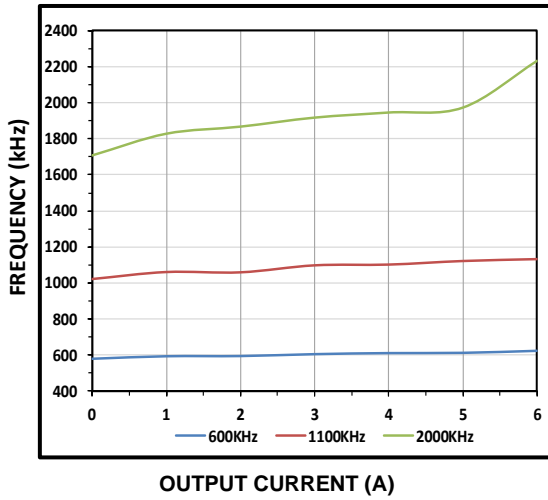

**Thermal No Air-Flow**

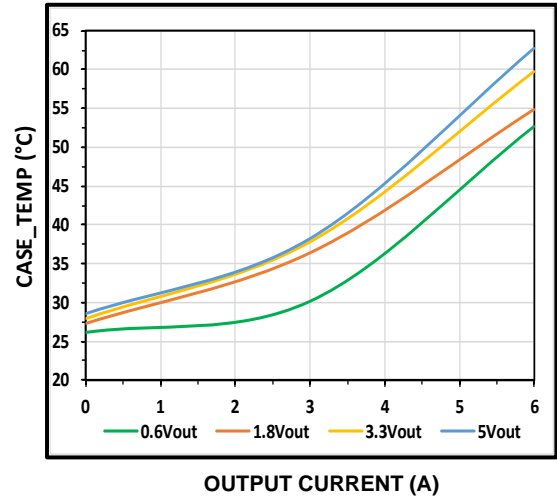

**Thermal Derating**

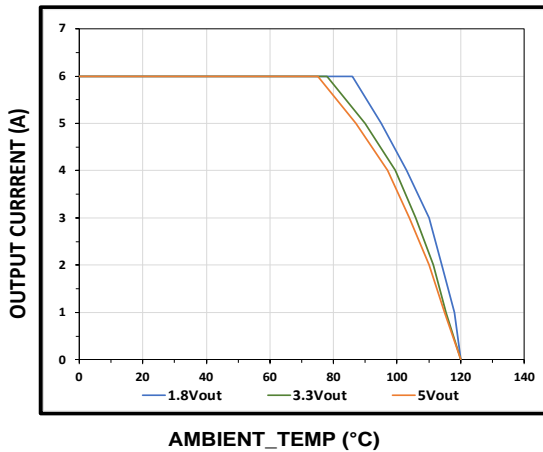

**Steady State IOUT = 0A, DEM**

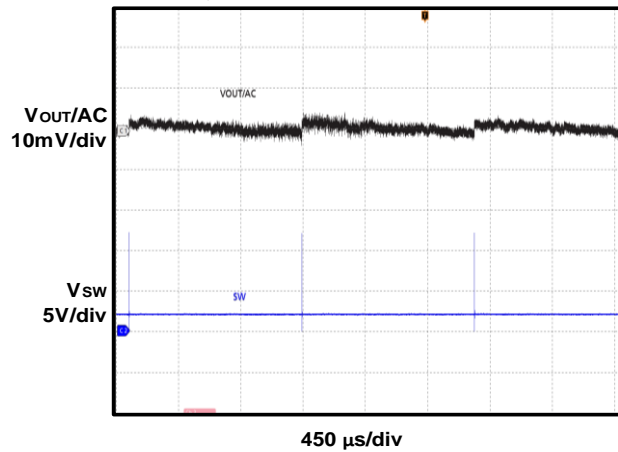

**Steady State IOUT = 0.5A, DEM**

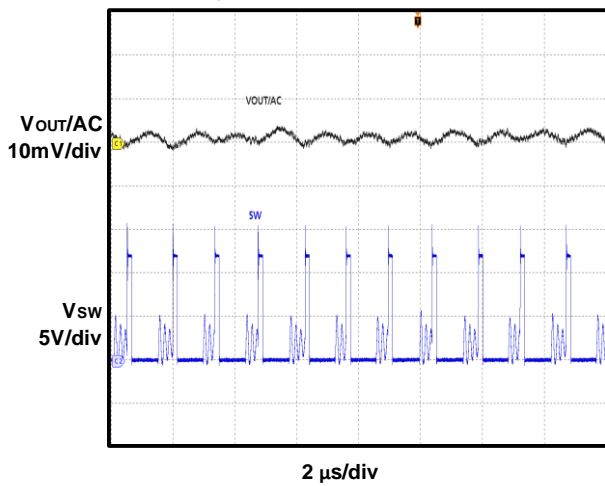

**Steady State IOUT = 6A, DEM**

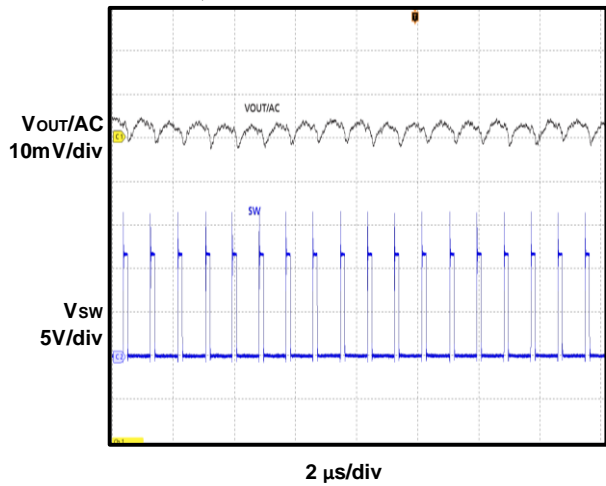

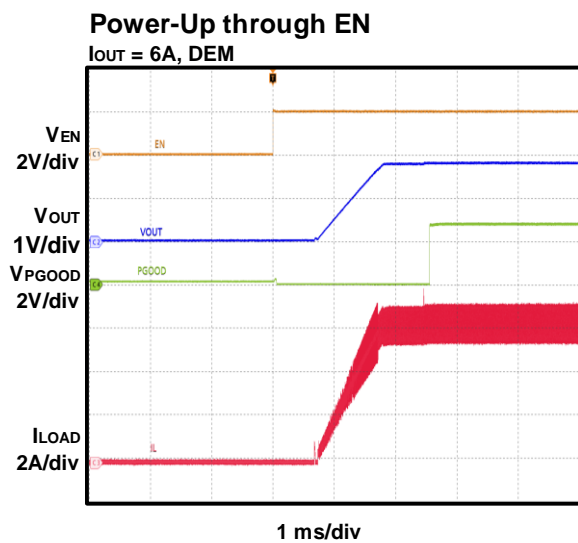
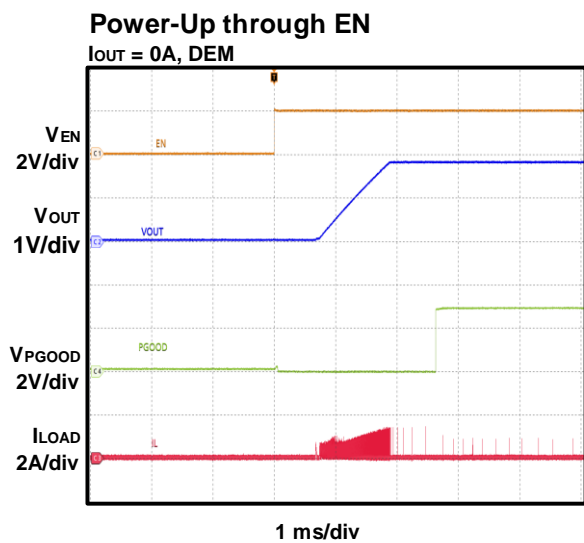
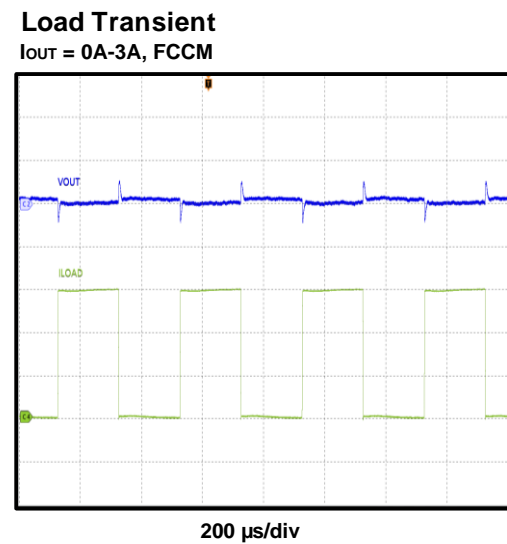
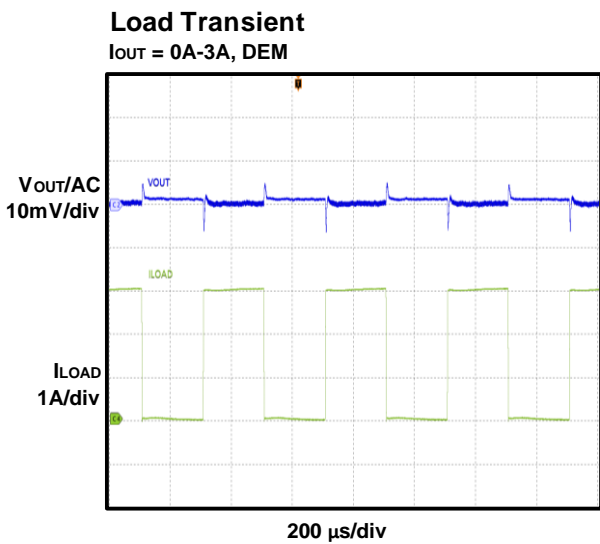
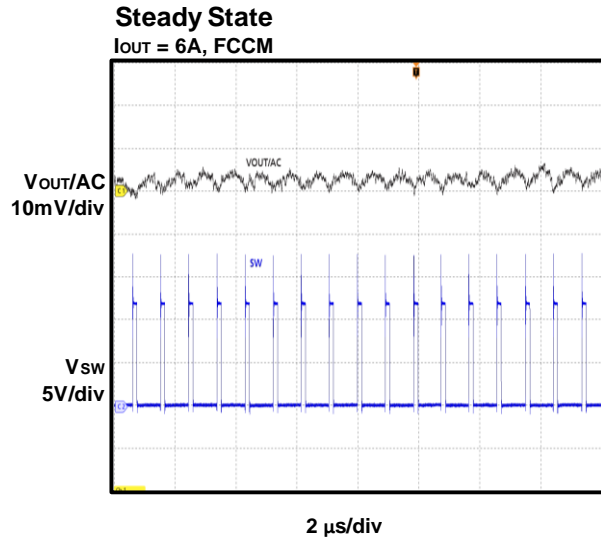
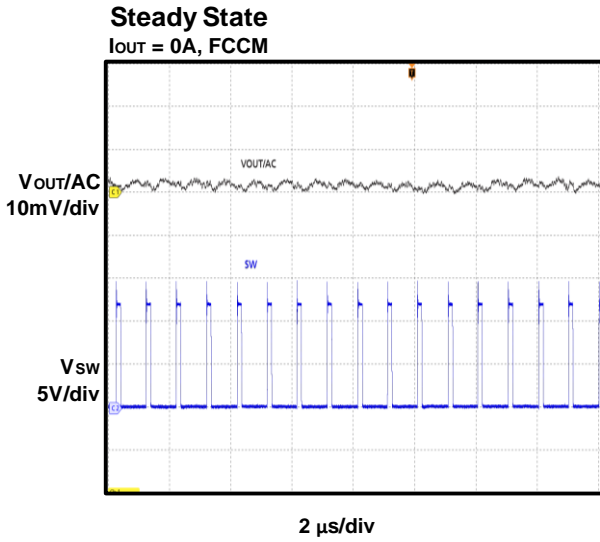

**Power-Up through EN**

I<sub>OUT</sub> = 0A, FCCM

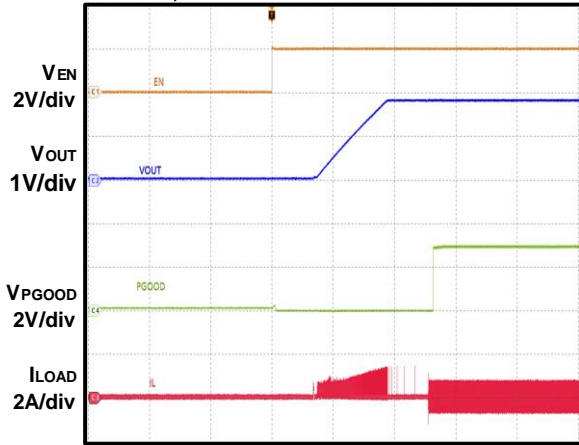

1 ms/div

**Power-Up through EN**

I<sub>OUT</sub> = 6A, FCCM

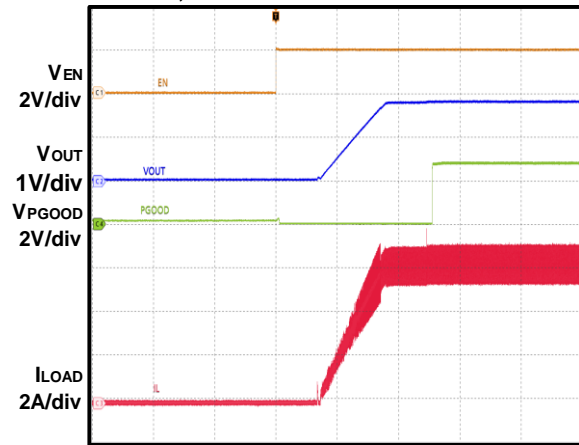

1 ms/div

**Power-Down through EN**

I<sub>OUT</sub> = 0A, DEM

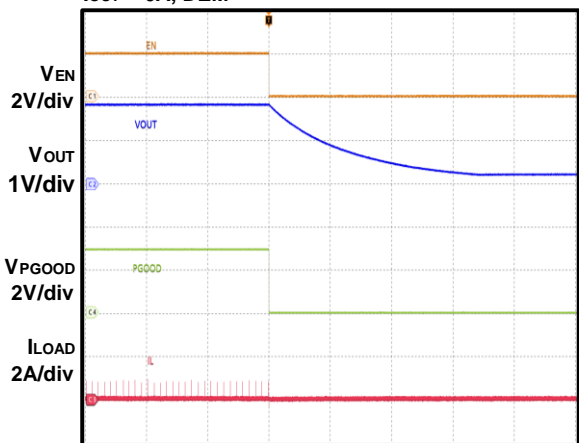

10 ms/div

**Power-Down through EN**

I<sub>OUT</sub> = 6A, DEM

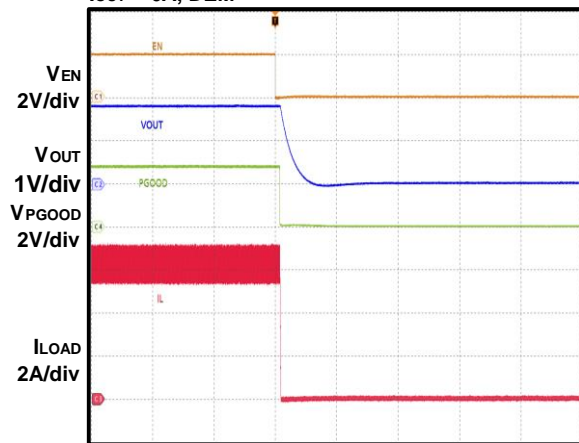

200 μs/div

**Power-Down through EN**

I<sub>OUT</sub> = 0A, FCCM

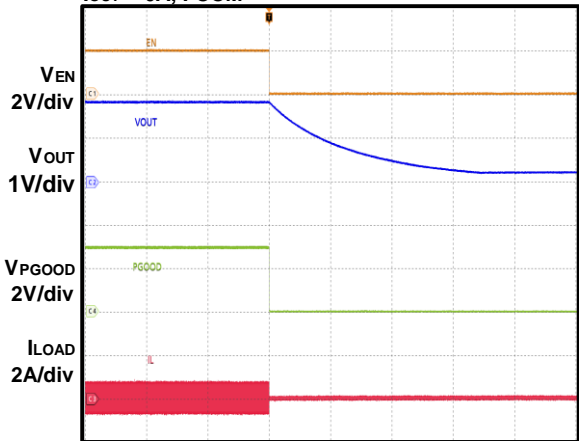

10 ms/div

**Power-Down through EN**

I<sub>OUT</sub> = 6A, FCCM

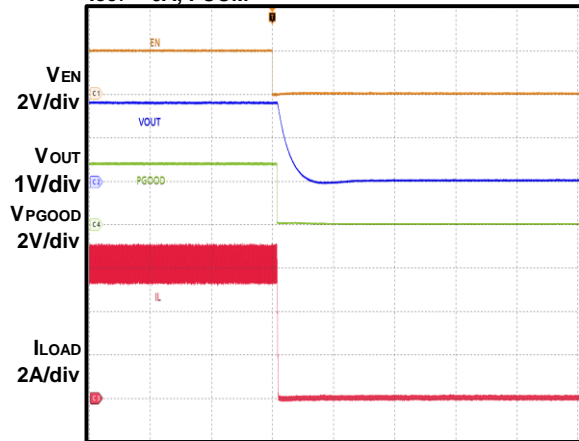

200 μs/div



**Pre-Bias Start-Up**  
**DEM**

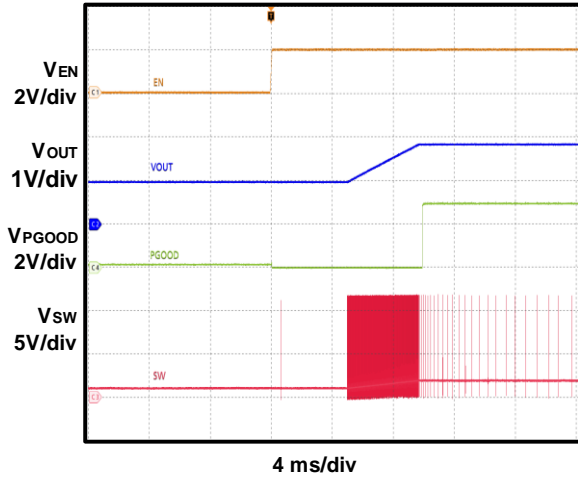

**Pre-Bias Start-Up**  
**FCCM**

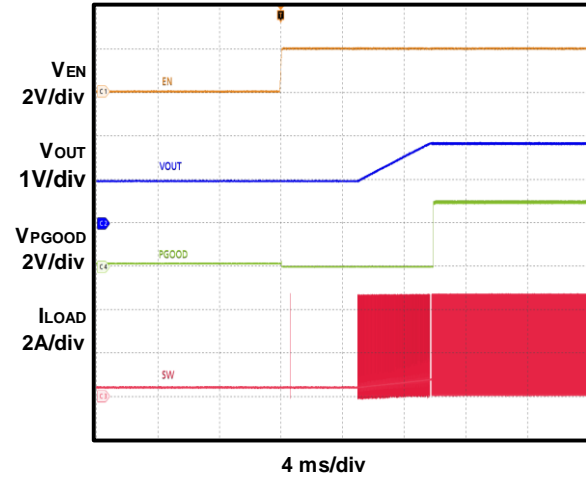

**Over-Current Protection**  
**DEM**

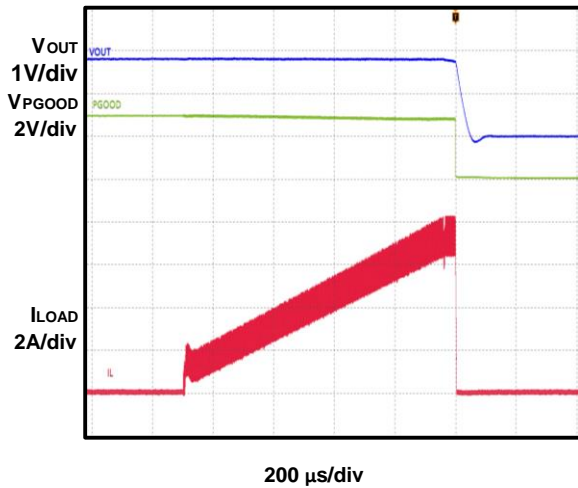

**Over-Current Protection**  
**FCCM**

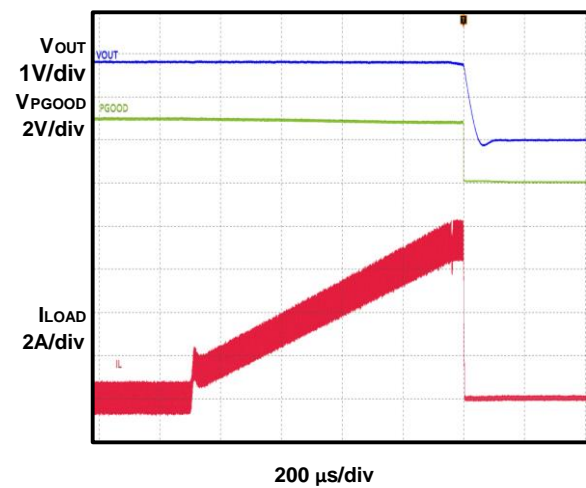

**OSM Operation**  
**DEM**

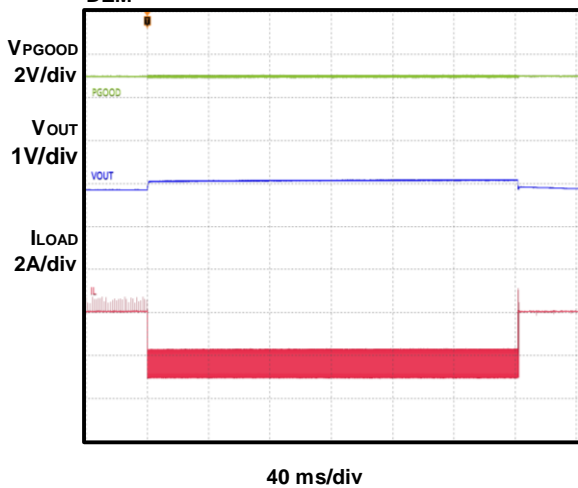

**OSM Operation**  
**FCCM**

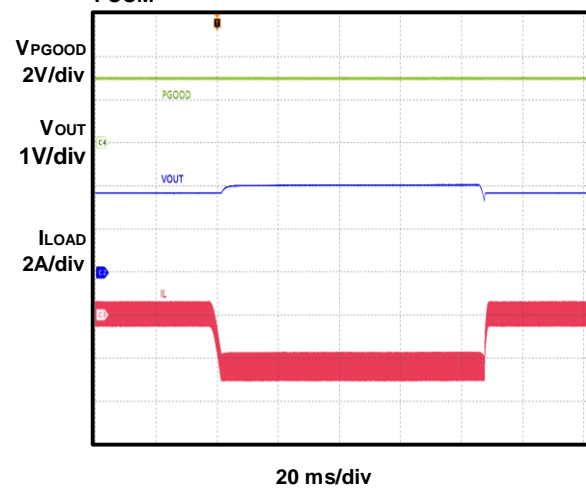

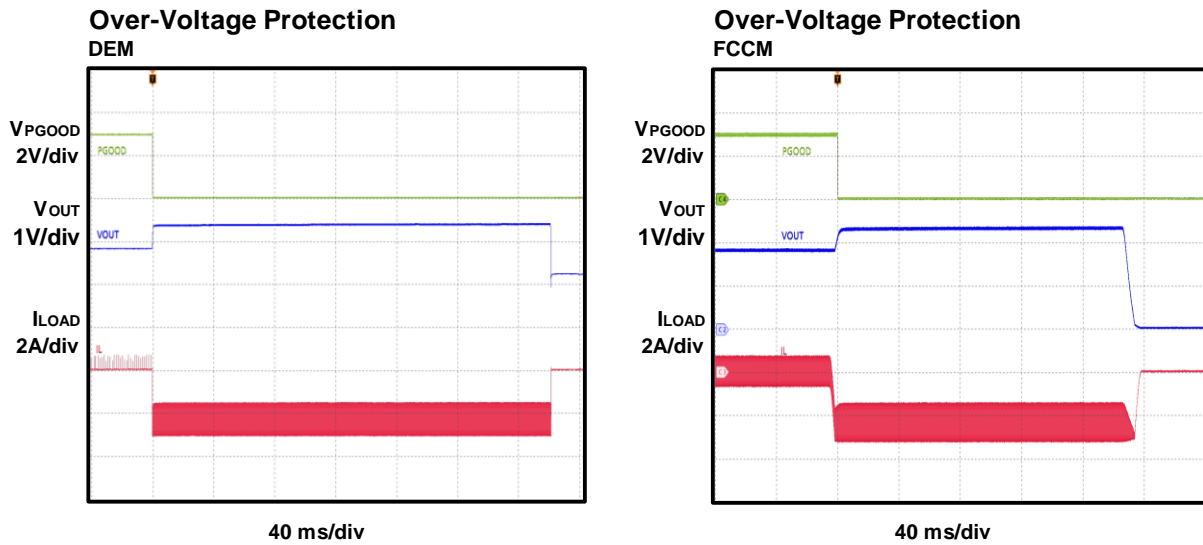

## START GUIDE

The EVAL Board can be tested from 8V to 16V Input voltage. The minimum 8V input voltage is limited by the EN signal, which is derived from VIN through a resistor divider (R11 and R12).

A lower input voltage (as low as 2.7V with external 3.3V VCC bias) can be set by adjusting the resistor divider values or by connecting EN with an external control signal.

The steps below outline the procedure to start and work on the EVAL Board

- Connect the positive and negative terminals of the load to the VOUT and GND pins, respectively.
- Preset the power supply output voltage between 8V and 16V, and then turn off the power supply.
- Connect the positive and negative terminals of the power supply output to the VIN and GND pins, respectively. Ensure that the power supply has a current limit high enough to supply the power.
- Turn the power supply on. The EVAL Board will Power up automatically.
- To use the enable function, apply a digital input to the EN pin. Drive EN above 1.2V to turn on the regulator. Drive EN below 1V to turn off the regulator.
- Use R5 and R6 to set the output voltage with  $V_{FB} = 0.6V$ .
- The X8 jumper can be used to select the operating frequency (600kHz, 1100kHz, or 2000kHz) and select FCCM or DEM mode



## Revision history

<b>Document version</b>	<b>Date of release</b>	<b>Description of changes</b>
1.0	2023-05-10	Final User Guide

#### Trademarks

All referenced product or service names and trademarks are the property of their respective owners.

**Edition 2023-10-05**

**Published by**

**Infineon Technologies AG**

**81726 Munich, Germany**

**© 2023 Infineon Technologies AG.**

**All Rights Reserved.**

**Do you have a question about this document?**

**Email: [erratum@infineon.com](mailto:erratum@infineon.com)**

**Document reference**

**UG\_201802\_PL12\_xx**

#### IMPORTANT NOTICE

The information given in this document shall in no event be regarded as a guarantee of conditions or characteristics ("Beschaffenheitsgarantie").

With respect to any examples, hints or any typical values stated herein and/or any information regarding the application of the product, Infineon Technologies hereby disclaims any and all warranties and liabilities of any kind, including without limitation warranties of non-infringement of intellectual property rights of any third party.

In addition, any information given in this document is subject to customer's compliance with its obligations stated in this document and any applicable legal requirements, norms and standards concerning customer's products and any use of the product of Infineon Technologies in customer's applications.

The data contained in this document is exclusively intended for technically trained staff. It is the responsibility of customer's technical departments to evaluate the suitability of the product for the intended application and the completeness of the product information given in this document with respect to such application.

For further information on the product, technology, delivery terms and conditions and prices please contact your nearest Infineon Technologies office ([www.infineon.com](http://www.infineon.com)).

#### WARNINGS

Due to technical requirements products may contain dangerous substances. For information on the types in question please contact your nearest Infineon Technologies office.

Except as otherwise explicitly approved by Infineon Technologies in a written document signed by authorized representatives of Infineon Technologies, Infineon Technologies' products may not be used in any applications where a failure of the product or any consequences of the use thereof are reasonably be expected to result in personal injury.

## X-ON Electronics

Largest Supplier of Electrical and Electronic Components

*Click to view similar products for [Power Management IC Development Tools](#) category:*

*Click to view products by [Infineon](#) manufacturer:*

Other Similar products are found below :

[EVB-EP5348UI](#) [BQ25010EVM](#) [ISL80019AEVAL1Z](#) [ISLUSBI2CKIT1Z](#) [ISL8002AEVAL1Z](#) [ISL91108IIA-EVZ](#) [MAX8556EVKIT](#)  
[MAX15005AEVKIT+](#) [ISL28022EVKIT1Z](#) [STEVAL-ISA008V1](#) [DRI0043](#) [KITPF8100FRDMEVM](#) [EVB-EN6337QA](#)  
[SAMPLEBOXILD8150TOBO1](#) [MAX18066EVKIT#](#) [AP62300WU-EVM](#) [KITA2GTC387MOTORCTRTOBO1](#) [AEK-MOT-TK200G1](#)  
[EVLONE65W](#) [STEVAL-ILH006V1](#) [STEVAL-IPE008V2](#) [STEVAL-IPP001V2](#) [STEVAL-ISA013V1](#) [STEVAL-ISA067V1](#) [STEVAL-](#)  
[ISQ002V1](#) [TPS2306EVM-001](#) [TPS2330EVM-185](#) [TPS40001EVM-001](#) [SECO-HVDCDC1362-15W-GEVB](#) [BTS7030-2EPA](#)  
[LT8638SJV#WPBF](#) [LTC3308AIV#WTRPBF](#) [TLT807B0EPV](#) [BTS71033-6ESA](#) [EV13N91A](#) [EASYPIC V8 OVER USB-C](#) [EV55W64A](#)  
[CLICKER 4 FOR STM32F4](#) [EASYMX PRO V7A FOR STM32](#) [CLICKER 4 FOR PIC18F](#) [Si8285\\_86v2-KIT](#) [PAC52700EVK1](#) [NCP-](#)  
[NCV51752D2PAK3LGEVB](#) [ISL81807EVAL1Z](#) [AP33772S-EVB](#) [EVALM7HVIGBTFCINV4TOBO1](#) [903-0300-000](#) [902-0173-000](#) [903-](#)  
[0301-000](#) [ROA1286023/1](#)