

# EVAL\_XDPP1100\_Q024\_DB user manual

## XDPP1100-Q024 daughter board

### About this document

#### Scope and purpose

This document explains the hardware features and serves as a user manual for the EVAL\_XDPP1100\_Q024\_DB daughter board, designed by Infineon Technologies. The **XDPP1100-Q024** belongs to Infineon's **XDPTM digital power controller family**, optimized to provide a high level of performance and design flexibility to DC-DC converters. This controller is designed to achieve high efficiency, system control, and cost savings for applications such as telecom, servers, data centers and computing isolated DC-DC solutions. The daughter board is used as a test and firmware (FW) development tool.

#### Intended audience

Power supply design engineers, system engineers, embedded power designers.

### Table of contents

<b>About this document</b> .....	<b>1</b>
<b>Table of contents</b> .....	<b>1</b>
<b>1 General description</b> .....	<b>2</b>
1.1 Daughter board overview .....	2
1.2 Jumper settings.....	3
1.3 Test points.....	4
1.4 LED indications .....	4
<b>2 Getting started</b> .....	<b>6</b>
2.1 Required equipment .....	6
2.2 GUI tool.....	6
2.2.1 System requirements .....	6
2.2.2 Installation .....	6
<b>3 Power-up procedure</b> .....	<b>7</b>
3.1 Force I <sup>2</sup> C connection .....	10
3.2 Telemetry update .....	10
3.3 Floating meter .....	11
<b>4 Schematic and bill of materials</b> .....	<b>12</b>
4.1 Schematic .....	12
4.2 Bill of materials.....	12
<b>Revision history</b> .....	<b>14</b>

General description

# 1 General description

The EVAL\_XDPP1100\_Q024\_DB daughter board is used for testing and programming the XDPP1100 VQFN 4 mm x 4 mm 24-pin version controller. An onboard I<sup>2</sup>C connector allows the user to interface with the XDPP1100 controller through Infineon’s graphical user interface (GUI) and a USB-to-I<sup>2</sup>C dongle. The GUI is available to users as a complimentary tool that can be downloaded from Infineon [Developer Center](#). Searching the product part number XDPP1100, the XDPP1100 GUI will show up for downloading.

The daughter board can be used as a standalone FW development tool, or used with a power board as a complete evaluation kit. This document describes the standalone version of the daughter board. User could order the daughter board (EVAL\_XDPP1100\_Q024\_DB), a 600 W full-bridge power stage (EVAL\_600W\_FBFB\_XDPP), and an USB dongle (USB007A) to make an evaluation kit as shown in [Figure 1](#).

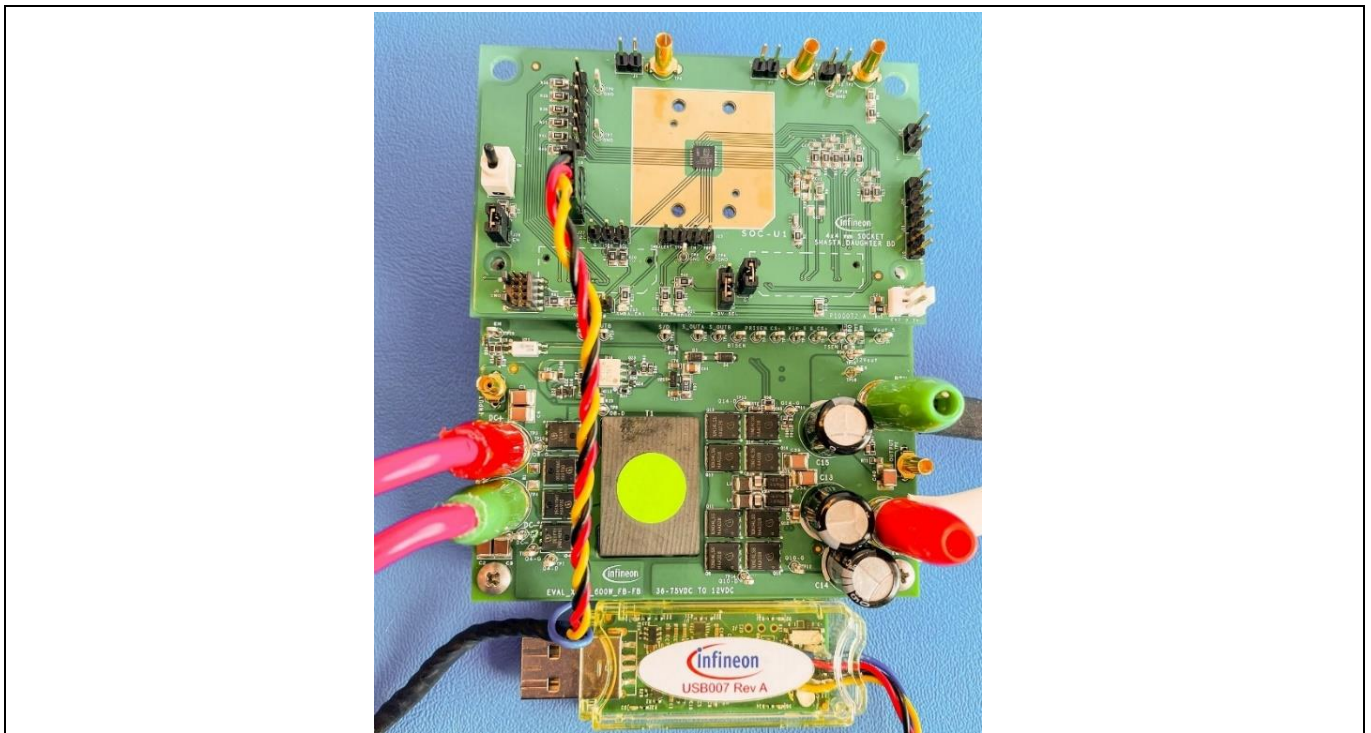

Figure 1 Evaluation kit

The daughter board uses board-to-board connectors (QTE-020-01-L-D-A) to interface control signals from the daughter board to a power board with compatible connectors (QSE-020-01-L-D-A) to establish a plug-in mechanism. This plug-in mechanism provides flexibility for evaluating XDPP1100 performance with any of its supported topologies.

The board also provides the capability to use an IC socket (24QHC50A74040G) for easy replacement of the XDPP1100-Q024 instead of soldering the device onto the PCB. The IC socket does not mounted on the board and need to be purchased separately.

## 1.1 Daughter board overview

The daughter board consists of the control circuitry such as analog filters for processing feedback signals from the power board, PWM outputs, digital inputs and outputs, I<sup>2</sup>C connector, Cortex® JTAG/SWD debug port, LED indicators and the XDPP1100-Q024 controller. It can be powered using external 3.3 V, or 3.3 V supply from the power board. The daughter board is shown in [Figure 2](#). The board-to-board rectangular header connectors are located on the bottom side of the PCB.

General description

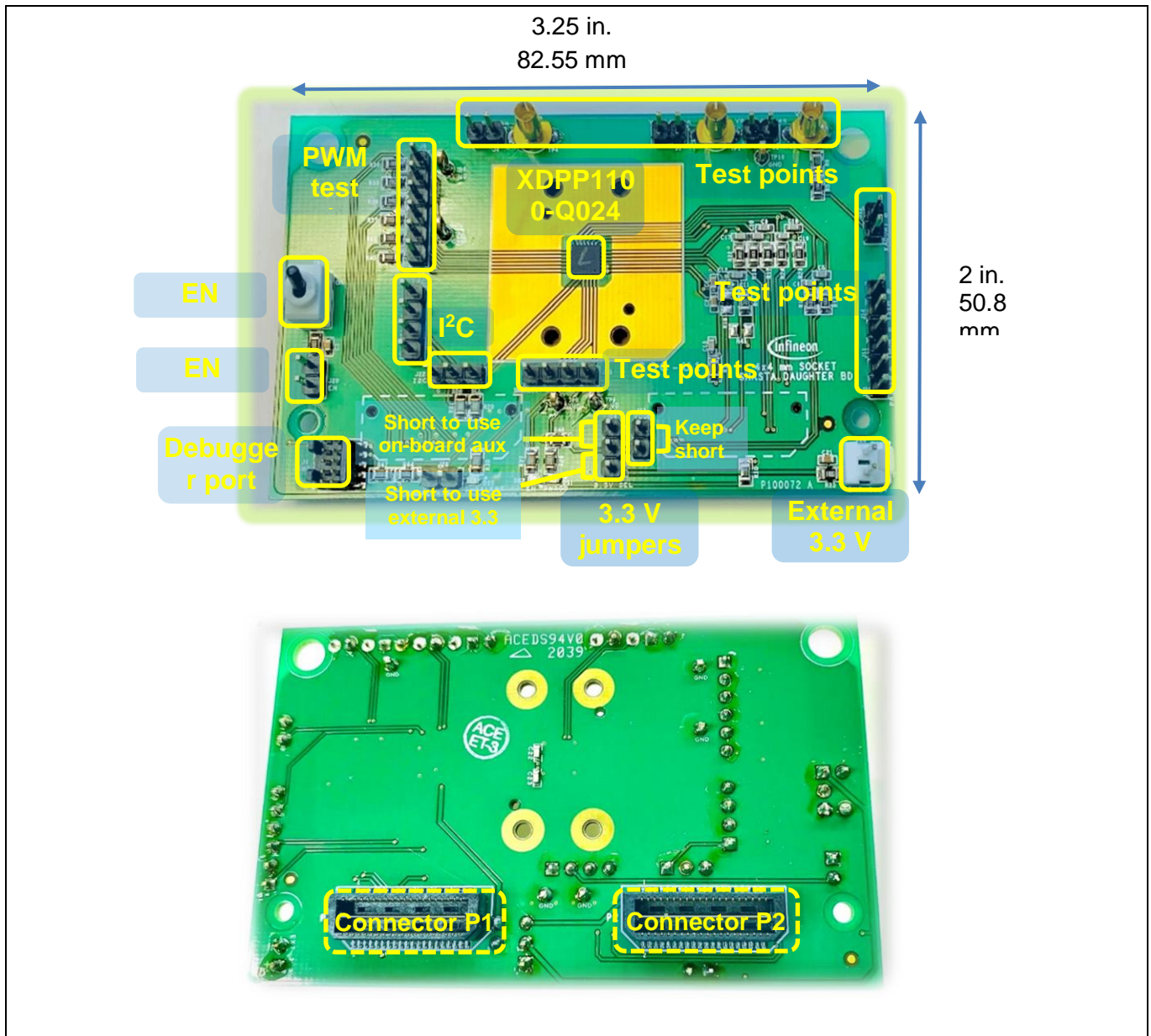

Figure 2 XDPP1100-Q024 daughter board

## 1.2 Jumper settings

Table 1 Daughter board jumper settings

Jumper	Description	Functionality
J23	External 3.3 V	This jumper is used to provide external 3.3 V supply to the daughter board. Connect an external power supply capable of 3.3 V and 0.1 A at this jumper, if external 3.3 V is selected using J24.
J24	3.3 V selector	This jumper is used to select between external 3.3 V and 3.3 V supply from the auxiliary supply of the power board. By default, external 3.3 V supply is selected, i.e., pins 1 and 2 are shorted.
J27	3.3 V jumper	This jumper is used to connect and disconnect 3.3 V supply to VDD of the IC. By default, this is always populated.
J28	SMBALERT jumper	This jumper connects the pull-up resistor to the SMBALERT pin.

General description

Jumper	Description	Functionality
J29	EN jumper	This jumper allows use of the enable switch SW1 to control the EN pin of the XDPP1100. The board is shipped with this jumper connected to enable use of the EN switch.

### 1.3 Test points

The EVAL\_XDPP1100\_Q024\_DB daughter board consists of test points for most of the XDPP1100 pins to allow measurement or monitoring of signals. These test points consist of analog signals, digital signals and PWM signals. **Figure 3** shows the physical location of various test points on the daughter board.

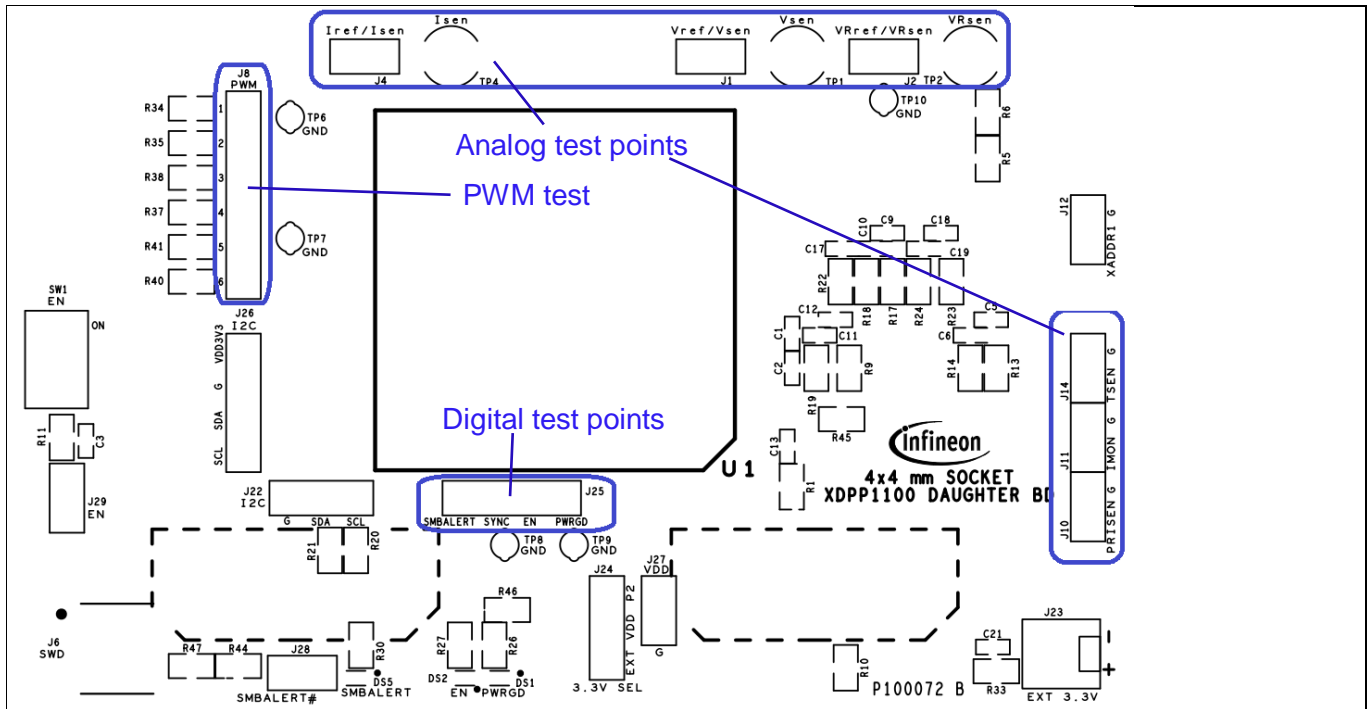

Figure 3 XDPP1100-Q024 test points

### 1.4 LED indications

**Table 2** shows the purpose of the available LEDs on the daughter board and **Figure 4** shows the location of these LEDs.

Table 2 LED indicators on the daughter board

LED	Color	Indications
EN (DS2)	Green	This LED indicates the logic level of the enable pin. The LED is on when the EN pin is high.
PWRGD (DS1)	Red	This LED indicates the health of loop 0 output voltage based on the thresholds configured through PMBus commands. During first-time 3.3 V power-up, this is on as it is pulled up to 3.3 V. Once the converter is enabled the status of this LED is determined by the level of output voltage and the polarity of the POWER_GOOD. The default logic is active low, but can be modified to active high by modifying the GPIO polarity (set to 2) in PMBus command FW_CONFIG_PMBUS.

**General description**

LED	Color	Indications
		When the configuration is programmed to active high: Output voltage greater than POWER_GOOD_ON, LED is on Output voltage less than POWER_GOOD_OFF, LED is off
SMBALERT (DS5)	Yellow	SMBALERT indicator. To enable the SMBALERT LED, J28 should be shorted.

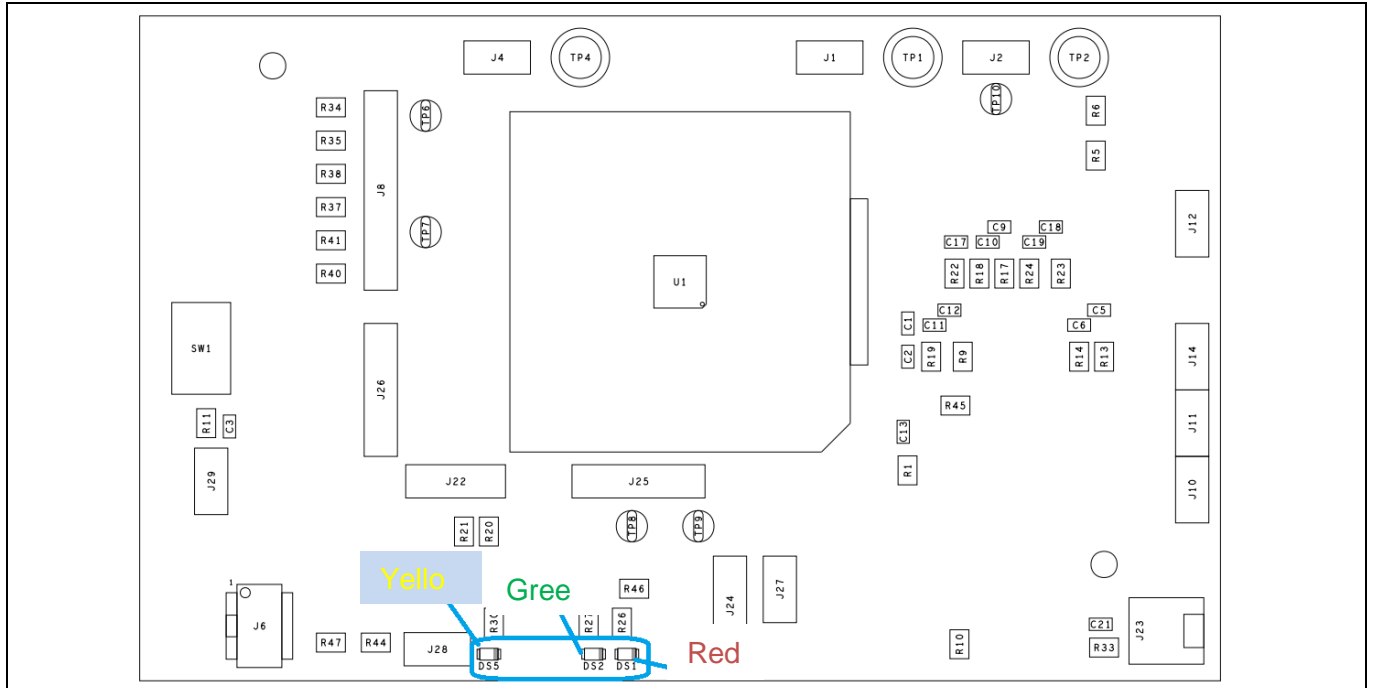

**Figure 4 LED indicators**



## Getting started

# 2 Getting started

## 2.1 Required equipment

- DC power supply that can provide 3.3 V and 100 mA current
- PC with Microsoft Windows 10 (32-bit or 64-bit)
- Oscilloscope with 500 MHz or above bandwidth (optional)
- Infineon USB-to-I<sup>2</sup>C dongle USB007 Rev A or B

## 2.2 GUI tool

Infineon provides a complimentary GUI software tool that allows users to configure and evaluate the XDPP1100-Q024 controller. Below are the key features of the GUI:

- Step-by-step design tools to configure the XDPP1100
- Fault status messages
- Telemetry reporting of  $V_{OUT}$ ,  $I_{OUT}$ ,  $V_{IN}$ ,  $P_{IN}$  and temperature
- Save and load design files
- Allows storing the configuration of PMBus and I<sup>2</sup>C registers into both RAM and OTP
- Allows storing of the FW patch into both RAM and OTP
- Linear11 format calculator tool

The sections below describe the requirements and procedures to operate and install the Infineon GUI.

### 2.2.1 System requirements

- 1) Ensure that the PC is connected to the internet.
- 2) Infineon's GUI tool requires installation of *Microsoft .Net Framework 4.0*. Use this link to download it: [.Net download](#).
- 3) For Windows 7 or 8, there may be a security warning while running this program – please make sure to continue to run the program.

### 2.2.2 Installation

Installing the GUI is the first step toward evaluating the XDPP1100. Download the installation package from the Infineon [software toolbox](#). **Do not connect** the USB-to-I<sup>2</sup>C dongle before the installation process is complete. When installing, recommend to install the XDPP1100 GUI to the default folder C:\Users\user\_name\Infineon\Tools\XDPP1100-GUI.

Refer to the [XDPP1100 GUI installation guide](#) for any additional information about GUI installation or troubleshooting issues related to dongle connection.

**Power-up procedure**

### 3 Power-up procedure

This section describes the power-up sequence for evaluating the XDPP1100-Q024 controller, once the GUI is installed.

- Connect an external 3.3 V DC power supply at J23, as shown below.

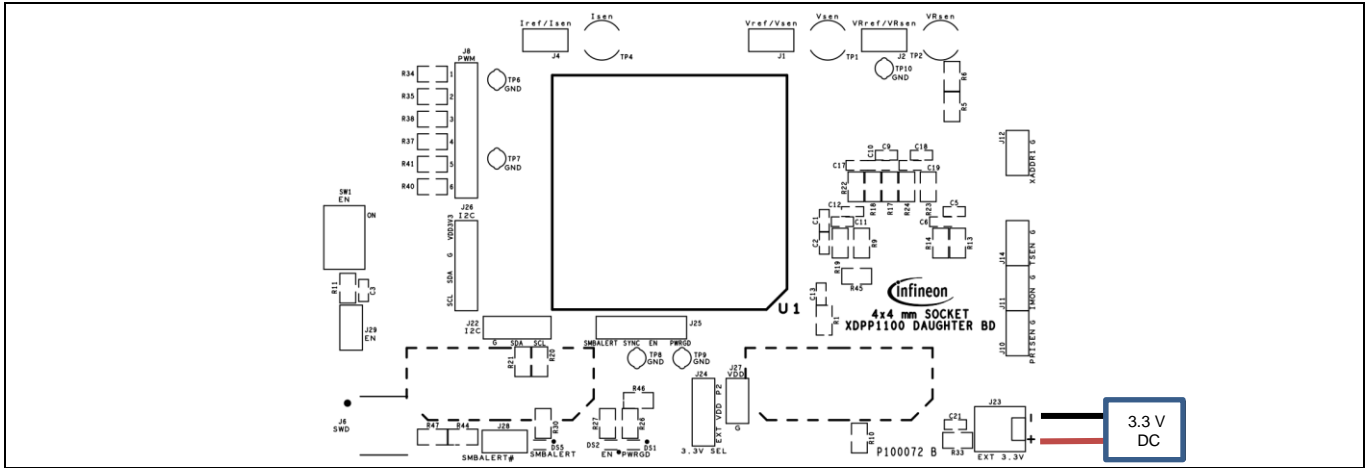

**Figure 5 External 3.3 V connection for the daughter board**

- Connect one end of the USB007 dongle at J26 as shown below by matching the color of the dongle wires to the signal names. The other end is connected to the USB port of the PC.
  - The blue wire of the USB007A1 dongle can be used for EN control. It should be connected to J29 pin2 if EN control through GUI is desired. If left floating, the EN control by GUI is not used.
  - The blue wire of the USB007B dongle should be connected to 3.3 V to bias the isolated dongle. When using the USB007B dongle, the EN control can be done via the onboard switch SW1 with jumper J29 shorted.

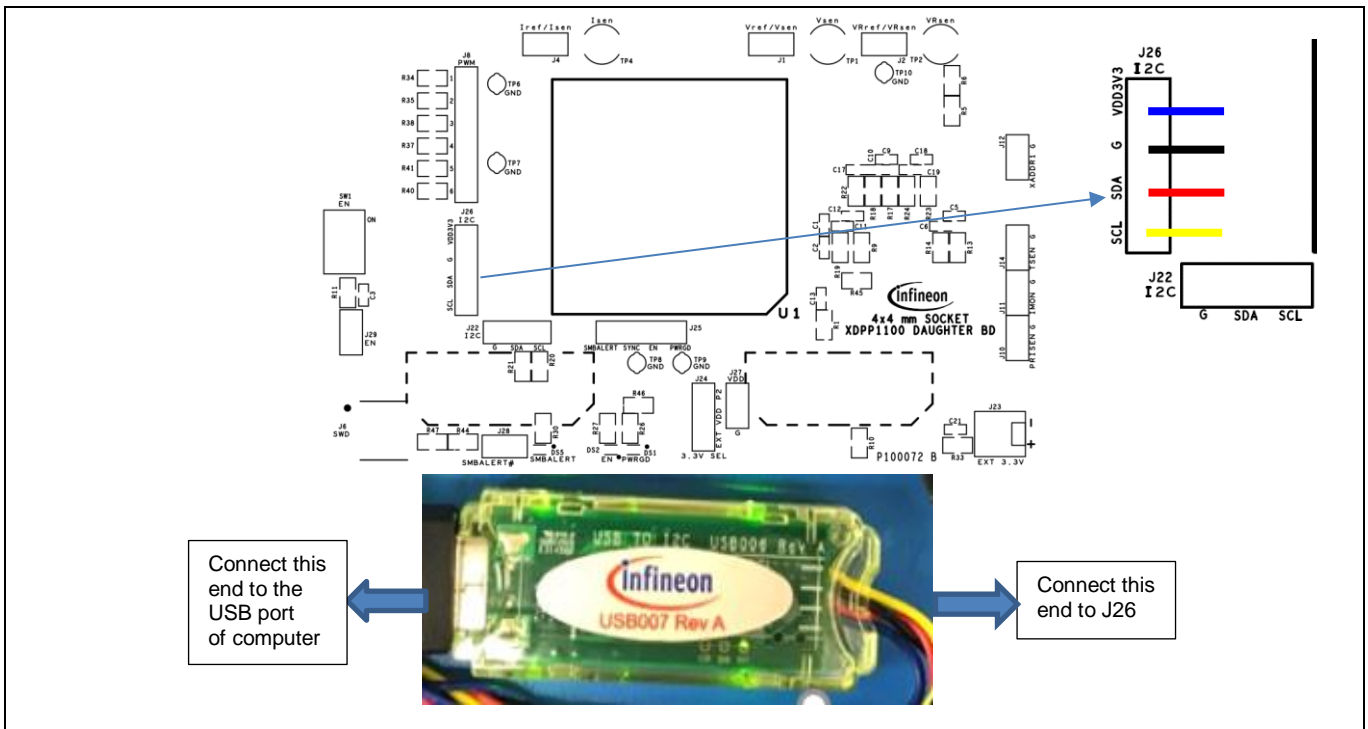

**Figure 6 USB-to-I<sup>2</sup>C dongle connection**

Power-up procedure

- Turn on the 3.3 V power supply. If the USB dongle is connected and the dongle driver is installed properly, the USB icon at the bottom left corner will turn green. The USB hardware (HW) model and dongle FW version would show in the information bar at the bottom. Also, update the dongle firmware using the icon as shown below.

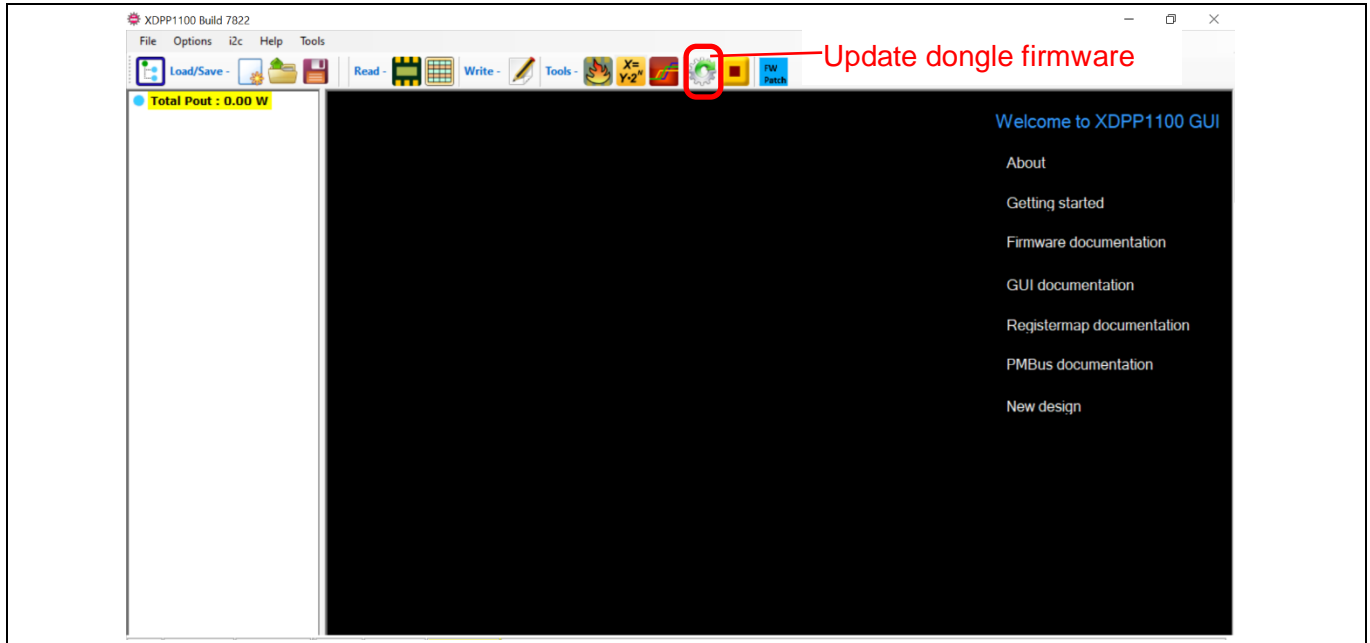

Figure 7 XDPP1100 GUI

- Use the auto-populate shortcut button to scan the device that is connected on the I<sup>2</sup>C bus. If the XDPP1100 is properly biased, the GUI should identify the device part number and its address offset, then add the device to the design. The GUI will read the stored program from the IC to the GUI. If the XDPP1100 is not pre-programmed (blank IC when it leaves the factory), the registers and PMBus command have the default values and most of them are zero.

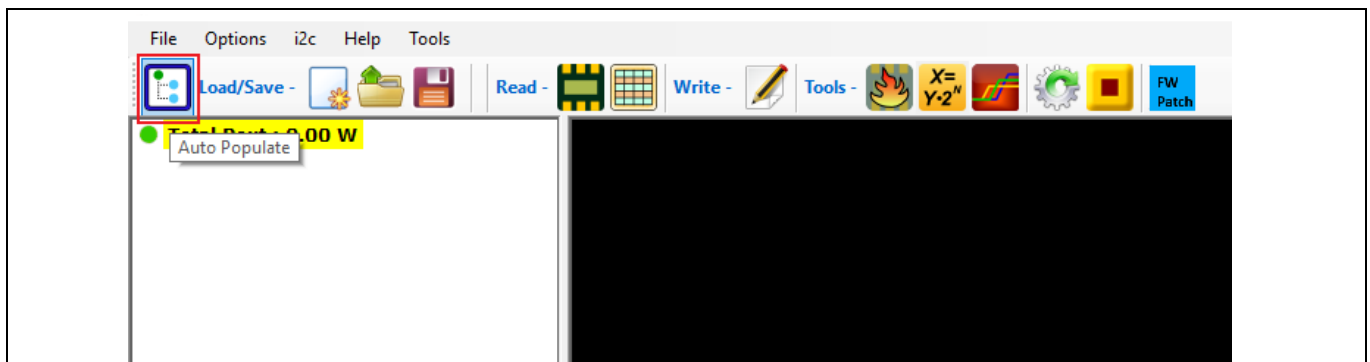
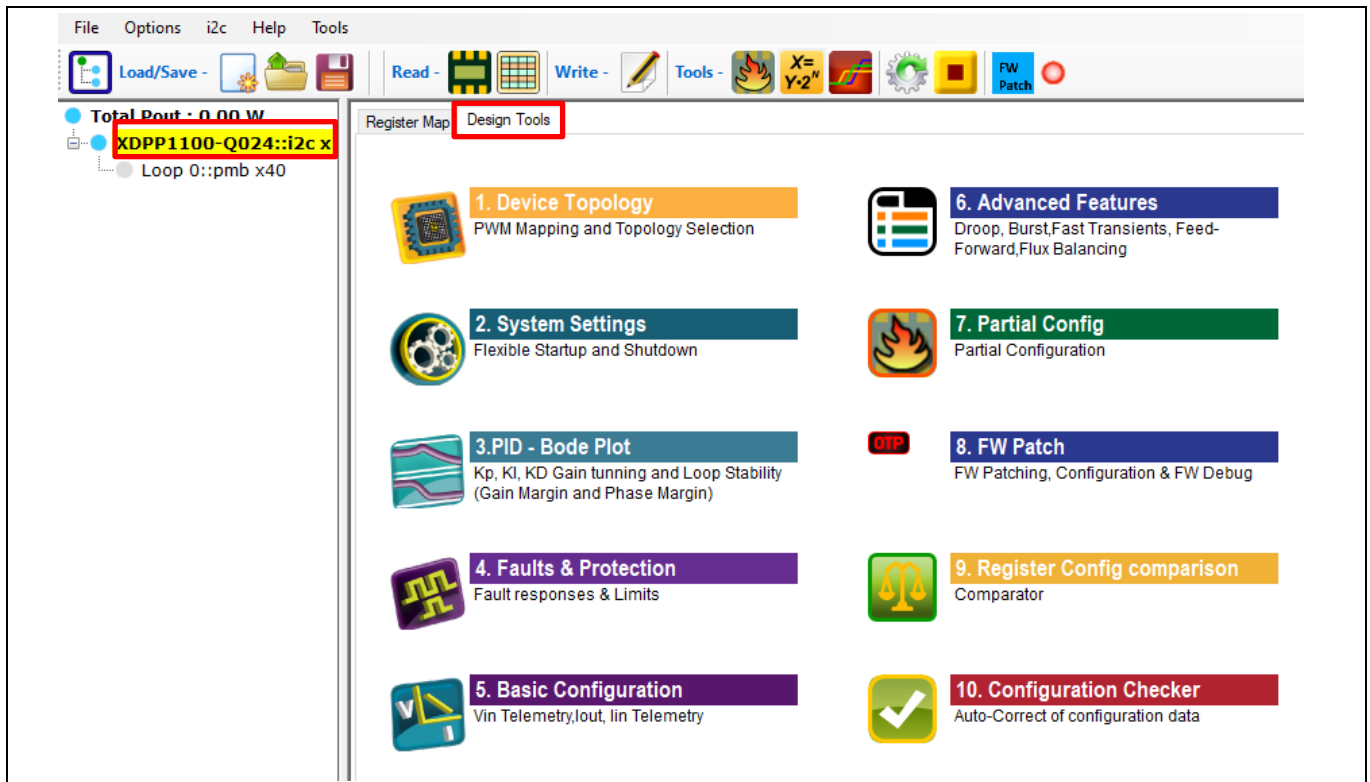

Figure 8 Auto-populate

- The user can use the GUI design tool to program the device per application requirements (Figure 9). All the configurations are in RAM. RAM is a volatile memory and can be used during the evaluation phase to try different configuration settings without limitation. The XDPP1100 has 32 kB RAM, and 10 kB is reserved for the user. It is recommended to take advantage of the 10 kB RAM to verify patch and configuration. Only the final configuration should be stored to device non-volatile memory which is one-time programmable (OTP). The XDPP1100 has 64 kB available OTP space for FW patch and configuration.



**Power-up procedure**



**Figure 9 GUI design tool**

- The configuration could be saved to a design file using the file “Save Board Design”, or using the shortcut “Save the design file”. It will save the register and PMBus configuration to a “.pcd” file.

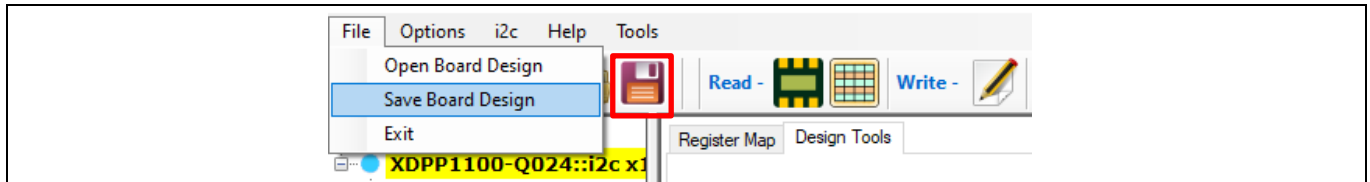

**Figure 10 Save configuration to design file**

- To re-load the design file to the device use “Open Board Design” as shown in **Figure 11** to open the “.pcd” file. The GUI will show a pop-up window (**Figure 12**). Click **Write to Device 0x10**. This will write the program into RAM of the IC.

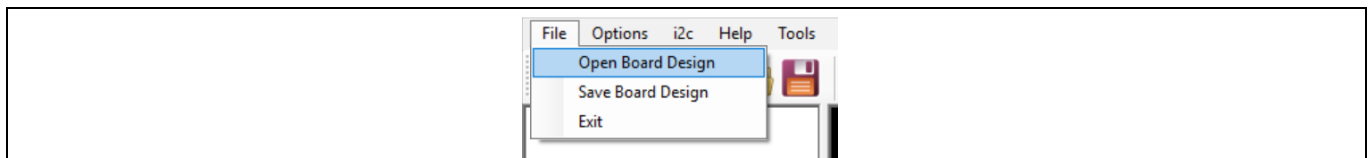

**Figure 11 Open design file**

Power-up procedure

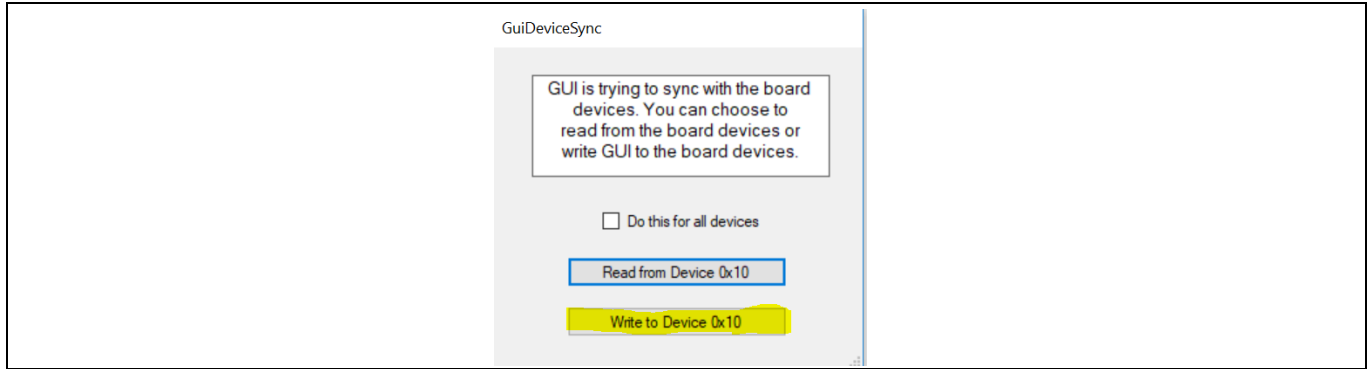

Figure 12 Write to device operation

- For more information about the GUI, refer to **Help** menu for additional documentation.

### 3.1 Force I<sup>2</sup>C connection

The auto-populate can add a device by detecting the product ID. The I<sup>2</sup>C communication automatically sets up after auto-populating. In some cases, configuring a device with unmatched product ID is desirable. In this case, the I<sup>2</sup>C communication could be force-enabled by checking **Force i2c/PMBus OK** in the Options menu (Figure 13).

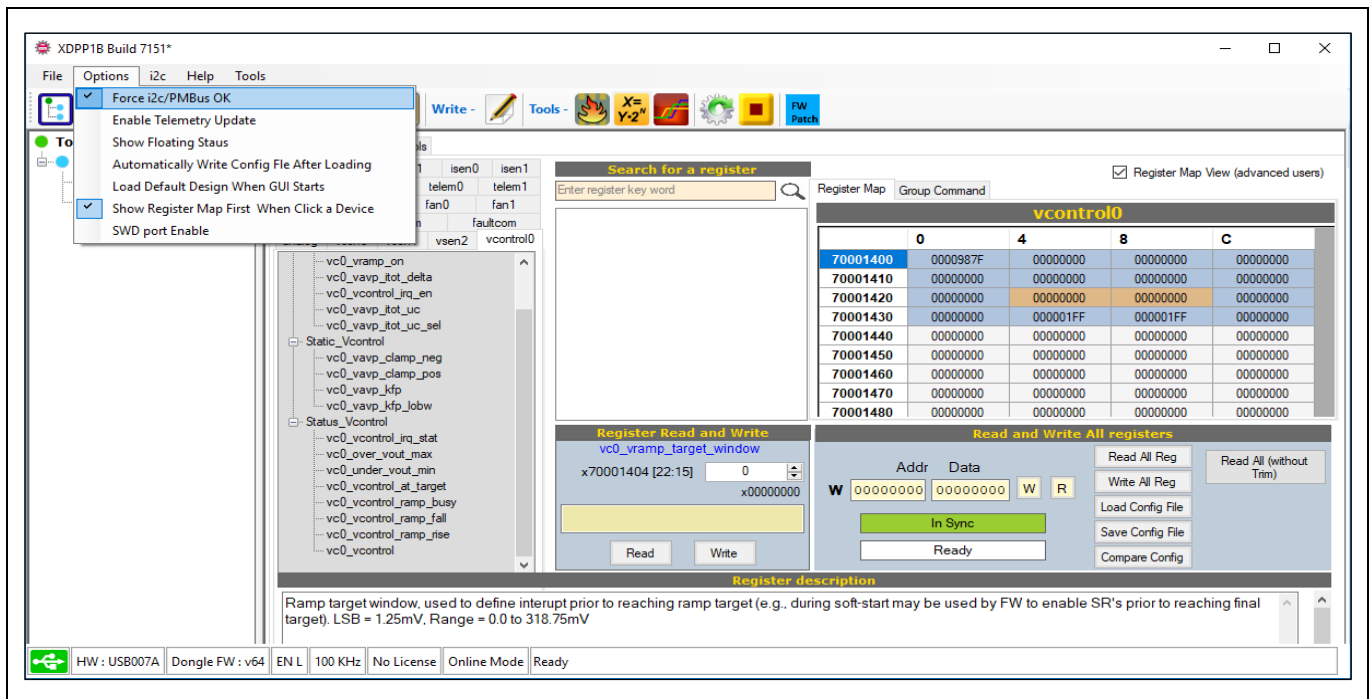

Figure 13 Force I<sup>2</sup>C/PMBus connection

### 3.2 Telemetry update

The **Status** tab in the GUI shows all the status commands such as STATUS\_WORD and STATUS\_VOUT. The user can click the **Read status** button to see the updated status, or select the **Enable Telemetry Update** option in the menu to have status and telemetry automatically updated every second.

Power-up procedure

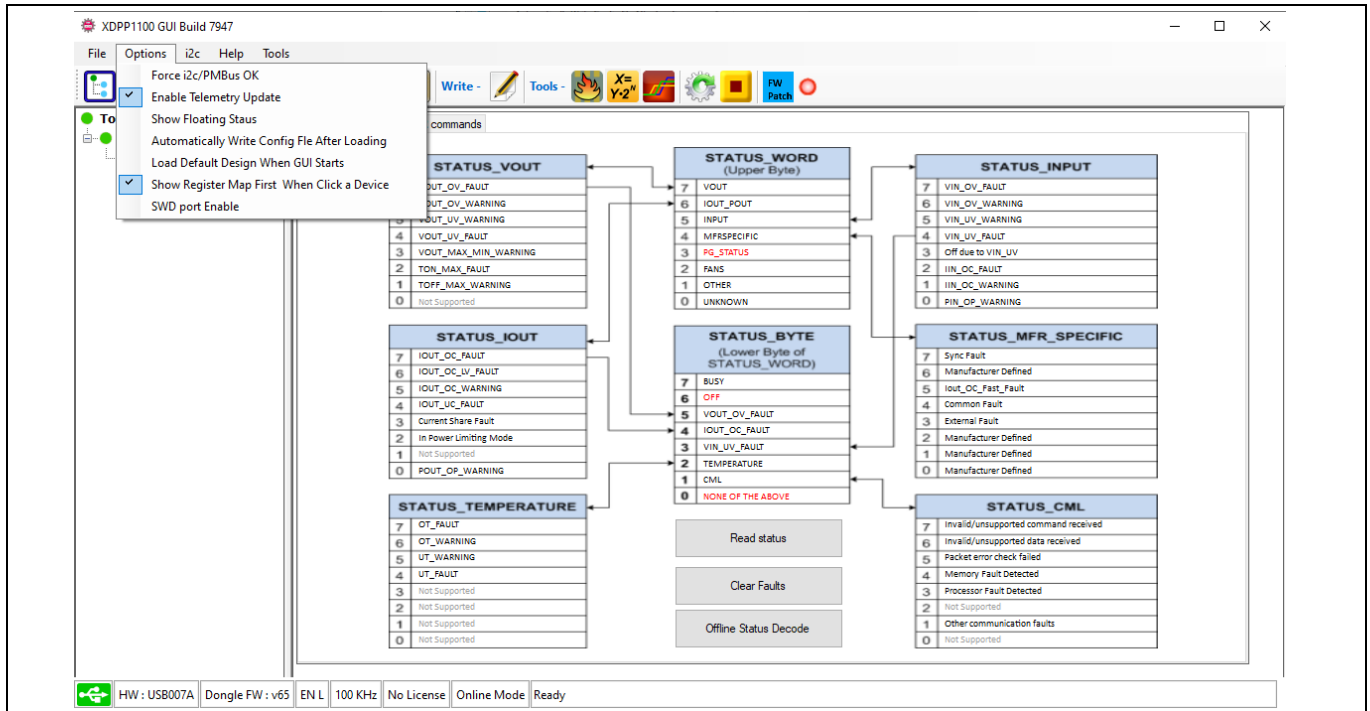

Figure 14 Enable Telemetry Update

### 3.3 Floating meter

The GUI offers a floating meter to monitor the key status of the converter, such as input voltage, output voltage, input current, output current, input power and temperature. The floating meter can be turned on by selecting **Show Floating Status** in the options menu. Once turned on, the information will be shown in a pop-up window. This window stays on screen even when the main GUI window is minimized.

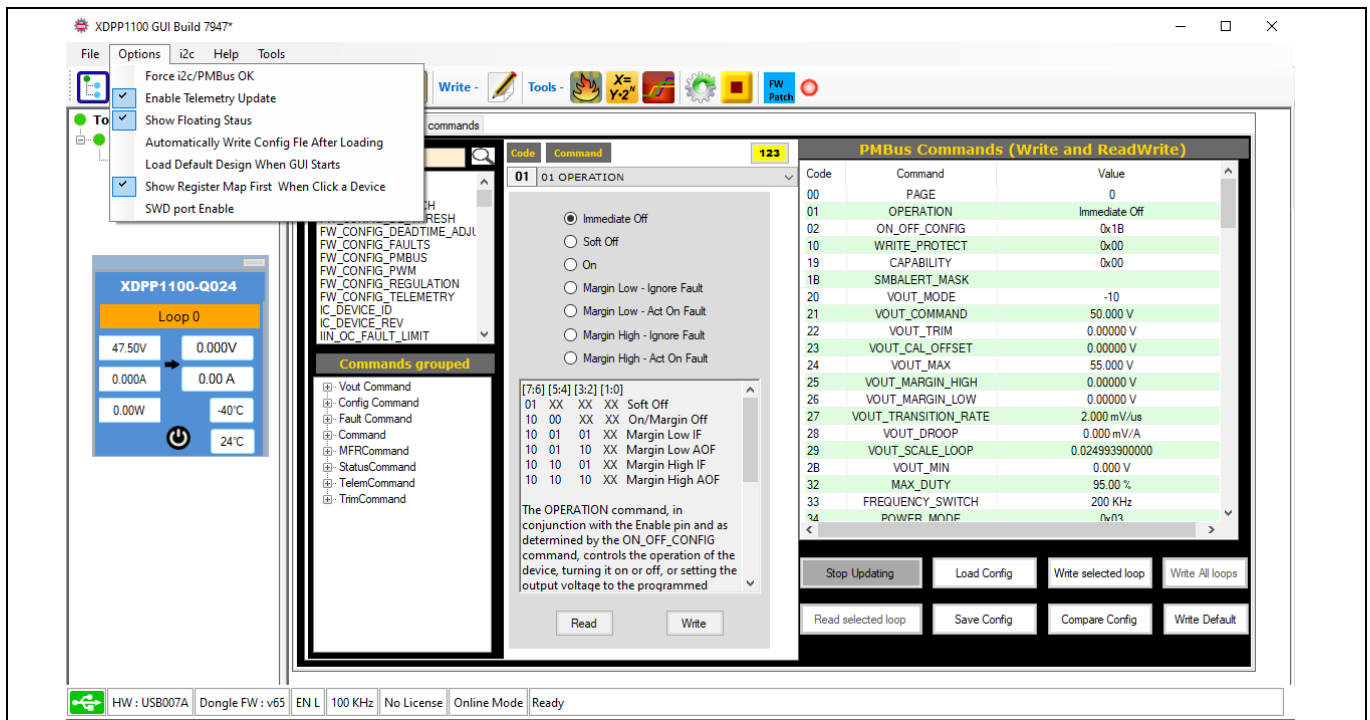

Figure 15 Show Floating Status

Schematic and bill of materials

## 4 Schematic and bill of materials

### 4.1 Schematic

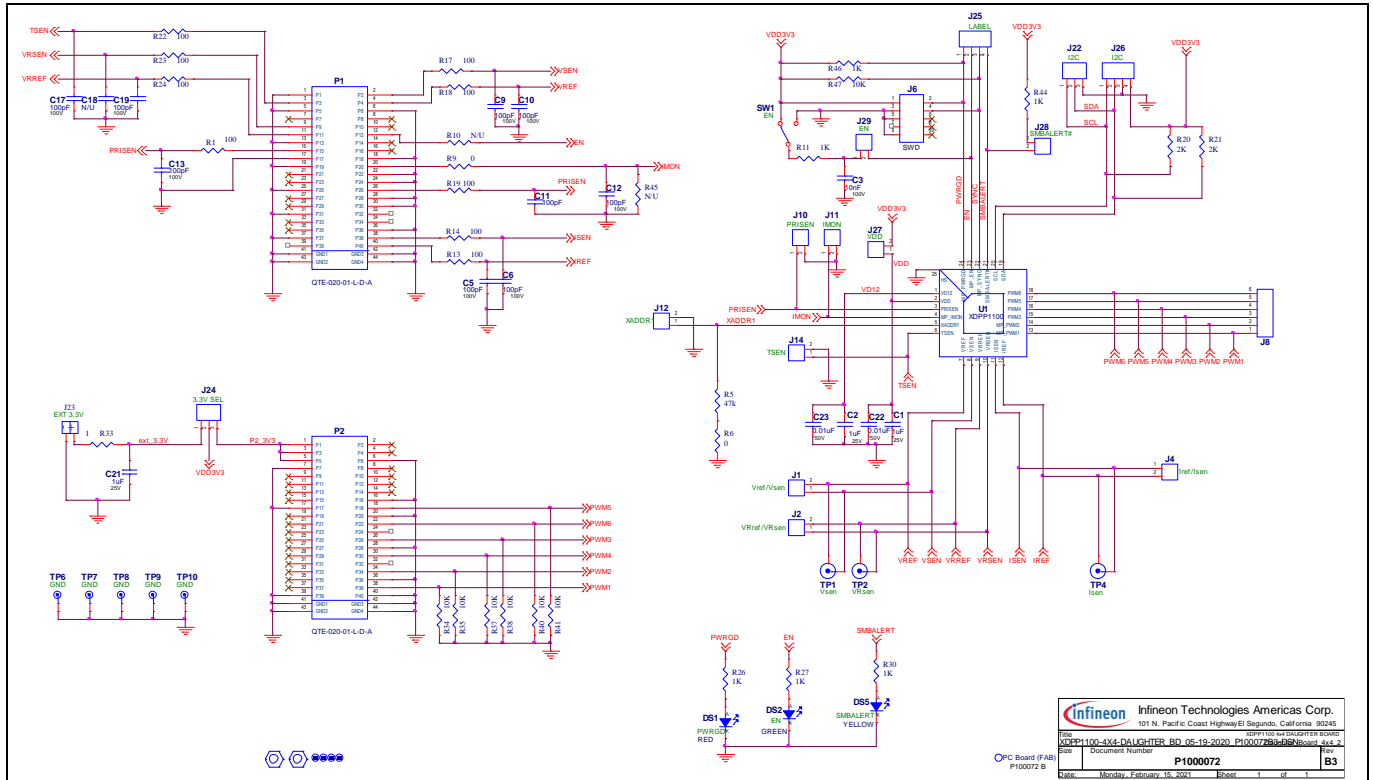

Figure 16 XDPP1100\_Q024 daughter board schematic

### 4.2 Bill of materials

Table 3 BOM for daughter board

Item	Qty.	Ref.	Manufacturer	Part number
1	1	BRD1		P100072 B3
2	3	C1, C2, C21	TDK	C1608X7R1E105K
3	1	C3	TDK	C1608C0G2A103J080AC
4	9	C5, C6, C9, C10, C11, C12, C13, C17, C18, C19	TDK	C1608C0G2A101K
5	1	C18	TDK	Not used
6	2	C22, C23	TDK	C1608X7R1H103K080
7	1	DS1	Würth	150060RS75000
8	1	DS2	Würth	150060GS75000
9	1	DS5	Würth	150060YS75000
10	10	J1, J2, J4, J10, J11, J12, J14, J27, J28, J29	Würth	613 002 111 21
11	1	J6	Samtec	FTSH-105-01-L-DV-007-K
12	1	J8	Würth	61300611121
13	2	J22, J24	Würth	613 003 111 21
14	1	J23	TE Connect	640456-2
15	2	J25, J26	Würth	613 004 111 21
16	2	M1, M2	Keystone	8833
17	2	P1, P2	Samtec	QTE-020-01-L-D-A
18	9	R1, R13, R14, R17, R18, R19, R22, R23, R24	Panasonic	ERJ-6ENF1000V

**Schematic and bill of materials**

<b>Item</b>	<b>Qty.</b>	<b>Ref.</b>	<b>Manufacturer</b>	<b>Part number</b>
19	1	R5	Panasonic	ERJ-6ENF4702V
20	2	R6, R9	Panasonic	ERJ-6GEY0R00V
21	6	R11, R26, R27, R30, R44, R46	Panasonic	ERJ-6ENF1001V
22	1	R10	Panasonic	Not Used
23	2	R20, R21	Panasonic	ERJ-6ENF2001V
24	1	R33	Panasonic	ERJ-6RQF1R0V
25	7	R34, R35, R37, R38, R40, R41, R47	Panasonic	ERJ-6ENF1002V
26	1	R45	Panasonic	ERJ-6ENF3001V
27	1	SW1	C&K	GT11MCBE
28	3	TP1, TP2, TP4	CINCH CON	129-0701-202
29	5	TP6, TP7, TP8, TP9, TP10	Keystone	5020
30	1	U1	Infineon	XDPP1100-Q024

[1] [XDPP1100 product page](#)

[2] [XDPP1100\\_GUI\\_installation\\_guide](#)

[3] [XDPP1100 application note](#)

Revision history

**Revision history**

Document version	Date of release	Description of changes
V 1.0	2022-03-19	Initial release
V 1.2	2023-08-10	Updated daughter board part number and GUI installation information



#### Trademarks

All referenced product or service names and trademarks are the property of their respective owners.

**Edition 2023-08-10**

**Published by  
Infineon Technologies AG  
81726 Munich, Germany**

**© 2023 Infineon Technologies AG.  
All Rights Reserved.**

**Do you have a question about this document?**

**Email: [erratum@infineon.com](mailto:erratum@infineon.com)**

**Document reference  
UM\_2108\_PL88\_2109\_202356**

#### IMPORTANT NOTICE

The information contained in this application note is given as a hint for the implementation of the product only and shall in no event be regarded as a description or warranty of a certain functionality, condition or quality of the product. Before implementation of the product, the recipient of this application note must verify any function and other technical information given herein in the real application. Infineon Technologies hereby disclaims any and all warranties and liabilities of any kind (including without limitation warranties of non-infringement of intellectual property rights of any third party) with respect to any and all information given in this application note.

The data contained in this document is exclusively intended for technically trained staff. It is the responsibility of customer's technical departments to evaluate the suitability of the product for the intended application and the completeness of the product information given in this document with respect to such application.

For further information on the product, technology, delivery terms and conditions and prices please contact your nearest Infineon Technologies office ([www.infineon.com](http://www.infineon.com)).

#### WARNINGS

Due to technical requirements products may contain dangerous substances. For information on the types in question please contact your nearest Infineon Technologies office.

Except as otherwise explicitly approved by Infineon Technologies in a written document signed by authorized representatives of Infineon Technologies, Infineon Technologies' products may not be used in any applications where a failure of the product or any consequences of the use thereof can reasonably be expected to result in personal injury.

## X-ON Electronics

Largest Supplier of Electrical and Electronic Components

*Click to view similar products for [Power Management IC Development Tools](#) category:*

*Click to view products by [Infineon](#) manufacturer:*

Other Similar products are found below :

[EVB-EP5348UI](#) [BQ25010EVM](#) [ISL80019AEVAL1Z](#) [ISLUSBI2CKIT1Z](#) [ISL8002AEVAL1Z](#) [ISL91108IIA-EVZ](#) [MAX8556EVKIT](#)  
[MAX15005AEVKIT+](#) [ISL28022EVKIT1Z](#) [STEVAL-ISA008V1](#) [DRI0043](#) [KITPF8100FRDMEVM](#) [EVB-EN6337QA](#)  
[SAMPLEBOXILD8150TOBO1](#) [MAX18066EVKIT#](#) [AP62300WU-EVM](#) [KITA2GTC387MOTORCTRTOBO1](#) [AEK-MOT-TK200G1](#)  
[EVLONE65W](#) [STEVAL-ILH006V1](#) [STEVAL-IPE008V2](#) [STEVAL-IPP001V2](#) [STEVAL-ISA013V1](#) [STEVAL-ISA067V1](#) [STEVAL-](#)  
[ISQ002V1](#) [TPS2306EVM-001](#) [TPS2330EVM-185](#) [TPS40001EVM-001](#) [SECO-HVDCDC1362-15W-GEVB](#) [BTS7030-2EPA](#)  
[LT8638SJV#WPBF](#) [LTC3308AIV#WTRPBF](#) [TLT807B0EPV](#) [BTS71033-6ESA](#) [EV13N91A](#) [EASYPIC V8 OVER USB-C](#) [EV55W64A](#)  
[CLICKER 4 FOR STM32F4](#) [EASYMX PRO V7A FOR STM32](#) [CLICKER 4 FOR PIC18F](#) [Si8285\\_86v2-KIT](#) [PAC52700EVK1](#) [NCP-](#)  
[NCV51752D2PAK3LGEVB](#) [ISL81807EVAL1Z](#) [AP33772S-EVB](#) [EVALM7HVIGBTFCINV4TOBO1](#) [903-0300-000](#) [902-0173-000](#) [903-](#)  
[0301-000](#) [ROA1286023/1](#)