

Preliminary datasheet

62 mm C-Series module with CoolSiC™ Trench MOSFET and pre-applied thermal interface material

Features

- Electrical features
 - $V_{DSS} = 1200\text{ V}$
 - $I_{DN} = 420\text{ A} / I_{DRM} = 840\text{ A}$
 - High current density
 - Low switching losses
- Mechanical features
 - 4 kV AC 1 min insulation
 - Pre-applied thermal interface material



Potential applications

- UPS systems
- Solar applications
- DC/DC converter
- High-frequency switching application
- Energy storage systems
- DC charger for EV

Product validation

- Qualified for industrial applications according to the relevant tests of IEC 60747, 60749 and 60068

Description

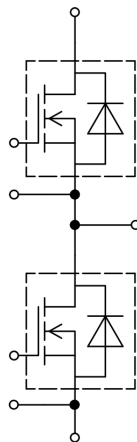

Table of contents

	Description	1
	Features	1
	Potential applications	1
	Product validation	1
	Table of contents	2
1	Package	3
2	MOSFET	3
3	Body diode (MOSFET)	6
4	Characteristics diagrams	7
5	Circuit diagram	12
6	Package outlines	13
7	Module label code	14
	Revision history	15
	Disclaimer	16

1 Package

Table 1 Insulation coordination

Parameter	Symbol	Note or test condition	Values	Unit
Isolation test voltage	V_{ISOL}	RMS, $f = 50 \text{ Hz}$, $t = 60 \text{ s}$	4.0	kV
Material of module baseplate			Cu	
Internal isolation		basic insulation (class 1, IEC 61140)	Al_2O_3	
Creepage distance	d_{Creep}	terminal to heatsink	29.0	mm
Creepage distance	d_{Creep}	terminal to terminal	23.0	mm
Clearance	d_{Clear}	terminal to heatsink	23.0	mm
Clearance	d_{Clear}	terminal to terminal	11.0	mm
Comparative tracking index	CTI		> 400	
Relative thermal index (electrical)	RTI	housing	140	°C

Table 2 Characteristic values

Parameter	Symbol	Note or test condition	Values			Unit
			Min.	Typ.	Max.	
Stray inductance module	L_{sCE}			20		nH
Module lead resistance, terminals - chip	$R_{CC'+EE'}$	$T_H = 25 \text{ °C}$, per switch		0.475		mΩ
Storage temperature	T_{stg}		-40		125	°C
Maximum baseplate operation temperature	T_{BPmax}				125	°C
Mounting torque for module mounting	M	- Mounting according to valid application note	M6, Screw	3	6	Nm
Terminal connection torque	M	- Mounting according to valid application note	M6, Screw	2.5	5	Nm
Weight	G			340		g

Note: Storage and shipment of modules with TIM => see AN2012-07.

2 MOSFET

Table 3 Maximum rated values

Parameter	Symbol	Note or test condition	Values	Unit
Drain-source voltage	V_{DSS}	$T_{vj} = 25 \text{ °C}$	1200	V
Implemented drain current	I_{DN}		420	A

(table continues...)

Table 3 (continued) Maximum rated values

Parameter	Symbol	Note or test condition	Values	Unit
Continuous DC drain current	I_{DDC}	$T_{\text{vj}} = 175\text{ °C}$, $V_{\text{GS}} = 18\text{ V}$ $T_{\text{H}} = 65\text{ °C}$	350	A
Repetitive peak drain current	I_{DRM}	verified by design, t_{p} limited by T_{vjmax}	840	A
Gate-source voltage, max. transient voltage	V_{GS}	$D < 0.01$	-10/23	V
Gate-source voltage, max. static voltage	V_{GS}		-7/20	V

Table 4 Recommended values

Parameter	Symbol	Note or test condition	Values	Unit
On-state gate voltage	$V_{\text{GS(on)}}$		15...18	V
Off-state gate voltage	$V_{\text{GS(off)}}$		-5...0	V

Table 5 Characteristic values

Parameter	Symbol	Note or test condition	Values			Unit
			Min.	Typ.	Max.	
Drain-source on-resistance	$R_{\text{DS(on)}}$	$I_{\text{D}} = 420\text{ A}$	$V_{\text{GS}} = 18\text{ V}$, $T_{\text{vj}} = 25\text{ °C}$	1.96		mΩ
			$V_{\text{GS}} = 18\text{ V}$, $T_{\text{vj}} = 125\text{ °C}$	3.17		
			$V_{\text{GS}} = 18\text{ V}$, $T_{\text{vj}} = 175\text{ °C}$	4.21		
			$V_{\text{GS}} = 15\text{ V}$, $T_{\text{vj}} = 25\text{ °C}$	2.36		
Gate threshold voltage	$V_{\text{GS(th)}}$	$I_{\text{D}} = 168\text{ mA}$, $V_{\text{DS}} = V_{\text{GS}}$, $T_{\text{vj}} = 25\text{ °C}$, (tested after 1ms pulse at $V_{\text{GS}} = +20\text{ V}$)	3.45	4.3	5.15	V
Total gate charge	Q_{G}	$V_{\text{DD}} = 800\text{ V}$, $V_{\text{GS}} = -3/18\text{ V}$		1.2		μC
Internal gate resistor	R_{Gint}	$T_{\text{vj}} = 25\text{ °C}$		1.3		Ω
Input capacitance	C_{ISS}	$f = 100\text{ kHz}$, $V_{\text{DS}} = 800\text{ V}$, $V_{\text{GS}} = 0\text{ V}$ $T_{\text{vj}} = 25\text{ °C}$		36.3		nF
Output capacitance	C_{OSS}	$f = 100\text{ kHz}$, $V_{\text{DS}} = 800\text{ V}$, $V_{\text{GS}} = 0\text{ V}$ $T_{\text{vj}} = 25\text{ °C}$		1.8		nF
Reverse transfer capacitance	C_{rSS}	$f = 100\text{ kHz}$, $V_{\text{DS}} = 800\text{ V}$, $V_{\text{GS}} = 0\text{ V}$ $T_{\text{vj}} = 25\text{ °C}$		0.118		nF
C_{OSS} stored energy	E_{OSS}	$V_{\text{DS}} = 800\text{ V}$, $V_{\text{GS}} = -3/18\text{ V}$, $T_{\text{vj}} = 25\text{ °C}$		709		μJ
Drain-source leakage current	I_{DSS}	$V_{\text{DS}} = 1200\text{ V}$, $V_{\text{GS}} = -3\text{ V}$ $T_{\text{vj}} = 25\text{ °C}$		0.24	527	μA

(table continues...)

Table 5 (continued) Characteristic values

Parameter	Symbol	Note or test condition	Values			Unit
			Min.	Typ.	Max.	
Gate-source leakage current	I_{GSS}	$V_{DS} = 0\text{ V}$, $T_{vj} = 25\text{ °C}$ $V_{GS} = 20\text{ V}$			400	nA
Turn-on delay time (inductive load)	$t_{d\ on}$	$I_D = 420\text{ A}$, $R_{Gon} = 4.7\ \Omega$, $V_{DD} = 600\text{ V}$, $V_{GS} = -3/18\text{ V}$	$T_{vj} = 25\text{ °C}$	143		ns
			$T_{vj} = 125\text{ °C}$	132		
			$T_{vj} = 175\text{ °C}$	130		
Rise time (inductive load)	t_r	$I_D = 420\text{ A}$, $R_{Gon} = 4.7\ \Omega$, $V_{DD} = 600\text{ V}$, $V_{GS} = -3/18\text{ V}$	$T_{vj} = 25\text{ °C}$	153		ns
			$T_{vj} = 125\text{ °C}$	142		
			$T_{vj} = 175\text{ °C}$	127		
Turn-off delay time (inductive load)	$t_{d\ off}$	$I_D = 420\text{ A}$, $R_{Goff} = 1.5\ \Omega$, $V_{DD} = 600\text{ V}$, $V_{GS} = -3/18\text{ V}$	$T_{vj} = 25\text{ °C}$	150		ns
			$T_{vj} = 125\text{ °C}$	162		
			$T_{vj} = 175\text{ °C}$	169		
Fall time (inductive load)	t_f	$I_D = 420\text{ A}$, $R_{Goff} = 1.5\ \Omega$, $V_{DD} = 600\text{ V}$, $V_{GS} = -3/18\text{ V}$	$T_{vj} = 25\text{ °C}$	33		ns
			$T_{vj} = 125\text{ °C}$	33		
			$T_{vj} = 175\text{ °C}$	34		
Turn-on energy loss per pulse	E_{on}	$I_D = 420\text{ A}$, $V_{DD} = 600\text{ V}$, $L_\sigma = 10\text{ nH}$, $V_{GS} = -3/18\text{ V}$, $R_{Gon} = 4.7\ \Omega$, $di/dt = 5.2\text{ kA}/\mu\text{s}$ ($T_{vj} = 175\text{ °C}$)	$T_{vj} = 25\text{ °C}$	17.2		mJ
			$T_{vj} = 125\text{ °C}$	16.8		
			$T_{vj} = 175\text{ °C}$	17.2		
Turn-off energy loss per pulse	E_{off}	$I_D = 420\text{ A}$, $V_{DD} = 600\text{ V}$, $L_\sigma = 10\text{ nH}$, $V_{GS} = -3/18\text{ V}$, $R_{Goff} = 1.5\ \Omega$, $dv/dt = 14.2\text{ kV}/\mu\text{s}$ ($T_{vj} = 175\text{ °C}$)	$T_{vj} = 25\text{ °C}$	7.5		mJ
			$T_{vj} = 125\text{ °C}$	8		
			$T_{vj} = 175\text{ °C}$	8.4		
Thermal resistance, junction to heat sink	R_{thJH}	per MOSFET, Valid with IFX pre-applied Thermal Interface Material			0.14	K/W
Temperature under switching conditions	$T_{vj\ op}$		-40		175	°C

Note: The selection of positive and negative gate-source voltages impacts losses and the long-term behavior of the MOSFET and body diode. The design guidelines described in Application Notes AN 2018-09 and AN 2021-13 must be considered to ensure sound operation of the device over the planned lifetime.

$T_{vj,op} > 150\text{ °C}$ is allowed for operation at overload conditions for MOSFET and body diode. For detailed specifications, please refer to AN 2021-13.

3 Body diode (MOSFET)

Table 6 Maximum rated values

Parameter	Symbol	Note or test condition	Values	Unit
DC body diode forward current	I_{SD}	$T_{vj} = 175\text{ °C}$, $V_{GS} = -3\text{ V}$ $T_H = 65\text{ °C}$	190	A

Table 7 Characteristic values

Parameter	Symbol	Note or test condition	Values			Unit	
			Min.	Typ.	Max.		
Forward voltage	V_{SD}	$I_{SD} = 420\text{ A}$, $V_{GS} = -3\text{ V}$	$T_{vj} = 25\text{ °C}$		4.22	5.59	V
			$T_{vj} = 125\text{ °C}$		3.95		
			$T_{vj} = 175\text{ °C}$		3.85		

4 Characteristics diagrams

Output characteristic (typical), MOSFET

$I_D = f(V_{DS})$
 $V_{GS} = 18\text{ V}$

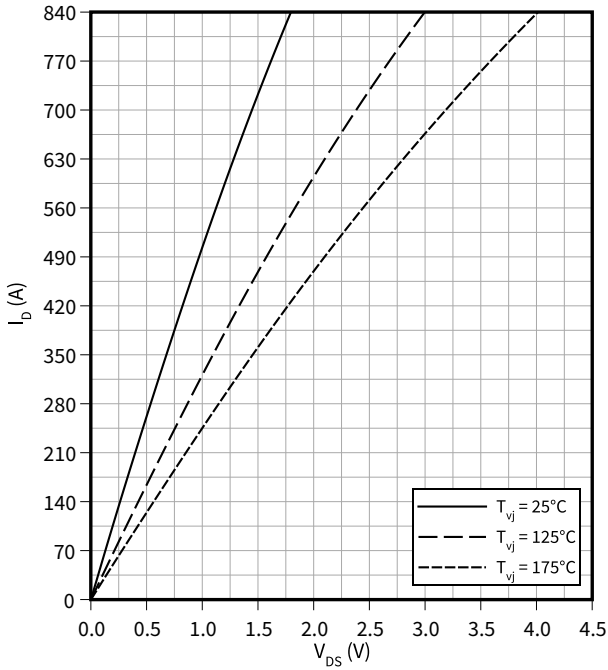

Output characteristic (typical), MOSFET

$I_D = f(V_{DS})$
 $V_{GS} = 15\text{ V}$

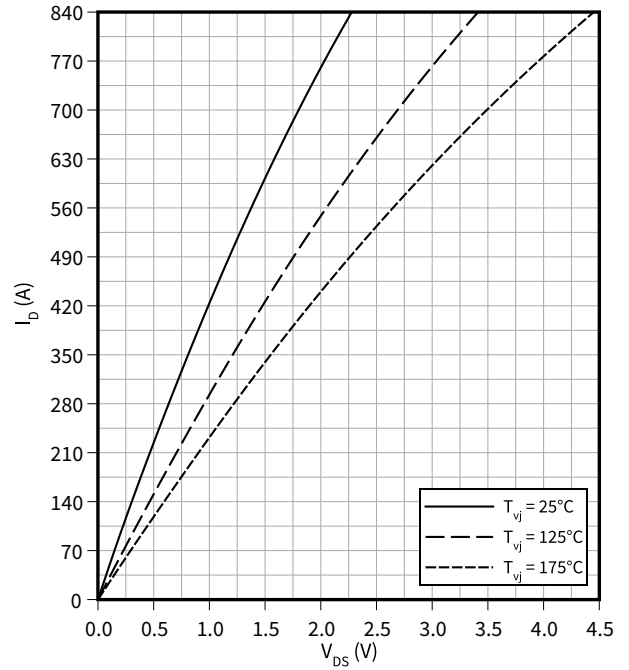

Drain source on-resistance (typical), MOSFET

$R_{DS(on)} = f(I_D)$
 $V_{GS} = 18\text{ V}$

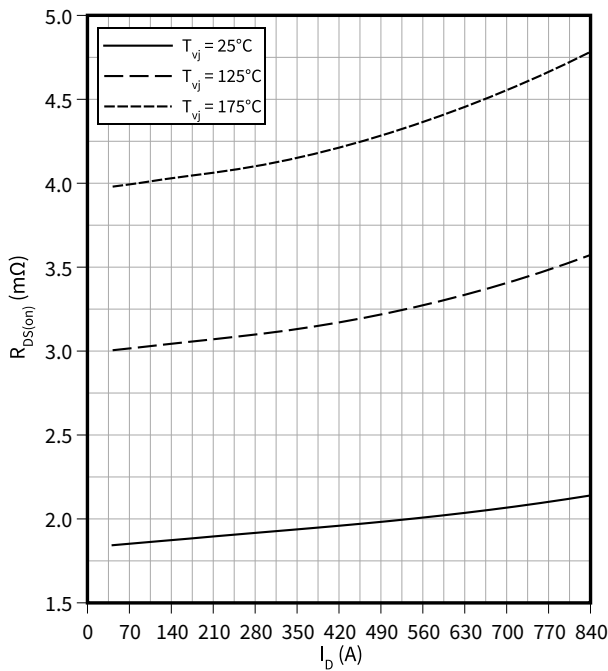

Drain source on-resistance (typical), MOSFET

$R_{DS(on)} = f(T_{vj})$
 $I_D = 420\text{ A}$

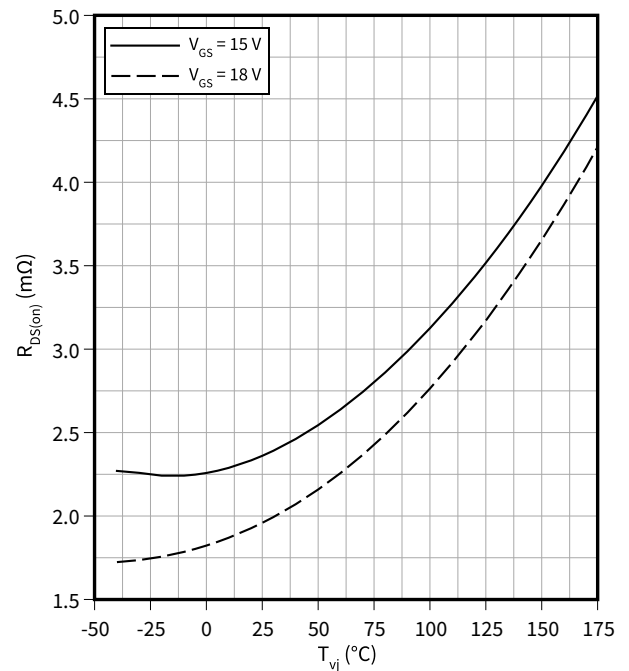

4 Characteristics diagrams

Output characteristic field (typical), MOSFET

$I_D = f(V_{DS})$
 $T_{vj} = 175\text{ °C}$

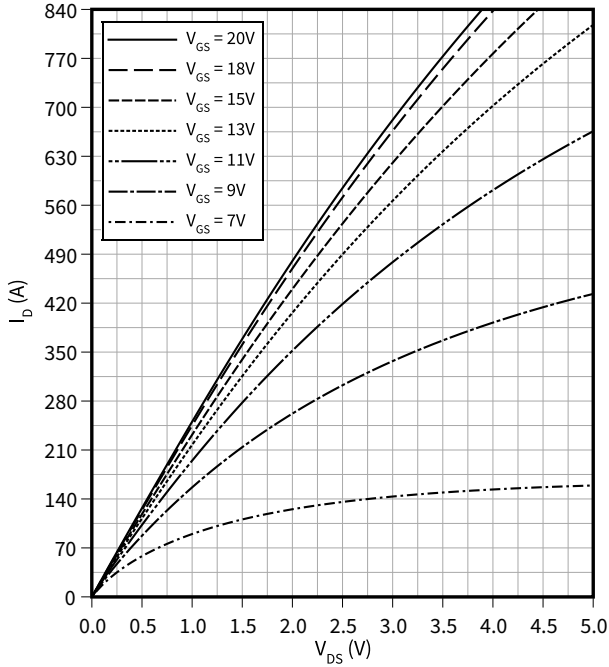

Transfer characteristic (typical), MOSFET

$I_D = f(V_{GS})$
 $V_{DS} = 20\text{ V}$

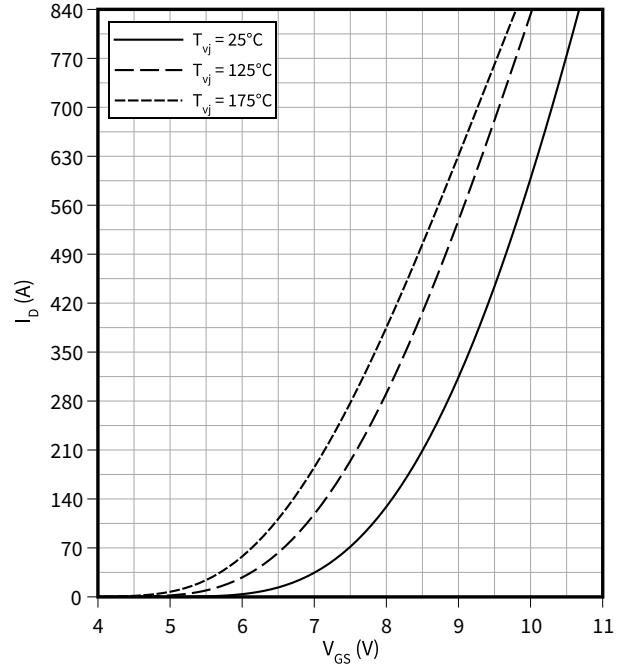

Gate-source threshold voltage (typical), MOSFET

$V_{GS(th)} = f(T_{vj})$
 $V_{GS} = V_{DS}$

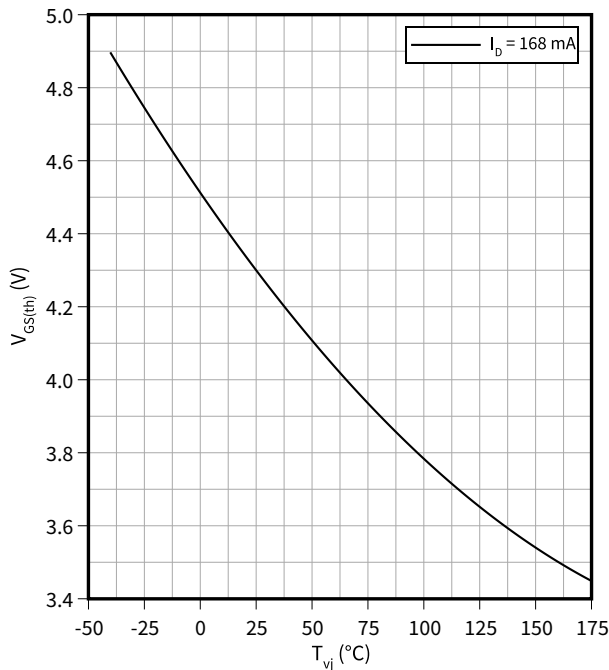

Gate charge characteristic (typical), MOSFET

$V_{GS} = f(Q_G)$
 $I_D = 420\text{ A}, T_{vj} = 25\text{ °C}$

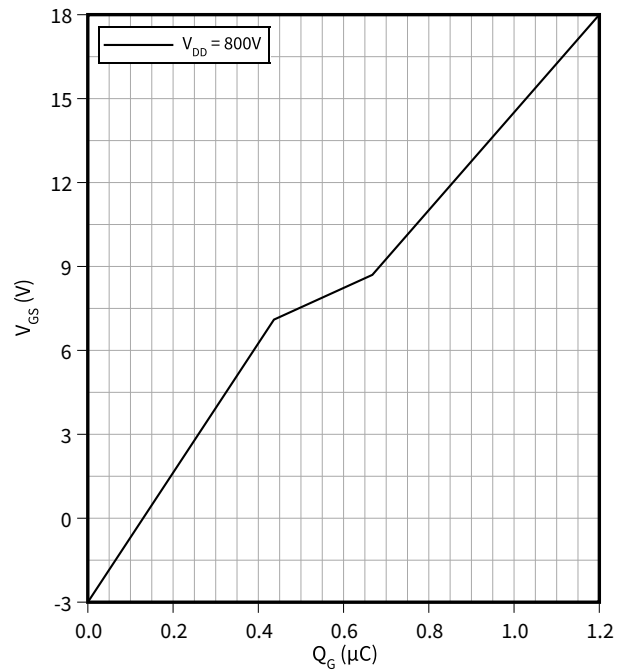

4 Characteristics diagrams

Capacity characteristic (typical), MOSFET

$C = f(V_{DS})$
 $f = 100 \text{ kHz}, T_{vj} = 25 \text{ }^\circ\text{C}, V_{GS} = 0 \text{ V}$

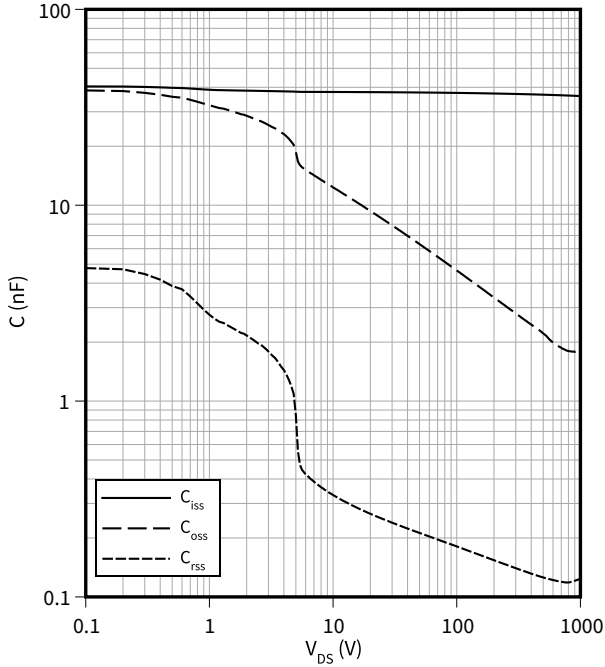

Forward characteristic body diode (typical), MOSFET

$I_{SD} = f(V_{SD})$
 $T_{vj} = 25 \text{ }^\circ\text{C}$

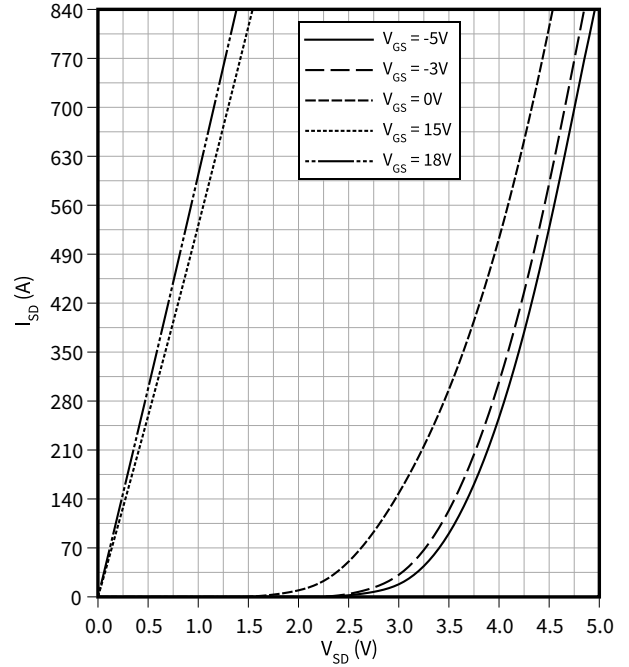

Forward voltage of body diode (typical), MOSFET

$V_{SD} = f(T_{vj})$
 $I_{SD} = 420 \text{ A}$

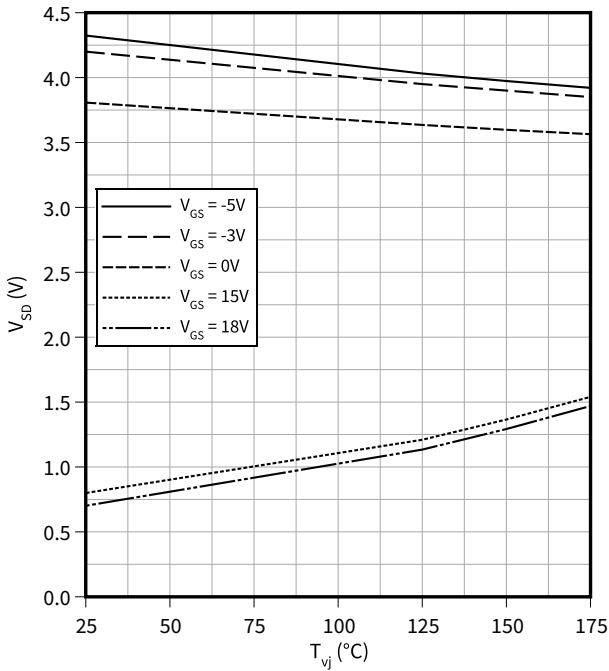

Switching losses (typical), MOSFET

$E = f(I_D)$
 $R_{Goff} = 1.5 \text{ } \Omega, R_{Gon} = 4.7 \text{ } \Omega, V_{DD} = 600 \text{ V}, V_{GS} = -3/18 \text{ V}$

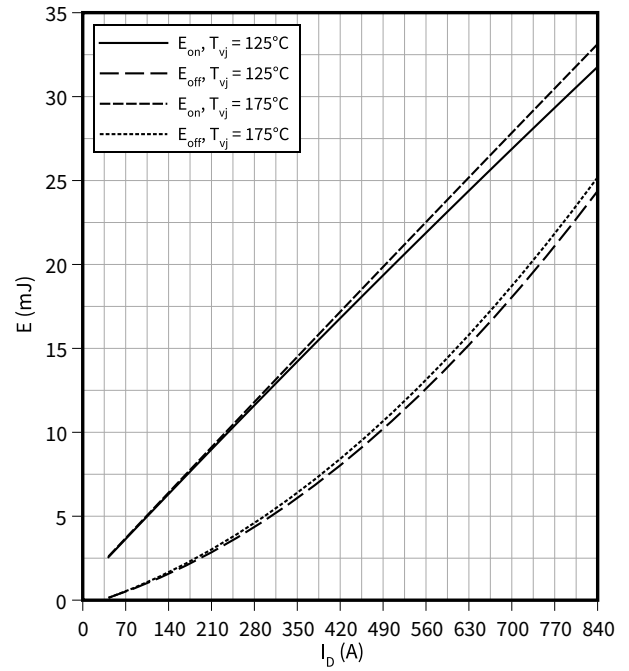

4 Characteristics diagrams

Switching losses (typical), MOSFET

$E = f(R_G)$

$V_{DD} = 600\text{ V}, I_D = 420\text{ A}, V_{GS} = -3/18\text{ V}$

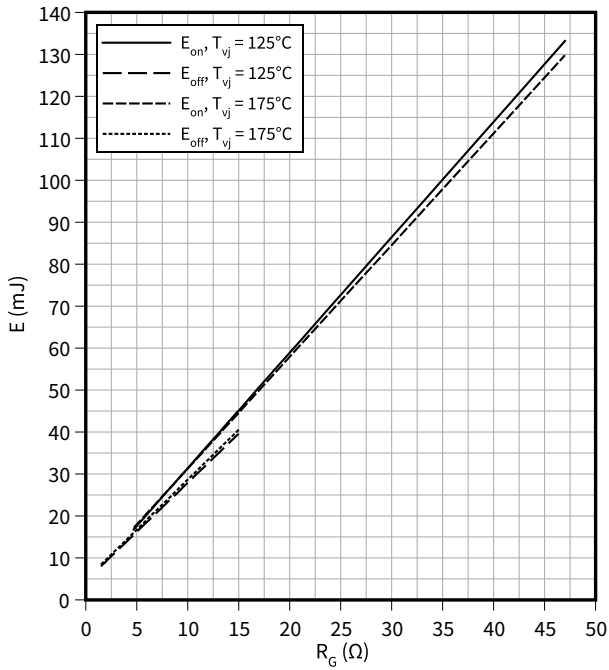

Switching times (typical), MOSFET

$t = f(I_D)$

$R_{Goff} = 1.5\ \Omega, R_{Gon} = 4.7\ \Omega, V_{DD} = 600\text{ V}, T_{vj} = 175\text{ }^\circ\text{C}, V_{GS} = -3/18\text{ V}$

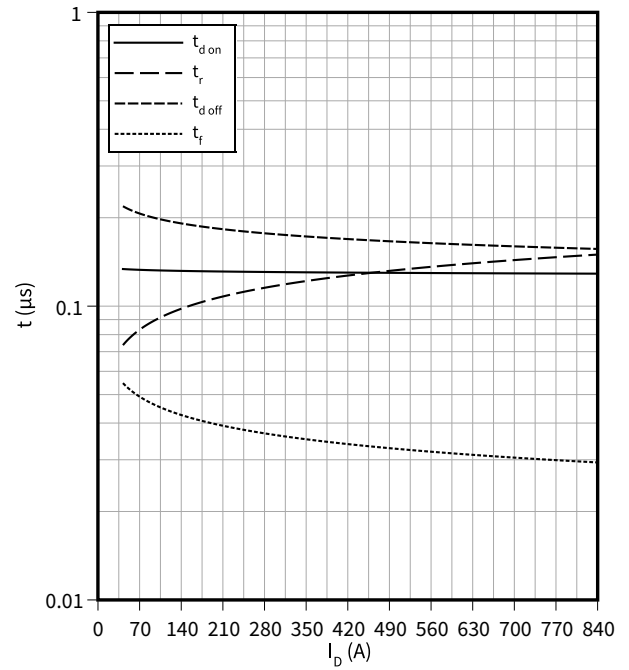

Switching times (typical), MOSFET

$t = f(R_G)$

$V_{DD} = 600\text{ V}, I_D = 420\text{ A}, T_{vj} = 175\text{ }^\circ\text{C}, V_{GS} = -3/18\text{ V}$

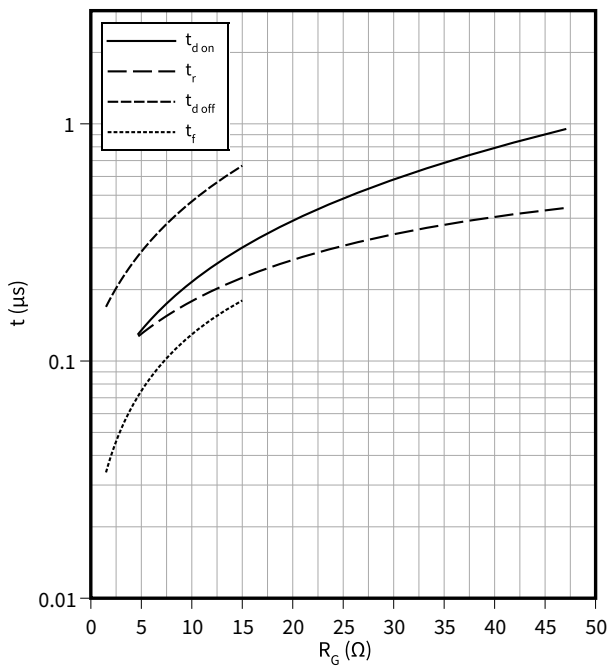

Current slope (typical), MOSFET

$di/dt = f(R_G)$

$V_{DD} = 600\text{ V}, I_D = 420\text{ A}, V_{GS} = -3/18\text{ V}$

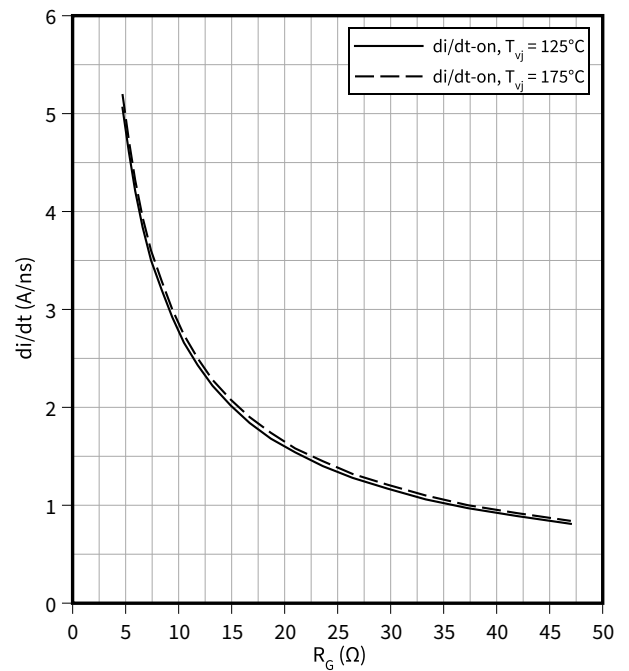

4 Characteristics diagrams

Voltage slope (typical), MOSFET

$dv/dt = f(R_G)$

$V_{DD} = 600\text{ V}, I_D = 420\text{ A}, V_{GS} = -3/18\text{ V}$

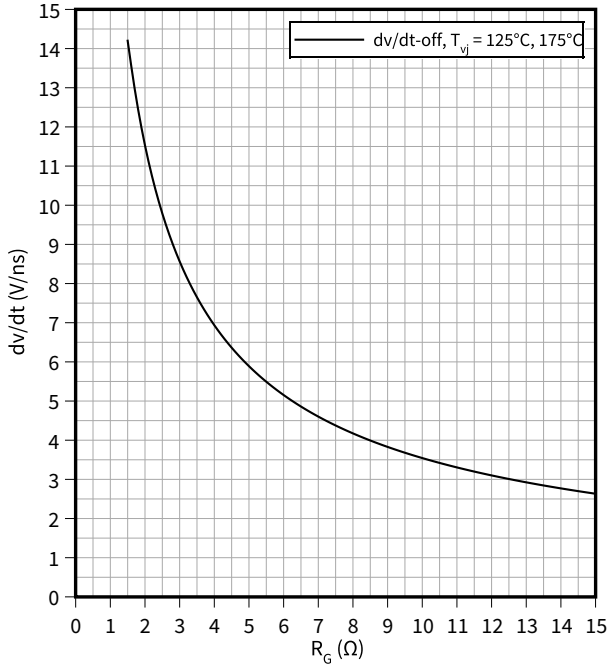

Reverse bias safe operating area (RBSOA), MOSFET

$I_D = f(V_{DS})$

$R_{Goff} = 1.5\ \Omega, T_{vj} = 175\ ^\circ\text{C}, V_{GS} = -3/18\text{ V}$

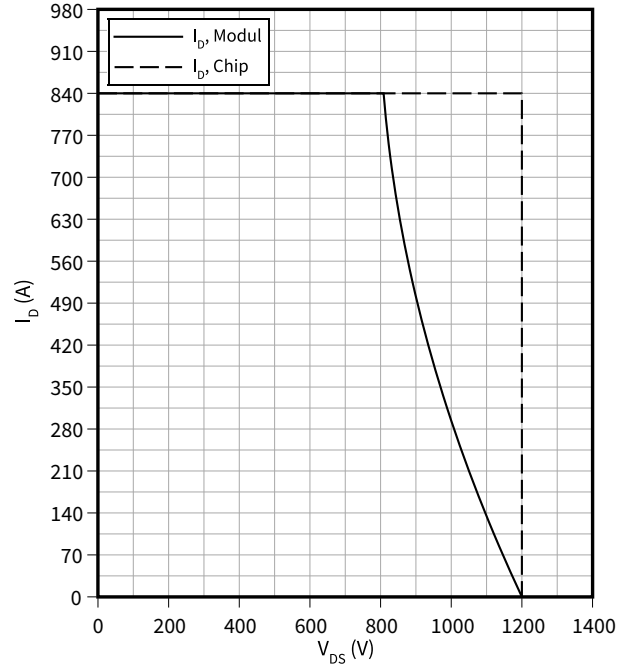

Transient thermal impedance, MOSFET

$Z_{th} = f(t)$

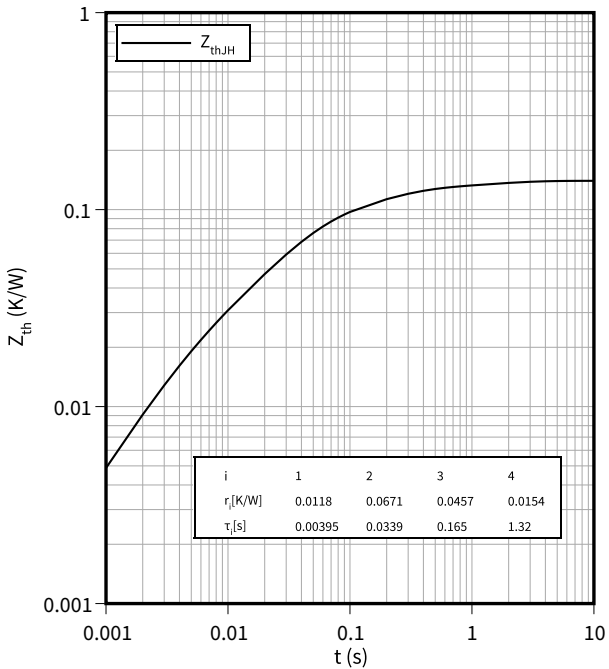

5 Circuit diagram

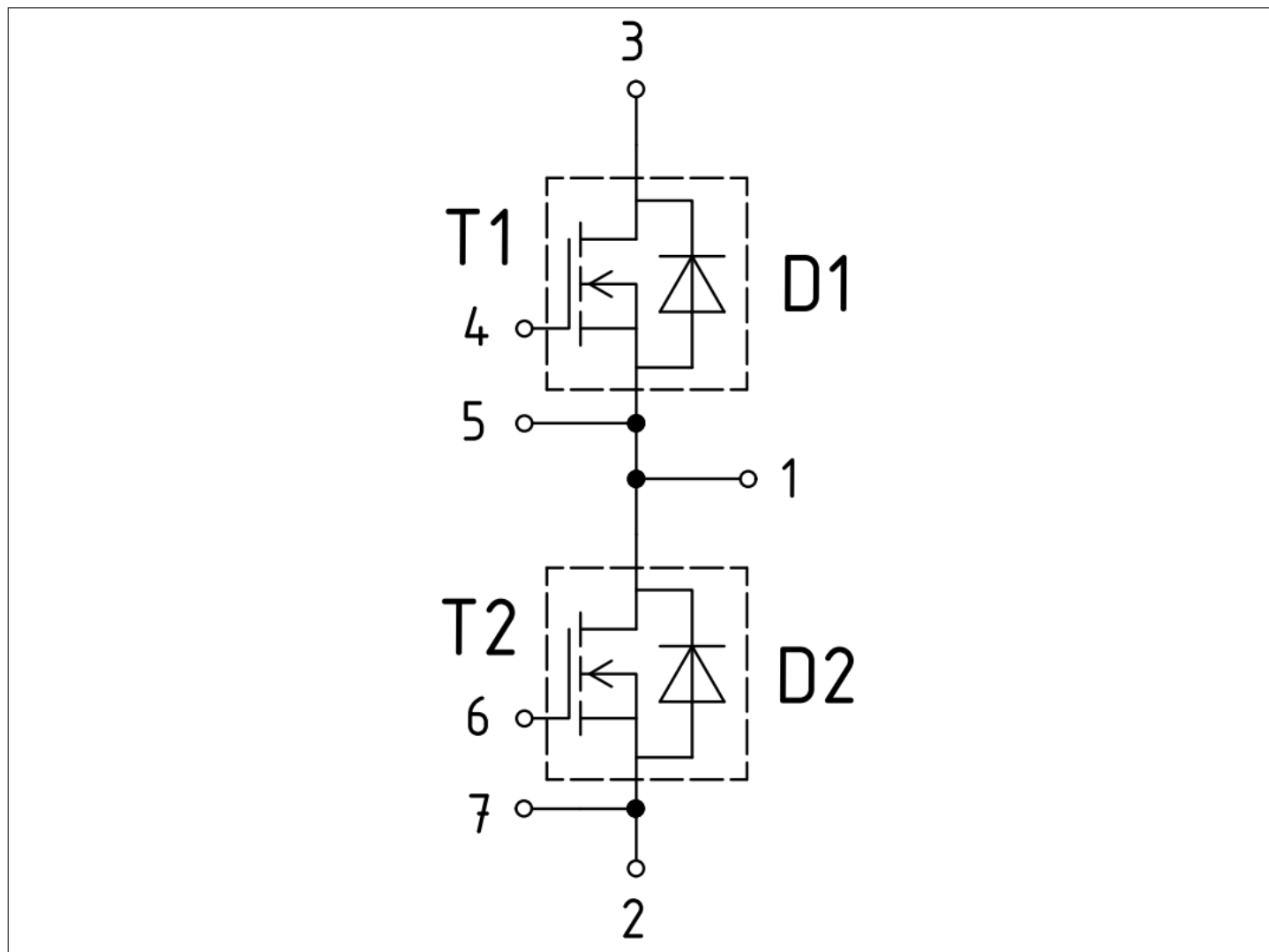

Figure 1

6 Package outlines

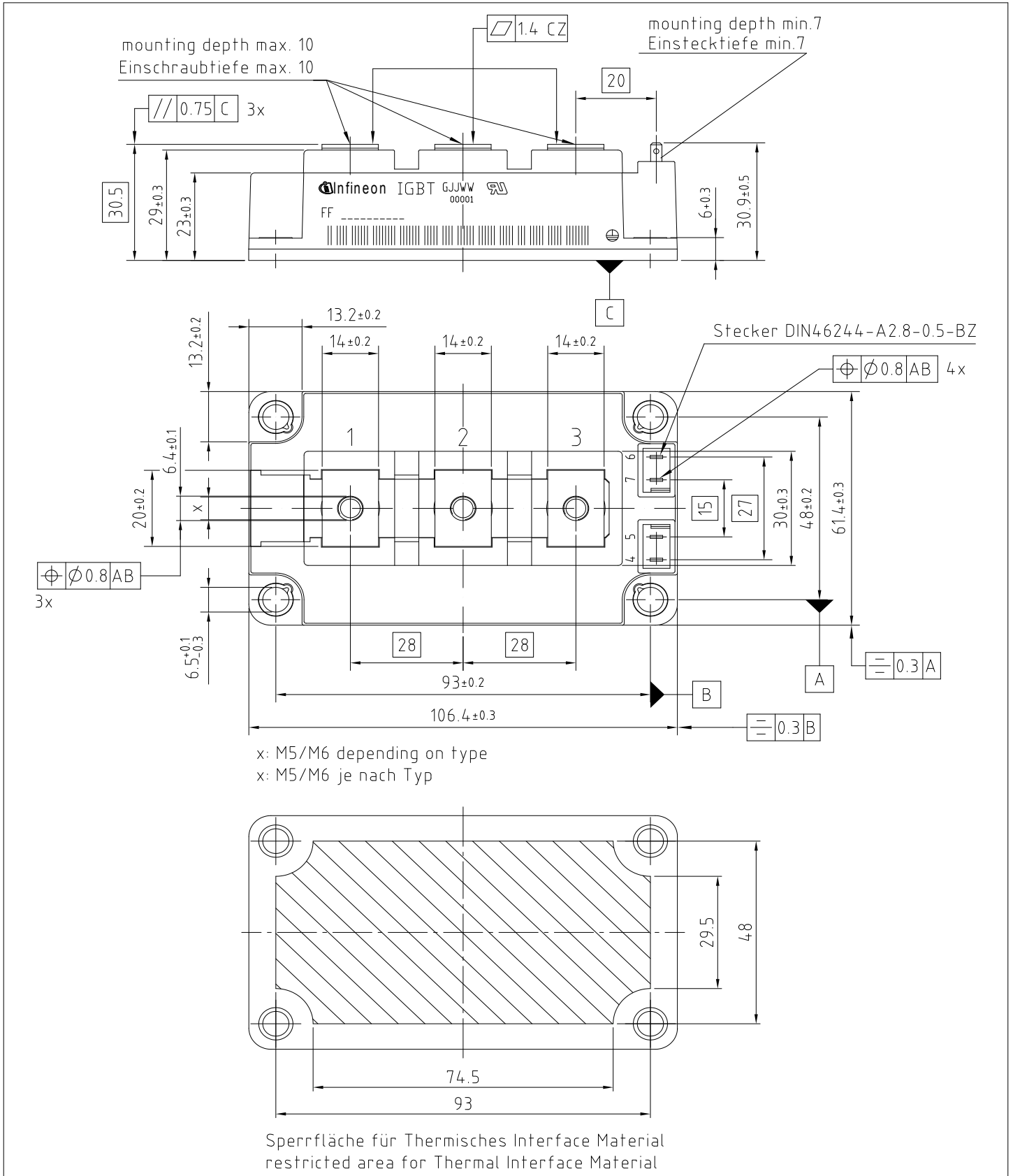

Figure 2

7 Module label code

Module label code			
Code format	Data Matrix	Barcode Code128	
Encoding	ASCII text	Code Set A	
Symbol size	16x16	23 digits	
Standard	IEC24720 and IEC16022	IEC8859-1	
Code content	<i>Content</i> Module serial number Module material number Production order number Date code (production year) Date code (production week)	<i>Digit</i> 1 - 5 6 - 11 12 - 19 20 - 21 22 - 23	<i>Example</i> 71549 142846 55054991 15 30
Example	<div style="display: flex; justify-content: space-around; align-items: center;"> <div style="text-align: center;">  71549142846550549911530 </div> <div style="text-align: center;">  71549142846550549911530 </div> </div>		

Figure 3

Revision history

Document revision	Date of release	Description of changes
0.10	2023-01-20	Initial version
0.20	2023-03-03	Preliminary datasheet

Trademarks

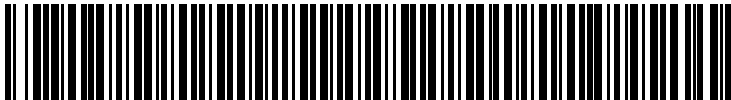
All referenced product or service names and trademarks are the property of their respective owners.

Edition 2023-03-03

Published by

Infineon Technologies AG

81726 Munich, Germany

© 2023 Infineon Technologies AG

All Rights Reserved.

Do you have a question about any aspect of this document?

Email: erratum@infineon.com

Document reference

IFX-ABG202-002

Important notice

The information given in this document shall in no event be regarded as a guarantee of conditions or characteristics ("Beschaffheitsgarantie").

With respect to any examples, hints or any typical values stated herein and/or any information regarding the application of the product, Infineon Technologies hereby disclaims any and all warranties and liabilities of any kind, including without limitation warranties of non-infringement of intellectual property rights of any third party.

In addition, any information given in this document is subject to customer's compliance with its obligations stated in this document and any applicable legal requirements, norms and standards concerning customer's products and any use of the product of Infineon Technologies in customer's applications.

The data contained in this document is exclusively intended for technically trained staff. It is the responsibility of customer's technical departments to evaluate the suitability of the product for the intended application and the completeness of the product information given in this document with respect to such application.

Warnings

Due to technical requirements products may contain dangerous substances. For information on the types in question please contact your nearest Infineon Technologies office.

Except as otherwise explicitly approved by Infineon Technologies in a written document signed by authorized representatives of Infineon Technologies, Infineon Technologies' products may not be used in any applications where a failure of the product or any consequences of the use thereof can reasonably be expected to result in personal injury.

X-ON Electronics

Largest Supplier of Electrical and Electronic Components

Click to view similar products for [Discrete Semiconductor Modules](#) category:

Click to view products by [Infineon](#) manufacturer:

Other Similar products are found below :

[M254045V](#) [M254085](#) [DD380N16A](#) [DDB6U145N16L](#) [DR7306](#) [DZ540N26K](#) [EFG15D](#) [B484-2](#) [B485A-2](#) [B522F-2-YEC](#) [25.320.4853.1](#)
[25.320.5253.1](#) [25.334.3253.1](#) [25.334.3353.1](#) [25.350.2053.0](#) [25.352.4753.1](#) [25.522.3253.0](#) [T2180N18TOF](#) [VT](#) [T484C](#) [T485F](#) [T485H](#) [T514F](#)
[T554](#) [T582](#) [25.332.4353.1](#) [25.350.1653.0](#) [25.352.1453.0](#) [25.352.1653.0](#) [25.352.2453.0](#) [25.352.5453.1](#) [25.522.3353.0](#) [25.640.5053.0](#)
[M252532V](#) [M252555](#) [M2550TB400](#) [M471B5673EH1-CH900](#) [M505012F-YEC](#) [TD330N16AOF](#) [B512-2T-YDA](#) [TT215N22KOF](#)
[TT251N16KOF](#) [V100-35.200N](#) [V72-26.150M](#) [DD700N22K](#) [DD89N16K](#) [DD98N22K](#) [MSD30-12](#) [MSKD120-16](#) [TD500N16KOF](#)
[TT425N18KOF](#)