

Dimensioning program IPOSIM for loss and thermal calculation of Infineon IGBT modules

Introduction

IPOSIM performs an approximate calculation of switching and conduction losses for IGBTs and free-wheeling diodes in a three phase inverter configuration under the assumption of sinusoidal output currents at inductive loads. With this tool a quick selection of a suitable Infineon IGBT module for an application is possible taking into account its average losses and thermal ratings. Be sure to always have the latest IPOSIM version on-hand. The actual program is available on [Home > Product Categories > Modules and Disks > IGBT Modules > Download Service > IPOSIM](#).

DC-link voltage, output and switching frequency, maximum junction temperature, expected case temperature, modulation factor and $\cos \varphi$ can be adapted to specific operation points.

The calculation results in diagrams which are showing an estimation of the average power losses at sinusoidal currents versus the RMS phase leg current. The thermal limits of IGBT and diode part of the module (taking into account their thermal resistances and the given values for case and maximum junction temperature) are considered.

IPOSIM applies an easy to use, fast and at the same time relatively exact method for loss calculation under sinusoidal output conditions. This fulfills the engineer's need for first estimations on losses and thermal limits of the considered IGBT module. Points to be aware of:

- IPOSIM device data are based on values given in the respective IGBT module data-sheet. The product data as well as the data used in IPOSIM may be subject to changes, improvements or corrections without prior notice.
- Calculations are based on linear approximations, e.g. for the device's forward characteristics, the derivation of switching losses and assumptions e.g. for the recovery energies. Detailed informations on the calculations are given on the following pages.
- Operating conditions may differ from simulation assumptions in several aspects like level of DC-link voltage, applied gate-voltage and gate-resistor, case and junction temperatures as well as the power circuit stray-inductance. Therefore deviations of parameters and assumptions used for the simulation and the real application may exist.

For these reasons Infineon can not take any responsibility or liability for the exactness or validity of the program's results. The program can not replace a detailed reflection of the customers application with all of its operating conditions.

IPOSIM web tool

The Excel based design spreadsheet helps to select products quickly under a variety of operating conditions. However the analytical calculations available in Excel are limited to the selection of a typical sine-triangle control, which in many cases does not reflect the actual stress a part can see under varying controller and load conditions.



Therefore an online version of IPOSIM has been developed. Please visit <http://web.transim.com/Infineon-IPOSIM>. This new online tool makes it very easy for users to logon and perform an entire design from product and topology selection to thermal and electrical analysis in a short 10 – 20 minutes online session – no need for downloads and installations.

The IPOSIM web tool covers a wide variety of power electronic applications and controls.

IPOSIM Infineon Power Module Selector and Simulator

AC/DC Applications

Single phase

- ▶ B2U - Two-pulse bridge uncontrolled
- ▶ B2C - Two pulse bridge fully controlled

Three phase

- ▶ B6U - Six-pulse bridge uncontrolled
- ▶ B6C - Six-pulse bridge fully controlled
- ▶ M3.2U - Double three-pulse star uncontrolled
- ▶ M3.2C - Double three-pulse star fully controlled
- ▶ M6U Six-pulse star uncontrolled
- ▶ M6C Six-pulse star fully controlled

AC/AC Applications

Single Phase

- ▶ W1C phase control

Three Phase

- ▶ W3C phase control

DC/DC Applications

- ▶ Boost
- ▶ Buck

DC/AC Applications

- ▶ Single Phase
- ▶ Three Phase - 2 Level
- ▶ Three Phase - 3 Level



Bipolar modules or disk devices will be selected for AC/DC rectifier (B2, B6, M3.2 and M6) or AC/AC switch (W1C and W3C) applications as well as suited IGBT modules for your DC/DC converter (buck and boost) or DC/AC inverter (single & three phase in 2-Level as well as 3-Level) applications.

Where applicable, different control algorithms can be applied. Thermal conditions can be adapted by user defined or predefined heat sinks. Beside single operation points complete load cycles may be calculated. Results will be shown in tabular and graphic representation and can be saved for later revision or printed as pdf file.

Calculation

The calculation of the average, total power dissipation of IGBT and diode P_{av} are done by a closed solution approach for the conduction losses P_{cond} and switching losses P_{sw} during the duration T_0 of one period of the output. The closed solution for P_{sw} does not require summing up several switching energies of the switched device. [D. Srajber, W. Lukasch: The calculation of the power dissipation for the IGBT and the inverse diode in circuits with the sinusoidal output voltage; electronica '92 Proceedings, pp. 51-58]

$$P_{av} = \frac{1}{T_0} \cdot \sum (E_{cond} + E_{on} + E_{off})$$

$$= P_{cond} + P_{sw}$$

IGBT:

The **conduction losses** are given by:

$$P_{cond,IGBT} = \frac{1}{T_0} \int_0^{T_0/2} v_{CE}(t) \cdot i(t) \cdot \tau'(t) dt$$

with

$$i(t) = \hat{i} \sin(\omega t) : \quad \text{sinusoidal output current}$$

$$v_{CE}(t) = V_{CE0} + r \cdot i(t) : \quad \text{on-state voltage according to output characteristic } i = f(v_{CE})$$

$$\tau'(t) : \quad \text{function of pulse pattern with IGBT turned-on} = 1 \text{ and IGBT turned-off} = 0$$

In fact, it is the duty cycle of the IGBT (duration over the switching period). τ' can be substituted by a function of time, modulation and phase angle, which is derived from an extrapolation of the intersections of a saw tooth with a reference sinus. The formula is obtained by writing the duty cycle variation over the time and making the switching frequency infinite (discrete to continuous integration).

$$\tau(t) = \frac{1}{2}(1 + m \sin(\omega t + \varphi))$$

which leads to an easy to solve expression for the conduction losses.

$$P_{cond,IGBT} = \frac{1}{T_0} \int_0^{T_0/2} (V_{CE0} + r \hat{i} \sin(\omega t)) * \hat{i} \sin(\omega t) * \left(\frac{1}{2}(1 + m \sin(\omega t + \varphi))\right) dt$$

$$= \frac{1}{2} \left(V_{CE0} \cdot \frac{\hat{i}}{\pi} + r \cdot \frac{\hat{i}^2}{4} \right) + m \cdot \cos \varphi \cdot \left(V_{CE0} \cdot \frac{\hat{i}}{8} + \frac{1}{3\pi} \cdot r \hat{i}^2 \right)$$

with the modulation factor m as the relation of AC output amplitude to DC-link voltage:

$$m \leq 1 : \quad \text{linear mode of the PWM}$$

$$1 \leq m \leq 4/\pi : \quad \text{over-modulation}$$

$$m = 4/\pi : \quad \text{square wave operation}$$

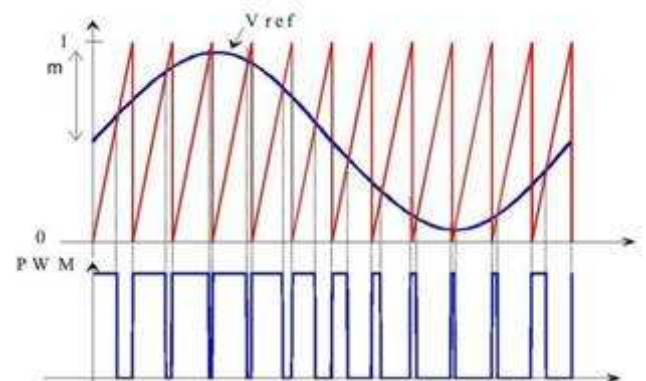

As τ' is a duty cycle, it can't be greater than 1. Thus values of $m > 1$ represent an equivalent area of a non-sinusoidal reference signal.

The **switching losses** can be expressed as the integration of all turn-on and turn-off energies at the switching instants.

$$P_{sw,IGBT} = f_{sw,IGBT} \cdot \frac{1}{T_0} \int_0^{T_0/2} (E_{on} + E_{off})(t, \hat{i}) dt$$

Using the measured turn-on and turn-off energy dissipation per switching pulse (given in the data-sheets at nominal current I_{nom}) the energy of the single switching event at a temporary current i can be assumed linear.

Furthermore the applied DC-link voltage at several applications may vary from the nominal DC voltage used for the determination of the losses. The practice shows, that a linear adjustment of the losses within a certain limit of the nominal voltage (here $\pm 20\%$) is permissible.

$$E_{sw,IGBT}(i) = E_{on,IGBT}(I_{nom}, V_{nom}) + E_{off,IGBT}(I_{nom}, V_{nom}) \frac{i}{I_{nom}} \cdot \frac{V_{dc}}{V_{nom}}$$

To solve for the total switching losses of the IGBT the switching energies have to be added up:

$$P_{sw,IGBT} = \frac{1}{T_0} \cdot \sum_n E_{sw,IGBT}(i_n)$$

The number n is given by the relation of output frequency f to switching frequency f_{sw} . An approximated, closed solution for the IGBT switching losses at a phase leg current i is given by the following formula:

$$P_{sw,IGBT} = \frac{1}{\pi} f_{sw} \cdot (E_{on}(I_{nom}, V_{nom}) + E_{off}(I_{nom}, V_{nom})) \frac{\hat{i}}{I_{nom}} \cdot \frac{V_{dc}}{V_{nom}}$$

Diode:

The diode losses can be calculated in a similar way:

$$P_{cond,Diode} = \frac{1}{2} (V_{T0} \cdot \frac{\hat{i}}{\pi} + r_T \cdot \frac{\hat{i}^2}{4}) - m \cdot \cos \cdot (V_{T0} \cdot \frac{\hat{i}}{8} + \frac{1}{3\pi} \cdot r_T \hat{i}^2)$$

The turn-on losses of the diode can be neglected in the diode switching losses. We receive the turn-off recovery losses by summing up the recovery energies

$$P_{sw,Diode} = \frac{1}{T_0} \cdot \sum_n E_{rec}(I_{nom}, V_{nom}) \frac{i_n}{I_{nom}} \frac{V_{dc}}{V_{nom}}$$

where i_n is the instantaneous phase leg current according to $i(t) = \hat{i} \sin(\omega t)$. In the final calculation we derive the turn-off energy at a certain current not by a linear scaling of the recovery energy $E_{rec}(I_{nom})$, but by the approach (updated with revision IPOSIM 7-7a)

$$E_{rec}(\hat{i}) = E_{rec}(I_{nom}) * (0.8 \sqrt{\frac{\hat{i}}{I_{nom}}} + 0.2)$$

which fits better to the non-linearity of the "recovery energy vs. current" curves. With this, the diode losses can be written after integration of the former formula as:

$$P_{sw,Diode} = f_{sw} \cdot E_{rec}(I_{nom}) * (\frac{0.8}{\pi} 1.2 \sqrt{\frac{\hat{i}}{I_{nom}}} + \frac{1}{2} 0.2) \cdot \frac{V_{dc}}{V_{nom}}$$

Module lead resistance:

The lead resistance is the resistive value of the connection between power terminals and chips.

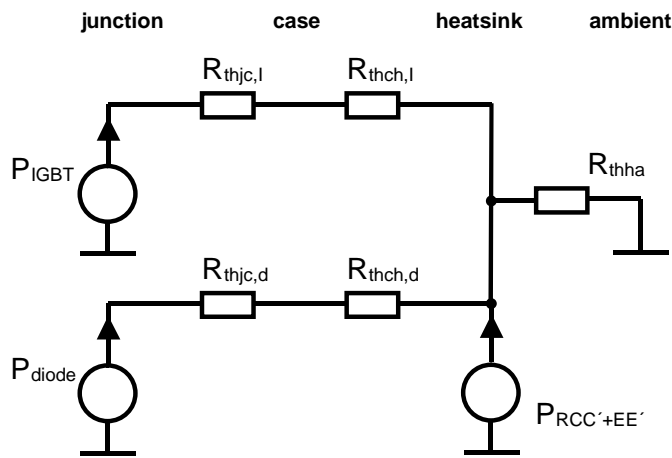

Considering this value a better utilization of the module as well as a more accurate rating of the thermal design is possible. The chip-related data specification of the forward voltages allows a more accurate determination of the junction temperature, while the total losses, which have to be removed from the module by the heat sink, are also available. If the IPOSIM input field

shows a line named "module lead resistance $R_{CC'+EE'}$ / mΩ", then this value is available in the data sheet. In the result diagram the curve "losses per switch" cover the IGBT, diode and lead resistance losses.

The thermal model indicates, that the parasitic losses of the lead resistance $P_{RCC'+EE'}$ are not longer considered as part of IGBT or diode chip losses. They are partly dissipated through the main terminals, but as a worst case condition, it is assumed, that all losses are injected into the module's base plate. The above shown thermal equivalent circuit clarifies how device and parasitic losses are considered in the thermal calculation explained later on.

$$\begin{aligned} \bar{P}_{RCC'+EE'} &= \frac{1}{T_0} \int_0^{T_0/2} R_{CC'+EE'} \cdot \hat{i}^2 \sin^2(\omega t) dt \\ &= R_{CC'+EE'} \cdot \frac{\hat{i}^2}{4} \end{aligned}$$

The temperature dependency of the module lead resistance is specified by

$$R_{CC'+EE'}(\vartheta_{lead}) = [1 + \alpha(\vartheta_{lead} - 25^\circ\text{C})] \cdot R_{CC'+EE'}(25^\circ\text{C}) \text{ with } \alpha = 3.85 \cdot 10^{-3} \text{K}^{-1} \text{ for copper}$$

and taken into consideration under the assumption of $\vartheta_{lead} = \vartheta_{case}$.

Before you start

IPOSIM uses macros for its calculations. If these are not activated, you will get a corresponding query from Excel. IPOSIM won't work. To activate the macros, the default security setting of your Excel program has to be changed. This setting is located in:

"Tools" --> "Options" --> "Security" --> "Macro Security..." --> "Security Level".

It should be set to "Medium", not "High". Otherwise the above problem will occur.

After the setting is changed from "High" to "Medium" and saved, the next time IPOSIM is opened, a "Security Warning" will be prompted. Please select "Enable Macros". Then IPOSIM shall function normally.

Input for the calculation

Start with sheet **“autom. selection”**. Enter your application dependent inputs into the left, green-shaded fields. IPOSIM checks, if these values comply with applicable limits. The parameters finally used for the simulation are given in the right, yellow-shaded field. If deviations occur between input and parameters used for simulation, these will be highlighted.

IPOSIM will select admissible modules, considering the required voltage class and a sufficient current rating for the module. The IGBT module product range from Infineon comprises voltage classes from 600V to 6500V. The test voltages used for characterization and the typical operation range are shown in the following list:

voltage class	test voltage	typical operation range
600 V	300 V	240 to 360 V
1200 V	600 V	480 to 720 V
1700 V	900 V	720 to 1080 V
3300 V	1800 V	1440 to 2160 V
4500 V	2800 V	2240 to 3000 V
6500 V	3600 V	3000 to 4320 V

An interpolation of dynamic losses for applications with voltages deviating from the test voltage value can be performed with low failure within the typical operation range of test voltage +/- 20%. If you are not in the ‘typical operation range’ for a given voltage class, IPOSIM will issue a corresponding notice.

The blue layered fields show the static and dynamic losses for the selected module in the considered operation point. IPOSIM will always calculate and display the losses per single switch, independent if a single (FZ..), dual (FF..), six-pack (FS..) or other module configuration has been chosen.

IGBT Power Simulation for Infineon IGBT modules V6.1a September 2006 module selection for 3-phase inverter applications

[IPOSIM.PDF](#)
[Info](#)

average losses for sinusoidal output current

Please specify your inverter application in the green layered fields:	application parameters:	simulation parameters:	limits:
DC link voltage V_{dc} [V]	900	900	$0 V \leq V_{dc} \leq 4320 V$
RMS current I_{rms} [A]	500	500	
frequency f_0 [Hz]	50	50	$1 Hz \leq f_0 \leq 1000 Hz$
switching frequency f_s [Hz]	2000	2000	$5 \times f_0 \leq f_s \leq 10000 \times f_0$
max. junction temperature T_j [°C]	125	125	$-40 \text{ °C} \leq T_j \leq 125 \text{ °C}$
case temperature T_c [°C]	80	80	$-40 \text{ °C} \leq T_c \leq T_j$
modulation factor m	1,00	1,00	$0 \leq m \leq 4/3$
$\cos \varphi$	1,00	1,00	$-1 \leq \cos \varphi \leq 1$

Selected voltage class [V]

1700

select a module:

FF800R17KE3

select a housing:

IHM140*130dual

static IGBT losses [W]	403	
dynamic IGBT losses [W]	293	Σ 696
static diode losses [W]	34	
dynamic diode losses [W]	136	Σ 170



average losses for sinusoidal output current at 2000 Hz switching frequency

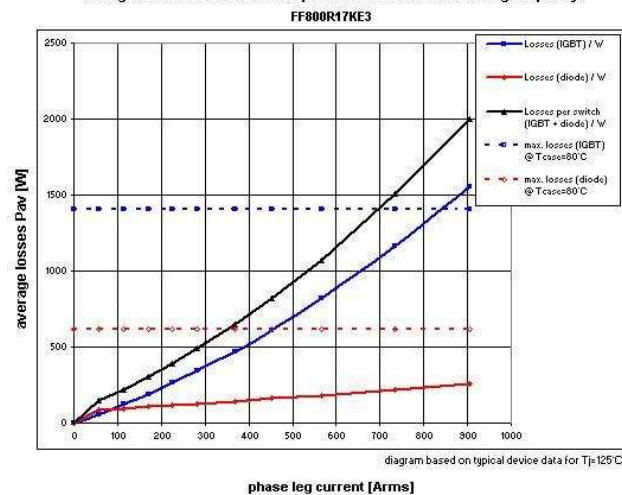

how to read the diagram:

The cross point between the blue (or red) solid line and the blue (or red) dotted line delivers the highest allowed IGBT (or diode) RMS phase leg current at the given operation conditions.

In consideration of the limits regarding required blocking voltage and current rating you can choose among the contemplable modules from the left drop-down menu. By means of the second drop-down menu you are furthermore able to restrict the selection to a single housing type.

An example for the available housing types are shown on the next page.



For every parameter change on sheet “autom. selection”, IPOSIM will newly calculate and – where applicable – newly select devices. By moving further to the next sheet “**selected module**” you may now change freely all parameters for the module, which has been pre-selected on the last sheet.

This is the input mask you may know from earlier IPOSIM versions.

**IGBT Power Simulation for Infineon IGBT modules V6.1a September 2006
module selection for 3-phase inverter applications**

IPOSIM.PDF Info



average losses for sinusoidal output current

selected module	FF800R17KE3	
Please specify your inverter application in the green layered fields:	application parameters:	simulation parameters:
DC link voltage V _{dc} [V]	900	900
RMS current I _{rms} [A]	500	500
frequency f ₀ [Hz]	50	50
switching frequency f _s [Hz]	2000	2000
max. junction temperature T _j [°C]	125	125
case temperature T _c [°C]	80	80
modulation factor m	1,00	1,00
cos φ	1,00	1,00
suggested min. gate-resistor R _g [Ω]		1,8 / 2,2
module lead resistance R _{CC-EE} [mΩ]		0,37

limits:
 nom. voltage 900 V +20%
 720 V ≤ V_{dc} ≤ 1080 V
 I_{rms} ≤ 841 A loss limitation
 1 Hz ≤ f₀ ≤ 10000 Hz
 5 × f₀ ≤ f_s ≤ 10000 × f₀
 -40 °C ≤ T_j ≤ 125 °C
 -40 °C ≤ T_c ≤ T_j
 0 ≤ m ≤ 4π
 -1 ≤ cos φ ≤ 1

static IGBT losses [W]	403	
dynamic IGBT losses [W]	293	Σ 696
static diode losses [W]	34	
dynamic diode losses [W]	136	Σ 170

average losses for sinusoidal output current at 2000 Hz switching frequency
FF800R17KE3

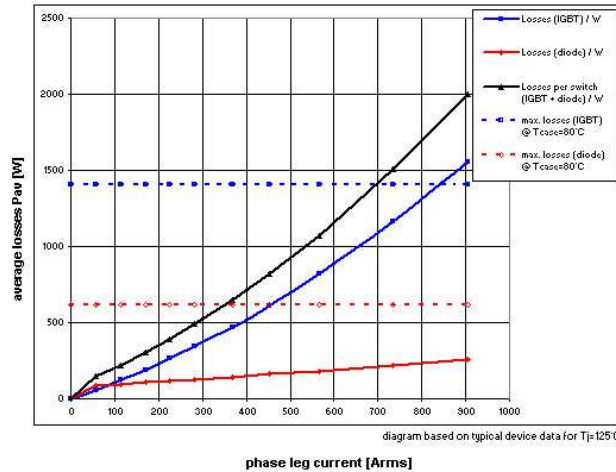

how to read the diagram:
 The cross point between the blue (or red) solid line and the blue (or red) dotted line delivers the highest allowed IGBT (or diode) RMS phase leg current at the given operation conditions.

Once you have decided for one of the recommended modules, this page will be your favourable choice. Working on this sheet gives faster response to changes because IPOSIM does not any longer require continuous recalculations for all available modules.

Interpreting the diagram “average losses vs. phase leg current”

The calculation results in the diagram are showing the average power losses P_{av} at sinusoidal currents versus the RMS phase leg current.

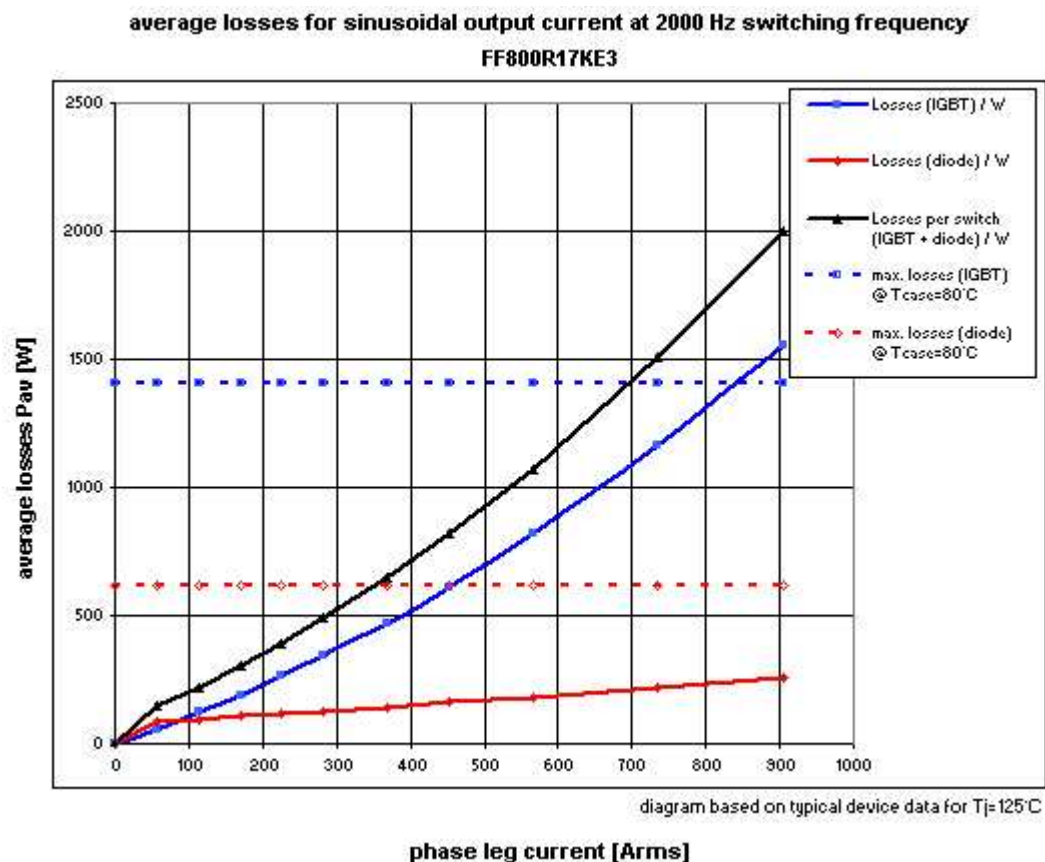

The cross points between the blue (or red) solid line and the blue (or red) dotted line indicate the highest allowed IGBT (or diode) RMS phase leg current at the given operation conditions. The thermal limits of IGBT and diode, shown by the horizontal lines ‘max. losses’, are derived by incorporating the thermal resistance Z_{thjc} and the given values for case and maximum junction temperature. The calculation assumes sinusoidal power dissipation with average power losses of P_{av} .

The maximum permissible phase currents for IGBT and diode can be read at the crossing of the P_{av} curves with the ‘max. losses’ curves. In the shown example and with the given operating conditions, the maximum achievable phase leg current by the IGBT is appr. 1000 A while no thermal limitations exist with regard to the diode. If there is no thermal limitation reached, the RMS phase leg current will be restricted due to the limit of the RBSOA to $2 * I_{nom} / \sqrt{2}$.

Be aware, that the achievable currents strongly depend on your assumption about the case temperature. This temperature will directly influence the height of the dotted line, i.e. the maximum RMS phase leg current. The case temperature is usually just a ‘first guess’. The next sheet “temperature distribution” will offer the option to enter the thermal resistance of the heat sink and the ambient temperature. With these values available, a much more reliable assessment of the thermal conditions are feasible.

Benchmarking

While the first two worksheets focus on a single device, the following sheet **“ampacity and benchmark”** offers the opportunity to compare two or more devices regarding their current carrying capability under identical operation conditions.

When entering the page, the initial application parameters will be taken over and you may enter a range of switching frequencies for which the achievable current should be calculated. Three drop down boxes will suggest widely comparable modules or allow you to select other modules of the same voltage class for comparison.

Since latest IGBT3 chips allow for operation above 125°C, these devices will be initialized with a maximum junction temperature of 150°C.

After selecting modules and entering data to the green layered fields, activate the comparison by pushing the button ‘start benchmark’.

IGBT Power Simulation for Infineon IGBT modules V6.1a September 2006
module selection for 3-phase inverter applications

IPOSIM.PDF

Info



current carrying capability vs. switching frequency

Please specify your inverter application in the green layered fields:

application parameters:
 DC link voltage V_{dc} [V]: 900
 frequency f₀ [Hz]: 50
 switching frequency f_s [Hz]: 250 to 2000
 modulation factor m: 1,00
 cos φ: 1,00
 max. ambient temperature T_a [°C]: 40

simulation parameters:
 900
 50
 250...2000
 1,00
 1,00
 40

limits:
 nom. voltage 900 V +20%
 720 V ≤ V_{dc} ≤ 1080 V
 1 Hz ≤ f₀ ≤ 1000 Hz
 5 × f₀ ≤ f_s ≤ 10000 × f₀
 0 ≤ m ≤ 4/π
 -1 ≤ cos φ ≤ 1
 0 °C ≤ T_a ≤ T_c

choose:
 IGBT Diode

select up to three modules for benchmark

housing type	R _{th} IGBT-junction to case [K/W]	R _{th} case to heat sink per IGBT [K/W]	R _{th} heat sink per module arm [K/W]	max. junction temp. T _J [°C]	
FF800R1TKE3	IHM140*130.dvs1	0,0280	0,017	0,060	125
FF600R1TKE3	IHM140*130.dvs1	0,0340	0,017	0,060	125
FF800R1TKE3_B2	IHM140*130.dvs1	0,0240	0,025	0,060	125
FF600R1TKF6C_B2	IHM140*130.dvs1	0,0260	0,024	0,060	125

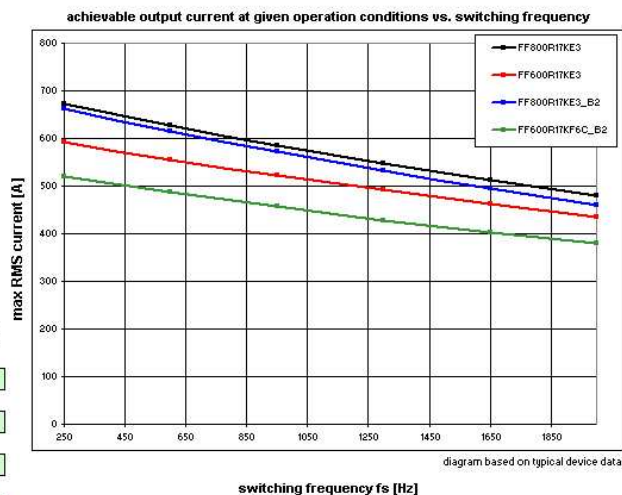

how to read the diagram:

The diagram shows the maximum achievable RMS output current for different switching frequencies under the given operation and cooling conditions. Choose up to four modules to compare their performance.

Avoid to compare apples with pears ! Comparing modules of different housing types is possible, but needs at least some considerations regarding the thermal resistance per module. IPOSIM will initialize the corresponding, green layered input cells with the same value (set on sheet “temperature distribution”). These values should be either adapted according to the base plate size of the specific module or by assuming different heat sinks according to the list of typical heat sink values given later in this document.

FAQs

- *The curve „losses“ ends although the line „max. losses“ is still not reached !*

There are two values, which might limit the maximum allowed RMS current value:

- the thermal limit, if $P_{tot} * R_{th_{jc}}$ of IGBT or diode exceeds the input for $T_j - T_{case}$ or
- the current peak capability which is limited by the RBSOA to $I_{RMS} = 2 * I_{nom} / \sqrt{2}$.

- *Why does the diode loss curve tends to show a bending in the lower current range ?*

The bending is always present, but only catches someone's eyes when the calculation is done at low current / high switching frequencies. To approximate the non-linear function of $E_{rec}=f(I)$, the formula $E_{rec}(I) = E_{rec}(I_{nom}) * (I/I_{nom} * 0,45 + 0,55)$ is used. The bending arises by enforcing $E_{rec}(I=0)$ to 0.

- *How does IPOSIM calculate for junction temperatures which are unequal to 25°C or T_{jmax} ?*

The static losses for IGBT and diode as well as E_{rec} for a given junction temperature are derived by linear interpolation of the 25°C and 125°C data sheet values.

- *Can I change the Rg_{on} or Rg_{off} values ?*

Rg_{on} or Rg_{off} are not a input values for IPOSIM. In fact, you have to adapt the switching losses. Read the corresponding values for E_{on} , E_{off} and E_{rec} from the diagram part of the data sheet. On sheet "values" copy the row of the respective module to the end of the table (only here datas can be edited) and modify the values for E_{tot} and E_{rec} . For this see the last page of this document, where you learn how to enter customized IGBT data.

Considering the junction temperature ripple

The IGBT as well as the diode part of a module are conducting for 50% of the cycle-time of the sinusoidal output. Losses in these devices appear for one half-period, while the IGBT or diode in the opposite inverter position is not active. The junction temperature therefore oscillates with the output frequency.

There are three ways to implement its thermal calculation:

1) By just using the average losses P_{av} , we achieve an average junction temperature $T_{jav} = P_{av} \cdot R_{thjc}$. Due to the before mentioned ripple on the output, the peak value of the actual junction temperature will exceed the calculated T_{jav} .

2) A simple approach is to assume that the average losses P_{av} are dissipated in a rectangular shaped block of two times P_{av} during one half period of the phase current. Advantageously there exists a closed solution for such a periodic sequence of equally shaped pulses of period length T_0 :

$$\Delta T_j = 2 \cdot P_{av} \cdot \sum_i R_i \frac{1 - e^{-\frac{T_0/2}{\tau_i}}}{1 - e^{-\frac{T_0}{\tau_i}}}$$

The actual time-dependent losses in the device follow more or less the sinusoidal shape of the output current. An approximation of this shape by rectangular shaped blocks according to above formula is valid only for higher frequencies. The following example shows a comparison of the junction temperature rise for sinusoidal (blue) and rectangular (red) shaped power losses $p(t)$ at 50, 5 and 1 Hz respectively with the same value for the average power P_{av} .

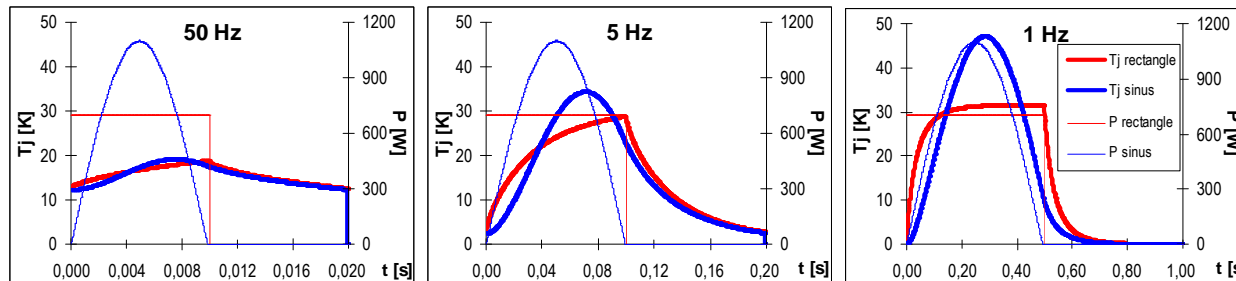

At 50 Hz, the junction temperatures for both curves behave quite similar. In the right 1 Hz figure it becomes obvious, that due to the low output frequency and its relation to the time constants of the transient thermal resistance junction-to-case Z_{thjc} , the temperature closely follows the shape of the loss curve. For sinusoidal losses, the simple rectangular approximation is not applicable any longer!

3) IPOSIM assumes a half-wave sinusoidal shape for the time dependency of the before discussed average power losses P_{av} . The distinct fluctuation of the junction temperature is considered properly.

Although the average losses P_{av} might be the same, the ripple and therefore the peak junction temperature increases at lower frequency and decreases with higher frequency. By changing the value of the output frequency on the sheets "autom. selection" or "selected module", the horizontal 'max. losses' lines in the "average losses vs. phase leg current" diagrams are adapted accordingly and are moving up or downwards.

Temperature distribution between junction and ambient

Considering the before calculated average losses vs. phase leg current and using the thermal model as shown in the chapter "module lead resistance", on sheet **"temperature distribution"** IPOSIM calculates the temperature drops across the three layers junction-to-case, case-to-heat sink and heat sink-to-ambient.

IGBT Power Simulation for Infineon IGBT modules V6.1a September 2006
module selection for 3-phase inverter applications

IPOSIM.PDF

Info



temperature distribution

selected module	FF800R17KE3	
simulation parameters:	temperature at I _{rms} = 500 A T _{jmax} [°C] 129,5 T _c [°C] 107,3 T _h [°C] 95,3 max. current for T _j < 125°C I _{rms} [A] 479,5	
DC link voltage V _{dc} [V]	900	
RMS current I _{rms} [A]	500	
frequency f ₀ [Hz]	50	
switching frequency f _{sw} [Hz]	2000	
max. junction temperature T _j [°C]	125	
modulation factor m	1,00	
cos φ	1,00	
R _{th} IGBT-junction to case [K/W]	0,028	<input checked="" type="radio"/> IGBT
R _{th} case to heat sink per arm [K/W]	0,012	<input type="radio"/> Diode

Please specify heat sink and ambient temperature in the green layered fields	application parameters:	
R _{th} heat sink per arm [K/W]	0,080	
max. ambient temperature T _a [°C]	40	40
static IGBT losses [W]	403	
dynamic IGBT losses [W]	293	Σ 696
static diode losses [W]	34	
dynamic diode losses [W]	136	Σ 170

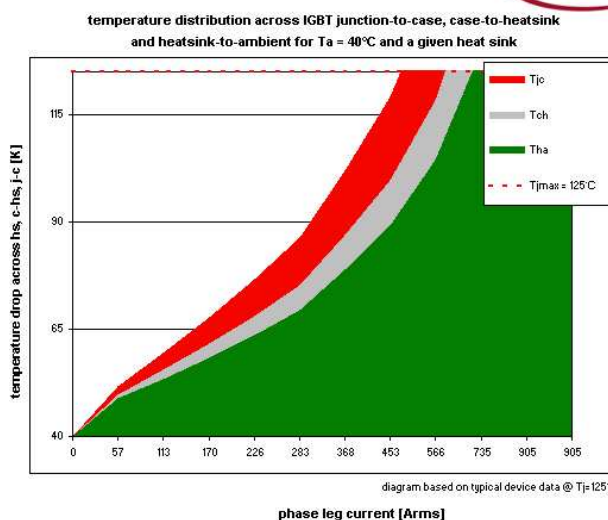

how to read the diagram:

The cross point between the max. junction temperature (dotted red line) and the red area delivers the highest allowed RMS phase leg current at the given operation and cooling conditions.

Enter the thermal resistance of your heat sink and the ambient temperature into the green layered fields. If heat sink values are not available yet, the following table will give you some benchmarks for different module housings and cooling conditions. IPOSIM itself will initialize the cell "R_{th} heat sink per arm" with a value according to following rule:

for Easy modules: $R_{th_{ha}} = 2 \times R_{th_{jh}}$

for all others: $R_{th_{ha}} = 5 \times R_{th_{ch}}$

You have to adjust this roughly estimated value for your specific application. An indication for typical ranges of R_{th_{ha}} values can be achieved from the following table.

module type	typical values for R _{th_{ha}} depending on module type		
	R _{th_{ch}} per module [K/W] typical values acc. to data sheet	R _{th_{ha}} per module [K/W]	
		water cooled (typ. 6-10 l/min)	forced air
Easy	0,37 - 0,22		0,8 - 0,4
EconoPACK™2	0,02		0,24 - 0,12
EconoPACK™3	0,012 - 0,011		0,12 - 0,06
62mm module	0,012 - 0,01		0,2 - 0,1
EconoPACK™+	0,005		0,05 - 0,025
140x130mm base plate	0,008 - 0,006	0,01 - 0,0065	0,05 - 0,028
140x190mm base plate	0,006 - 0,004	0,007 - 0,0045	0,04 - 0,02

For modules containing more than one single arm (e.g dual modules FF... or sixpacks FS...) the $R_{th_{ch}}$ values given in the module data sheet are aligned, so that the value shown in the corresponding yellow layered IPOSIM field reflect the "Rth case-to-heatsink *per arm*" for IGBT plus parallel diode. Below the two buttons, you find the separated pro-rata values for the IGBT and diode part. Be aware to do the same alignment – if necessary - for the heat sink (entering *per arm* values, while *per modules* values are given) when using above table.

After entering the correct thermal resistance of the heat sink and the boundary conditions for a maximum junction and ambient temperature are set, the blue layered fields deliver two informations: Firstly the temperatures of junction, case and heat sink for the pre-defined RMS current are given. These values may exceed the temperature limit of $T_{jmax}=125^{\circ}C$! Secondly the maximum current is calculated, which can be achieved when keeping the pre-defined maximum junction temperature limit.

By switching between the two IGBT / diode buttons (the active button is red-colored) you can perform the calculation for the IGBT as well as for the diode part of the module. In most cases, the highest temperatures for IGBTs will be reached in motor operation while diodes will reach highest temperatures in regenerative operation. Be aware that you do not change the $\cos \varphi$ when switching between the buttons ! Clicking the diode button for $\cos \varphi > 0$ will display the diode temperatures at motor operation, clicking the diode button for $\cos \varphi < 0$ will display the diode temperatures at regenerative operation.

Interpreting the diagram "temperature distribution across junction-to-case, case-to-heatsink, heatsink-to-ambient vs. phase leg current"

For a fixed maximum junction temperature as well as a maximum admissible ambient temperature the diagram will give the temperature distribution across the different layers junction-to-case, case-to-heatsink and heatsink-to-ambient versus different phase leg currents.

In the example below, the junction temperature (top line of the diagram) is set to 125°C and the ambient temperature (bottom line of the diagram) to 40°C. With the given module and operation conditions we get a maximum phase leg current of 479.5 Arms.

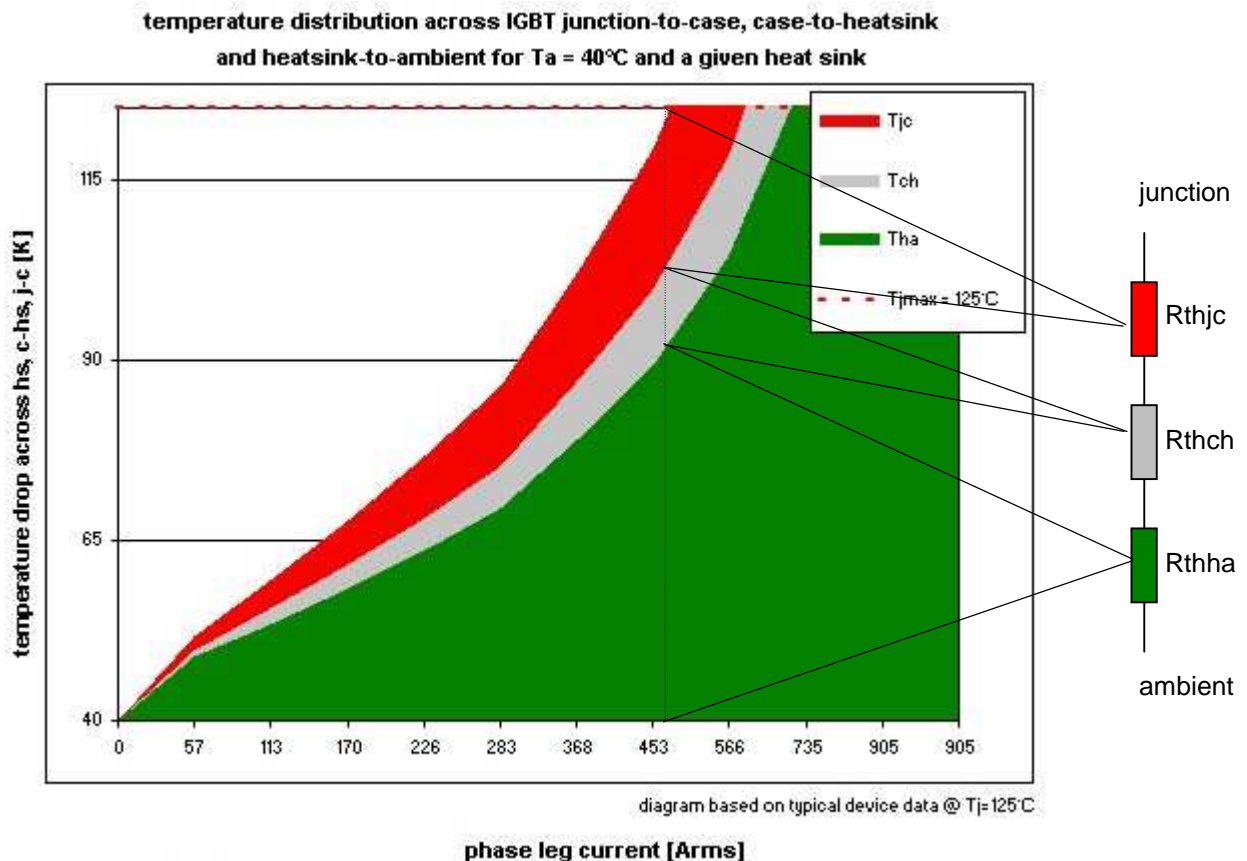

Compared to standard modules, which provide a large thermal capacity due to their integrated Cu or AISIC plate, the thermal dynamic behavior of Easy modules is different due to the lack of a base plate. To receive reliable simulation results, IPOSIM uses a R_{th} junction-to-heatsink, which considers the influence of different chip sizes and the heat spreading in the thermal interface. The R_{hjc} and R_{thch} layers are therefore consolidated for Easy modules.

Calculation of the junction temperature ripple

On sheet **“temperature ripple”**, you find the calculation of the steady state junction temperature for repetitive operation. The black curve (scaled on the left side of the diagram) represents the idealized sinusoidal run of the power losses, while the red curve (scaled on right) shows the resulting time dependent junction temperature during one cycle. As described before, IPOSIM regards this ripple when calculating the thermal limits for a given maximum junction temperature.

You may preview and print a result summary, showing the diagrams of sheets “select module”, “temperature distribution” and “temperature ripple” as well as the calculation inputs and results in tabular form by clicking on the button ‘print results’.

IGBT Power Simulation for Infineon IGBT modules V6.1a September 2006
module selection for 3-phase inverter applications

IPOSIM.PDF

Info

print results



junction temperature ripple

selected module

FF800R17KE3

simulation parameters:
 DC link voltage V_{dc} [V] **900**
 RMS current I_{rms} [A] **500**
 frequency f_0 [Hz] **50**
 switching frequency f_{sw} [Hz] **2000**
 max. junction temperature T_j [°C] **125**
 modulation factor m **1,00**
 $\cos \varphi$ **1,00**
 R_{th} IGBT-junction to case [K/W] **0,028**
 R_{th} case to heat sink per arm [K/W] **0,012**

application parameters:
 R_{th} heat sink per arm [K/W] **0,060**
 max. ambient temperature T_a [°C] **40**
 static IGBT losses [W] **403**
 dynamic IGBT losses [W] **293** Σ **696**
 static diode losses [W] **34**
 dynamic diode losses [W] **136** Σ **170**

temperature at

$I_{rms} = 500$ A

T_{jmax} [°C] **129,5**
 T_{jmin} [°C] **124,0**
 T_c [°C] **107,3**
 T_h [°C] **95,3**
 ripple ΔT_j [K] **5,5**

max. current for

$T_j < 125$ °C

I_{rms} [A] **479,5**

choose:

IGBT

Diode

losses and corresponding junction temperature ripple for the IGBT at $I_{rms} = 500$ A

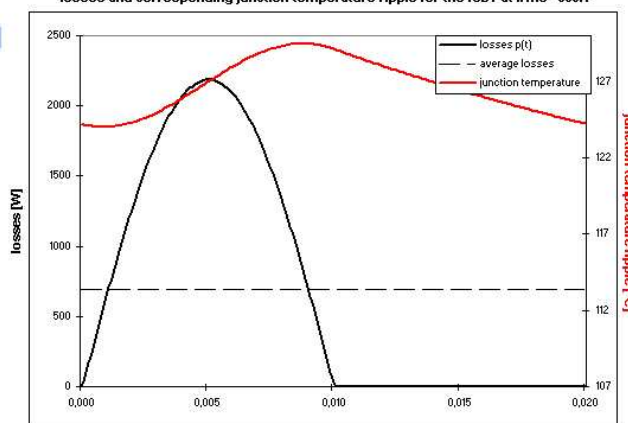

diagram based on typical device data @ $T_j = 125$ °C

one cycle of output frequency [s]

how to read the diagram:

The black curve shows the (assumed sinusoidal) losses, the red one the appearing ripple on the junction temperature under steady state conditions.

By switching between the two IGBT / diode buttons (the active button is red-colored) you can perform the calculation for the IGBT as well as for the diode part of the module. In most cases, the highest temperatures for IGBTs will be reached in motor operation while diodes will reach highest temperatures in regenerative operation. Be aware that you are not changing the $\cos \varphi$ when switching between these buttons ! Clicking the diode button for $\cos \varphi > 0$ will display the diode temperatures at motor operation, clicking the diode button for $\cos \varphi < 0$ will display the diode temperatures at regenerative operation.

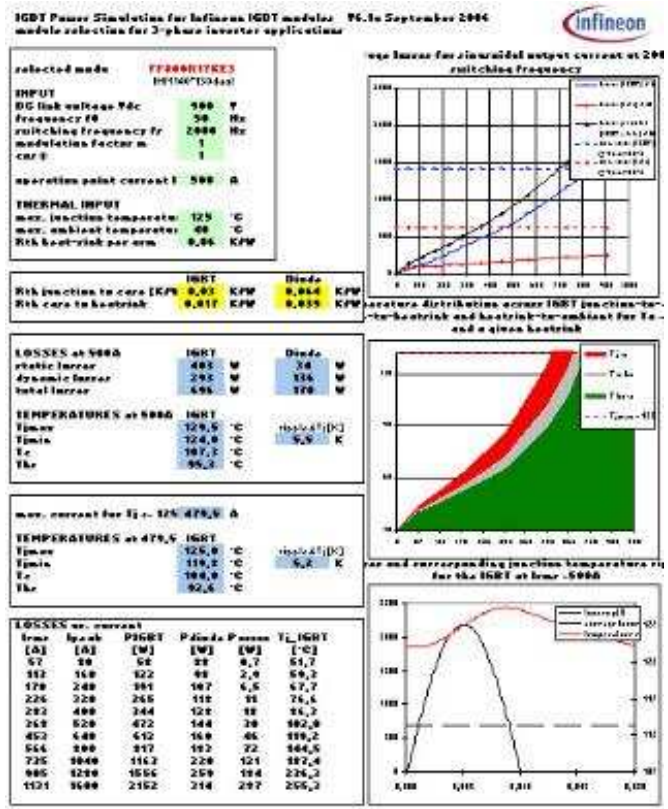

By pressing the button 'print results', you may print a result summary, which is showing the diagrams of the sheets "select module", "temperature distribution" and "temperature ripple" as well as the calculation inputs and results in tabular form.

Distribution of static and dynamic losses for IGBT and diode

The diagram from sheet "loss distribution" shows the spreading of IGBT (blue) or diode (red) total losses into a static and dynamic fraction.

IGBT Power Simulation for Infineon IGBT modules V6.1a September 2006
module selection for 3-phase inverter applications

IPOSIM.PDF Info



distribution of static and dynamic losses for IGBT and diode

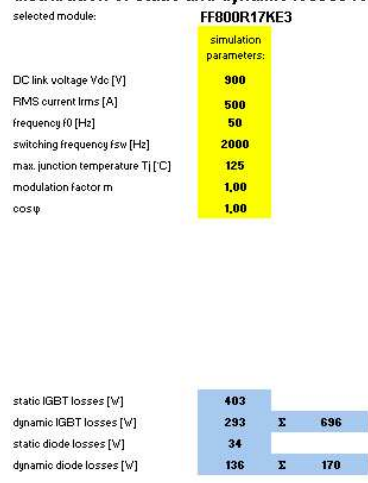

distribution of static and dynamic losses for IGBT and diode versus phase leg current

FF800R17KE3 at 900 V and 2000 Hz switching frequency

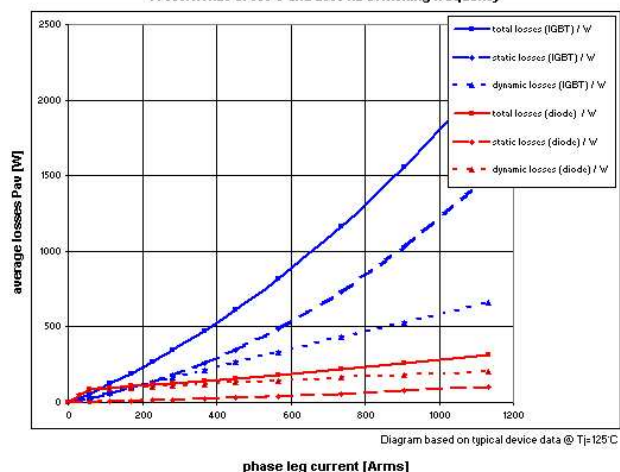

how to read the diagram:
 The diagram shows the spreading of IGBT (blue) or diode (red) total losses into a static and dynamic fraction.

Summary of the calculated results

On sheet **“results”** you find a summary of the calculated results. The input parameters, thermal limits and the numeric values for static and dynamic losses of IGBT and diode are given.

IGBT Power Simulation for Infineon IGBT modules V6.1a September 2006 selected module: FF800R17KE3



Module:		IGBT:				DIODE:				lead resistance:
I _{rms} [A]	I _{peak} [A]	P _{stat,I} [W]	E _{dyn,I} [W/s]	P _{dyn,I} [W]	PIGBT [W]	P _{stat,D} [W]	E _{dyn,D} [W/s]	P _{dyn,D} [W]	PDIODE [W]	P _{resistor} [W]
0	0	0	0	0	0	0	0	0	0	0
56,6	80	25,3	6,621E-01	33,1	58,4	2,9	1,705E+00	85,2	88,1	0,72
113,1	160	55,8	1,324E+00	66,2	122,0	6,0	1,833E+00	91,7	91,7	2,87
163,7	240	91,5	1,986E+00	99,3	190,8	9,4	1,962E+00	98,1	107,5	6,46
226,3	320	132,3	2,648E+00	132,4	264,8	13,0	2,031E+00	104,6	117,6	11,48
282,8	400	178,4	3,310E+00	165,5	343,9	16,9	2,220E+00	111,0	127,9	17,93
367,7	520	257,1	4,304E+00	215,2	472,3	23,2	2,414E+00	120,7	143,9	30,31
452,5	640	347,5	5,297E+00	264,8	612,3	30,1	2,607E+00	130,3	160,4	45,91
565,7	800	486,2	6,621E+00	331,0	817,2	40,2	2,865E+00	143,2	183,4	71,74
735,4	1040	733,0	8,607E+00	430,4	1163,3	57,2	3,252E+00	162,6	219,8	121,23
905,1	1280	1026,3	1,059E+01	529,7	1556,0	76,6	3,638E+00	181,9	258,5	183,64
1131,4	1600	1430,0	1,324E+01	662,1	2152,1	106,0	4,154E+00	207,7	313,7	286,94
500,0	707	403,1	5,852E+00	292,6	695,7	34,2	2,715E+00	135,8	163,9	56,04

see above cell for calculation of intermediate current values!

parameter input:	
DC link voltage V _{dc} [V]	900
RMS current I _{rms} [A]	500
frequency f ₀ [Hz]	50
switching frequency f _{sw} [Hz]	2000
junction temperature T _j [°C]	125
case temperature T _c [°C]	80
modulation factor m	1,00
cosφ	1,00

thermal limits:	
delta T [K]	45
R _{thj,c} [K/W]	0,028
P _{max,I} [W]	1408,8
R _{thj,c} [K/W]	0,064
P _{max,D} [W]	616,3

diagram 'average losses':					
I _{rms} [A]	PIGBT [W]	PDIODE [W]	P _{tot} [W]	P _{vmax,I} [W]	P _{vmax,D} [W]
0	0	0	0	1408,8	616,3
56,6	58,4	88,1	147,2	1408,8	616,3
113,1	122,0	91,7	222,5	1408,8	616,3
163,7	190,8	107,5	304,7	1408,8	616,3
226,3	264,8	117,6	393,8	1408,8	616,3
282,8	343,9	127,9	489,7	1408,8	616,3
367,7	472,3	143,9	646,5	1408,8	616,3
452,5	612,3	160,4	818,7	1408,8	616,3
565,7	817,2	183,4	1072,4	1408,8	616,3
735,4	1163,3	219,8	1504,4	1408,8	616,3
905,1	1556,0	258,5	1998,2	1408,8	616,3
905,1	1556,0	258,5	1998,2	1408,8	616,3

per switch:	
P _{tot} [W]	
0	
147,2	
222,5	
304,7	
393,8	
489,7	
646,5	
818,7	
1072,4	
1504,4	
1998,2	
2752,8	
321,7	

thermal resistances:	
R _{thh} [K/W]	0,06
R _{thc} [K/W]	0,012
R _{thc,I} [K/W]	0,01725
R _{thc,D} [K/W]	0,039429
T _a [°C]	40

diagram 'temperature distribution' (selected: IGBT):							
I _{rms} [A]	T _{jc} [K]	T _{ch} [K]	T _{ha} [K]	T _{amb} [°C]	T _j [°C]	T _{jmax} [°C]	ripple [K]
0,0	0,0	0,0	0,0	40	40,0	125	0,0
56,6	1,9	1,0	8,8	40	51,7	125	0,5
113,1	3,9	2,1	13,4	40	59,3	125	1,0
163,7	6,1	3,3	18,3	40	67,7	125	1,5
226,3	8,4	4,6	23,6	40	76,6	125	2,1
282,8	11,0	5,9	29,4	40	86,3	125	2,7
367,7	15,0	8,1	38,8	40	102,0	125	3,7
452,5	19,5	10,6	49,1	40	119,2	125	4,8
565,7	26,0	14,1	64,3	40	144,5	125	6,4
735,4	37,1	20,1	90,3	40	187,4	125	9,1
905,1	49,6	26,8	119,9	40	236,3	125	12,2
905,1	68,6	26,8	119,9	40	255,3	125	16,3
500,0	22,2	12,0	55,3	40	129,5	125	5,5

see above distribution for intermediate current values!

The green layered field offers the opportunity to enter intermediate current values and to let IPOSIM calculate the corresponding losses and temperatures at this specific operation point.

Calculation of custom specific load cycles

On sheet **“load cycle calculation”** IPOSIM offers the option to not only calculate losses and temperatures for single operation points but also for complete load cycles with sampling points of changing parameters. You can freely define application specific cycles with up to fifty sets of data. You may enter, save and later on restore and if necessary modify your cycles. The data will be stored in a file named **“IPOSIM load cycles.xls”**. The file has to be placed in the same directory as IPOSIM. Beside editing old or entering new data via IPOSIM, you may also directly edit the Excel file.

IGBT Power Simulation for Infineon IGBT modules V6.1a September 2006
module selection for 3-phase inverter applications

IPOSIM.PDF

Info



load cycle calculation

selected module FF800R17KE3
cycle name load cycle; FF800R17KE3
Rth heat sink per arm [K/W] 0,060
time const. tau heat sink [s] 30
number of points 8

Enter the parameters of a load cycle, which should be calculated for the selected module or click on the load button, to load an already saved cycle.

save

load

calculate

@ ambient temperature Ta=40°C

point #	point of time [s]	DC voltage [VDC]	motor voltage [Vrms]	motor current [Arms]	switching frequency [kHz]	output frequency [Hz]	cos φ	m	losses			IGBT		diode		
									IGBT [W]	diode [W]	total losses [W]	Th [°C]	Tc [°C]	Tj [°C]	Tc [°C]	Tj [°C]
1	0	900	0	400	4	0,0	1	0,0	628,2	381,3	1045,3	58,4	69,3	96,9	73,5	111,8
2	3	900	600	400	4	50	1	0,9	750,9	280,6	1067,3	62,7	75,7	99,6	73,8	94,4
3	3,1	900	600	250	4	50	1	0,9	439,8	232,5	686,2	62,8	70,4	88,3	72,0	90,4
4	13,1	900	600	250	4	50	1	0,9	439,8	232,5	686,2	68,0	75,6	89,6	77,2	94,1
5	13,2	900	600	400	4	50	-1	0,9	505,5	481,9	1023,3	68,1	76,8	92,1	87,1	115,1
6	15,2	900	0	400	4	50	-1	0,0	628,2	381,3	1045,3	70,3	81,1	101,1	85,3	113,4
7	15,3	900	0	0	4	0,0	1	0,0	0,0	0,0	0,0	70,2	70,2	85,7	70,2	91,9
8	30	900	0	0	4	0,0	1	0,0	0,0	0,0	0,0	58,5	58,5	58,5	58,5	58,5

Due to the steady state approach for the heat sink on sheets **“temperature distribution”** and **“temperature ripple”** there was no need to define its transient characteristic. Considering now fluctuating cycles in the time frame of seconds, a time constant tau for the heat sink, whose thermal resistance has already been entered on sheet **“temperature distribution”**, must be set.

IPOSIM assumes a periodic recurrence of the entered cycle. As long, as the time constant of the heat sink is in the regime of the length of the load cycle or below, the calculated heat sink temperature will be stable, means first and last point of the load cycle for T_n show the same value. If the time constant of the heat sink exceeds the cycle length, the calculation should be repeated, until a steady state, indicated by an identical heat sink temperature at start and end of the load cycle, has been reached.

When pushing the **‘calculate’** button (or when newly entering the worksheet) IPOSIM will check the input area for consistency and issue a warning if necessary. The number of sampling points for calculation will be derived by the duration of the load cycle and the smallest time step between the single points of time. You can reduce calculation time by avoiding to small time steps between two points. Depending on the resulting number of sampling points and speed of your PC, the following calculation will need some ten seconds up to a minute. Please be patient.

When entering new data, adhere strictly the following guide lines:

of points: Up to fifty sets of data are allowed. IPOSIM will use the entry of the field **‘number of points’** (cell C9) to save and calculate data lines. Update this field, when you have entered additional lines! The **‘save’** and **‘calculate’** button will not consider additional data beyond the value of C9.

point of time: The points of time have to start with **‘0’** and must be consistently rising. It is not necessary to have equidistant time steps.

DC voltage: Take care that the DC voltage complies with the recommended operation ranges for the different module voltage classes defined earlier in this document. Further on the DC voltage has to be > 0 , otherwise the modulation factor m can not be calculated.

motor voltage: The motor voltage can not exceed a value of $V_{rms} = 0.9 V_{DC}$. This corresponds with

$$\text{the maximum achievable value for } m: m = \frac{\hat{V}_{AC}}{V_{DC}} = \frac{\sqrt{2}V_{RMS}}{V_{DC}} \leq \frac{4}{\pi} \longrightarrow V_{RMS} \leq \frac{4}{\sqrt{2}\pi} V_{DC} \approx 0.9V_{DC}.$$

The resulting modulation factor will be calculated and shown in the table.

motor current: The motor peak current should not exceed the module's current limit of two times the nominal current.

output frequency: The operation at low frequencies results in extreme temperature ripples and could therefore drastically increases the peak junction temperature. Review properly operation points at or close to 0 Hz.

cos ϕ : The limits of $-1 \leq \cos \phi \leq 1$ must be obeyed.

On the succeeding sheet "**load cycle diagrams**" you find a graphic presentation of the input data, the calculated losses and resulting temperatures for IGBT, diode and heat sink.

IGBT Power Simulation for eupec IGBT modules V6.1a September 2006
module selection for 3-phase inverter applications

IPOSIM.PDF

Info



load cycle calculation

selected module **FF800R17KE3**
cycle name **load cycle; FF800R17KE3**
heat sink per arm Pth / tau **0,06 kW / 30s**

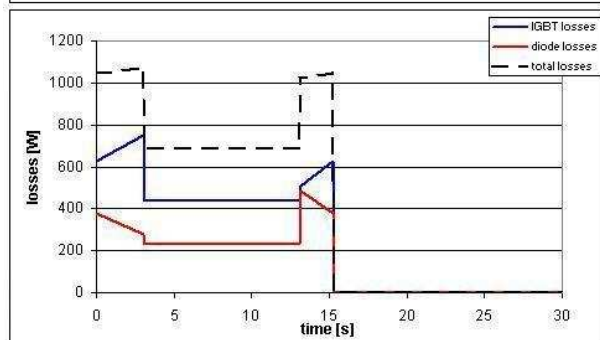
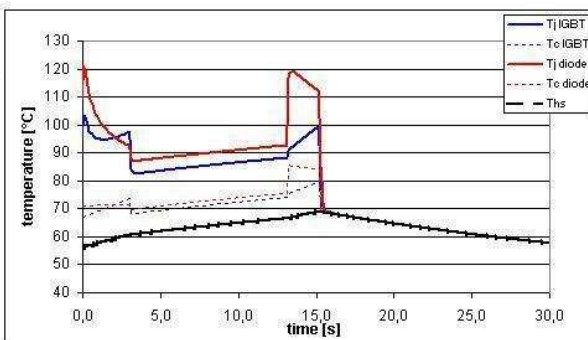
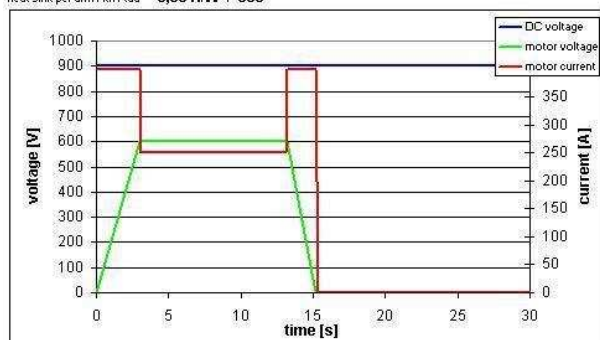

	Ta [°C]	Th [°C]	Tj IGBT [°C]	Tj diode [°C]
min		56,0	57,6	57,6
max	40,0	68,9	103,2	120,5
delta		12,8	45,6	62,9

Due to a certain lagging of the transient response of the heat sink you may find slight deviations between the maximum values given in the blue layered fields (representing the extreme values along the full cycle) and the highest T_j value calculated in the table on sheet "load cycle calculation" (representing the temperatures exactly at the given points of time). The worst case values are always given in this table.

How to enter your own IGBT data ?

On **sheet „values“** you find the IPOSIM data base. All module calculations are based on these data which reflect the data sheet version linked in column “AQ”.

The last five lines of the table are not write-protected. This offers you the opportunity to enter your own IGBT data. This could be desirable, if you use a different gate resistor (the required values for the switching losses can be read from the corresponding diagram in the Infineon data sheet) or if you have measured the switching losses by yourself.

New values should be entered according to the lines above in the following manner:

- No.: consecutive number; required
- IGBT type: e.g. FZxxxRxxKfx_modified
- housing type: input not required
- R_G [Ω]: value doesn't influence the calculation; input not required
- V_{DC} [V]: DC-link voltage used for characterization
- I_{nom} [A]: nominal module current

IGBT-parameters:

- R_{thjc} [K/W]: thermal resistance according to data sheet
- $V_{ce @ I_c}$ [V]: typ. saturation voltage; input not required
- E_{tot}/I_c [mWs/A]: normalized value of IGBT switching losses at nominal current: $(E_{on} + E_{off}) / I_c$
- V_{t02} [V] and R_{ce2} [Ω]: threshold voltage and slope of saturation voltage at 25°C
- V_{t01} [V] and R_{ce1} [Ω]: threshold voltage and slope of saturation voltage at 125°C

Diode parameters:

- R_{thjcd} [K/W]: thermal resistance according to data sheet
- Q_{rr2} [μ As] and Q_{rr1} [μ As]: recovery charge at 25°C and 125°C according to data sheet; these values will only be used, if no values for E_{rec} are given
- E_{rec2} [mWs] and E_{rec1} [mWs]: reverse recovery energy at 25°C and 125°C according to data sheet
- U_{02} [V] and R_{D2} [Ω]: threshold voltage and slope of forward voltage at 25°C
- U_{01} [V] and R_{D1} [Ω]: threshold voltage and slope of forward voltage at 125°C

Module parameters:

- $R_{CC'+EE'}$ [$m\Omega$]: module lead resistance according to data sheet
- R_{thch} [K/W]: thermal resistance case to heat sink; it has to be entered as a set of values $R_{thch,I}$ and $R_{thch,D}$ in the format “xxx / yyyy” for IGBT and diode *per arm*. If there is only one common $R_{thch,module}$ value available, the value has to be splitted into an IGBT and diode fraction (see application note 2004-01). Since this is a *per module* value, it has to be multiplied by the number of switches in the module (e.g. dual (FF) -> x2; sixpack (FS) -> x6) to get a *per arm* value. For baseplateless modules enter “0”.
- $T_{vjop,max=150^\circ C}$: Enter “150” for IGBT modules, which allow for a maximum operation temperature of 150°C
- Zth values: according to the values given in the data sheet
- data sheet link: input not required

X-ON Electronics

Largest Supplier of Electrical and Electronic Components

Click to view similar products for [Infineon](#) manufacturer:

Other Similar products are found below :

[BSM50GB60DLC](#) [DD260N12KHPSA1](#) [FF150R12MS4GBOSA1](#) [BTT6030-2EKA](#) [FD401R17KF6C_B2](#) [FF401R17KF6C_B2](#)
[SPW21N50C3](#) [IRFS31N20D](#) [XMC1100T038X0064AAXUMA1](#) [BUZ30AHXKSA1](#) [IRF2807](#) [SPA07N60CFD](#) [BTS442E2](#) [E3062A](#)
[SPP04N50C3XKSA1](#) [IRL2910](#) [IRFS52N15DHR](#) [BGA231N7E6327XTSA2](#) [IRGP20B60PD](#) [TDA21310XUSA1](#) [IRF7832](#) [IRF7422D2](#)
[IR3838MTRPBF](#) [IRF7301](#) [IDD05SG60C](#) [IRFR3518](#) [TLE4296G](#) [V30](#) [IRFZ24N](#) [IRFP260N](#) [IRF7316](#) [IFX25001TCV10ATMA1](#)
[TLE62512GXUMA1](#) [BSP299](#) [H6327](#) [IRFR3704](#) [IRLIZ44N](#) [IFX2931GV33XUMA1](#) [XMC1301T016X0016AAXUMA1](#)
[IPU60R2K0C6BKMA1](#) [IPP80N06S4L-07](#) [IPU60R1K4C6](#) [IRF7805](#) [IRLR8103V](#) [BSL802SNH6327XTSA1](#) [IRFR3910](#) [BTN7960B](#)
[IRFS59N10D](#) [IRFS59N10DTRR](#) [EVALM113023645ATOBO1](#) [EVALM11302TOBO1](#) [FD1000R33HE3-K](#) [FF1200R17KE3_B2](#)