

62mm C-Serien Modul mit Trench/Feldstopp IGBT4 und Emitter Controlled 3 Diode
62mm C-Series module with Trench/Fieldstop IGBT4 and Emitter Controlled 3 diode

Vorläufige Daten / Preliminary Data

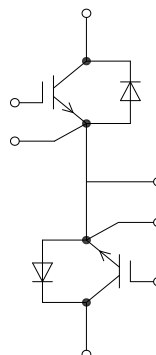
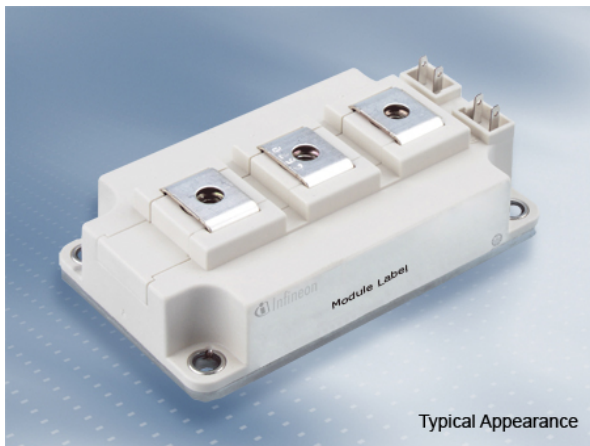

$V_{CES} = 1700V$
 $I_{C\ nom} = 400A / I_{CRM} = 800A$

Typische Anwendungen

- Hochleistungsumrichter
- Motorantriebe
- USV-Systeme
- Windgeneratoren

Typical Applications

- High power converters
- Motor drives
- UPS systems
- Wind turbines

Elektrische Eigenschaften

- Erweiterte Sperrschichttemperatur $T_{vj\ op}$
- Niedriges V_{CESat}
- Sehr große Robustheit
- V_{CESat} mit positivem Temperaturkoeffizienten

Electrical Features

- Extended operating temperature $T_{vj\ op}$
- Low V_{CESat}
- Unbeatable robustness
- V_{CESat} with positive temperature coefficient

Mechanische Eigenschaften

- 4 kV AC 1min Isolationsfestigkeit
- Gehäuse mit CTI > 400
- Große Luft- und Kriechstrecken
- Isolierte Bodenplatte
- Standardgehäuse

Mechanical Features

- 4 kV AC 1min insulation
- Package with CTI > 400
- High creepage and clearance distances
- Isolated base plate
- Standard housing

Module Label Code

Barcode Code 128



DMX - Code



Content of the Code

	Digit
Module Serial Number	1 - 5
Module Material Number	6 - 11
Production Order Number	12 - 19
Datecode (Production Year)	20 - 21
Datecode (Production Week)	22 - 23

prepared by: AKB	date of publication: 2016-07-15	
approved by: MK	revision: V2.0	UL approved (E83335)



**Vorläufige Daten
Preliminary Data**

**IGBT, Wechselrichter / IGBT, Inverter
Höchstzulässige Werte / Maximum Rated Values**

Kollektor-Emitter-Sperrspannung Collector-emitter voltage	$T_{vj} = 25^{\circ}\text{C}$	V_{CES}	1700	V
Kollektor-Dauergleichstrom Continuous DC collector current	$T_C = 95^{\circ}\text{C}, T_{vj\text{ max}} = 175^{\circ}\text{C}$	$I_{C\text{ nom}}$	400	A
Periodischer Kollektor-Spitzenstrom Repetitive peak collector current	$t_P = 1\text{ ms}$	I_{CRM}	800	A
Gate-Emitter-Spitzenspannung Gate-emitter peak voltage		V_{GES}	+/-20	V

Charakteristische Werte / Characteristic Values

			min.	typ.	max.	
Kollektor-Emitter-Sättigungsspannung Collector-emitter saturation voltage	$I_C = 400\text{ A}, V_{GE} = 15\text{ V}$ $I_C = 400\text{ A}, V_{GE} = 15\text{ V}$ $I_C = 400\text{ A}, V_{GE} = 15\text{ V}$	$T_{vj} = 25^{\circ}\text{C}$ $T_{vj} = 125^{\circ}\text{C}$ $T_{vj} = 150^{\circ}\text{C}$	$V_{CE\text{ sat}}$	1,95 2,35 2,45	2,30	V V V
Gate-Schwellenspannung Gate threshold voltage	$I_C = 16,0\text{ mA}, V_{CE} = V_{GE}, T_{vj} = 25^{\circ}\text{C}$		V_{GEth}	5,35	5,80	6,25 V
Gateladung Gate charge	$V_{GE} = -15\text{ V} \dots +15\text{ V}$		Q_G	4,10		μC
Interner Gatewiderstand Internal gate resistor	$T_{vj} = 25^{\circ}\text{C}$		R_{Gint}	1,9		Ω
Eingangskapazität Input capacitance	$f = 1\text{ MHz}, T_{vj} = 25^{\circ}\text{C}, V_{CE} = 25\text{ V}, V_{GE} = 0\text{ V}$		C_{ies}	36,0		nF
Rückwirkungskapazität Reverse transfer capacitance	$f = 1\text{ MHz}, T_{vj} = 25^{\circ}\text{C}, V_{CE} = 25\text{ V}, V_{GE} = 0\text{ V}$		C_{res}	1,15		nF
Kollektor-Emitter-Reststrom Collector-emitter cut-off current	$V_{CE} = 1700\text{ V}, V_{GE} = 0\text{ V}, T_{vj} = 25^{\circ}\text{C}$		I_{CES}		1,0	mA
Gate-Emitter-Reststrom Gate-emitter leakage current	$V_{CE} = 0\text{ V}, V_{GE} = 20\text{ V}, T_{vj} = 25^{\circ}\text{C}$		I_{GES}		400	nA
Einschaltverzögerungszeit, induktive Last Turn-on delay time, inductive load	$I_C = 400\text{ A}, V_{CE} = 900\text{ V}$ $V_{GE} = \pm 15\text{ V}$ $R_{Gon} = 0,82\ \Omega$	$T_{vj} = 25^{\circ}\text{C}$ $T_{vj} = 125^{\circ}\text{C}$ $T_{vj} = 150^{\circ}\text{C}$	t_{don}	0,24 0,26 0,27		μs μs μs
Anstiegszeit, induktive Last Rise time, inductive load	$I_C = 400\text{ A}, V_{CE} = 900\text{ V}$ $V_{GE} = \pm 15\text{ V}$ $R_{Gon} = 0,82\ \Omega$	$T_{vj} = 25^{\circ}\text{C}$ $T_{vj} = 125^{\circ}\text{C}$ $T_{vj} = 150^{\circ}\text{C}$	t_r	0,04 0,05 0,05		μs μs μs
Abschaltverzögerungszeit, induktive Last Turn-off delay time, inductive load	$I_C = 400\text{ A}, V_{CE} = 900\text{ V}$ $V_{GE} = \pm 15\text{ V}$ $R_{Goff} = 0,82\ \Omega$	$T_{vj} = 25^{\circ}\text{C}$ $T_{vj} = 125^{\circ}\text{C}$ $T_{vj} = 150^{\circ}\text{C}$	t_{doff}	0,50 0,64 0,68		μs μs μs
Fallzeit, induktive Last Fall time, inductive load	$I_C = 400\text{ A}, V_{CE} = 900\text{ V}$ $V_{GE} = \pm 15\text{ V}$ $R_{Goff} = 0,82\ \Omega$	$T_{vj} = 25^{\circ}\text{C}$ $T_{vj} = 125^{\circ}\text{C}$ $T_{vj} = 150^{\circ}\text{C}$	t_f	0,09 0,15 0,17		μs μs μs
Einschaltverlustenergie pro Puls Turn-on energy loss per pulse	$I_C = 400\text{ A}, V_{CE} = 900\text{ V}, L_S = 35\text{ nH}$ $V_{GE} = \pm 15\text{ V}, di/dt = 8000\text{ A}/\mu\text{s} (T_{vj} = 150^{\circ}\text{C})$ $R_{Gon} = 0,82\ \Omega$	$T_{vj} = 25^{\circ}\text{C}$ $T_{vj} = 125^{\circ}\text{C}$ $T_{vj} = 150^{\circ}\text{C}$	E_{on}	89,0 125 140		mJ mJ mJ
Abschaltverlustenergie pro Puls Turn-off energy loss per pulse	$I_C = 400\text{ A}, V_{CE} = 900\text{ V}, L_S = 35\text{ nH}$ $V_{GE} = \pm 15\text{ V}, du/dt = 3200\text{ V}/\mu\text{s} (T_{vj} = 150^{\circ}\text{C})$ $R_{Goff} = 0,82\ \Omega$	$T_{vj} = 25^{\circ}\text{C}$ $T_{vj} = 125^{\circ}\text{C}$ $T_{vj} = 150^{\circ}\text{C}$	E_{off}	73,0 120 130		mJ mJ mJ
Kurzschlußverhalten SC data	$V_{GE} \leq 15\text{ V}, V_{CC} = 1000\text{ V}$ $V_{CE\text{ max}} = V_{CES} - L_{SCE} \cdot di/dt$ $t_P \leq 10\ \mu\text{s}, T_{vj} = 150^{\circ}\text{C}$		I_{SC}	1800		A
Wärmewiderstand, Chip bis Gehäuse Thermal resistance, junction to case	pro IGBT / per IGBT		R_{thJC}		0,0632	K/W
Wärmewiderstand, Gehäuse bis Kühlkörper Thermal resistance, case to heatsink	pro IGBT / per IGBT $\lambda_{\text{Paste}} = 1\text{ W}/(\text{m}\cdot\text{K}) / \lambda_{\text{grease}} = 1\text{ W}/(\text{m}\cdot\text{K})$		R_{thCH}	0,0271		K/W
Temperatur im Schaltbetrieb Temperature under switching conditions			$T_{vj\text{ op}}$	-40	150	$^{\circ}\text{C}$

prepared by: AKB	date of publication: 2016-07-15
approved by: MK	revision: V2.0



**Vorläufige Daten
Preliminary Data**

Diode, Wechselrichter / Diode, Inverter

Höchstzulässige Werte / Maximum Rated Values

Periodische Spitzensperrspannung Repetitive peak reverse voltage	$T_{vj} = 25^{\circ}\text{C}$	V_{RRM}	1700	V
Dauergleichstrom Continuous DC forward current		I_F	400	A
Periodischer Spitzenstrom Repetitive peak forward current	$t_P = 1\text{ ms}$	I_{FRM}	800	A
Grenzlastintegral I^2t - value	$V_R = 0\text{ V}, t_P = 10\text{ ms}, T_{vj} = 125^{\circ}\text{C}$ $V_R = 0\text{ V}, t_P = 10\text{ ms}, T_{vj} = 150^{\circ}\text{C}$	I^2t	33000 28500	A^2s A^2s

Charakteristische Werte / Characteristic Values

			min.	typ.	max.	
Durchlassspannung Forward voltage	$I_F = 400\text{ A}, V_{GE} = 0\text{ V}$ $I_F = 400\text{ A}, V_{GE} = 0\text{ V}$ $I_F = 400\text{ A}, V_{GE} = 0\text{ V}$	$T_{vj} = 25^{\circ}\text{C}$ $T_{vj} = 125^{\circ}\text{C}$ $T_{vj} = 150^{\circ}\text{C}$	V_F	1,80 1,90 1,95	2,20	V V V
Rückstromspitze Peak reverse recovery current	$I_F = 400\text{ A}, -di_F/dt = 8000\text{ A}/\mu\text{s} (T_{vj}=150^{\circ}\text{C})$ $V_R = 900\text{ V}$ $V_{GE} = -15\text{ V}$	$T_{vj} = 25^{\circ}\text{C}$ $T_{vj} = 125^{\circ}\text{C}$ $T_{vj} = 150^{\circ}\text{C}$	I_{RM}	605 630 640		A A A
Sperrverzögerungsladung Recovered charge	$I_F = 400\text{ A}, -di_F/dt = 8000\text{ A}/\mu\text{s} (T_{vj}=150^{\circ}\text{C})$ $V_R = 900\text{ V}$ $V_{GE} = -15\text{ V}$	$T_{vj} = 25^{\circ}\text{C}$ $T_{vj} = 125^{\circ}\text{C}$ $T_{vj} = 150^{\circ}\text{C}$	Q_r	105 170 190		μC μC μC
Abschaltenergie pro Puls Reverse recovery energy	$I_F = 400\text{ A}, -di_F/dt = 8000\text{ A}/\mu\text{s} (T_{vj}=150^{\circ}\text{C})$ $V_R = 900\text{ V}$ $V_{GE} = -15\text{ V}$	$T_{vj} = 25^{\circ}\text{C}$ $T_{vj} = 125^{\circ}\text{C}$ $T_{vj} = 150^{\circ}\text{C}$	E_{rec}	55,5 97,0 110		mJ mJ mJ
Wärmewiderstand, Chip bis Gehäuse Thermal resistance, junction to case	pro Diode / per diode		R_{thJC}		0,106	K/W
Wärmewiderstand, Gehäuse bis Kühlkörper Thermal resistance, case to heatsink	pro Diode / per diode $\lambda_{Paste} = 1\text{ W}/(\text{m}\cdot\text{K})$ / $\lambda_{grease} = 1\text{ W}/(\text{m}\cdot\text{K})$		R_{thCH}	0,0260		K/W
Temperatur im Schaltbetrieb Temperature under switching conditions			$T_{vj\text{ op}}$	-40	150	$^{\circ}\text{C}$

prepared by: AKB	date of publication: 2016-07-15
approved by: MK	revision: V2.0



**Vorläufige Daten
Preliminary Data**

Modul / Module

Isolations-Prüfspannung Isolation test voltage	RMS, f = 50 Hz, t = 1 min.	V _{ISOL}	4,0		kV
Material Modulgrundplatte Material of module baseplate			Cu		
Innere Isolation Internal isolation	Basisisolierung (Schutzklasse 1, EN61140) basic insulation (class 1, IEC 61140)		Al ₂ O ₃		
Kriechstrecke Creepage distance	Kontakt - Kühlkörper / terminal to heatsink Kontakt - Kontakt / terminal to terminal		29,0 23,0		mm
Luftstrecke Clearance	Kontakt - Kühlkörper / terminal to heatsink Kontakt - Kontakt / terminal to terminal		23,0 11,0		mm
Vergleichszahl der Kriechwegbildung Comperative tracking index		CTI	> 400		
			min.	typ.	max.
Modulstreuintuktivität Stray inductance module		L _{sCE}		20	nH
Modulleitungswiderstand, Anschlüsse - Chip Module lead resistance, terminals - chip	T _C = 25°C, pro Schalter / per switch	R _{CC'+EE'}		0,41	mΩ
Lagertemperatur Storage temperature		T _{stg}	-40		125 °C
Anzugsdrehmoment f. Modulmontage Mounting torque for modul mounting	Schraube M6 - Montage gem. gültiger Applikationsschrift Screw M6 - Mounting according to valid application note	M	3,00		6,00 Nm
Anzugsdrehmoment f. elektr. Anschlüsse Terminal connection torque	Schraube M6 - Montage gem. gültiger Applikationsschrift Screw M6 - Mounting according to valid application note	M	2,5	-	5,0 Nm
Gewicht Weight		G		340	g

prepared by: AKB	date of publication: 2016-07-15
approved by: MK	revision: V2.0

Vorläufige Daten
Preliminary Data

Ausgangskennlinie IGBT, Wechselrichter (typisch)
output characteristic IGBT, Inverter (typical)

$I_C = f(V_{CE})$
 $V_{GE} = 15\text{ V}$

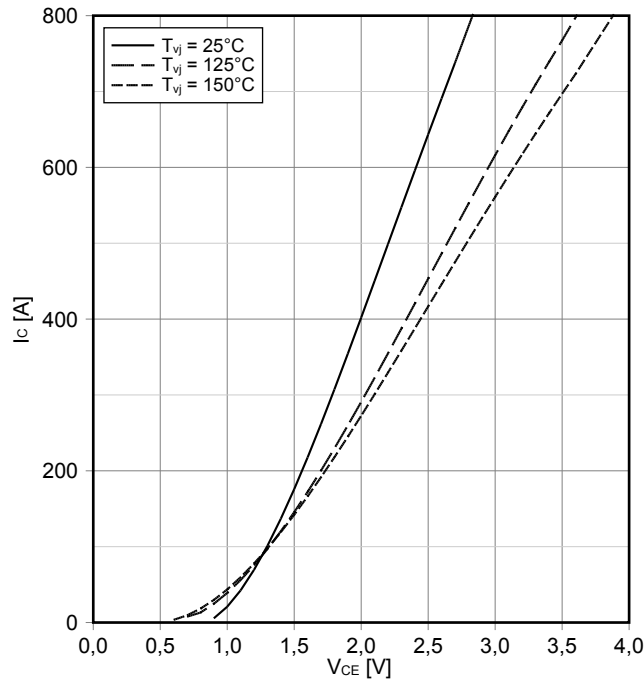

Ausgangskennlinienfeld IGBT, Wechselrichter (typisch)
output characteristic IGBT, Inverter (typical)

$I_C = f(V_{CE})$
 $T_{vj} = 150^\circ\text{C}$

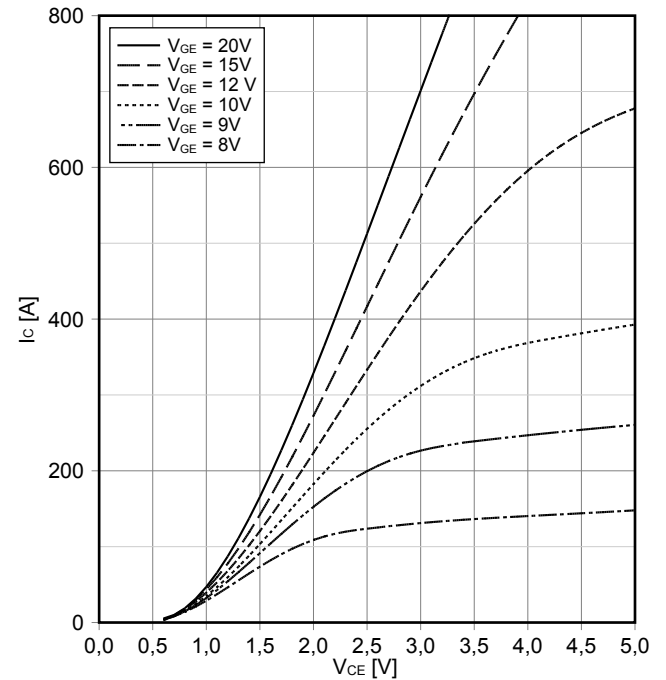

Übertragungscharakteristik IGBT, Wechselrichter (typisch)
transfer characteristic IGBT, Inverter (typical)

$I_C = f(V_{GE})$
 $V_{CE} = 20\text{ V}$

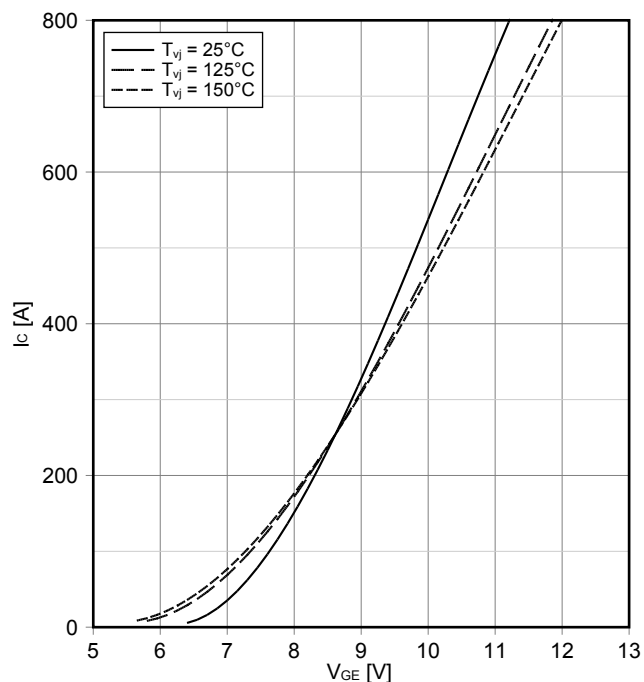

Schaltverluste IGBT, Wechselrichter (typisch)
switching losses IGBT, Inverter (typical)

$E_{on} = f(I_C)$, $E_{off} = f(I_C)$
 $V_{GE} = \pm 15\text{ V}$, $R_{Gon} = 0.82\ \Omega$, $R_{Goff} = 0.82\ \Omega$, $V_{CE} = 900\text{ V}$

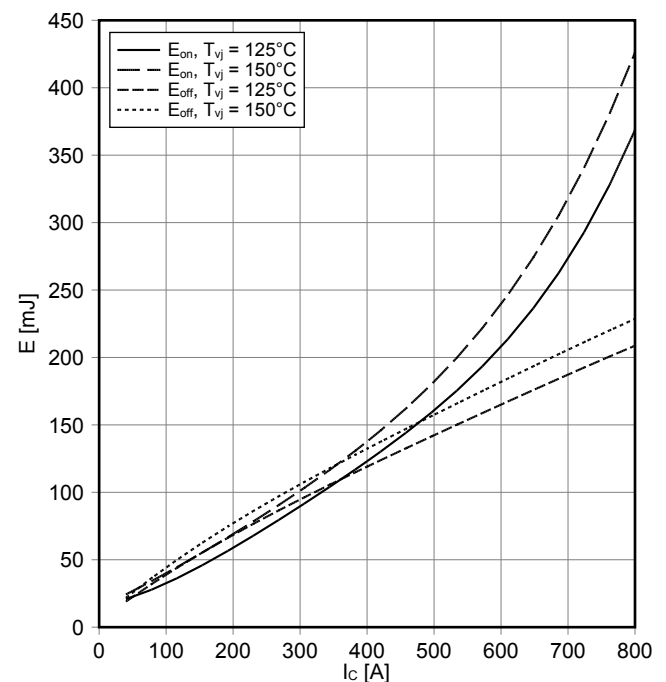

prepared by: AKB	date of publication: 2016-07-15
approved by: MK	revision: V2.0



**Vorläufige Daten
Preliminary Data**

**Schaltverluste IGBT, Wechselrichter (typisch)
switching losses IGBT, Inverter (typical)**

$E_{on} = f(R_G)$, $E_{off} = f(R_G)$
 $V_{GE} = \pm 15\text{ V}$, $I_C = 400\text{ A}$, $V_{CE} = 900\text{ V}$

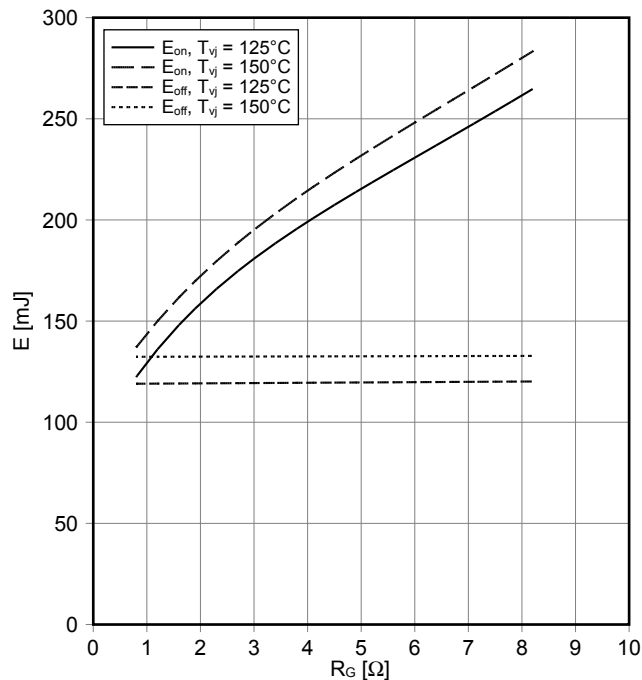

**Transienter Wärmewiderstand IGBT, Wechselrichter
transient thermal impedance IGBT, Inverter**

$Z_{thJC} = f(t)$

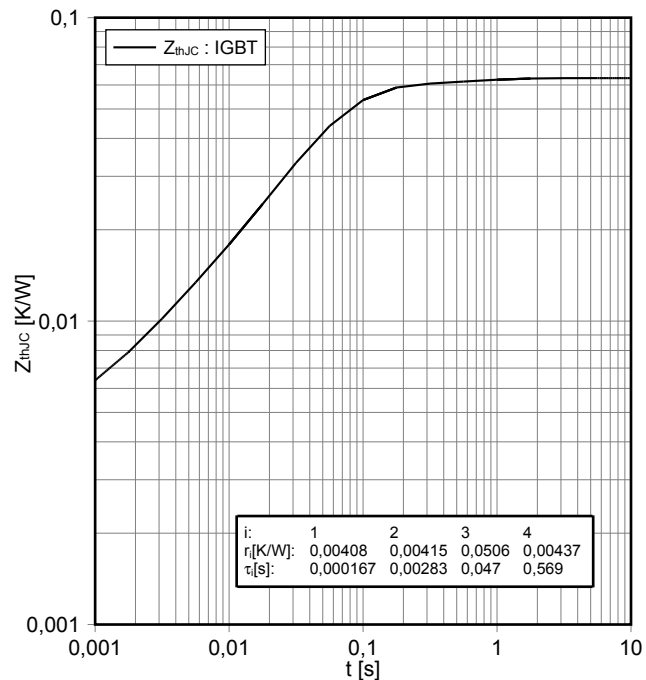

**Sicherer Rückwärts-Arbeitsbereich IGBT, Wechselrichter
(RBSOA)**

reverse bias safe operating area IGBT, Inverter (RBSOA)

$I_C = f(V_{CE})$
 $V_{GE} = \pm 15\text{ V}$, $R_{Goff} = 0.82\ \Omega$, $T_{vj} = 150^\circ\text{C}$

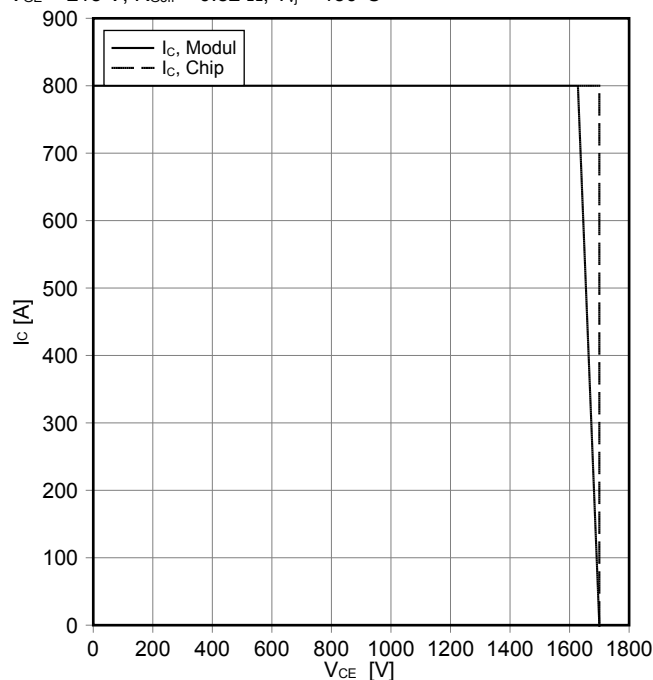

**Durchlasskennlinie der Diode, Wechselrichter (typisch)
forward characteristic of Diode, Inverter (typical)**

$I_F = f(V_F)$

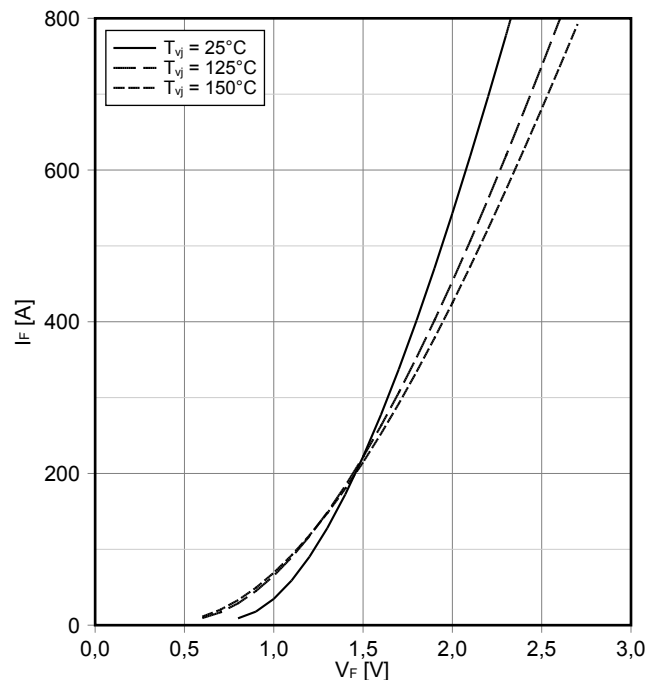

prepared by: AKB	date of publication: 2016-07-15
approved by: MK	revision: V2.0



Vorläufige Daten
Preliminary Data

Schaltverluste Diode, Wechselrichter (typisch)
switching losses Diode, Inverter (typical)

$E_{rec} = f(I_F)$
 $R_{Gon} = 0.82 \Omega, V_{CE} = 900 V$

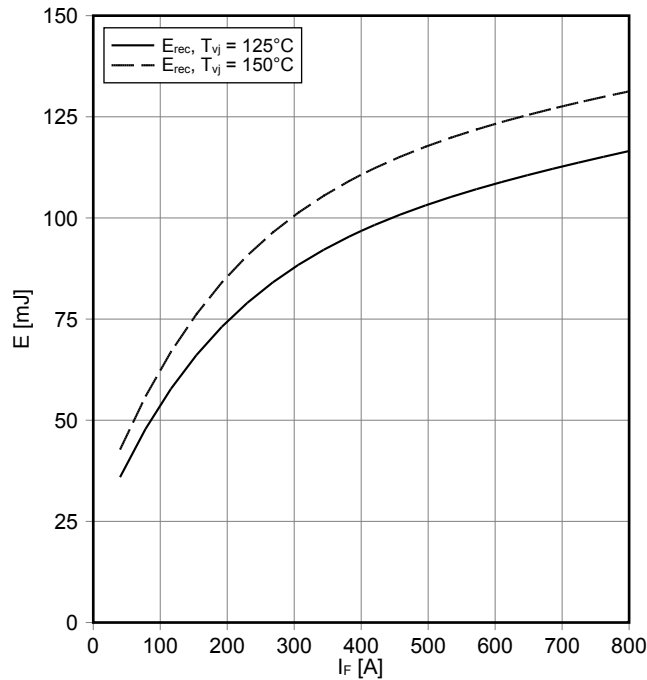

Schaltverluste Diode, Wechselrichter (typisch)
switching losses Diode, Inverter (typical)

$E_{rec} = f(R_G)$
 $I_F = 400 A, V_{CE} = 900 V$

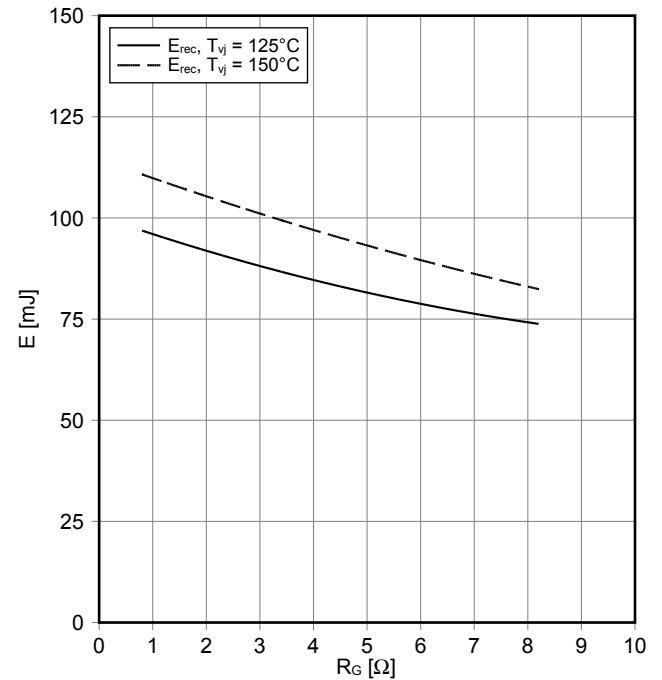

Transienter Wärmewiderstand Diode, Wechselrichter
transient thermal impedance Diode, Inverter

$Z_{thJC} = f(t)$

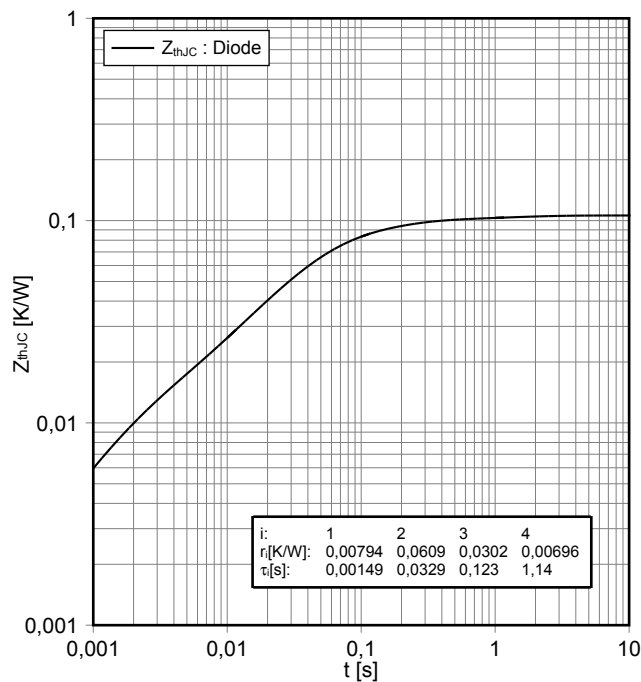

prepared by: AKB	date of publication: 2016-07-15
approved by: MK	revision: V2.0

Vorläufige Daten
Preliminary Data

Schaltplan / Circuit diagram

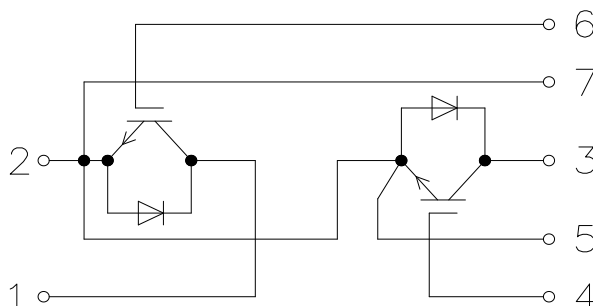

Gehäuseabmessungen / Package outlines

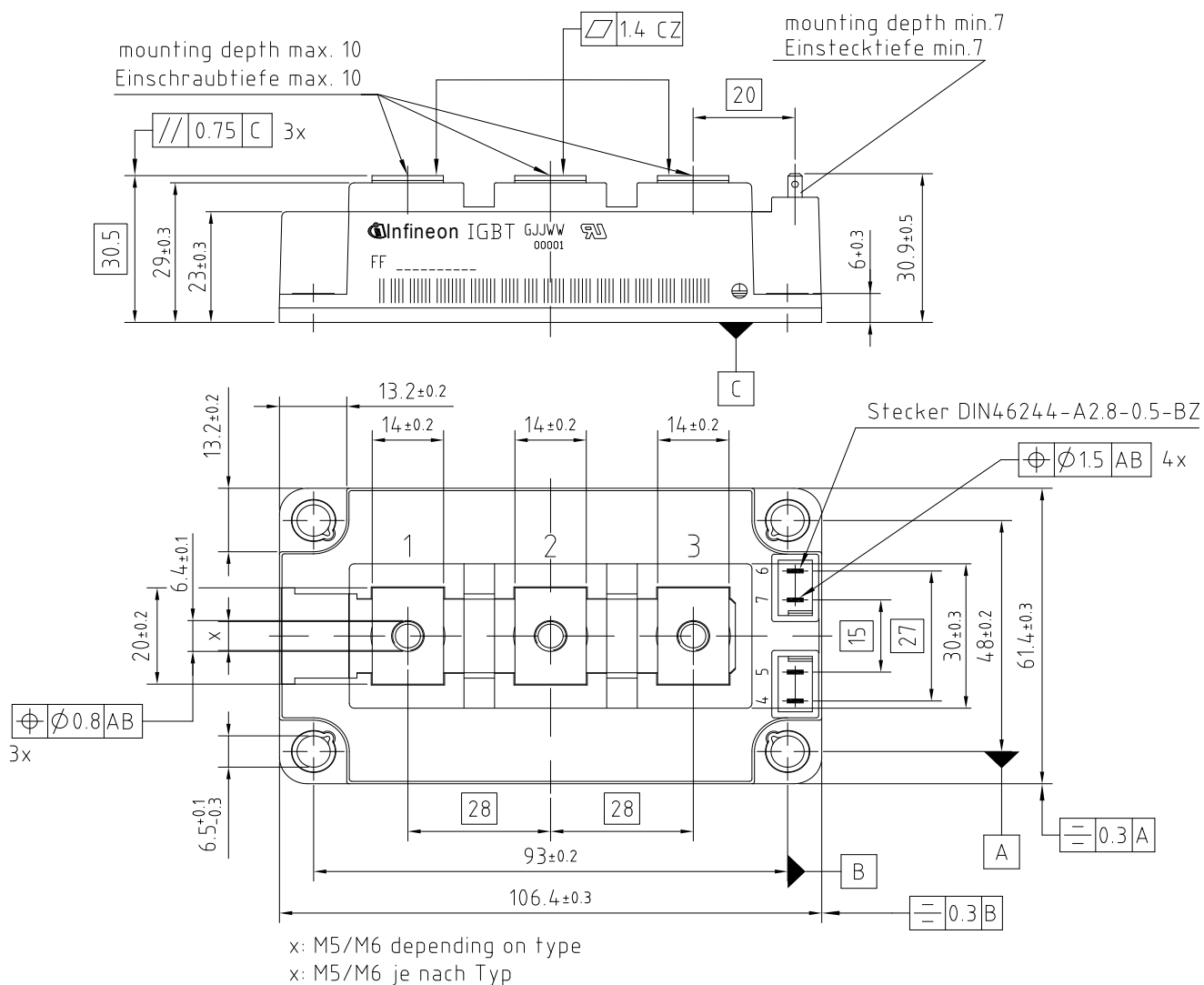

prepared by: AKB	date of publication: 2016-07-15
approved by: MK	revision: V2.0



Vorläufige Daten Preliminary Data

Published by
Infineon Technologies AG
81726 München, Germany
© Infineon Technologies AG 2015.
All Rights Reserved.

Nutzungsbedingungen

WICHTIGER HINWEIS

Die in diesem Dokument enthaltenen Angaben stellen keinesfalls Garantien für die Beschaffenheit oder Eigenschaften des Produktes ("Beschaffensgarantie") dar. Für Beispiele, Hinweise oder typische Werte, die in diesem Dokument enthalten sind, und/oder Angaben, die sich auf die Anwendung des Produktes beziehen, ist jegliche Gewährleistung und Haftung von Infineon Technologies ausgeschlossen, einschließlich, ohne hierauf beschränkt zu sein, die Gewähr dafür, dass kein geistiges Eigentum Dritter verletzt ist.

Des Weiteren stehen sämtliche, in diesem Dokument enthaltenen Informationen, unter dem Vorbehalt der Einhaltung der in diesem Dokument festgelegten Verpflichtungen des Kunden sowie aller im Hinblick auf das Produkt des Kunden sowie die Nutzung des Infineon Produktes in den Anwendungen des Kunden anwendbaren gesetzlichen Anforderungen, Normen und Standards durch den Kunden.

Die in diesem Dokument enthaltenen Daten sind ausschließlich für technisch geschultes Fachpersonal bestimmt. Die Beurteilung der Eignung dieses Produktes für die beabsichtigte Anwendung sowie die Beurteilung der Vollständigkeit der in diesem Dokument enthaltenen Produktdaten für diese Anwendung obliegt den technischen Fachabteilungen des Kunden.

Sollten Sie von uns weitere Informationen im Zusammenhang mit dem Produkt, der Technologie, Lieferbedingungen bzw. Preisen benötigen, wenden Sie sich bitte an das nächste Vertriebsbüro von Infineon Technologies (www.infineon.com).

WARNHINWEIS

Aufgrund der technischen Anforderungen können Produkte gesundheitsgefährdende Substanzen enthalten. Bei Fragen zu den in diesem Produkt enthaltenen Substanzen, setzen Sie sich bitte mit dem nächsten Vertriebsbüro von Infineon Technologies in Verbindung.

Sofern Infineon Technologies nicht ausdrücklich in einem schriftlichen, von vertretungsberechtigten Infineon Mitarbeitern unterzeichneten Dokument zugestimmt hat, dürfen Produkte von Infineon Technologies nicht in Anwendungen eingesetzt werden, in welchen vernünftigerweise erwartet werden kann, dass ein Fehler des Produktes oder die Folgen der Nutzung des Produktes zu Personenverletzungen führen.

Terms & Conditions of usage

IMPORTANT NOTICE

The information given in this document shall in no event be regarded as a guarantee of conditions or characteristics ("Beschaffensgarantie"). With respect to any examples, hints or any typical values stated herein and/or any information regarding the application of the product, Infineon Technologies hereby disclaims any and all warranties and liabilities of any kind, including without limitation warranties of non-infringement of intellectual property rights of any third party.

In addition, any information given in this document is subject to customer's compliance with its obligations stated in this document and any applicable legal requirements, norms and standards concerning customer's products and any use of the product of Infineon Technologies in customer's applications.

The data contained in this document is exclusively intended for technically trained staff. It is the responsibility of customer's technical departments to evaluate the suitability of the product for the intended application and the completeness of the product information given in this document with respect to such application.

For further information on the product, technology, delivery terms and conditions and prices please contact your nearest Infineon Technologies office (www.infineon.com).

WARNINGS

Due to technical requirements products may contain dangerous substances. For information on the types in question please contact your nearest Infineon Technologies office.

Except as otherwise explicitly approved by Infineon Technologies in a written document signed by authorized representatives of Infineon Technologies, Infineon Technologies' products may not be used in any applications where a failure of the product or any consequences of the use thereof can reasonably be expected to result in personal injury.

prepared by: AKB	date of publication: 2016-07-15
approved by: MK	revision: V2.0

X-ON Electronics

Largest Supplier of Electrical and Electronic Components

Click to view similar products for [IGBT Modules category](#):

Click to view products by [Infineon manufacturer](#):

Other Similar products are found below :

[F3L400R07ME4_B22](#) [F4-50R07W2H3_B51](#) [FB15R06W1E3](#) [FB20R06W1E3_B11](#) [FD1000R33HE3-K](#) [FD400R33KF2C-K](#)
[FD401R17KF6C_B2](#) [FD-DF80R12W1H3_B52](#) [FF200R06YE3](#) [FF300R12KE4_E](#) [FF450R12ME4P](#) [FF600R12IP4V](#) [FP10R06W1E3_B11](#)
[FP20R06W1E3](#) [FP50R12KT3](#) [FP75R07N2E4_B11](#) [FS10R12YE3](#) [FS150R07PE4](#) [FS150R12PT4](#) [FS50R07N2E4_B11](#) [FZ1000R33HE3](#)
[FZ1800R17KF4](#) [DD250S65K3](#) [DF1000R17IE4](#) [DF1000R17IE4D_B2](#) [DF1400R12IP4D](#) [DF200R12PT4_B6](#) [DF400R07PE4R_B6](#)
[BSM75GB120DN2_E3223c-Se](#) [F3L300R12ME4_B22](#) [F3L75R07W2E3_B11](#) [F4-50R12KS4_B11](#) [F475R07W1H3B11ABOMA1](#)
[FD1400R12IP4D](#) [FD200R12PT4_B6](#) [FD800R33KF2C-K](#) [FF1200R17KP4_B2](#) [FF300R17KE3_S4](#) [FF300R17ME4_B11](#) [FF401R17KF6C_B2](#)
[FF650R17IE4D_B2](#) [FF900R12IP4D](#) [FF900R12IP4DV](#) [STGIF7CH60TS-L](#) [FP50R07N2E4_B11](#) [FS100R07PE4](#) [FS150R07N3E4_B11](#)
[FS150R17N3E4](#) [FS150R17PE4](#) [FS225R12KE4](#)