

## 62 mm C-Series module with TRENCHSTOP™ IGBT7 and emitter controlled 7 diode

### Features

- Electrical features
  - $V_{CES} = 1200\text{ V}$
  - $I_{C\text{nom}} = 800\text{ A} / I_{CRM} = 1600\text{ A}$
  - TRENCHSTOP™ IGBT7
  - $V_{CE,\text{sat}}$  with positive temperature coefficient
- Mechanical features
  - Standard housing
  - 4 kV AC 1 min insulation
  - High creepage and clearance distances
  - High power density
  - Isolated base plate
  - Package with CTI > 400



Typical appearance

### Potential applications

- Three-level applications
- Commercial agriculture vehicles
- High-power converters
- Motor drives
- Servo drives
- Solar applications
- UPS systems

### Product validation

- Qualified for industrial applications according to the relevant tests of IEC 60747, 60749 and 60068

### Description

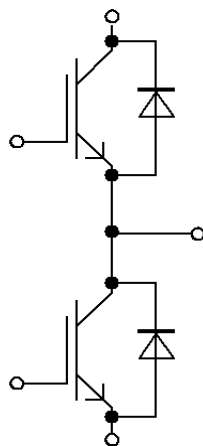

## Table of contents

	<b>Description</b> .....	1
	<b>Features</b> .....	1
	<b>Potential applications</b> .....	1
	<b>Product validation</b> .....	1
	<b>Table of contents</b> .....	2
<b>1</b>	<b>Package</b> .....	3
<b>2</b>	<b>IGBT, Inverter</b> .....	3
<b>3</b>	<b>Diode, Inverter</b> .....	5
<b>4</b>	<b>Characteristics diagrams</b> .....	7
<b>5</b>	<b>Circuit diagram</b> .....	11
<b>6</b>	<b>Package outlines</b> .....	12
<b>7</b>	<b>Module label code</b> .....	13
	<b>Revision history</b> .....	14
	<b>Disclaimer</b> .....	15

## 1 Package

**Table 1** Insulation coordination

Parameter	Symbol	Note or test condition	Values	Unit
Isolation test voltage	$V_{ISOL}$	RMS, $f = 50 \text{ Hz}$ , $t = 60 \text{ s}$	4.0	kV
Material of module baseplate			Cu	
Internal isolation		basic insulation (class 1, IEC 61140)	$Al_2O_3$	
Creepage distance	$d_{Creep}$	terminal to heatsink	29.0	mm
Creepage distance	$d_{Creep}$	terminal to terminal	23.0	mm
Clearance	$d_{Clear}$	terminal to heatsink	23.0	mm
Clearance	$d_{Clear}$	terminal to terminal	11.0	mm
Comparative tracking index	$CTI$		> 400	
Relative thermal index (electrical)	$RTI$	housing	140	°C

**Table 2** Characteristic values

Parameter	Symbol	Note or test condition	Values			Unit
			Min.	Typ.	Max.	
Stray inductance module	$L_{sCE}$			20		nH
Module lead resistance, terminals - chip	$R_{CC'+EE'}$	$T_C = 25^\circ\text{C}$ , per switch		0.5		mΩ
Storage temperature	$T_{stg}$		-40		125	°C
Mounting torque for module mounting	$M$	- Mounting according to valid application note	M5, Screw	3	6	Nm
Terminal connection torque	$M$	- Mounting according to valid application note	M6, Screw	2.5	5	Nm
Weight	$G$			340		g

## 2 IGBT, Inverter

**Table 3** Maximum rated values

Parameter	Symbol	Note or test condition	Values	Unit
Collector-emitter voltage	$V_{CES}$	$T_{vj} = 25^\circ\text{C}$	1200	V
Continuous DC collector current	$I_{CDC}$	$T_{vj \text{ max}} = 175^\circ\text{C}$ $T_C = 90^\circ\text{C}$	800	A
Maximum RMS module DC-terminal current	$I_{tRMS}$	$T_{Terminal} = 115^\circ\text{C}$ , $T_C = 90^\circ\text{C}$	650	A
		$T_{Terminal} = 115^\circ\text{C}$ , $T_C = 115^\circ\text{C}$	600	

(table continues...)  
 Datasheet

**Table 3 (continued) Maximum rated values**

Parameter	Symbol	Note or test condition	Values	Unit
Repetitive peak collector current	$I_{CRM}$	$t_p$ limited by $T_{vj\ op}$	1600	A
Gate-emitter peak voltage	$V_{GES}$		$\pm 20$	V

**Table 4 Characteristic values**

Parameter	Symbol	Note or test condition	Values			Unit
			Min.	Typ.	Max.	
Collector-emitter saturation voltage	$V_{CE\ sat}$	$I_C = 800\ A, V_{GE} = 15\ V$	$T_{vj} = 25\ ^\circ C$	1.50	1.75	V
			$T_{vj} = 125\ ^\circ C$	1.65		
			$T_{vj} = 150\ ^\circ C$	1.70		
			$T_{vj} = 175\ ^\circ C$	1.75		
Gate threshold voltage	$V_{Geth}$	$I_C = 16\ mA, V_{CE} = V_{GE}, T_{vj} = 25\ ^\circ C$	5.15	5.80	6.45	V
Gate charge	$Q_G$	$V_{GE} = \pm 15\ V, V_{CC} = 600\ V$		12.8		$\mu C$
Internal gate resistor	$R_{Gint}$	$T_{vj} = 25\ ^\circ C$		0.43		$\Omega$
Input capacitance	$C_{ies}$	$f = 100\ kHz, T_{vj} = 25\ ^\circ C, V_{CE} = 25\ V, V_{GE} = 0\ V$		122		nF
Reverse transfer capacitance	$C_{res}$	$f = 100\ kHz, T_{vj} = 25\ ^\circ C, V_{CE} = 25\ V, V_{GE} = 0\ V$		0.6		nF
Collector-emitter cut-off current	$I_{CES}$	$V_{CE} = 1200\ V, V_{GE} = 0\ V$			0.1	mA
Gate-emitter leakage current	$I_{GES}$	$V_{CE} = 0\ V, V_{GE} = 20\ V, T_{vj} = 25\ ^\circ C$			100	nA
Turn-on delay time (inductive load)	$t_{don}$	$I_C = 800\ A, V_{CC} = 600\ V, V_{GE} = \pm 15\ V, R_{Gon} = 0.51\ \Omega$	$T_{vj} = 25\ ^\circ C$	0.500		$\mu s$
			$T_{vj} = 125\ ^\circ C$	0.517		
			$T_{vj} = 150\ ^\circ C$	0.522		
			$T_{vj} = 175\ ^\circ C$	0.527		
Rise time (inductive load)	$t_r$	$I_C = 800\ A, V_{CC} = 600\ V, V_{GE} = \pm 15\ V, R_{Gon} = 0.51\ \Omega$	$T_{vj} = 25\ ^\circ C$	0.065		$\mu s$
			$T_{vj} = 125\ ^\circ C$	0.073		
			$T_{vj} = 150\ ^\circ C$	0.075		
			$T_{vj} = 175\ ^\circ C$	0.077		
Turn-off delay time (inductive load)	$t_{doff}$	$I_C = 800\ A, V_{CC} = 600\ V, V_{GE} = \pm 15\ V, R_{Goff} = 0.51\ \Omega$	$T_{vj} = 25\ ^\circ C$	0.544		$\mu s$
			$T_{vj} = 125\ ^\circ C$	0.628		
			$T_{vj} = 150\ ^\circ C$	0.652		
			$T_{vj} = 175\ ^\circ C$	0.675		

(table continues...)

**Table 4 (continued) Characteristic values**

Parameter	Symbol	Note or test condition	Values			Unit
			Min.	Typ.	Max.	
Fall time (inductive load)	$t_f$	$I_C = 800 \text{ A}, V_{CC} = 600 \text{ V}, V_{GE} = \pm 15 \text{ V}, R_{Goff} = 0.51 \Omega$	$T_{vj} = 25 \text{ }^\circ\text{C}$		0.122	$\mu\text{s}$
			$T_{vj} = 125 \text{ }^\circ\text{C}$		0.260	
			$T_{vj} = 150 \text{ }^\circ\text{C}$		0.310	
			$T_{vj} = 175 \text{ }^\circ\text{C}$		0.360	
Turn-on energy loss per pulse	$E_{on}$	$I_C = 800 \text{ A}, V_{CC} = 600 \text{ V}, L_\sigma = 25 \text{ nH}, V_{GE} = \pm 15 \text{ V}, R_{Gon} = 0.51 \Omega, di/dt = 8700 \text{ A}/\mu\text{s} (T_{vj} = 175 \text{ }^\circ\text{C})$	$T_{vj} = 25 \text{ }^\circ\text{C}$		27.2	mJ
			$T_{vj} = 125 \text{ }^\circ\text{C}$		42.7	
			$T_{vj} = 150 \text{ }^\circ\text{C}$		48.7	
			$T_{vj} = 175 \text{ }^\circ\text{C}$		54.6	
Turn-off energy loss per pulse	$E_{off}$	$I_C = 800 \text{ A}, V_{CC} = 600 \text{ V}, L_\sigma = 25 \text{ nH}, V_{GE} = \pm 15 \text{ V}, R_{Goff} = 0.51 \Omega, dv/dt = 3400 \text{ V}/\mu\text{s} (T_{vj} = 175 \text{ }^\circ\text{C})$	$T_{vj} = 25 \text{ }^\circ\text{C}$		69.7	mJ
			$T_{vj} = 125 \text{ }^\circ\text{C}$		108	
			$T_{vj} = 150 \text{ }^\circ\text{C}$		120	
			$T_{vj} = 175 \text{ }^\circ\text{C}$		132	
SC data	$I_{SC}$	$V_{GE} \leq 15 \text{ V}, V_{CC} = 800 \text{ V}, V_{CEmax} = V_{CES} - L_{sCE} * di/dt$	$t_p \leq 8 \mu\text{s}, T_{vj} = 150 \text{ }^\circ\text{C}$		3000	A
			$t_p \leq 6 \mu\text{s}, T_{vj} = 175 \text{ }^\circ\text{C}$		2700	
Thermal resistance, junction to case	$R_{thJC}$	per IGBT			0.0483	K/W
Thermal resistance, case to heat sink	$R_{thCH}$	per IGBT			0.0251	K/W
Temperature under switching conditions	$T_{vj op}$			-40	175	$^\circ\text{C}$

Note:  $T_{vj op} > 150 \text{ }^\circ\text{C}$  is allowed for operation at overload conditions. For detailed specifications, please refer to AN 2018-14.

### 3 Diode, Inverter

**Table 5 Maximum rated values**

Parameter	Symbol	Note or test condition	Values	Unit
Repetitive peak reverse voltage	$V_{RRM}$	$T_{vj} = 25 \text{ }^\circ\text{C}$	1200	V
Continuous DC forward current	$I_F$		800	A
Repetitive peak forward current	$I_{FRM}$	$t_p = 1 \text{ ms}$	1600	A

(table continues...)

**Table 5 (continued) Maximum rated values**

Parameter	Symbol	Note or test condition	Values	Unit	
I <sup>2</sup> t - value	I <sup>2</sup> t	t <sub>p</sub> = 10 ms, V <sub>R</sub> = 0 V	T <sub>vj</sub> = 125 °C	53000	A <sup>2</sup> s
			T <sub>vj</sub> = 175 °C	41000	

**Table 6 Characteristic values**

Parameter	Symbol	Note or test condition	Values			Unit	
			Min.	Typ.	Max.		
Forward voltage	V <sub>F</sub>	I <sub>F</sub> = 800 A, V <sub>GE</sub> = 0 V	T <sub>vj</sub> = 25 °C		1.80	2.10	V
			T <sub>vj</sub> = 125 °C		1.70		
			T <sub>vj</sub> = 150 °C		1.65		
			T <sub>vj</sub> = 175 °C		1.60		
Peak reverse recovery current	I <sub>RM</sub>	V <sub>CC</sub> = 600 V, I <sub>F</sub> = 800 A, V <sub>GE</sub> = -15 V, -di <sub>F</sub> /dt = 8700 A/μs (T <sub>vj</sub> = 175 °C)	T <sub>vj</sub> = 25 °C		540		A
			T <sub>vj</sub> = 125 °C		720		
			T <sub>vj</sub> = 150 °C		765		
			T <sub>vj</sub> = 175 °C		810		
Recovered charge	Q <sub>r</sub>	V <sub>CC</sub> = 600 V, I <sub>F</sub> = 800 A, V <sub>GE</sub> = -15 V, -di <sub>F</sub> /dt = 8700 A/μs (T <sub>vj</sub> = 175 °C)	T <sub>vj</sub> = 25 °C		62		μC
			T <sub>vj</sub> = 125 °C		117		
			T <sub>vj</sub> = 150 °C		137		
			T <sub>vj</sub> = 175 °C		156		
Reverse recovery energy	E <sub>rec</sub>	V <sub>CC</sub> = 600 V, I <sub>F</sub> = 800 A, V <sub>GE</sub> = -15 V, -di <sub>F</sub> /dt = 8700 A/μs (T <sub>vj</sub> = 175 °C)	T <sub>vj</sub> = 25 °C		27.9		mJ
			T <sub>vj</sub> = 125 °C		54.5		
			T <sub>vj</sub> = 150 °C		63.3		
			T <sub>vj</sub> = 175 °C		72.1		
Thermal resistance, junction to case	R <sub>thJC</sub>	per diode			0.0892	K/W	
Thermal resistance, case to heat sink	R <sub>thCH</sub>	per diode		0.0333		K/W	
Temperature under switching conditions	T <sub>vj op</sub>		-40		175	°C	

Note: T<sub>vj op</sub> > 150 °C is allowed for operation at overload conditions. For detailed specifications, please refer to AN 2018-14.

## 4 Characteristics diagrams

**Output characteristic (typical), IGBT, Inverter**

$$I_C = f(V_{CE})$$

$$V_{GE} = 15 \text{ V}$$

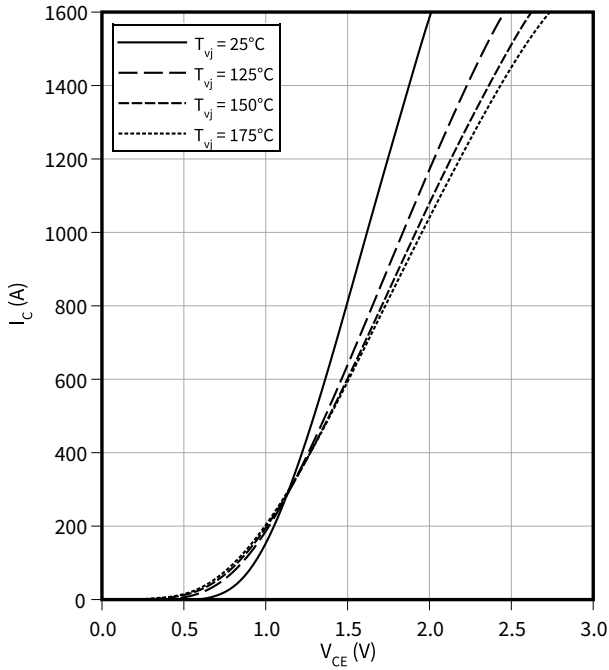

**Output characteristic field (typical), IGBT, Inverter**

$$I_C = f(V_{CE})$$

$$T_{vj} = 175 \text{ °C}$$

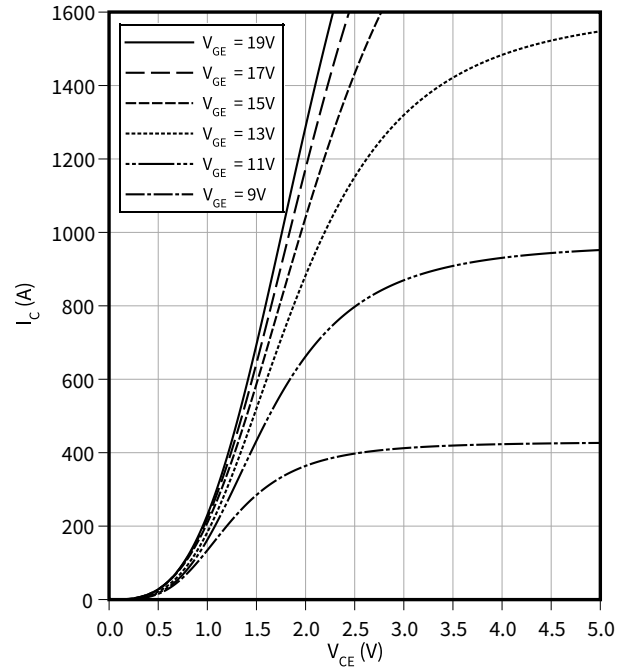

**Transfer characteristic (typical), IGBT, Inverter**

$$I_C = f(V_{GE})$$

$$V_{CE} = 20 \text{ V}$$

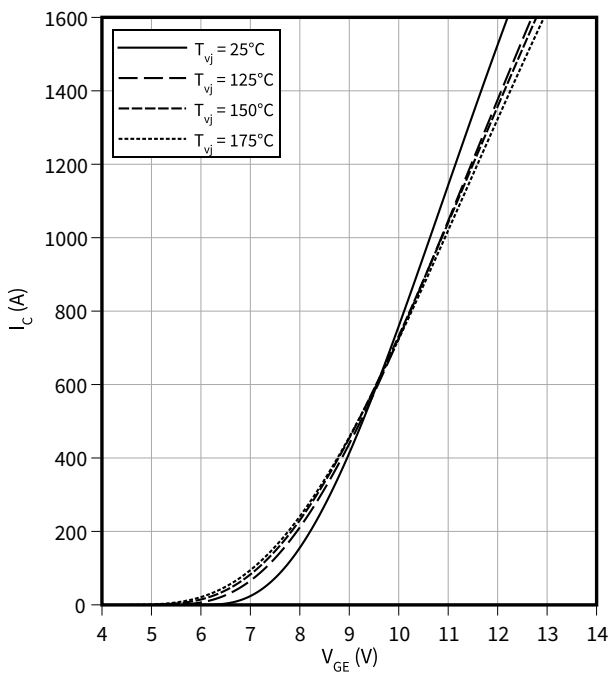

**Switching losses (typical), IGBT, Inverter**

$$E = f(I_C)$$

$$R_{Goff} = 0.51 \text{ } \Omega, R_{Gon} = 0.51 \text{ } \Omega, V_{CC} = 600 \text{ V}, V_{GE} = \pm 15 \text{ V}$$

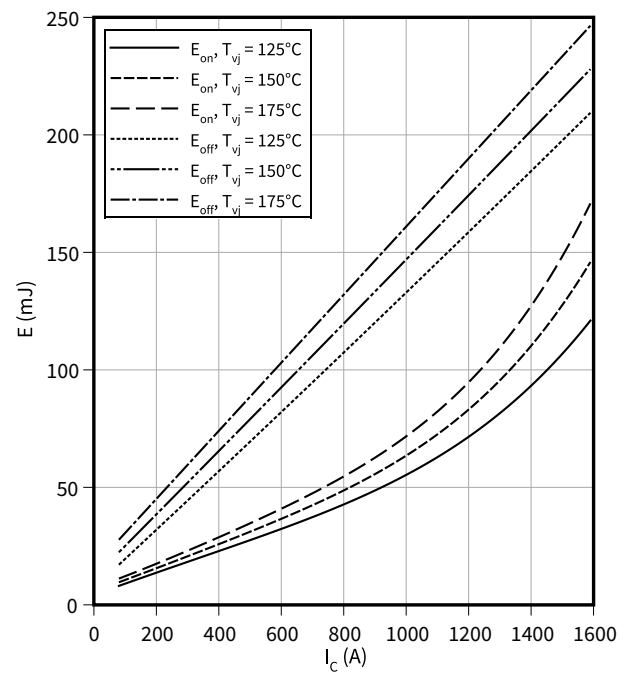

4 Characteristics diagrams

**Switching losses (typical), IGBT, Inverter**

$E = f(R_G)$

$I_C = 800 \text{ A}$ ,  $V_{CC} = 600 \text{ V}$ ,  $V_{GE} = \pm 15 \text{ V}$

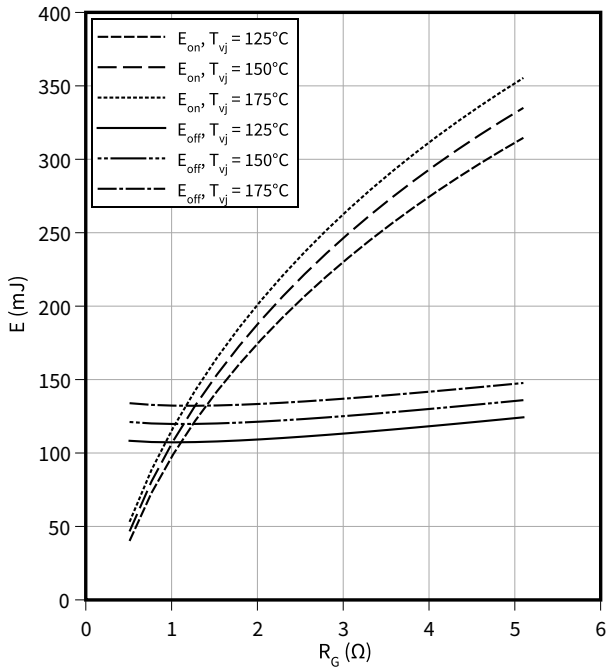

**Switching times (typical), IGBT, Inverter**

$t = f(I_C)$

$R_{Goff} = 0.51 \Omega$ ,  $R_{Gon} = 0.51 \Omega$ ,  $V_{CC} = 600 \text{ V}$ ,  $V_{GE} = \pm 15 \text{ V}$ ,  $T_{vj} = 175 \text{ °C}$

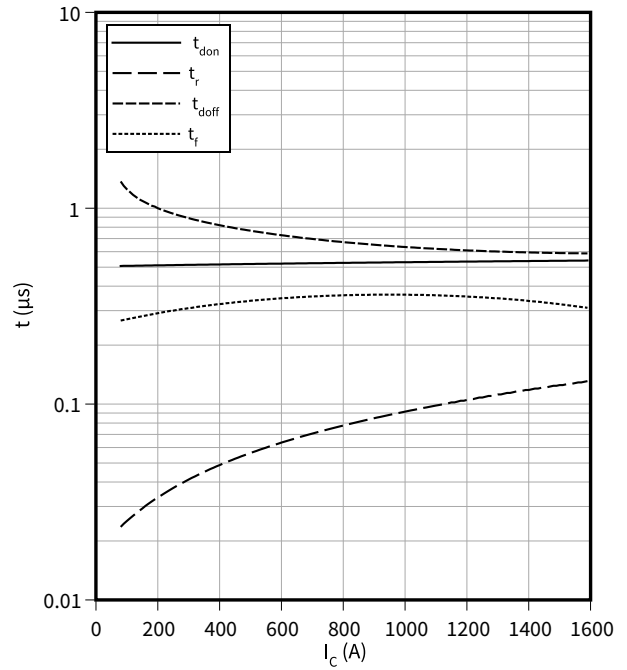

**Switching times (typical), IGBT, Inverter**

$t = f(R_G)$

$I_C = 800 \text{ A}$ ,  $V_{CC} = 600 \text{ V}$ ,  $V_{GE} = \pm 15 \text{ V}$ ,  $T_{vj} = 175 \text{ °C}$

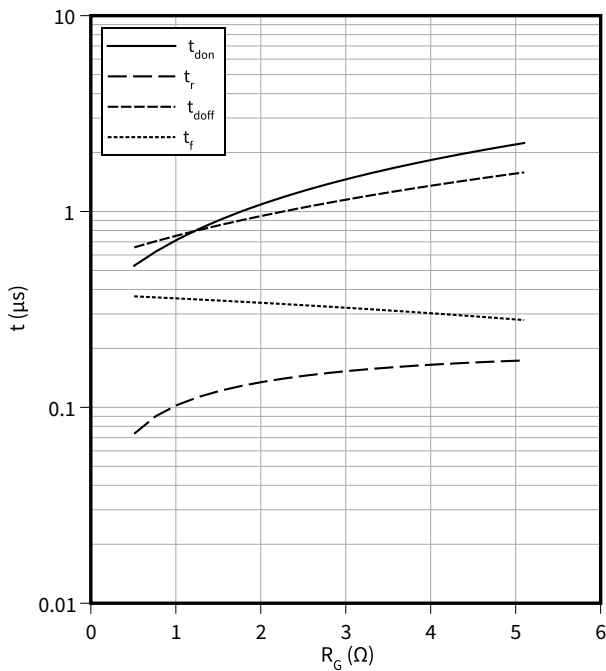

**Voltage slope (typical), IGBT, Inverter**

$dv/dt = f(R_G)$

$I_C = 800 \text{ A}$ ,  $V_{CC} = 600 \text{ V}$ ,  $V_{GE} = \pm 15 \text{ V}$ ,  $T_{vj} = 25 \text{ °C}$

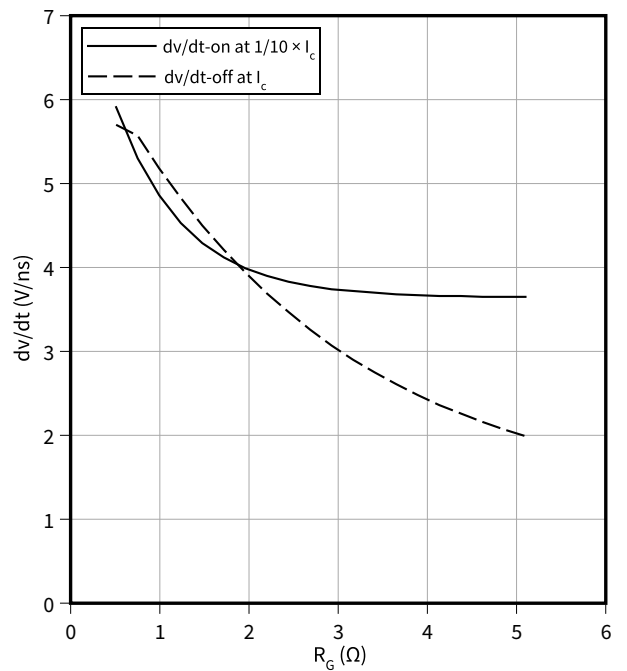



4 Characteristics diagrams

**Transient thermal impedance, IGBT, Inverter**

$Z_{th} = f(t)$

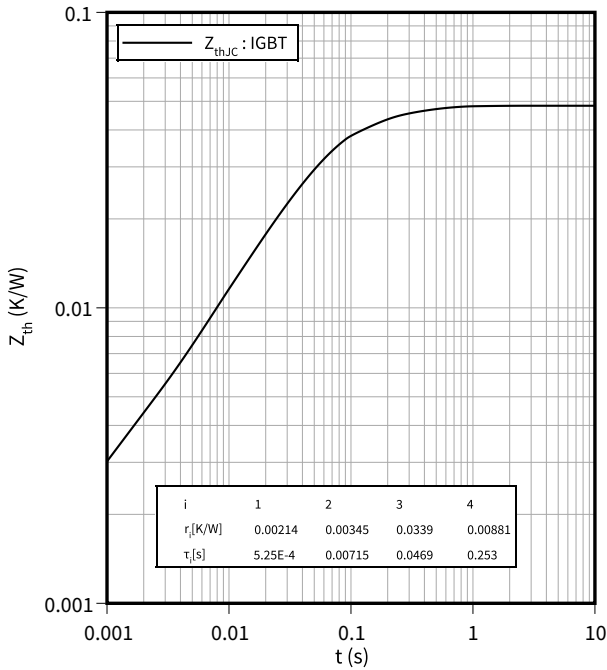

**Reverse bias safe operating area (RBSOA), IGBT, Inverter**

$I_C = f(V_{CE})$

$R_{Goff} = 0.51 \Omega, V_{GE} = \pm 15 V, T_{vj} = 175 \text{ }^\circ\text{C}$

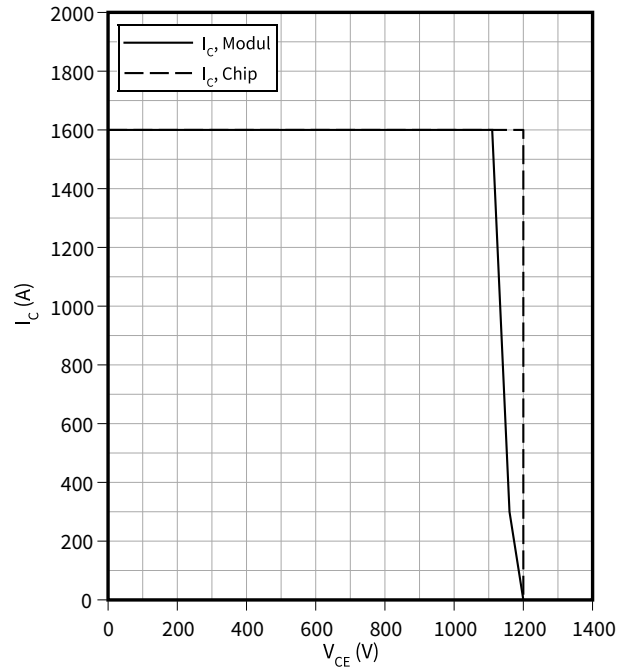

**Capacity characteristic (typical), IGBT, Inverter**

$C = f(V_{CE})$

$f = 100 \text{ kHz}, V_{GE} = 0 V, T_{vj} = 25 \text{ }^\circ\text{C}$

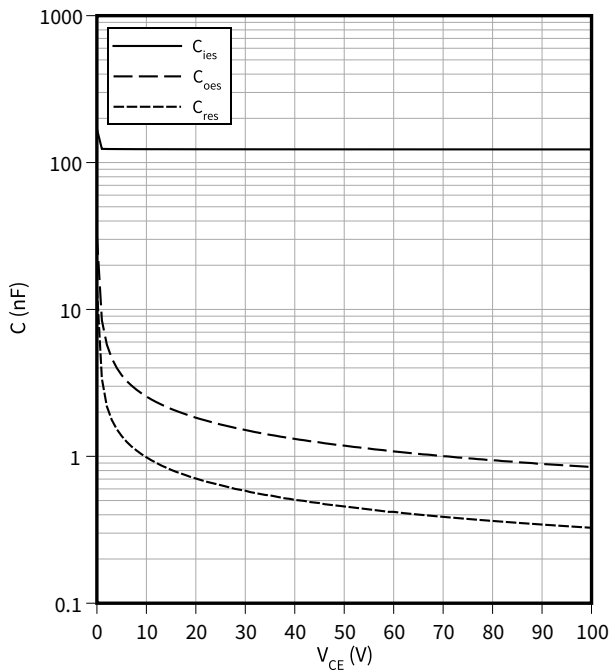

**Gate charge characteristic (typical), IGBT, Inverter**

$V_{GE} = f(Q_G)$

$I_C = 800 \text{ A}, T_{vj} = 25 \text{ }^\circ\text{C}$

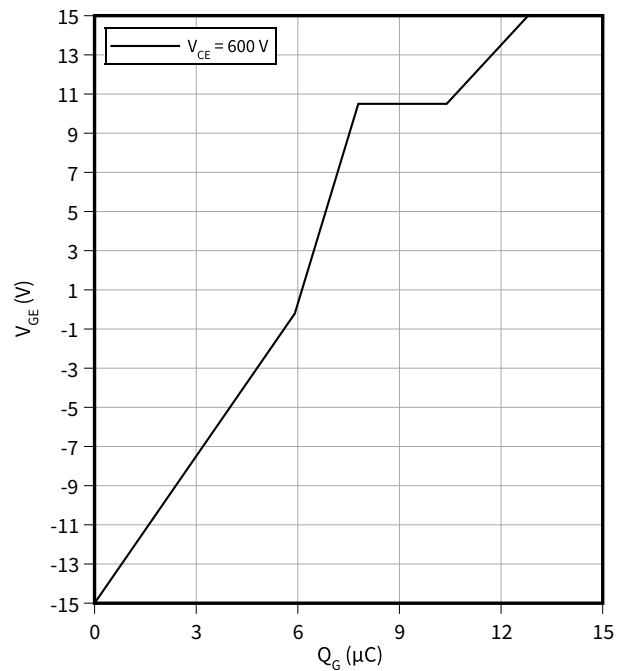

4 Characteristics diagrams

**Forward characteristic (typical), Diode, Inverter**

$I_F = f(V_F)$

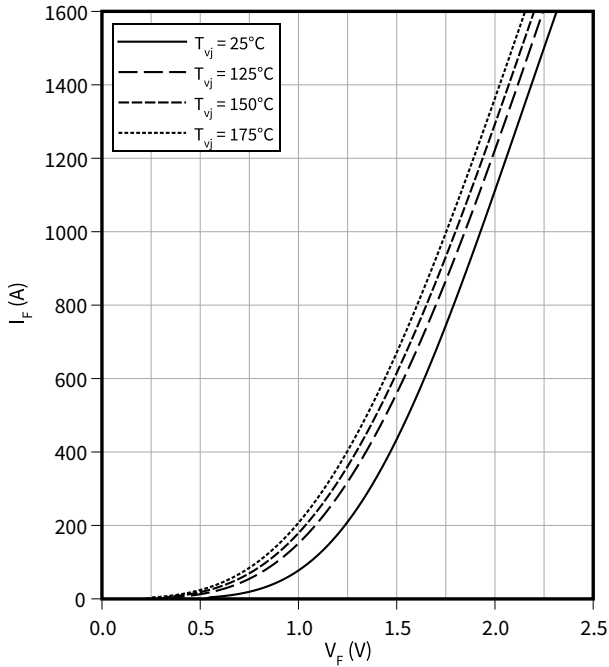

**Switching losses (typical), Diode, Inverter**

$E_{rec} = f(I_F)$

$R_{Gon} = 0.51 \Omega, V_{CE} = 600 V$

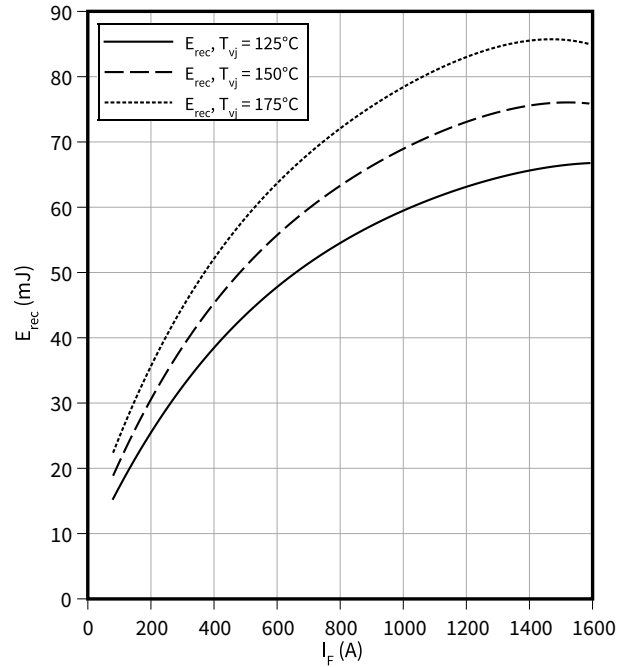

**Switching losses (typical), Diode, Inverter**

$E_{rec} = f(R_G)$

$V_{CE} = 600 V, I_F = 800 A$

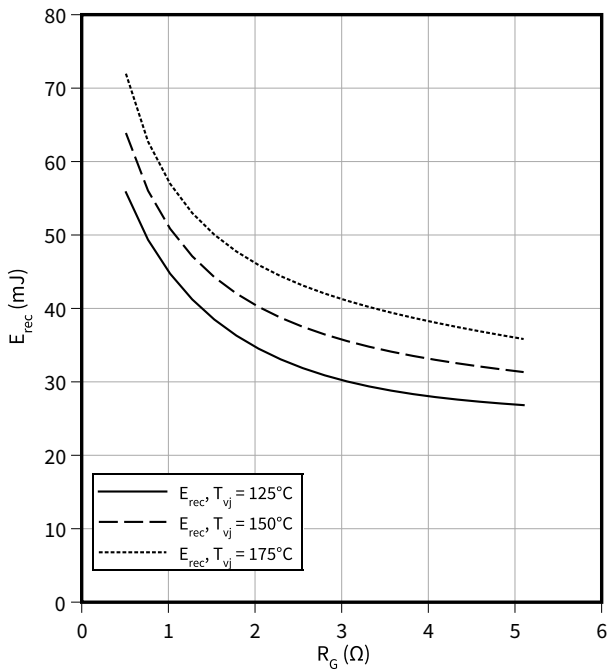

**Transient thermal impedance, Diode, Inverter**

$Z_{th} = f(t)$

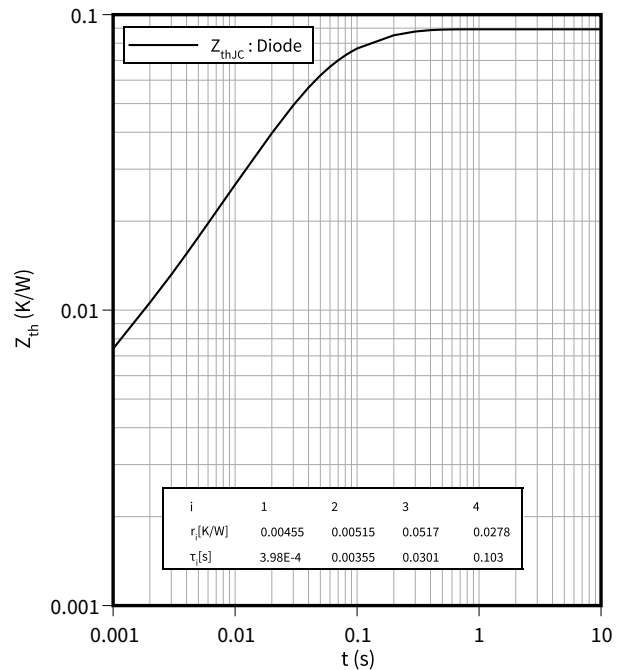

## 5 Circuit diagram

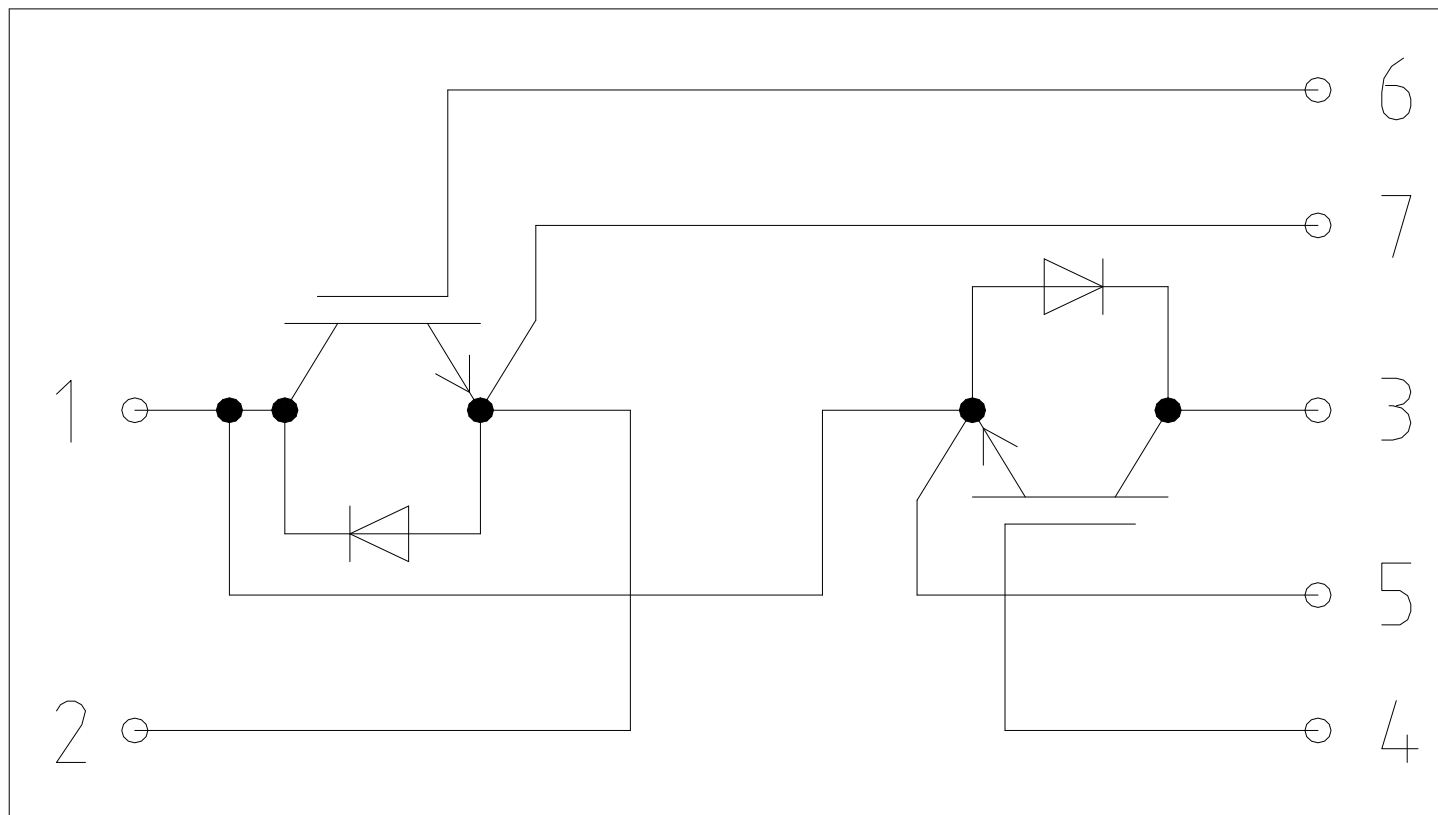
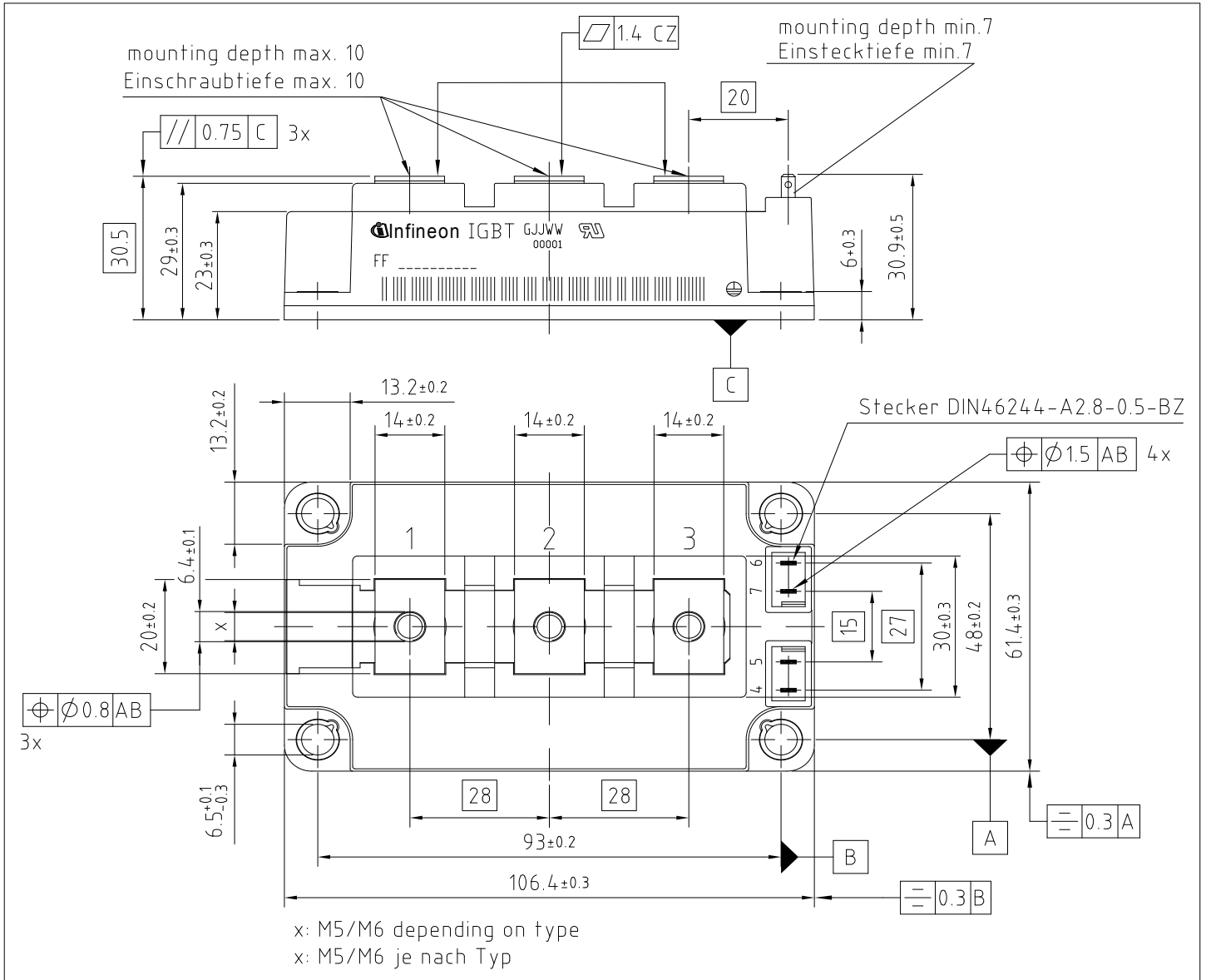



Figure 1

**6 Package outlines**



**Figure 2**

## 7 Module label code

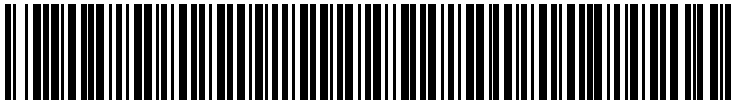
Module label code			
Code format	Data Matrix	Barcode Code128	
Encoding	ASCII text	Code Set A	
Symbol size	16x16	23 digits	
Standard	IEC24720 and IEC16022	IEC8859-1	
Code content	<i>Content</i>	<i>Digit</i>	<i>Example</i>
	Module serial number	1 - 5	71549
	Module material number	6 - 11	142846
	Production order number	12 - 19	55054991
	Date code (production year)	20 - 21	15
	Date code (production week)	22 - 23	30
Example	 		
	71549142846550549911530		71549142846550549911530

**Figure 3**

## Revision history

Document revision	Date of release	Description of changes
V1.0	2020-06-19	Target datasheet
V1.1	2020-08-21	Target datasheet
n/a	2020-09-01	Datasheet migrated to a new system with a new layout and new revision number schema: target or preliminary datasheet = 0.xy; final datasheet = 1.xy
0.10	2021-09-02	Target datasheet
0.30	2021-11-15	Target datasheet
0.40	2021-12-17	Preliminary datasheet
1.00	2022-05-11	Final datasheet

## Trademarks

All referenced product or service names and trademarks are the property of their respective owners.

**Edition 2022-05-11**

**Published by**

**Infineon Technologies AG**

**81726 Munich, Germany**

**© 2022 Infineon Technologies AG**

**All Rights Reserved.**

**Do you have a question about any aspect of this document?**

**Email: [erratum@infineon.com](mailto:erratum@infineon.com)**

**Document reference**

**IFX-AAJ653-006**

## Important notice

The information given in this document shall in no event be regarded as a guarantee of conditions or characteristics ("Beschaffenhheitsgarantie").

With respect to any examples, hints or any typical values stated herein and/or any information regarding the application of the product, Infineon Technologies hereby disclaims any and all warranties and liabilities of any kind, including without limitation warranties of non-infringement of intellectual property rights of any third party.

In addition, any information given in this document is subject to customer's compliance with its obligations stated in this document and any applicable legal requirements, norms and standards concerning customer's products and any use of the product of Infineon Technologies in customer's applications.

The data contained in this document is exclusively intended for technically trained staff. It is the responsibility of customer's technical departments to evaluate the suitability of the product for the intended application and the completeness of the product information given in this document with respect to such application.

## Warnings

Due to technical requirements products may contain dangerous substances. For information on the types in question please contact your nearest Infineon Technologies office.

Except as otherwise explicitly approved by Infineon Technologies in a written document signed by authorized representatives of Infineon Technologies, Infineon Technologies' products may not be used in any applications where a failure of the product or any consequences of the use thereof can reasonably be expected to result in personal injury.

## X-ON Electronics

Largest Supplier of Electrical and Electronic Components

*Click to view similar products for [IGBT Modules category](#):*

*Click to view products by [Infineon manufacturer](#):*

Other Similar products are found below :

[F3L400R07ME4\\_B22](#) [F3L400R12PT4\\_B26](#) [FB20R06W1E3\\_B11](#) [FD300R12KE3](#) [FD300R12KS4\\_B5](#) [FD400R12KE3](#) [FF100R12KS4](#)  
[FF150R12KE3G](#) [FF200R06KE3](#) [FF200R06YE3](#) [FF300R06KE3\\_B2](#) [FF600R12IP4V](#) [FF800R17KP4\\_B2](#) [FF900R12IE4V](#)  
[FP06R12W1T4\\_B3](#) [FP100R07N3E4](#) [FP100R07N3E4\\_B11](#) [FP10R06W1E3\\_B11](#) [FP10R12W1T4\\_B11](#) [FP10R12YT3](#) [FP15R12W2T4](#)  
[FP15R12YT3](#) [FP20R06W1E3](#) [FP30R06W1E3](#) [FP40R12KT3G](#) [FP75R06KE3](#) [FS10R12YE3](#) [FS150R07PE4](#) [FS150R12PT4](#)  
[FS150R17N3E4\\_B11](#) [FS20R06W1E3\\_B11](#) [FS30R06W1E3\\_B11](#) [FS75R12KE3G](#) [FS75R12W2T4\\_B11](#) [FZ1600R17HP4\\_B2](#)  
[FZ300R12KE3G](#) [FZ400R17KE3](#) [FZ400R17KE4](#) [FZ600R65KE3](#) [DF1000R17IE4D\\_B2](#) [APTGT75DA60T1G](#) [DZ800S17K3](#) [F12-](#)  
[25R12KT4G](#) [F3L200R12W2H3\\_B11](#) [F3L300R12ME4\\_B22](#) [F3L75R07W2E3\\_B11](#) [F4-150R12KS4](#) [F475R07W1H3B11ABOMA1](#)  
[FD1400R12IP4D](#) [FD400R12KE3\\_B5](#)