

Final datasheet
HybridPACK™ Drive G2 module

Features

- Electrical features
 - $V_{CES} = 750\text{ V}$
 - $I_{CN} = 1150\text{ A} / I_{CRM} = 2300\text{ A}$
 - Blocking voltage 750 V
 - Low $V_{CE,sat}$
 - Low switching losses
 - Low Q_g and C_{rSS}
 - Low inductive design
 - $T_{vj,op} = 175^\circ\text{C}$
 - Integrated on-chip temperature sensor
 - Short-time extended operation temperature $T_{vj,op} = 185^\circ\text{C}$
- Mechanical features
 - 4.2 kV DC 1 second insulation
 - High creepage and clearance distances
 - Direct-cooled PinFin base plate
 - Guiding elements for PCB and cooler assembly
 - PressFIT contact technology
 - RoHS compliant, lead-free
 - UL 94 V0 module frame
 - High-performance Si_3N_4 ceramic
 - High power and thermal cycling capability

- Lead-free
- RoHS
- Green

Potential applications

- Automotive applications
- (Hybrid) electrical vehicles (H)EV

Product validation

- Qualified according to AQC 324, release no.: 03.1/2021

Description

The HybridPACK™ Drive is a very compact six-pack module (750V/1150A) optimized for hybrid and electric vehicles.

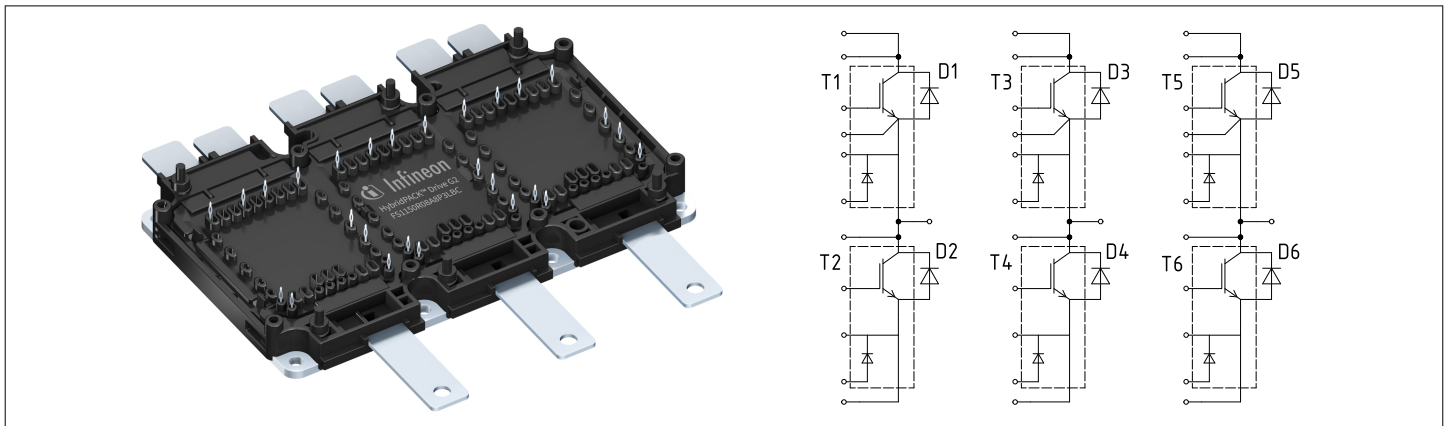

Table of contents

	Description	1
	Features	1
	Potential applications	1
	Product validation	1
	Table of contents	2
1	Package	3
2	IGBT, Inverter	4
3	Diode, Inverter	6
4	Temperature sensor	7
5	Characteristics diagrams	8
6	Circuit diagram	13
7	Package outlines	14
8	Module label code	17
	Revision history	18
	Disclaimer	19

1 Package

Table 1 Insulation coordination

Parameter	Symbol	Note or test condition	Values	Unit
Isolation test voltage	V_{ISOL}	RMS, $f = 0$ Hz, $t = 1$ sec	4.20	kV
Material of module baseplate			Cu+Ni ¹⁾	
Internal isolation		basic insulation (class 1, IEC 61140)	Si ₃ N ₄	
Creepage distance	d_{creep}	terminal to heatsink	9.5	mm
Creepage distance	d_{creep}	terminal to terminal	9.5	mm
Clearance	d_{clear}	terminal to heatsink	4.5	mm
Clearance	d_{clear}	terminal to terminal	4.5	mm
Comparative tracking index	CTI		> 175	

1) Ni plated Cu baseplate.

Table 2 Maximum rated values

Parameter	Symbol	Note or test condition	Values			Unit
			Min.	Typ.	Max.	
Maximum RMS module terminal current	$I_{t,rms}$		900			A
Heat-staking dome temperature ¹⁾	T_{HS}	$t_{steking} < 10s$			280	°C

1) Heat-staking according to application note AN-G2-ASSEMBLY.

Table 3 Characteristic values

Parameter	Symbol	Note or test condition	Values			Unit
			Min.	Typ.	Max.	
Pressure drop in cooling circuit	Δp	50% water / 50% ethylenglycol, $\Delta V/\Delta t = 10$ dm ³ /min, $T_f = 65$ °C		76 ¹⁾		mbar
Maximum pressure in cooling circuit	p	$T_{baseplate} < 40$ °C			3.0	bar
		$T_{baseplate} \geq 40$ °C (relative pressure)			2.5	
Stray inductance module	$L_{s,CE}$			8.0		nH
Module lead resistance, terminals - chip	$R_{CC'+EE'}$	$T_f = 25$ °C, per switch		0.73		mΩ
Storage temperature	T_{stg}		-40		125	°C
Mounting torque for module mounting ²⁾	M	Screw M4 baseplate to heatsink	1.8	2.0	2.2	Nm
		Screw EJOT Delta PCB to frame	0.45	0.50	0.55	
Weight	G			760		g

1) Cooler design and flow direction according to application note AN-G2-ASSEMBLY.

2) Screw types and torque according to application note AN-G2-ASSEMBLY.

2 IGBT, Inverter

Table 4 Maximum rated values

Parameter	Symbol	Note or test condition	Values			Unit
			Min.	Typ.	Max.	
Collector-emitter voltage	V_{CES}	$T_{vj} = 25\text{ °C}$		750		V
Implemented collector current	I_{CN}			1150		A
Continuous DC collector current	$I_{C,nom}$	$T_f = 65\text{ °C}, T_{vj,max} = 175\text{ °C}$		600 ¹⁾		A
Repetitive peak collector current	I_{CRM}	verified by design, t_p limited by $T_{vj,max}$		2300		A
Total power dissipation	P_{tot}	$T_f = 65\text{ °C}, T_{vj,max} = 175\text{ °C}$		1000 ¹⁾		W
Gate-emitter peak voltage	V_{GES}			±20		V

1) Verified by characterization / design not by test.

Table 5 Characteristic values

Parameter	Symbol	Note or test condition	Values			Unit	
			Min.	Typ.	Max.		
Collector-emitter saturation voltage	$V_{CE,sat}$	$I_C = 600\text{ A}, V_{GE} = 15\text{ V}$	$T_{vj} = 25\text{ °C}$		1.08	1.21	V
			$T_{vj} = 175\text{ °C}$		1.09		
Collector-emitter saturation voltage	$V_{CE,sat}$	$I_C = 1000\text{ A}, V_{GE} = 15\text{ V}$	$T_{vj} = 25\text{ °C}$		1.22		V
			$T_{vj} = 175\text{ °C}$		1.32		
Gate threshold voltage	$V_{GE,th}$	$I_C = 10.3\text{ mA}, V_{CE} = V_{GE}$	$T_{vj} = 25\text{ °C}$	4.9	5.8	6.65	V
			$T_{vj} = 175\text{ °C}$		4		
Gate charge	Q_G	$V_{CE} = 400\text{ V}, V_{GE} = -8...15\text{ V}$		2.6		μC	
Internal gate resistor	$R_{G,int}$		$T_{vj} = 25\text{ °C}$	1.0		Ω	
Input capacitance	C_{ies}	$f = 0.1\text{ MHz}, V_{CE} = 50\text{ V}, V_{GE} = 0\text{ V}$	$T_{vj} = 25\text{ °C}$	60.8		nF	
Output capacitance	C_{oes}	$f = 0.1\text{ MHz}, V_{CE} = 50\text{ V}, V_{GE} = 0\text{ V}$	$T_{vj} = 25\text{ °C}$	2.0		nF	
Reverse transfer capacitance	C_{res}	$f = 0.1\text{ MHz}, V_{CE} = 50\text{ V}, V_{GE} = 0\text{ V}$	$T_{vj} = 25\text{ °C}$	0.27		nF	
Collector-emitter cut-off current	I_{CES}	$V_{CE} = 750\text{ V}, V_{GE} = 0\text{ V}$	$T_{vj} = 25\text{ °C}$			1.0	mA
			$T_{vj} = 175\text{ °C}$			15.0	
			$T_{vj} = 185\text{ °C}$			28.0	
Gate-emitter leakage current	I_{GES}		$T_{vj} = 25\text{ °C}$			400	nA

(table continues...)

Table 5 (continued) Characteristic values

Parameter	Symbol	Note or test condition	Values			Unit
			Min.	Typ.	Max.	
Turn-on delay time, inductive load	$t_{d,on}$	$I_C = 600\text{ A}, V_{CE} = 400\text{ V}, V_{GE} = -8/15\text{ V}, R_{G,on} = 2.4\ \Omega$	$T_{vj} = 25\text{ }^\circ\text{C}$	222		ns
			$T_{vj} = 175\text{ }^\circ\text{C}$	255		
Rise time, inductive load	t_r	$I_C = 600\text{ A}, V_{CE} = 400\text{ V}, V_{GE} = -8/15\text{ V}, R_{G,on} = 2.4\ \Omega$	$T_{vj} = 25\text{ }^\circ\text{C}$	50.0		ns
			$T_{vj} = 175\text{ }^\circ\text{C}$	55.0		
Turn-off delay time, inductive load	$t_{d,off}$	$I_C = 600\text{ A}, V_{CE} = 400\text{ V}, V_{GE} = -8/15\text{ V}, R_{G,off} = 7.5\ \Omega$	$T_{vj} = 25\text{ }^\circ\text{C}$	929		ns
			$T_{vj} = 175\text{ }^\circ\text{C}$	1060		
Fall time, inductive load	t_f	$I_C = 600\text{ A}, V_{CE} = 400\text{ V}, V_{GE} = -8/15\text{ V}, R_{G,off} = 7.5\ \Omega$	$T_{vj} = 25\text{ }^\circ\text{C}$	91.0		ns
			$T_{vj} = 175\text{ }^\circ\text{C}$	199		
Turn-on energy loss per pulse	E_{on}	$I_C = 600\text{ A}, V_{CE} = 400\text{ V}, L_\sigma = 7\text{ nH}, V_{GE} = -8/15\text{ V}, R_{G,on} = 2.4\ \Omega$	$T_{vj} = 25\text{ }^\circ\text{C}, di/dt = 9600\text{ A}/\mu\text{s}$	4.5		mJ
			$T_{vj} = 175\text{ }^\circ\text{C}, di/dt = 8700\text{ A}/\mu\text{s}$	10.7		
Turn-off energy loss per pulse	E_{off}	$I_C = 600\text{ A}, V_{CE} = 400\text{ V}, L_\sigma = 7\text{ nH}, V_{GE} = -8/15\text{ V}, R_{G,off} = 7.5\ \Omega$	$T_{vj} = 25\text{ }^\circ\text{C}, du/dt = 4000\text{ V}/\mu\text{s}$	31.1		mJ
			$T_{vj} = 175\text{ }^\circ\text{C}, du/dt = 2700\text{ V}/\mu\text{s}$	43.0		
SC data	I_{SC}	$V_{CC} = 400\text{ V}, V_{GE} = 15\text{ V}, V_{CEmax} = V_{CES} - L_{sCE} \cdot di/dt$	$T_{vj} = 25\text{ }^\circ\text{C}, t_p = 3.0\ \mu\text{s}$	8500		A
			$T_{vj} = 175\text{ }^\circ\text{C}, t_p = 3.0\ \mu\text{s}$	6700		
			$T_{vj} = 185\text{ }^\circ\text{C}, t_p = 2.5\ \mu\text{s}$	6600		
Thermal resistance, junction to cooling fluid ¹⁾	$R_{th,j-f}$	50% water / 50% ethylenglycol, $\Delta V/\Delta t = 10\text{ dm}^3/\text{min}, T_f = 65\text{ }^\circ\text{C}$		0.100	0.110 ²⁾	K/W
Temperature under switching conditions ³⁾	$T_{vj,op}$	continuous operation	-40		175	°C
		extended operation			185	

1) Cooler design and flow direction according to application note AN-G2-ASSEMBLY.

2) EoL criteria see AQG324, verified by characterization with 4.5 sigma.

3) $T_{vj} > 175\text{ }^\circ\text{C}$ only blocking and short circuit capability specified

3 Diode, Inverter

Table 6 Maximum rated values

Parameter	Symbol	Note or test condition	Values	Unit
Repetitive peak reverse voltage	V_{RRM}	$T_{vj} = 25\text{ °C}$	750	V
Implemented forward current	I_{FN}		1150	A
Continuous DC forward current	$I_{F,nom}$		600	A
Repetitive peak forward current	I_{FRM}	verified by design, t_p limited by $T_{vj,max}$	2300	A
I^2t - value	I^2t	$V_R = 0\text{ V}$, $t_p = 10\text{ ms}$ $T_{vj} = 175\text{ °C}$	31250	A ² s

Table 7 Characteristic values

Parameter	Symbol	Note or test condition	Values			Unit
			Min.	Typ.	Max.	
Forward voltage	V_F	$I_F = 600\text{ A}$	$T_{vj} = 25\text{ °C}$	1.76	2.08	V
			$T_{vj} = 175\text{ °C}$	1.57		
Forward voltage	V_F	$I_F = 1000\text{ A}$	$T_{vj} = 25\text{ °C}$	2.09		V
			$T_{vj} = 175\text{ °C}$	1.95		
Peak reverse recovery current	I_{rm}	$I_F = 600\text{ A}$, $V_{GE} = -8\text{ V}$, $V_R = 400\text{ V}$	$T_{vj} = 25\text{ °C}$	351		A
			$T_{vj} = 175\text{ °C}$	526		
Recovered charge	Q_r	$I_F = 600\text{ A}$, $V_R = 400\text{ V}$, $V_{GE} = -8\text{ V}$	$T_{vj} = 25\text{ °C}$	14.4		μC
			$T_{vj} = 175\text{ °C}$	43.1		
Reverse recovery energy	E_{rec}	$I_F = 600\text{ A}$, $V_{GE} = -8\text{ V}$, $V_R = 400\text{ V}$	$T_{vj} = 25\text{ °C}$, $-di_F/dt = 16200\text{ A}/\mu\text{s}$	4.90		mJ
			$T_{vj} = 175\text{ °C}$, $-di_F/dt = 13400\text{ A}/\mu\text{s}$	13.40		
Thermal resistance, junction to cooling fluid ¹⁾	$R_{th,j-f}$	50% water / 50% ethylenglycol, $\Delta V/\Delta t = 10\text{ dm}^3/\text{min}$, $T_f = 65\text{ °C}$		0.129	0.142 ²⁾	K/W
Temperature under switching conditions ³⁾	$T_{vj,op}$	continuous operation	-40		175	°C
		extended operation			185	

1) Cooler design and flow direction according to application note AN-G2-ASSEMBLY.

2) EoL criteria see AQG324, verified by characterization with 4.5 sigma.

3) $T_{vj}>175\text{ °C}$ only blocking specified

4 Temperature sensor

Table 8 Characteristic values

Parameter	Symbol	Note or test condition	Values			Unit
			Min.	Typ.	Max.	
Transient sense current	I_{TS}				10	mA
Forward voltage	V_{TS}	$I_{TS} = 0.2 \text{ mA}$, $T_{vj} = 25 \text{ °C}$		2.280		V
Temperature coefficient (TCR)	TC_{TS}	$I_{TS} = 0.2 \text{ mA}$		-5.50		mV/K

5 Characteristics diagrams

Pressure drop in cooling circuit (typical), Package

$$\Delta p = f(\Delta V/\Delta t)$$

$T_f = 65\text{ }^\circ\text{C}$, fluid = 50% water / 50% ethylglycol

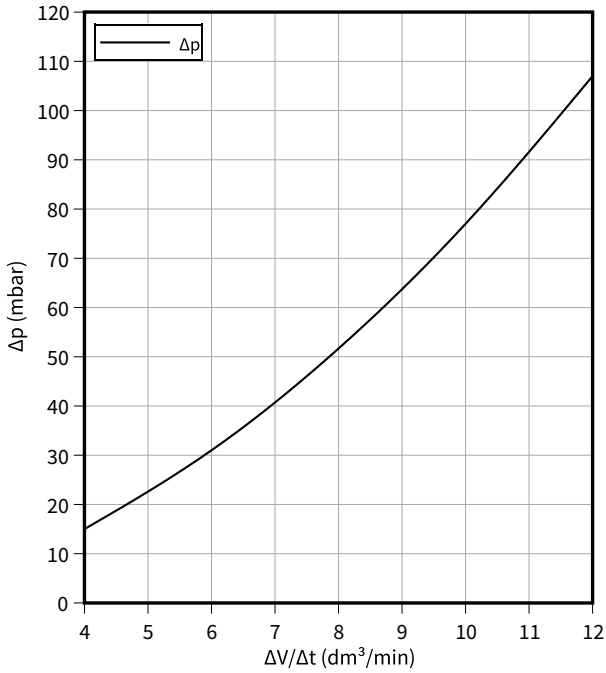

Maximum collector-emitter voltage, IGBT, Inverter

$$V_{CES} = f(T_{vj})$$

Note = verified by characterization / design not by test

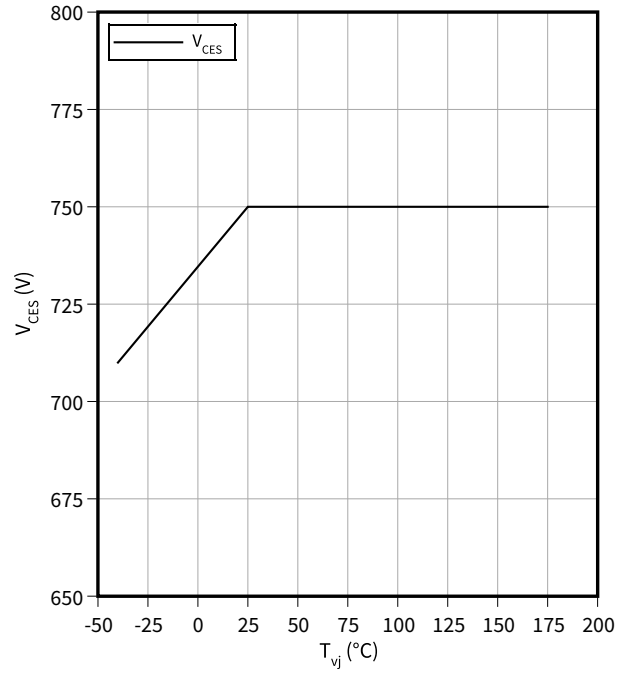

Output characteristic (typical), IGBT, Inverter

$$I_C = f(V_{CE})$$

$V_{GE} = 15\text{ V}$

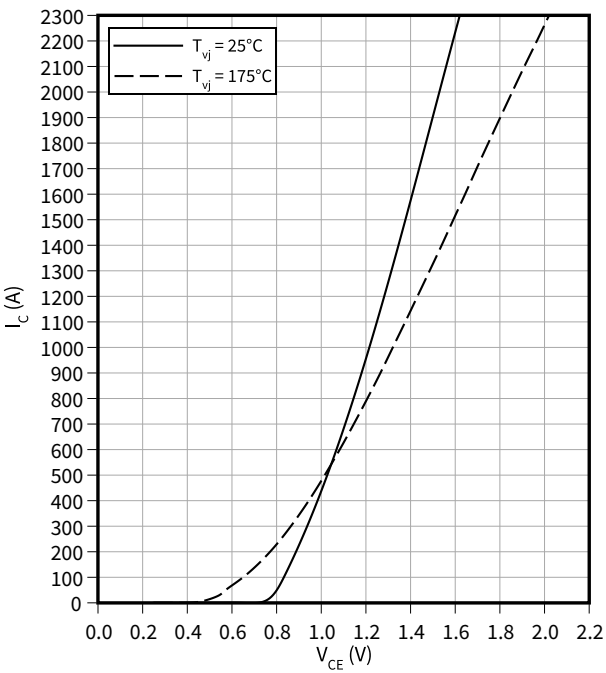

Output characteristic (typical), IGBT, Inverter

$$I_C = f(V_{CE})$$

$T_{vj} = 25\text{ }^\circ\text{C}$

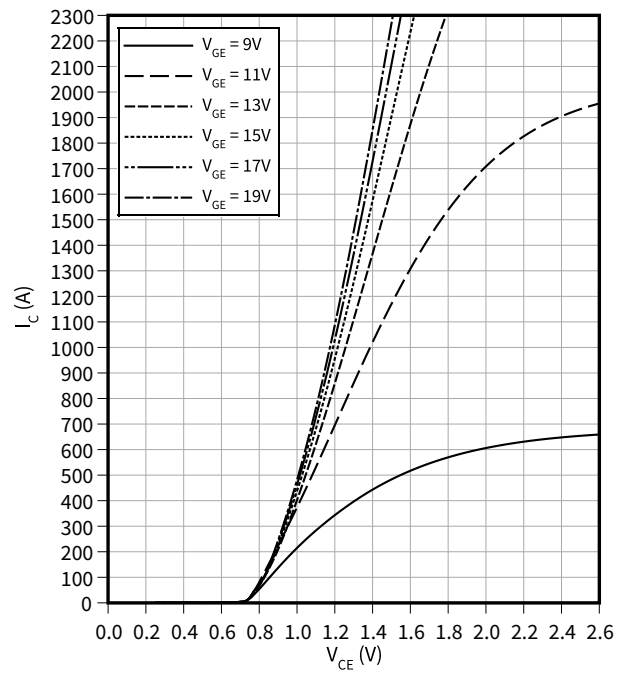

5 Characteristics diagrams

Transfer characteristic (typical), IGBT, Inverter

$I_C = f(V_{GE})$
 $V_{CE} = 20\text{ V}$

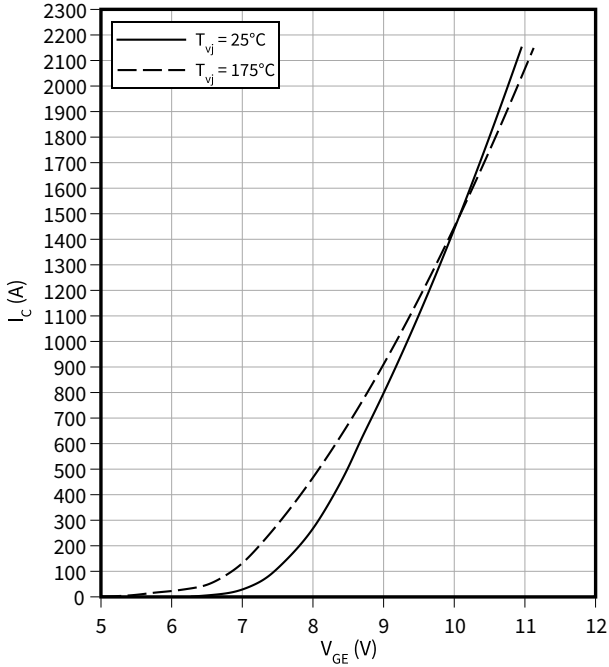

Gate charge characteristic (typical), IGBT, Inverter

$V_{GE} = f(Q_G)$
 $T_{vj} = 25^\circ\text{C}, V_{CE} = 400\text{ V}, I_C = 600\text{ A}$

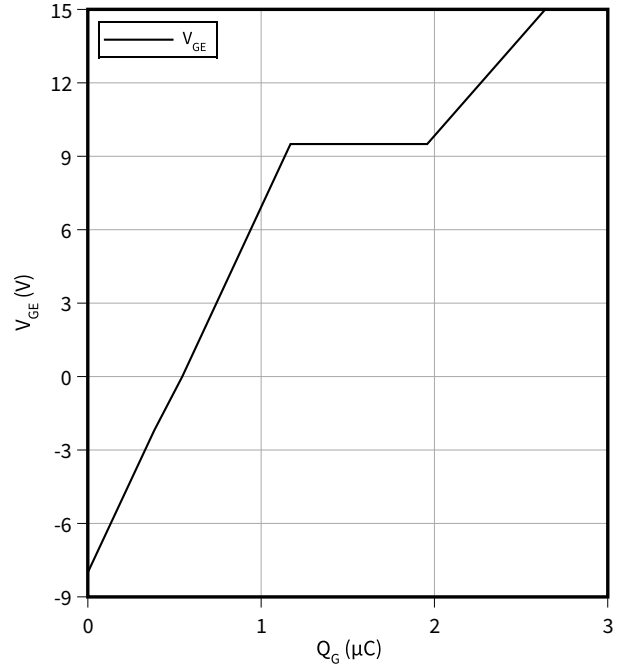

Capacity characteristic (typical), IGBT, Inverter

$C = f(V_{CE})$
 $T_{vj} = 25^\circ\text{C}, f = 0.1\text{ MHz}, V_{GE} = 0\text{ V}$

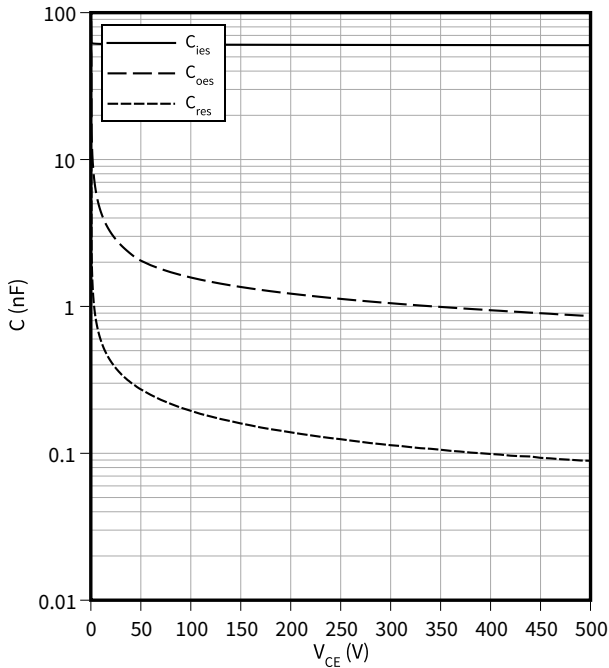

Switching losses (typical), IGBT, Inverter

$E = f(I_C)$
 $R_{G,off} = 7.5\ \Omega, R_{G,on} = 2.4\ \Omega, V_{CE} = 400\text{ V}, V_{GE} = +15/-8\text{ V}$

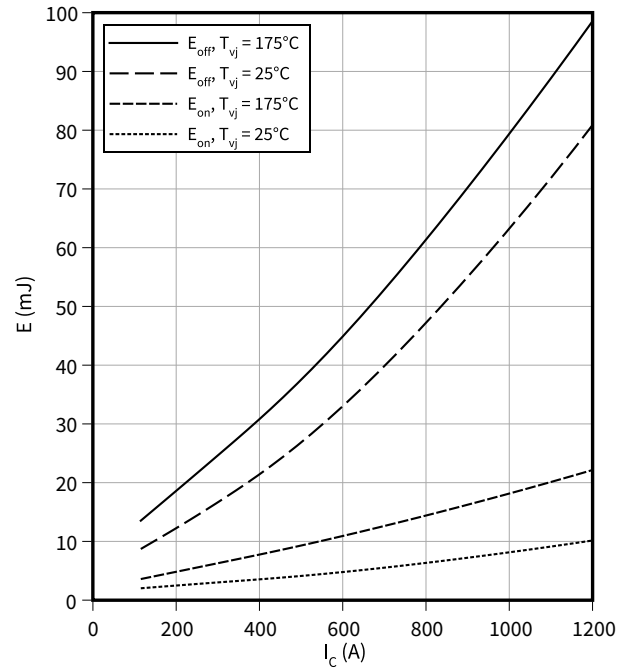

5 Characteristics diagrams

Switching losses (typical), IGBT, Inverter

$E = f(R_G)$

$I_C = 600 \text{ A}, V_{CE} = 400 \text{ V}, V_{GE} = +15/-8 \text{ V}$

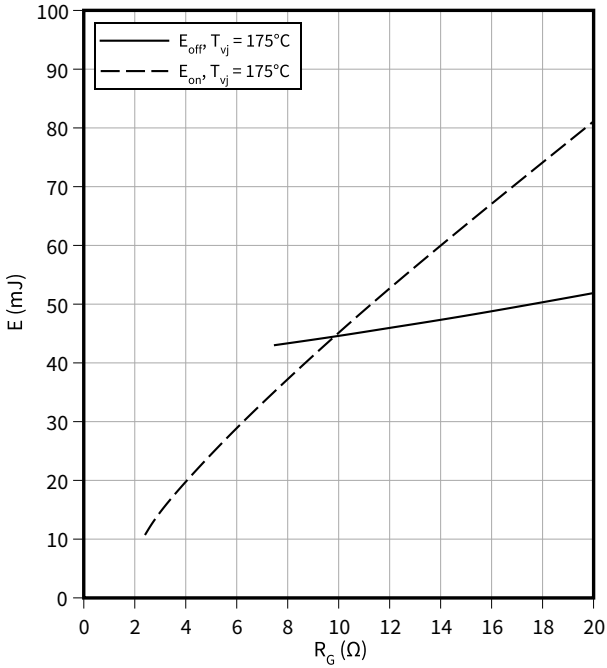

Reverse bias safe operating area (RBSOA), IGBT, Inverter

$I_C = f(V_{CE})$

$T_{vj} = 175^\circ\text{C}, R_{G,off} = 7.5 \Omega, V_{GE} = +15/-8 \text{ V}$

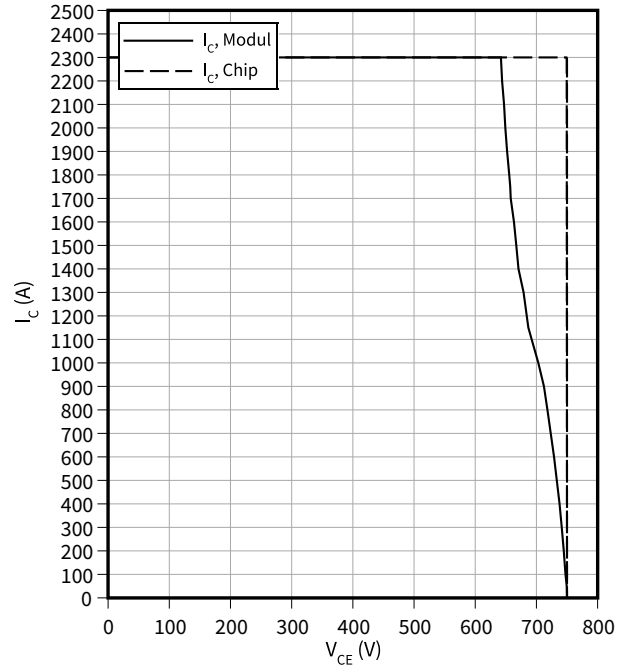

Transient thermal impedance (typical), IGBT, Inverter

$Z_{th} = f(t)$

$\Delta V/\Delta t = 10 \text{ dm}^3/\text{min}$, fluid = 50% water / 50% ethylenglycol, $T_f = 65^\circ\text{C}$

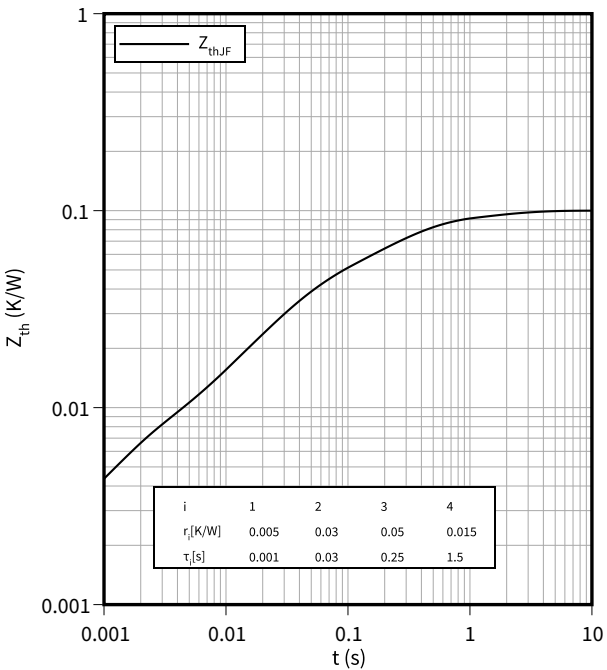

Thermal impedance (typical), IGBT, Inverter

$R_{thJF} = f(dv/dt)$

$T_f = 65^\circ\text{C}$, fluid = 50% water / 50% ethylenglycol

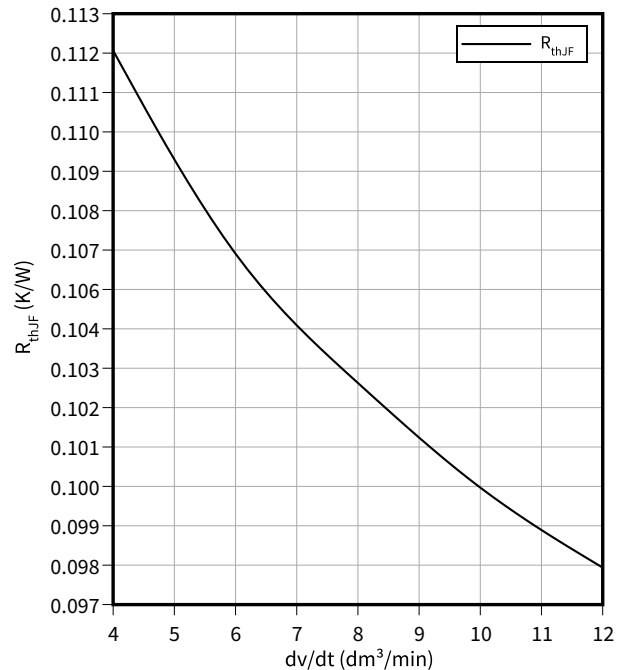

5 Characteristics diagrams

Forward characteristic (typical), Diode, Inverter

$I_F = f(V_F)$

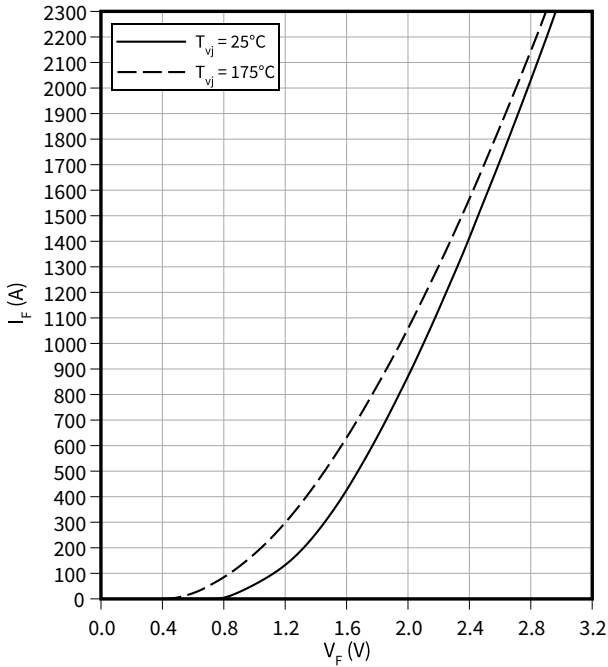

Switching losses (typical), Diode, Inverter

$E_{rec} = f(I_F)$

$V_{CE} = 400\text{ V}, V_{GE} = +15/-8\text{ V}, R_G = 2.4\ \Omega$

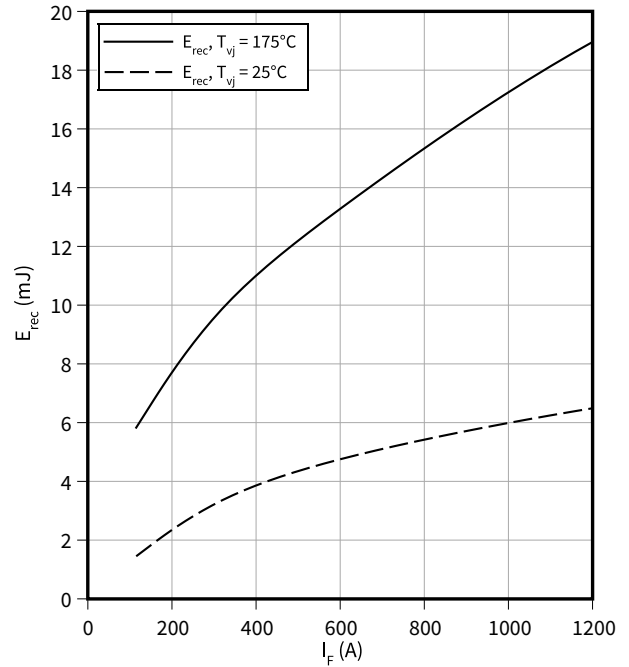

Switching losses (typical), Diode, Inverter

$E_{rec} = f(R_G)$

$V_{CE} = 400\text{ V}, I_F = 600\text{ A}$

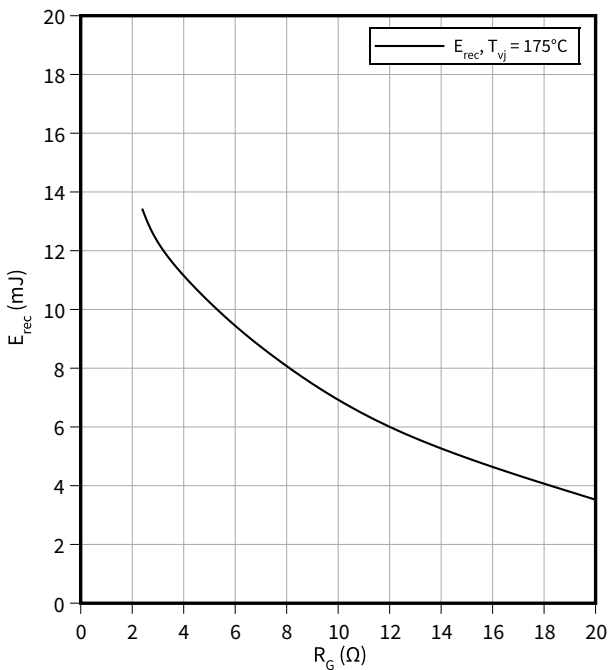

Transient thermal impedance (typical), Diode, Inverter

$Z_{th} = f(t)$

$\Delta V/\Delta t = 10\text{ dm}^3/\text{min}$, fluid = 50% water / 50% ethylenglycol, $T_f = 65\text{ °C}$

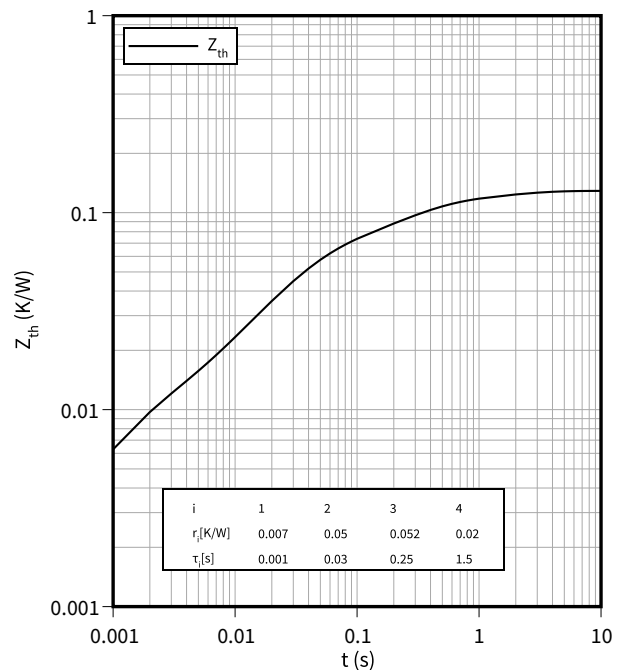

5 Characteristics diagrams

Thermal impedance (typical), Diode, Inverter

$$R_{thJF} = f(\Delta V/\Delta t)$$

$T_f = 65\text{ °C}$, fluid = 50% water / 50% ethylenglycol

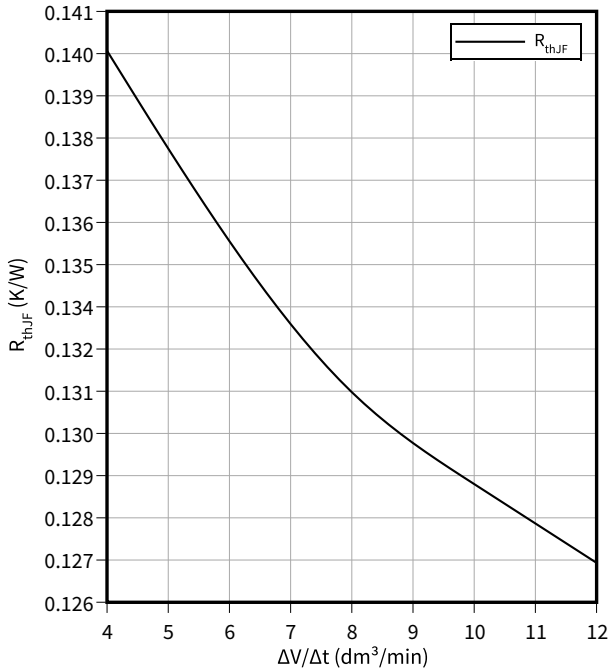

Temperature characteristic (typical), Temperature sensor

$$V_{TS} = f(T_{vj})$$

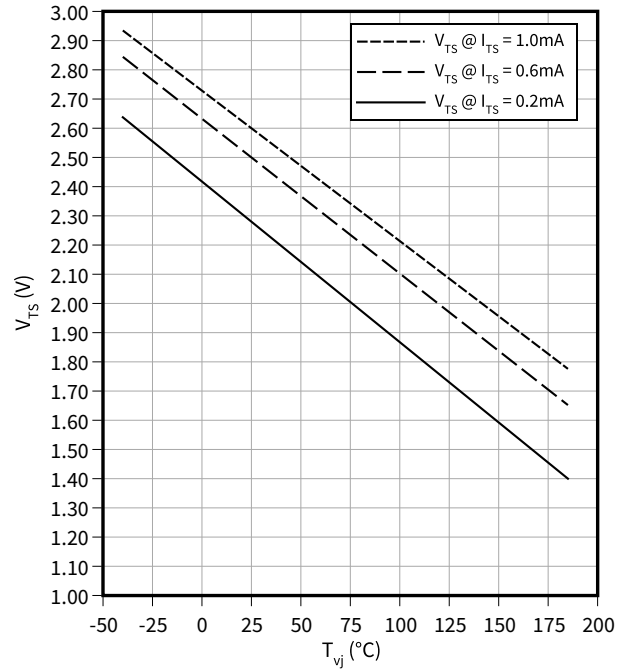

6 Circuit diagram

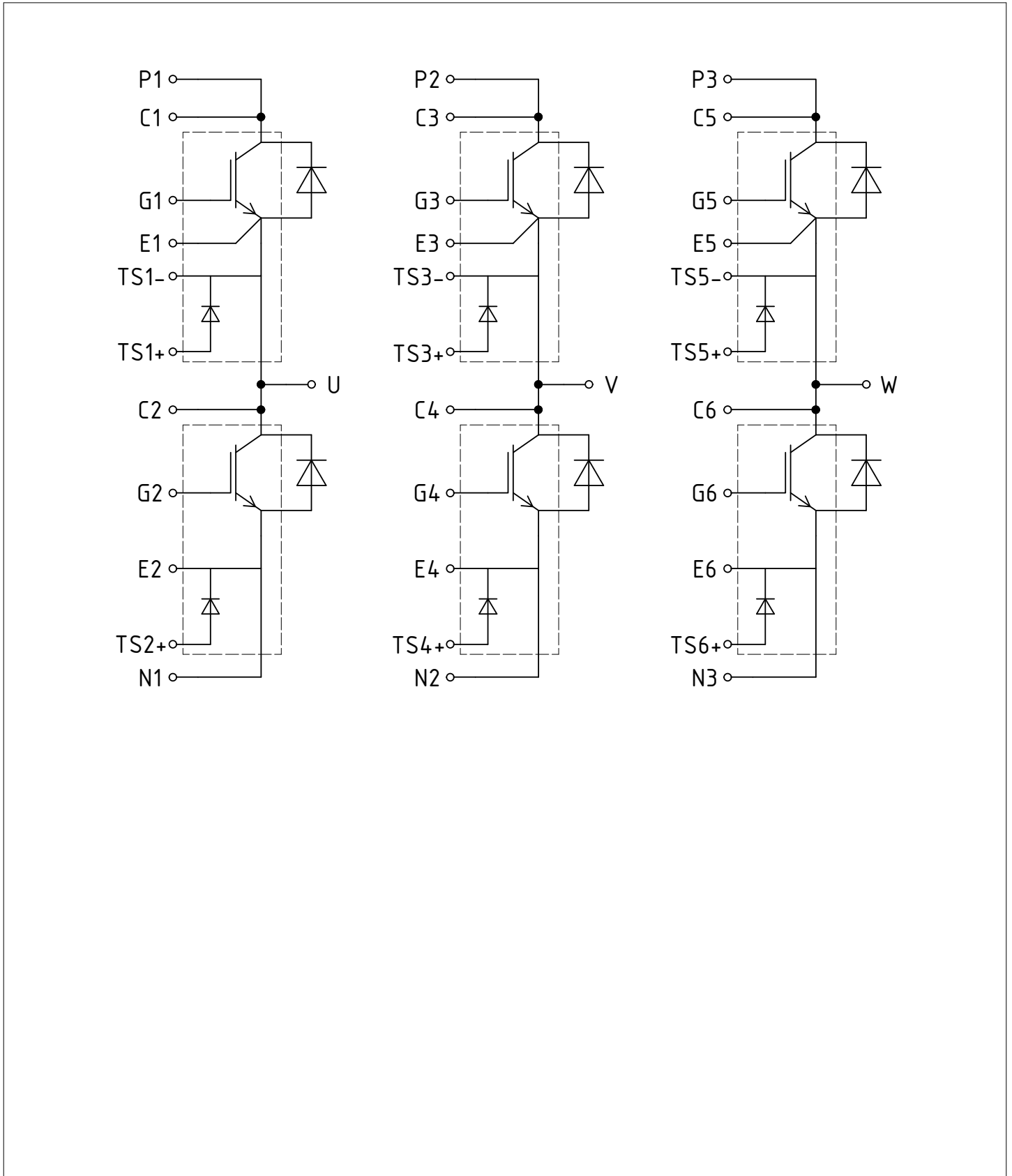

Figure 1

7 Package outlines

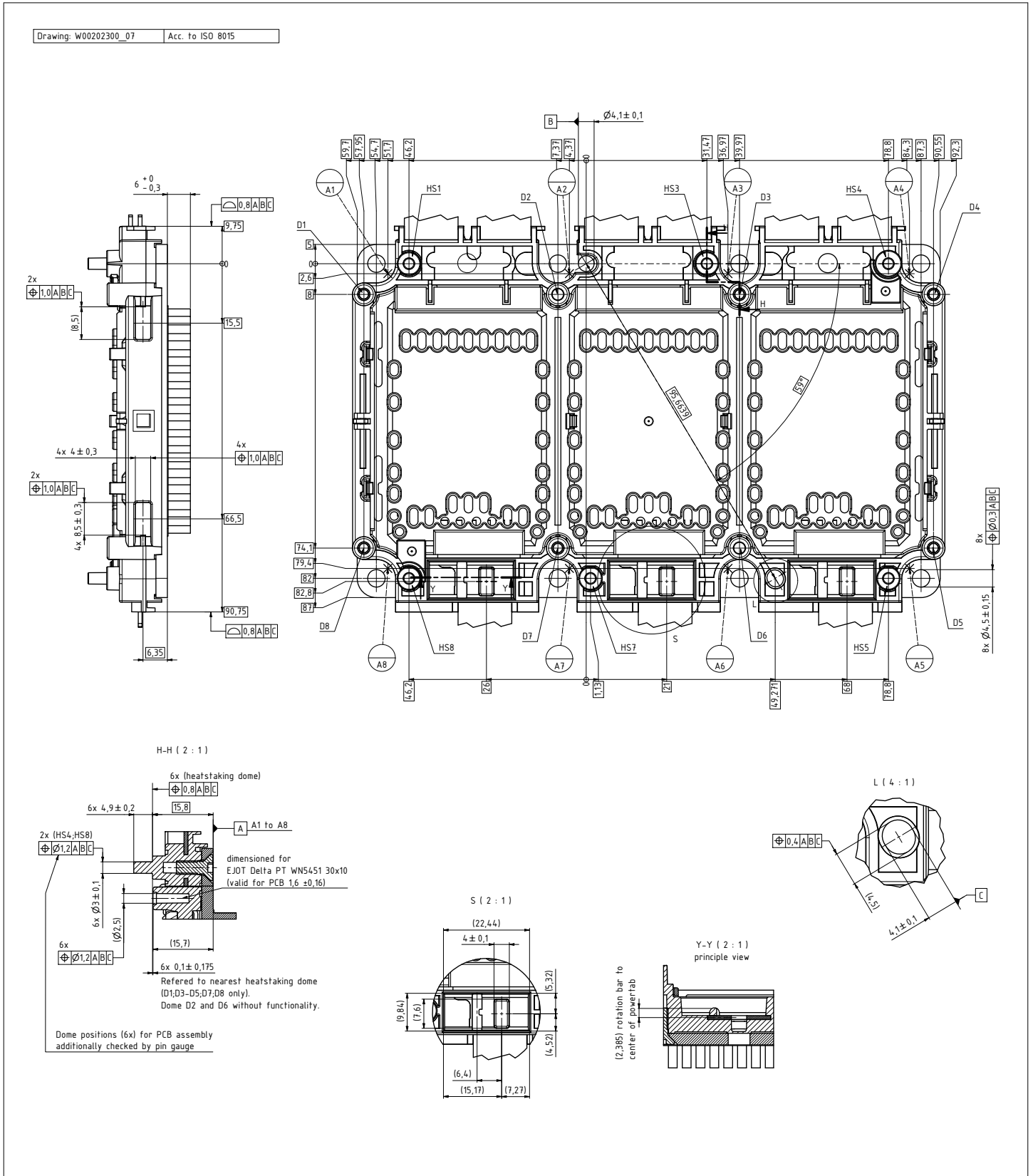

Figure 2

7 Package outlines

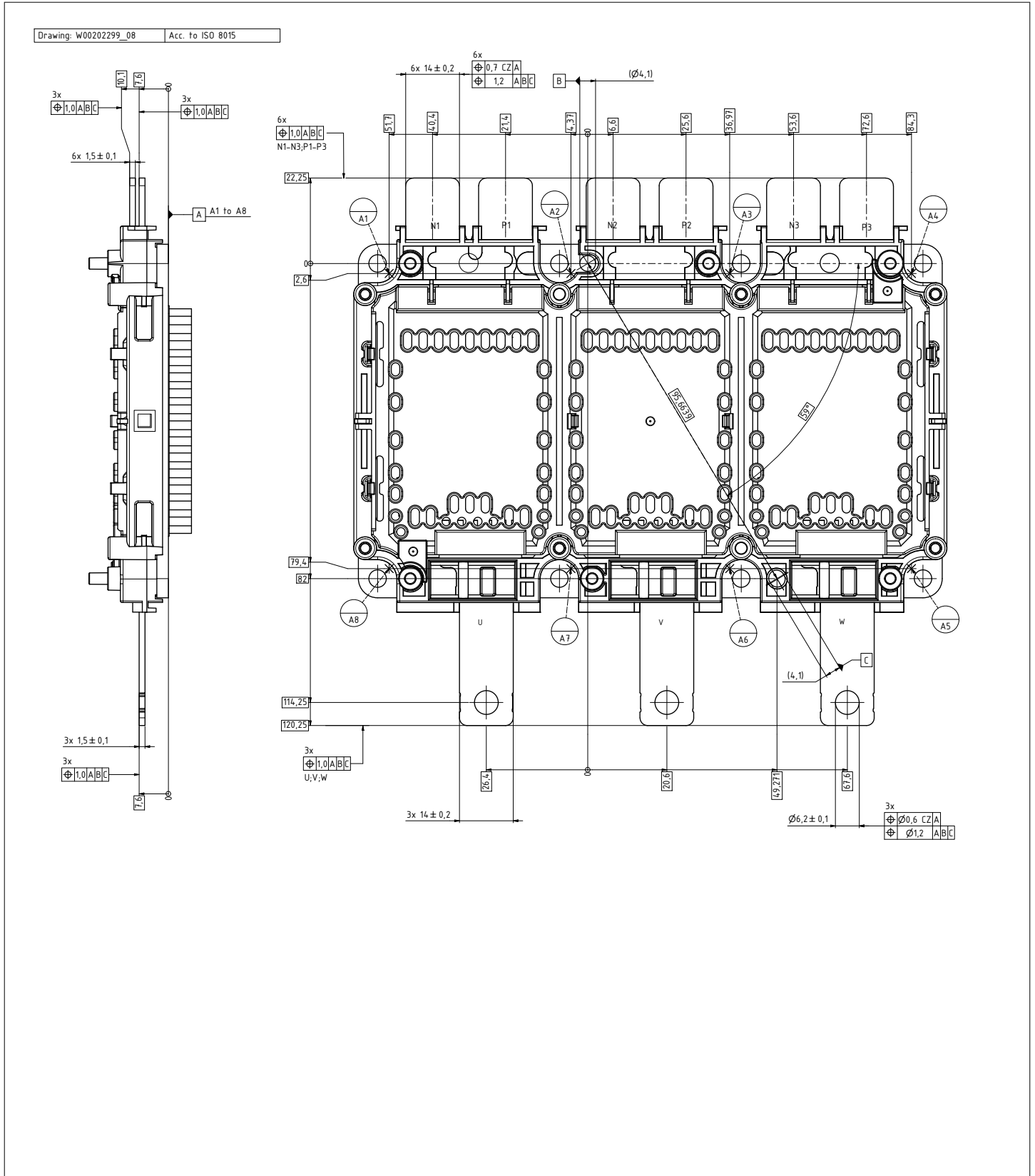

Figure 3

7 Package outlines

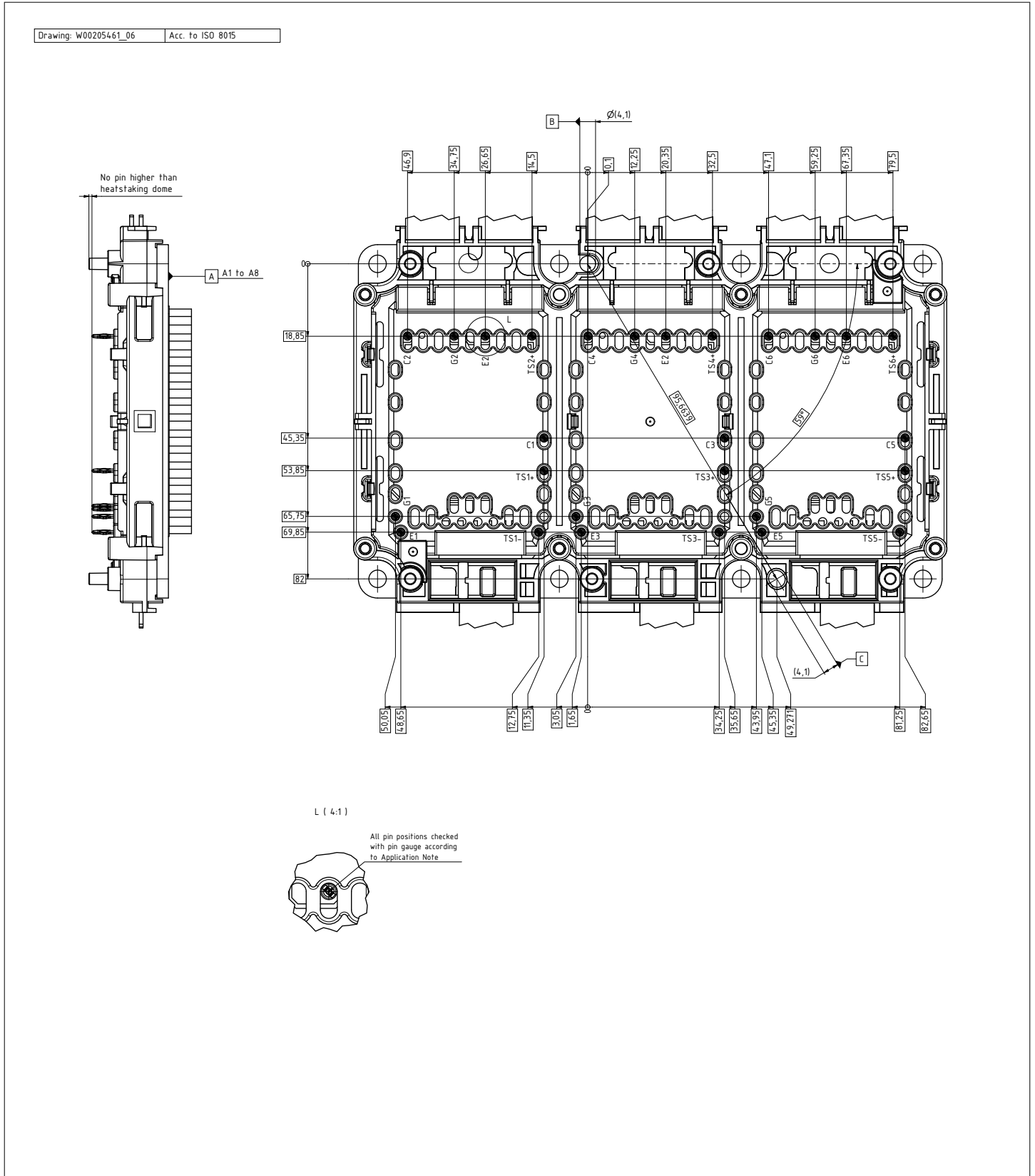

Figure 4

8 Module label code



Module label code				
Code format	Data Matrix	Barcode Code128		
Encoding	ASCII text	Code Set A		
Symbol size	16x16	23 digits		
Standard	IEC24720 and IEC16022	IEC8859-1		
Code content	<i>Content</i>	<i>Digit</i>	<i>Example</i>	
	Module serial number	1 - 5	71549	
	Module material number	6 - 11	142846	
	Production order number	12 - 19	55054991	
	Date code (production year)	20 - 21	15	
	Date code (production week)	22 - 23	30	
Example				
	71549142846550549911530		71549142846550549911530	
Packing label code				
Code format	Barcode Code128			
Encoding	Code Set A			
Symbol size	34 digits			
Standard	IEC8859-1			
Code content	<i>Content</i>	<i>Identifier</i>	<i>Digit</i>	<i>Example</i>
	Module serial number	X	2 - 9	95056609
	Module material number	1T	12 - 19	2X0003E0
	Production order number	S	21 - 25	754389
	Date code (production year)	9D	28 - 31	1139
	Date code (production week)	Q	33 - 34	15
Example				
	X950566091T2X0003E0S754389D1139Q15			

Figure 5

Revision history

Document revision	Date of release	Description of changes
0.10	2021-11-12	Initial version
0.11	2022-09-15	Updated Target datasheet
0.20	2022-12-20	Preliminary datasheet
1.00	2024-03-22	Final datasheet

Trademarks

All referenced product or service names and trademarks are the property of their respective owners.

Edition 2024-03-22

Published by

Infineon Technologies AG

81726 Munich, Germany

© 2024 Infineon Technologies AG

All Rights Reserved.

Do you have a question about any aspect of this document?

Email: erratum@infineon.com

Document reference

IFX-ABB742-004

Important notice

The information given in this document shall in no event be regarded as a guarantee of conditions or characteristics ("Beschaffheitsgarantie").

With respect to any examples, hints or any typical values stated herein and/or any information regarding the application of the product, Infineon Technologies hereby disclaims any and all warranties and liabilities of any kind, including without limitation warranties of non-infringement of intellectual property rights of any third party.

In addition, any information given in this document is subject to customer's compliance with its obligations stated in this document and any applicable legal requirements, norms and standards concerning customer's products and any use of the product of Infineon Technologies in customer's applications.

The data contained in this document is exclusively intended for technically trained staff. It is the responsibility of customer's technical departments to evaluate the suitability of the product for the intended application and the completeness of the product information given in this document with respect to such application.

Warnings

Due to technical requirements products may contain dangerous substances. For information on the types in question please contact your nearest Infineon Technologies office.

Except as otherwise explicitly approved by Infineon Technologies in a written document signed by authorized representatives of Infineon Technologies, Infineon Technologies' products may not be used in any applications where a failure of the product or any consequences of the use thereof can reasonably be expected to result in personal injury.

X-ON Electronics

Largest Supplier of Electrical and Electronic Components

Click to view similar products for [Discrete Semiconductor Modules](#) category:

Click to view products by [Infineon](#) manufacturer:

Other Similar products are found below :

[M254045V](#) [M254085](#) [DD380N16A](#) [DDB6U145N16L](#) [DR7306](#) [DZ540N26K](#) [EFG15D](#) [B484-2](#) [B485A-2](#) [B522F-2-YEC](#) [25.320.4853.1](#)
[25.320.5253.1](#) [25.334.3253.1](#) [25.334.3353.1](#) [25.350.2053.0](#) [25.352.4753.1](#) [25.522.3253.0](#) [T2180N18TOF](#) [VT](#) [T484C](#) [T485F](#) [T485H](#) [T514F](#)
[T554](#) [T582](#) [25.332.4353.1](#) [25.350.1653.0](#) [25.352.1453.0](#) [25.352.1653.0](#) [25.352.2453.0](#) [25.352.5453.1](#) [25.522.3353.0](#) [25.640.5053.0](#)
[M252532V](#) [M252555](#) [M2550TB400](#) [M471B5673EH1-CH900](#) [M505012F-YEC](#) [TD330N16AOF](#) [B512-2T-YDA](#) [TT215N22KOF](#) [V100-](#)
[35.200N](#) [V50-14.45M](#) [V72-26.150M](#) [DD700N22K](#) [DD89N16K](#) [DD98N22K](#) [MSD30-12](#) [MSKD120-16](#) [TD500N16KOF](#) [TD570N16KOF](#)