

Quasi-Resonant, 800V CoolSET™ in DSO-12 Package

Product Highlights

- Active Burst Mode to reach the lowest standby power requirement <100 mW @ no load
- Quasi resonant operation
- Digital frequency reduction for better overall system efficiency
- 800 V avalanche rugged CoolMOS™ with startup cell
- Pb-free lead plating, halogen free mold compound, RoHS compliant

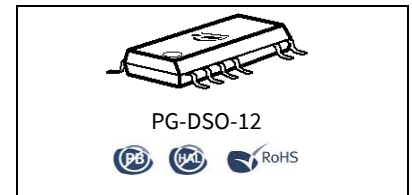

Features

- 800 V avalanche rugged CoolMOS™ with built-in startup cell
- Quasiresonant operation till very low load
- Active burst mode operation for low standby input power (< 100 mW)
- Digital frequency reduction with decreasing load for reduced switching loss
- Built-in digital soft-start
- Foldback point correction and cycle-by-cycle peak current limitation
- Maximum on/off time limitation
- Auto restart mode for VCC Overvoltage and Undervoltage protections
- Auto restart mode for overload protection
- Auto restart mode for overtemperature protection
- Latch-off mode for adjustable output overvoltage protection and transformer short-winding protection

Applications

- Adapter/Charger, Blue Ray/DVD player, Set-top Box, Digital Photo Frame
- Auxiliary power supply of Server, PC, Printer, TV, Home theater/Audio System, White Goods, etc

Description

The CoolSET™-Q1 series (ICE2QRxx80Z) is the first generation of quasi-resonant integrated power ICs. It is optimized for off-line switch mode power supply applications such as LCD monitor, DVD R/W, DVD Combo, Blue-ray DVD, set top box, etc. Operating the MOSFET switch in quasi-resonant mode, lower EMI, higher efficiency and lower voltage stress on secondary diodes are expected for the SMPS. Based on the BiCMOS technology, the CoolSET™-Q1 series has a wide operation range (up to 25 V) of IC power supply and lower power consumption. It also offers many advantages such as: a quasi-resonant operation till very low load increasing the average system efficiency compared to other conventional solutions; the Active Burst Mode operation enables ultra-low power consumption at standby mode with small and controllable output voltage ripple.

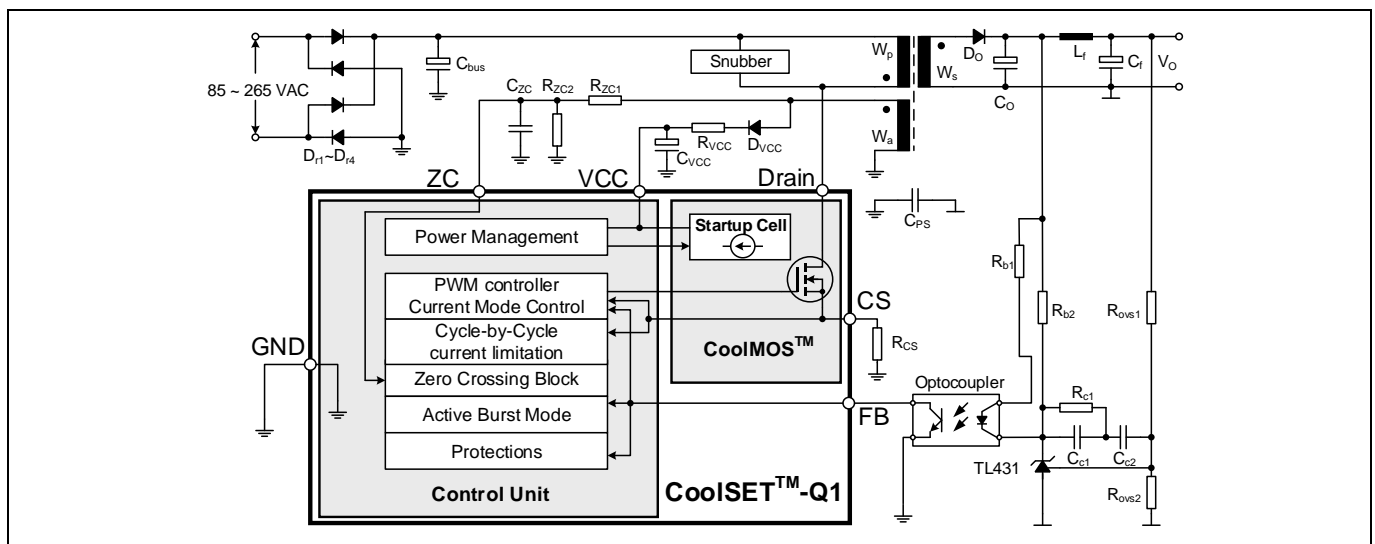

Figure 1 Typical application

| Type | Package | Marking | V _{DS} | R _{Dson} ¹ | 230V _{AC} ±15% ² | 85-265 V _{AC} ² |
|-------------|-----------|----------|-----------------|--------------------------------|--------------------------------------|-------------------------------------|
| ICE2QR4780G | PG-DSO-12 | 2QR4780G | 800 V | 4.7 Ω | 37 W | 22 W |

¹ typ at T=25°C

² Calculated maximum input power rating at Ta=50°C, Ti=125°C and with 232mm², 2 oz copper area on Drain pin as heat sink..

Pin Configuration and Functionality

Table of Contents

| | | |
|----------|--|-----------|
| 1 | Pin Configuration and Functionality | 3 |
| 2 | Representative Block Diagram | 4 |
| 3 | Functional Description | 5 |
| 3.1 | Introduction..... | 5 |
| 3.2 | Soft-start..... | 5 |
| 3.3 | Normal Operation | 6 |
| 3.3.1 | Digital Frequency Reduction | 6 |
| 3.3.1.1 | Up/down counter | 6 |
| 3.3.1.2 | Zero crossing (ZC counter) | 7 |
| 3.3.1.3 | Ringing suppression time | 8 |
| 3.3.1.4 | Switch on determination | 8 |
| 3.3.1.5 | Switch off determination..... | 8 |
| 3.4 | Current Limitation..... | 9 |
| 3.4.1 | Foldback Point Correction..... | 9 |
| 3.5 | Active Burst Mode..... | 10 |
| 3.5.1 | Entering Active Burst Mode Operation | 10 |
| 3.5.2 | During Active Burst Mode Operation | 10 |
| 3.5.3 | Leaving Active Burst Mode Operation | 11 |
| 3.6 | Protection Functions..... | 12 |
| 4 | Electrical Characteristics | 13 |
| 4.1 | Absolute Maximum Ratings | 13 |
| 4.2 | Operating Range..... | 14 |
| 4.3 | Characteristics..... | 14 |
| 4.3.1 | Supply Section | 14 |
| 4.3.2 | Internal Voltage Reference | 15 |
| 4.3.3 | PWM Section..... | 15 |
| 4.3.4 | Current Sense | 15 |
| 4.3.5 | Soft Start..... | 15 |
| 4.3.6 | Foldback Point Correction..... | 16 |
| 4.3.7 | Digital Zero Crossing..... | 16 |
| 4.3.8 | Active Burst Mode | 17 |
| 4.3.9 | Protection..... | 17 |
| 4.3.10 | CoolMOS™ Section | 18 |
| 5 | CoolMOS™ Performance Characteristics..... | 19 |
| 6 | Input Power Curve | 21 |
| 7 | Outline Dimension | 22 |
| 8 | Marking | 23 |
| | Revision History | 23 |

Pin Configuration and Functionality

1 Pin Configuration and Functionality

Table 1 Pin definitions and functions

| Pin | Symbol | Function |
|------------|--------|--|
| 1 | ZC | ZC (Zero Crossing) At this pin, the voltage from the auxiliary winding after a time delay circuit is applied. Internally, this pin is connected to the zero-crossing detector for switch-on determination. Additionally, the output overvoltage detection is realized by comparing the voltage V_{ZC} with an internal preset threshold. |
| 2 | FB | FB (Feedback) Normally an external capacitor is connected to this pin for a smooth voltage V_{FB} . Internally this pin is connected to the PWM signal generator block for switch-off determination (together with the current sensing signal), to the digital signal processing block for the frequency reduction with decreasing load during normal operation, and to the Active Burst Mode controller block for entering Active Burst Mode operation determination and burst ratio control during Active Burst Mode operation. Additionally, the open-loop / over-load protection is implemented by monitoring the voltage at this pin. |
| 3, 9, 10 | N.C. | Not Connected |
| 4 | CS | CS (Current Sense/800V CoolMOS™ Source) This pin is connected to the shunt resistor for the primary current sensing externally and to the PWM signal generator block for switch-off determination (together with the feedback voltage) internally. Moreover, short-winding protection is realized by monitoring the voltage V_{CS} during on-time of the main power switch. |
| 5, 6, 7, 8 | Drain | 800V CoolMOS™ Drain Pin Drain is the connection to the Drain of the integrated CoolMOS™. |
| 11 | VCC | VCC (Power supply) VCC pin is the positive supply of the IC. The operating range is between V_{VCCoff} and V_{VCCOVp} . |
| 12 | GND | GND (Ground) This is the common ground of the controller. |

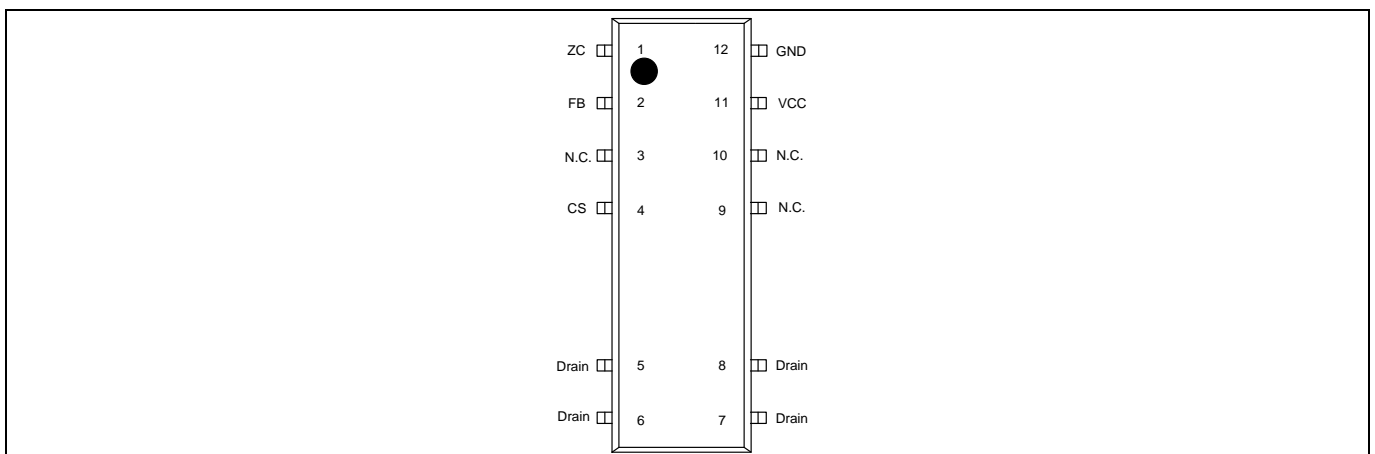

Figure 2 Pin configuration PG-DSO-12(top view)

Representative Block Diagram

2 Representative Block Diagram

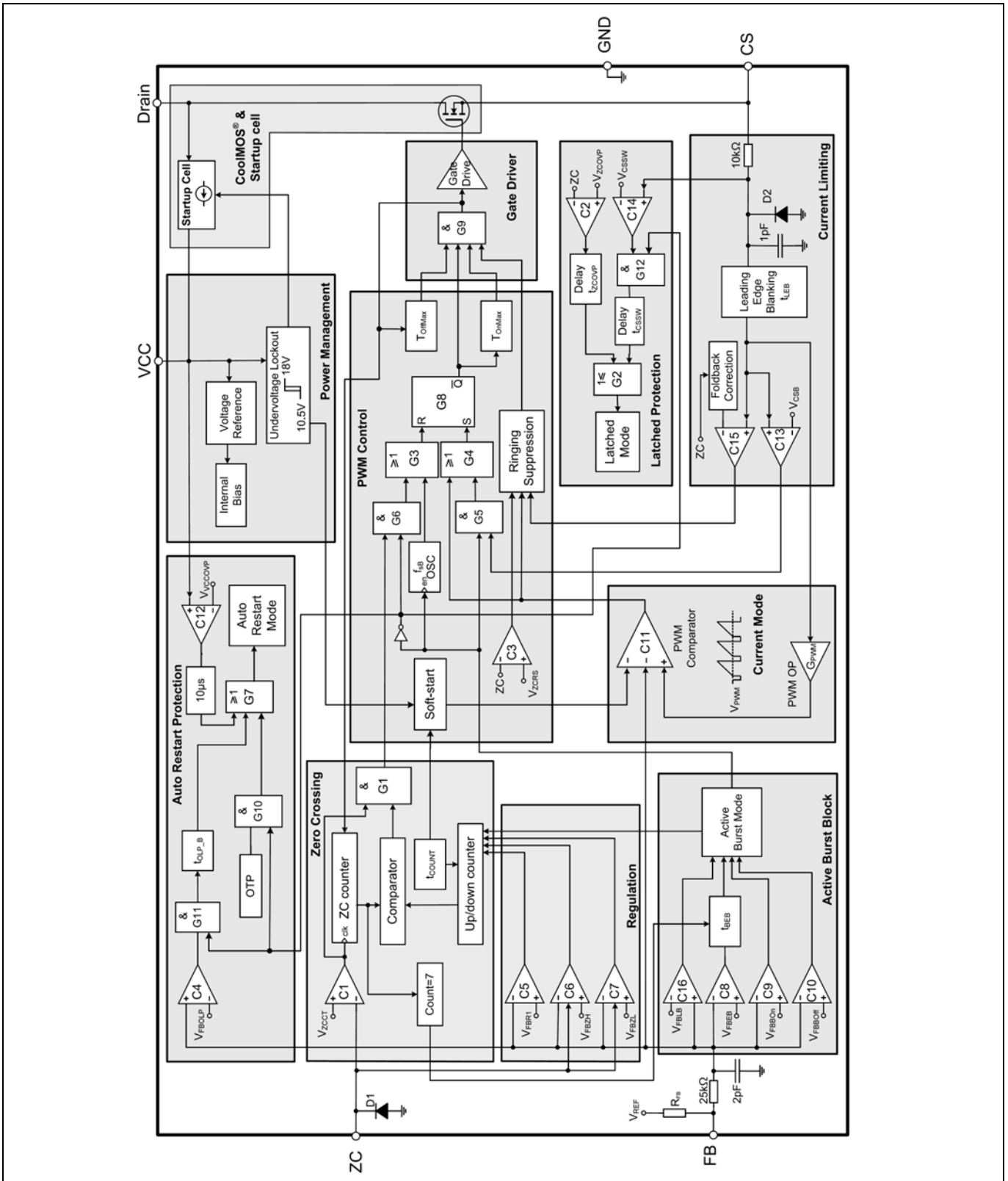

Figure 3 Representative Block Diagram

Functional Description

3 Functional Description

3.1 Introduction

In ICE2QR4780G, a startup cell is integrated into the CoolMOS™. As shown in Figure 3, the start cell consists of a high voltage device and a controller, whereby the high voltage device is controlled by the controller. The startup cell provides a pre-charging of the VCC capacitor till VCC voltage reaches the VCC turned-on threshold V_{VCCon} and the IC begins to operate.

Once the mains input voltage is applied, a rectified voltage shows across the capacitor C_{bus} . The high voltage device provides a current to charge the VCC capacitor C_{VCC} . Before the VCC voltage reaches a certain value, the amplitude of the current through the high voltage device is only determined by its channel resistance and can be as high as several mA. After the VCC voltage is high enough, the controller controls the high voltage device so that a constant current around 1 mA is provided to charge the VCC capacitor further, until the VCC voltage exceeds the turned-on threshold V_{VCCon} . As shown as the time phase I in Figure 4, the VCC voltage increase near linearly and the charging speed is independent of the mains voltage level.

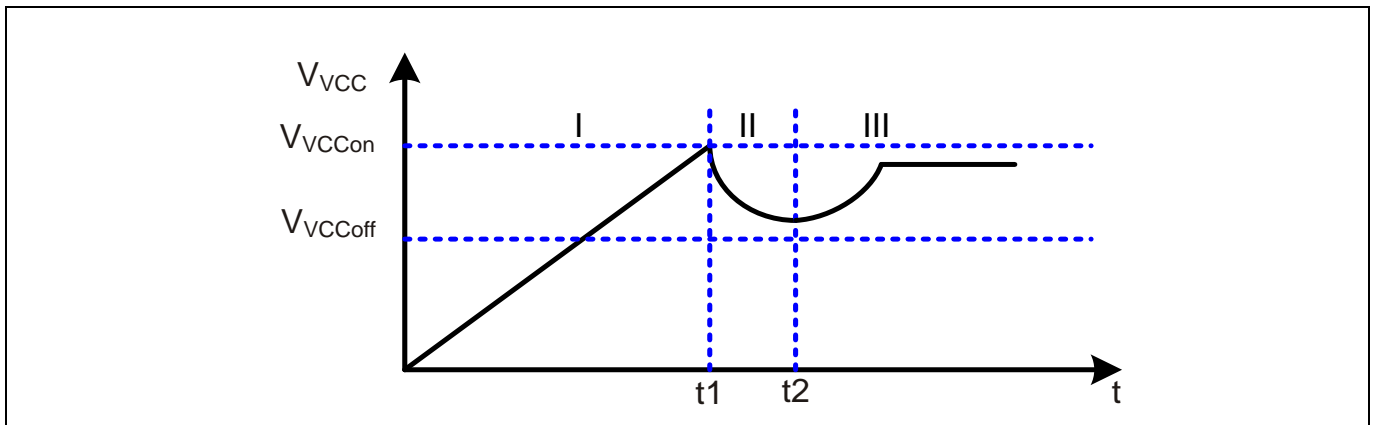

Figure 4 VCC voltage at start up

The time taking for the VCC pre-charging can then be approximately calculated as:

$$t_1 = \frac{V_{VCCon} \cdot C_{VCC}}{I_{VCCcharge2}} \tag{1}$$

where $I_{VCCcharge2}$ is the charging current from the startup cell which is 1.05 mA, typically.

When the VCC voltage exceeds the VCC turned-on threshold V_{VCCon} at time t_1 , the startup cell is switched off and the IC begins to operate with soft-start. Due to power consumption of the IC and the fact that there is still no energy from the auxiliary winding to charge the VCC capacitor before the output voltage is built up, the VCC voltage drops (Phase II). Once the output voltage is high enough, the VCC capacitor receives the energy from the auxiliary winding from the time point t_2 onward. The VCC then will reach a constant value depending on output load.

3.2 Soft-start

As shown in Figure 5, at the time t_{on} , the IC begins to operate with a soft-start. By this soft-start the switching stresses for the switch, diode and transformer are minimized. The soft-start implemented in CoolSET™ Q1 is a digital time-based function. The preset soft-start time is t_{ss} (12 ms) with 4 steps. If not limited by other functions, the peak voltage on CS pin will increase step by step from 0.32 V to 1 V finally.

Functional Description

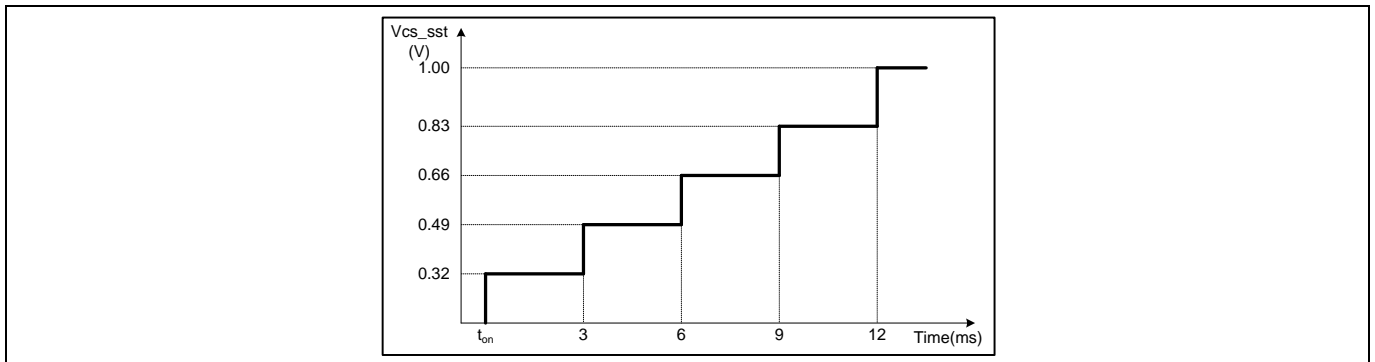

Figure 5 Maximum current sense voltage during soft start

3.3 Normal Operation

The PWM controller during normal operation consists of a digital signal processing circuit including an up/down counter, a zero-crossing counter (ZC counter) and a comparator, and an analog circuit including a current measurement unit and a comparator. The switch-on and -off time points are each determined by the digital circuit and the analog circuit, respectively. As input information for the switch-on determination, the zero-crossing input signal and the value of the up/down counter are needed, while the feedback signal V_{FB} and the current sensing signal V_{CS} are necessary for the switch-off determination. Details about the full operation of the PWM controller in normal operation are illustrated in the following paragraphs.

3.3.1 Digital Frequency Reduction

As mentioned above, the digital signal processing circuit consists of an up/down counter, a ZC counter and a comparator. These three parts are key to implement digital frequency reduction with decreasing load. In addition, a ringing suppression time controller is implemented to avoid mis-triggering by the high frequency oscillation, when the output voltage is very low under conditions such as soft start period or output short circuit. Functionality of these parts is described as in the following.

3.3.1.1 Up/down counter

The up/down counter stores the number of the zero crossing where the main power switch is switched on after demagnetization of the transformer. This value is fixed according to the feedback voltage, V_{FB} , which contains information about the output power. Indeed, in a typical peak current mode control, a high output power results in a high feedback voltage, and a low output power leads to a low regulation voltage. Hence, according to V_{FB} , the value in the up/down counter is changed to vary the power MOSFET off-time according to the output power. In the following, the variation of the up/down counter value according to the feedback voltage is explained.

The feedback voltage V_{FB} is internally compared with three threshold voltages V_{FBZL} , V_{FBZH} and V_{FBR1} , at each clock period of 48 ms. The up/down counter counts then upward, keep unchanged or count downward, as shown in Table 2.

Functional Description

Table 2

| V_{FB} | up/down counter action |
|--|----------------------------------|
| Always lower than V_{FBZL} | Count upwards till 7 |
| Once higher than V_{FBZL} , but always lower than V_{FBZH} | Stop counting, no value changing |
| Once higher than V_{FBZH} , but always lower than V_{FBR1} | Count downwards till 1 |
| Once higher than V_{FBR1} | Set up/down counter to 1 |

In the ICE2QR4780G, the number of zero crossing is limited to 7. Therefore, the counter varies between 1 and 7, and any attempt beyond this range is ignored. When V_{FB} exceeds V_{FBR1} voltage, the up/down counter is reset to 1, in order to allow the system to react rapidly to a sudden load increase. The up/down counter value is also reset to 1 at the start-up time, to ensure an efficient maximum load start up. Figure 6 shows some examples on how up/down counter is changed according to the feedback voltage over time.

The use of two different thresholds V_{FBZL} and V_{FBZH} to count upward or downward is to prevent frequency jittering when the feedback voltage is close to the threshold point. However, for a stable operation, these two thresholds must not be affected by the foldback current limitation (see 3.4.1), which limits the V_{CS} voltage. Hence, to prevent such situation, the threshold voltages, V_{FBZL} and V_{FBZH} , are changed internally depending on the line voltage levels.

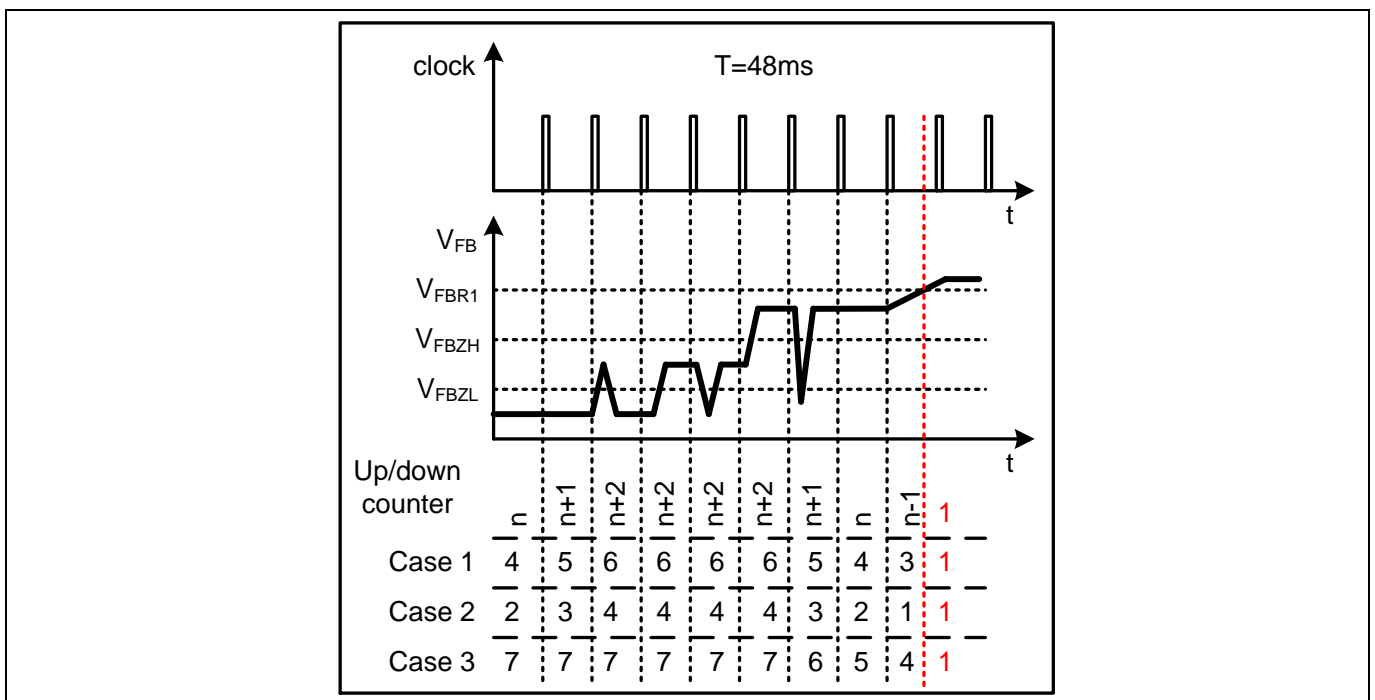

Figure 6 Up/down counter operation

3.3.1.2 Zero crossing (ZC counter)

In the system, the voltage from the auxiliary winding is applied to the zero-crossing pin through a RC network, which provides a time delay to the voltage from the auxiliary winding. Internally this pin is connected to a clamping network, a zero-crossing detector, an output overvoltage detector and a ringing suppression time controller.

During on-state of the power switch a negative voltage applies to the ZC pin. Through the internal clamping network, the voltage at the pin is clamped to certain level.

Functional Description

The ZC counter has a minimum value of 0 and maximum value of 7. After the internal MOSFET is turned off, every time when the falling voltage ramp of on ZC pin crosses the V_{ZCCT} (100 mV) threshold, a zero crossing is detected and ZC counter will increase by 1. It is reset every time after the DRIVER output is changed to high.

The voltage V_{ZC} is also used for the output overvoltage protection. Once the voltage at this pin is higher than the threshold V_{ZCOVP} during off-time of the main switch, the IC is latched off after a fixed blanking time.

To achieve the switch-on at voltage valley, the voltage from the auxiliary winding is fed to a time delay network (the RC network consists of D_{ZC} , R_{ZC1} , R_{ZC2} and C_{ZC} as shown in Figure 1) before it is applied to the zero-crossing detector through the ZC pin. The needed time delay to the main oscillation signal Δt should be approximately one fourth of the oscillation period, T_{osc} (by transformer primary inductor and drain-source capacitor) minus the propagation delay from the detected zero-crossing to the switch-on of the main switch t_{delay} .

$$\Delta t = \frac{T_{osc}}{4} - t_{delay} \quad (2)$$

This time delay should be matched by adjusting the time constant of the RC network which is calculated as:

$$\Delta t = \frac{T_{osc}}{4} - t_{delay} \quad (3)$$

3.3.1.3 Ringing suppression time

After MOSFET is turned off, there will be some oscillation on V_{DS} , which will also appear on the voltage on ZC pin. To avoid mis-triggering by such oscillations to turn on the MOSFET, a ringing suppression timer is implemented. This suppression time is depended on the voltage V_{ZC} . If the voltage V_{ZC} is lower than the threshold V_{ZCRS} , a longer preset time t_{ZCRS2} is applied. However, if the voltage V_{ZC} is higher than the threshold, a shorter time t_{ZCRS1} is set.

3.3.1.4 Switch on determination

After the gate drive goes to low, it cannot be changed to high during ring suppression time.

After ring suppression time, the gate drive can be turned on when the ZC counter value is higher or equal to up/down counter value.

However, it is also possible that the oscillation between primary inductor and drain-source capacitor damps very fast and IC cannot detect enough zero crossings and ZC counter value will not be high enough to turn on the gate drive. In this case, a maximum off time is implemented. After gate drive has been remained off for the period of T_{OffMax} , the gate drive will be turned on again regardless of the counter values and V_{ZC} . This function can effectively prevent the switching frequency from going lower than 20 kHz. Otherwise it will cause audible noise during start up.

3.3.1.5 Switch off determination

In the converter system, the primary current is sensed by an external shunt resistor, which is connected between low-side terminal of the main power switch and the common ground. The sensed voltage across the shunt resistor V_{CS} is applied to an internal current measurement unit, and its output voltage V_1 is compared with the regulation voltage V_{FB} . Once the voltage V_1 exceeds the voltage V_{FB} , the output flip-flop is reset. As a result, the main power switch is switched off. The relationship between the V_1 and the V_{CS} is described by:

$$V_1 = G_{PWM} \cdot V_{CS} + V_{PWM} \quad (4)$$

Functional Description

To avoid mis-triggering caused by the voltage spike across the shunt resistor at the turn on of the main power switch, a leading edge blanking time, t_{LEB} , is applied to the output of the comparator. In other words, once the gate drive is turned on, the minimum on time of the gate drive is the leading edge blanking time.

In addition, there is a maximum on time, t_{ONMax} , limitation implemented in the IC. Once the gate drive has been in high state longer than the maximum on time, it will be turned off to prevent the switching frequency from going too low because of long on time.

3.4 Current Limitation

There is a cycle by cycle current limitation realized by the current limit comparator to provide an over-current detection. The source current of the MOSFET is sensed via a sense resistor R_{CS} . By means of R_{CS} the source current is transformed to a sense voltage V_{CS} which is fed into the pin CS. If the voltage V_{CS} exceeds an internal voltage limit, adjusted according to the Mains voltage, the comparator immediately turns off the gate drive.

To prevent the Current Limitation process from distortions caused by leading edge spikes, a Leading Edge Blanking time (t_{LEB}) is integrated in the current sensing path.

A further comparator is implemented to detect dangerous current levels (V_{CSSW}) which could occur if one or more transformer windings are shorted or if the secondary diode is shorted. To avoid an accidental latch off, a spike blanking time of t_{CSSW} is integrated in the output path of the comparator.

3.4.1 Foldback Point Correction

When the main bus voltage increases, the switch on time becomes shorter and therefore the operating frequency is also increased. As a result, for a constant primary current limit, the maximum possible output power is increased which is beyond the converter design limit.

To avoid such a situation, the internal foldback point correction circuit varies the V_{CS} voltage limit according to the bus voltage. This means the V_{CS} will be decreased when the bus voltage increases. To keep a constant maximum input power of the converter, the required maximum V_{CS} versus various input bus voltage can be calculated, which is shown in Figure 7.



Figure 7 Variation of the V_{CS} limit voltage according to the I_{ZC} current

According to the typical application circuit, when MOSFET is turned on, a negative voltage proportional to bus voltage will be coupled to auxiliary winding. Inside CoolSET™ Q1, an internal circuit will clamp the voltage on ZC pin to nearly 0 V. As a result, the current flowing out from ZC pin can be calculated as

Functional Description

$$I_{ZC} = \frac{V_{BUS} \cdot N_a}{R_{ZC1} \cdot N_p} \tag{5}$$

When this current is higher than I_{ZC_FS} , the amount of current exceeding this threshold is used to generate an offset to decrease the maximum limit on V_{CS} . Since the ideal curve shown in Figure 7 is a nonlinear one, a digital block in CoolSET™ Q1 is implemented to get a better control of maximum output power. Additional advantage to use digital circuit is the production tolerance is smaller compared to analog solutions. The typical maximum limit on V_{CS} versus the ZC current is shown in Figure 8.

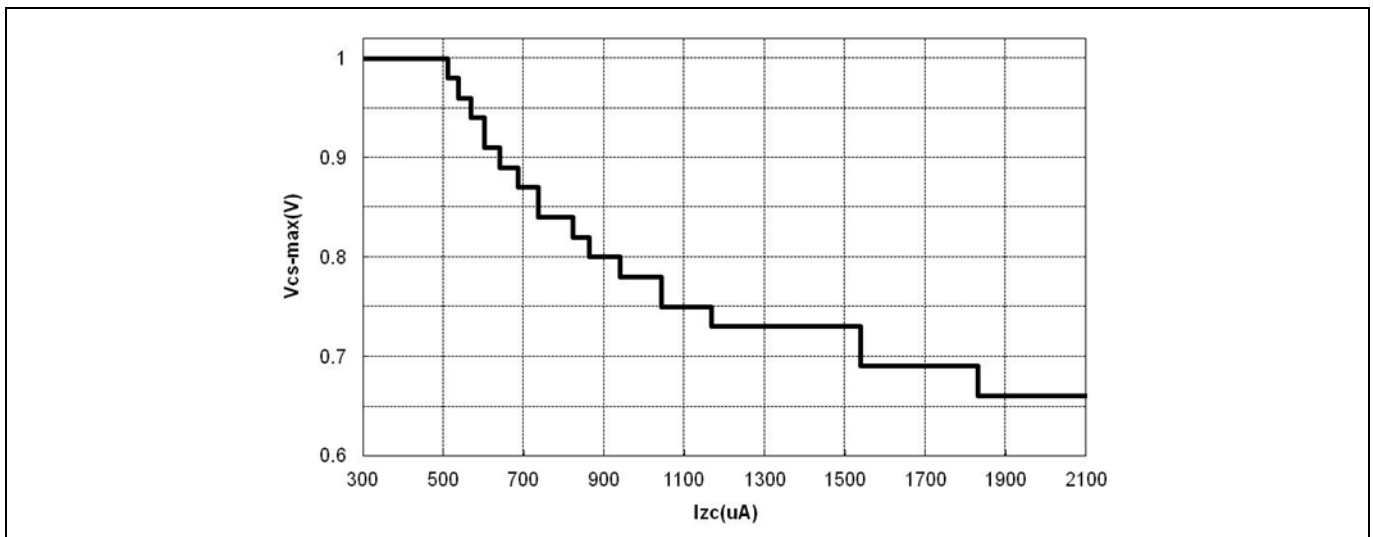

Figure 8 V_{CS_max} versus I_{ZC}

3.5 Active Burst Mode

At light load condition, the IC enters Active Burst Mode operation to minimize the power consumption. Details about Active Burst Mode operation are explained in the following paragraphs.

3.5.1 Entering Active Burst Mode Operation

For determination of entering Active Burst Mode operation, three conditions apply:

- the feedback voltage is lower than the threshold of V_{FBEB} (1.25 V). Accordingly, the peak current sense voltage across the shunt resistor is 0.17 V;
- the up/down counter is N_{ZC_ABM} (7) and
- a certain blanking time t_{BEB} (24 ms).

Once all of these conditions are fulfilled, the Active Burst Mode flip-flop is set and the controller enters Active Burst Mode operation. This multi-condition determination for entering Active Burst Mode operation prevents mis-triggering of entering Active Burst Mode operation, so that the controller enters Active Burst Mode operation only when the output power is really low during the preset blanking time.

3.5.2 During Active Burst Mode Operation

After entering the Active Burst Mode the feedback voltage rises as V_{OUT} starts to decrease due to the inactive PWM section. One comparator observes the feedback signal if the voltage level V_{FBBOn} (3.6 V) is exceeded. In that case the internal circuit is again activated by the internal bias to start with switching.

Turn-on of the power MOSFET is triggered by the timer. The PWM generator for Active Burst Mode operation composes of a timer with a fixed frequency of f_{sB} (52 kHz, typical) and an analog comparator. Turn-off is

Functional Description

resulted if the voltage across the shunt resistor at CS pin hits the threshold V_{csB} (0.34 V). A turn-off can also be triggered if the duty ratio exceeds the maximal duty ratio D_{maxB} (50%). In operation, the output flip-flop will be reset by one of these signals which come first.

If the output load is still low, the feedback signal decreases as the PWM section is operating. When feedback signal reaches the low threshold V_{FBBOff} (3.0 V), the internal bias is reset again and the PWM section is disabled until next time regulation signal increases beyond the V_{FBBOOn} (3.6 V) threshold. If working in Active Burst Mode the feedback signal is changing like a saw tooth between V_{FBBOff} and V_{FBBOOn} shown in Figure 9.

3.5.3 Leaving Active Burst Mode Operation

The feedback voltage immediately increases if there is a high load jump. This is observed by a comparator. As the current limit is 34% during Active Burst Mode a certain load is needed so that feedback voltage can exceed V_{FBLB} (4.5 V). After leaving active burst mode, maximum current can now be provided to stabilize V_{OUT} . In addition, the up/down counter will be set to 1 immediately after leaving Active Burst Mode. This is helpful to decrease the output voltage undershoot.

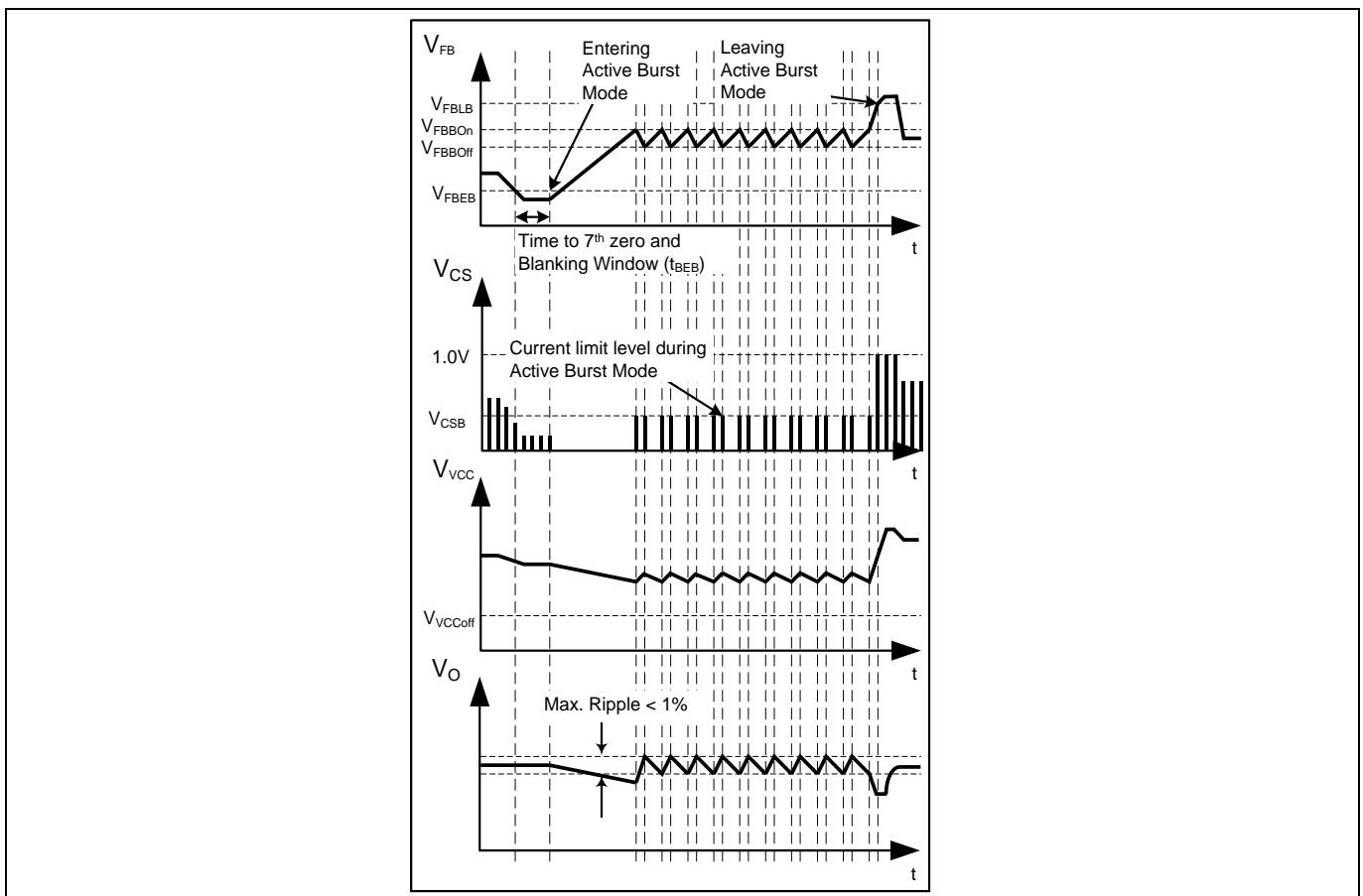

Figure 9 Signals in Active Burst Mode

Functional Description

3.6 Protection Functions

The IC provides full protection functions. The following table summarizes these protection functions.

During operation, the VCC voltage is continuously monitored. In case of an under-voltage or an over-voltage, the IC is reset and the main power switch is then kept off. After the VCC voltage falls below the threshold V_{VCCoff} , the startup cell is activated. The VCC capacitor is then charged up. Once the voltage exceeds the threshold V_{VCCon} , the IC begins to operate with a new soft-start.

Table 3

| Protection Function | Failure Condition | Protection Mode |
|--|--|-----------------|
| VCC Overvoltage | $V_{VCC} > 25\text{ V}$ & last for 10 μs (normal mode only) | Auto Restart |
| VCC Undervoltage/ Short Optocoupler | $V_{VCC} < 10.5\text{ V}$ | Auto Restart |
| Overload/Open Loop | $V_{FB} > 4.5\text{ V}$ & last for 30 ms | Auto Restart |
| Over Temperature (Controller Junction) | $T_J > 140\text{ }^\circ\text{C}$ | Auto Restart |
| Output Overvoltage | $V_{ZCOVP} > 3.7\text{ V}$ & last for 100 μs | Latch |
| Short Winding | $V_{CSSW} > 1.68\text{ V}$ & last for 190 ns | Latch |

In case of open control loop or output over load, the feedback voltage will be pulled up. After a blanking time of t_{OLP_B} (30 ms), the IC enters auto-restart mode. The blanking time here enables the converter to provide a peak power in case the increase in V_{FB} is due to a sudden load increase. This output over load protection is disabled during burst mode.

During off-time of the power switch, the voltage at the zero-crossing pin is monitored for output over-voltage detection. If the voltage is higher than the preset threshold V_{ZCOVP} , the IC is latched off after the preset blanking time t_{ZCOVP} . This latch off mode can only be reset if the $V_{VCC} < V_{VCCPD}$.

If the junction temperature of IC controller exceeds T_{jcon} (130 °C), the IC enters into OTP auto restart mode. This OTP is disabled during burst mode.

If the voltage at the current sensing pin is higher than the preset threshold V_{CSSW} during on-time of the power switch, the IC is latched off. This is short-winding protection. The short winding protection is disabled during burst mode.

During latch-off protection mode, the VCC voltage drops to V_{VCCoff} (10.5 V) and then the startup cell is activated. The VCC voltage is then charged to V_{VCCon} (18 V). The startup cell is shut down again. This action repeats again and again.

There is also a maximum on time limitation implemented inside the CoolSET™ Q1. Once the gate voltage is high and longer than t_{OnMax} , the switch is turned off immediately.

Electrical Characteristics

4 Electrical Characteristics

Note: All voltages are measured with respect to ground (Pin 12). The voltage levels are valid if other ratings are not violated.

4.1 Absolute Maximum Ratings

Note: Absolute maximum ratings are defined as ratings, which when being exceeded may lead to destruction of the integrated circuit. For the same reason make sure, that any capacitor that will be connected to pin 11 (VCC) is discharged before assembling the application circuit.

Table 4 Absolute Maximum Ratings

| Parameter | Symbol | Limit Values | | Unit | Remarks |
|--|---------------|--------------|-------|------------------|------------------------------------|
| | | min. | max. | | |
| Drain Source Voltage | V_{DS} | - | 800 | A | $T_j=25\text{ }^\circ\text{C}$ |
| Pulse drain current, t_p limited by T_{jmax} | I_{D_Plus} | - | 1.95 | A | |
| Avalanche energy, repetitive t_{AR} limited by max. $T_j=150\text{ }^\circ\text{C}^1$ | E_{AR} | - | 0.024 | mJ | |
| Avalanche current, repetitive t_{AR} limited by max. $T_j=150\text{ }^\circ\text{C}^1$ | I_{AR} | - | 0.95 | A | |
| VCC Supply Voltage | V_{VCC} | -0.3 | 27 | V | |
| FB Voltage | V_{FB} | -0.3 | 5.5 | V | |
| ZC Voltage | V_{ZC} | -0.3 | 5.5 | V | |
| CS Voltage | V_{CS} | -0.3 | 5.5 | V | |
| Maximum current out from ZC pin | I_{ZCmax} | 3 | - | mA | |
| Junction Temperature | T_j | -40 | 150 | $^\circ\text{C}$ | Controller & CoolMOS™ |
| Storage Temperature | T_s | -55 | 150 | $^\circ\text{C}$ | |
| Thermal Resistance (Junction–Ambient) | R_{thJA} | - | 110 | K/W | |
| Soldering temperature, wavesoldering only allowed at leads | T_{sold} | - | 260 | $^\circ\text{C}$ | 1.6mm (0.063in.) from case for 10s |
| ESD Capability (incl. Drain Pin) | V_{ESD} | - | 2 | kV | Human body model ² |

¹ Repetitive avalanche causes additional power losses that can be calculated as $P_{AV}=E_{AR} \cdot f$

² According to EIA/JESD22-A114-B (discharging a 100 pF capacitor through a 1.5 kW series resistor)

Electrical Characteristics

4.2 Operating Range

Note: Within the operating range the IC operates as described in the functional description.

Table 5 Operating Range

| Parameter | Symbol | Limit Values | | Unit | Remarks |
|------------------------------------|-----------------------|---------------------|---------------------|------|---------|
| | | min. | max. | | |
| VCC Supply Voltage | V _{VCC} | V _{VCCoff} | V _{VCCOVp} | V | |
| Junction Temperature of Controller | T _{JCon} | -40 | 130 | °C | |
| Junction Temperature of CoolMOS™ | T _{JCoolMOS} | -40 | 150 | °C | |

4.3 Characteristics

4.3.1 Supply Section

Note: The electrical characteristics involve the spread of values within the specified supply voltage and junction temperature range T_J from - 40 °C to 125 °C. Typical values represent the median values, which are related to 25°C. If not otherwise stated, a supply voltage of VCC = 17 V is assumed.

Table 6 Supply Section

| Parameter | Symbol | Limit Values | | | Unit | Test Condition |
|--|-------------------------|--------------|------|------|------|--|
| | | min. | typ. | max. | | |
| Start Up Current | I _{VCCstart} | - | 300 | 550 | μ A | V _{VCC} = V _{VCCcon} - 0.2 V |
| VCC Charge Current | I _{VCCcharge1} | - | 1.22 | 5 | mA | V _{VCC} = 0 V |
| | I _{VCCcharge2} | 0.8 | 1.1 | - | mA | V _{VCC} = 1 V |
| | I _{VCCcharge3} | - | 1 | - | mA | V _{VCC} = V _{VCCcon} - 0.2 V |
| Maximum Input Current of Startup Cell and CoolMOS™ | I _{DrainIn} | - | - | 2 | mA | V _{VCC} = V _{VCCcon} - 0.2 V |
| Leakage Current of Startup Cell and CoolMOS™ | I _{DrainLeak} | - | 0.2 | 50 | μ A | V _{Drain} = 650 V at T _J = 100 °C |
| Supply Current in normal operation | I _{VCCNM} | - | 1.5 | 2.3 | mA | output low |
| Supply Current in Auto Restart Mode with Inactive Gate | I _{VCCAR} | - | 300 | - | μ A | I _{FB} = 0 A |
| Supply Current in Latch-off Mode | I _{VCClatch} | - | 300 | - | μ A | |
| Supply Current in Burst Mode with inactive Gate | I _{VCCburst} | - | 500 | 950 | μ A | V _{FB} = 2.5 V, exclude the current flowing out from FB pin |
| VCC Turn-On Threshold | V _{VCCon} | 17.0 | 18.0 | 19.0 | V | |
| VCC Turn-Off Threshold | V _{VCCoff} | 9.8 | 10.5 | 11.2 | V | |
| VCC Turn-On/Off Hysteresis | V _{VCChys} | - | 7.5 | - | V | |

Electrical Characteristics

4.3.2 Internal Voltage Reference

Table 7 Internal Voltage Reference

| Parameter | Symbol | Limit Values | | | Unit | Test Condition |
|---------------------------|------------------|--------------|------|------|------|---|
| | | min. | typ. | max. | | |
| Trimmed Reference Voltage | V _{REF} | 4.80 | 5.00 | 5.20 | V | measured at pin FB I _{FB} = 0 |

4.3.3 PWM Section

Table 8 PWM Section

| Parameter | Symbol | Limit Values | | | Unit | Test Condition |
|-------------------------------------|--------------------|--------------|------|------|------|---------------------------|
| | | min. | typ. | max. | | |
| Feedback Pull-Up Resistor | R _{FB} | 14 | 23 | 33 | kΩ | Feedback Pull-Up Resistor |
| PWM-OP Gain | G _{PWM} | 3.18 | 3.3 | - | - | PWM-OP Gain |
| Offset for Voltage Ramp | V _{PWM} | 0.6 | 0.7 | - | V | Offset for Voltage Ramp |
| Maximum on time in normal operation | t _{OnMax} | 22 | 30 | 41 | μs | Maximum on time in normal |

4.3.4 Current Sense

Table 9 Current sense

| Parameter | Symbol | Limit Values | | | Unit | Test Condition |
|---|-------------------|--------------|------|------|------|----------------|
| | | min. | typ. | max. | | |
| Peak current limitation in normal operation | V _{CStH} | 0.97 | 1.03 | 1.09 | V | |
| Leading Edge Blanking time | t _{LEB} | 200 | 330 | 460 | ns | |
| Peak Current Limitation in Active Burst | V _{CSB} | 0.29 | 0.34 | 0.39 | V | |

4.3.5 Soft Start

Table 10 Soft Start

| Parameter | Symbol | Limit Values | | | Unit | Test Condition |
|--|--------------------------------|--------------|------|------|------|----------------|
| | | min. | typ. | max. | | |
| Soft-Start time | t _{SS} | 8.5 | 12 | - | ms | |
| Soft-start time step | | - | 3 | - | ms | |
| Internal regulation voltage at first step | V _{SS1} ¹ | - | 1.76 | - | V | |
| Internal regulation voltage step at soft start | V _{SS_S} ¹ | - | 0.56 | - | V | |

¹ The parameter is not subjected to production test - verified by design/characterization

Electrical Characteristics

4.3.6 Foldback Point Correction

Table 11 Foldback Point Correction

| Parameter | Symbol | Limit Values | | | Unit | Test Condition |
|---------------------------------|--------------|--------------|------|-------|------|---|
| | | min. | typ. | max. | | |
| ZC current first step threshold | I_{ZC_FS} | 0.350 | 0.5 | 0.621 | mA | |
| ZC current last step threshold | I_{ZC_LS} | 1.3 | 1.7 | 2.2 | mA | |
| CS threshold minimum | V_{CSMF} | - | 0.66 | - | V | $I_{ZC}=2.2\text{ mA}, V_{FB}=3.8\text{ V}$ |

4.3.7 Digital Zero Crossing

Table 12 Digital Zero Crossing

| Parameter | Symbol | Limit Values | | | Unit | Test Condition |
|---|--------------|--------------|------|------|---------------|---------------------|
| | | min. | typ. | max. | | |
| Zero crossing threshold voltage | V_{ZCCT} | 50 | 100 | 170 | mV | |
| Ringing suppression threshold | V_{ZCRS} | - | 0.7 | - | V | |
| Minimum ringing suppression time | t_{ZCRS1} | 1.62 | 2.5 | 4.5 | μs | $V_{ZC} > V_{ZCRS}$ |
| Maximum ringing suppression time | t_{ZCRS2} | - | 25 | - | μs | $V_{ZC} < V_{ZCRS}$ |
| Threshold to set Up/Down Counter to one | V_{FBRI} | - | 3.9 | - | V | |
| Threshold for downward counting at low line | V_{FBZHL} | - | 3.2 | - | V | |
| Threshold for upward counting at low line | V_{FBZLL} | - | 2.5 | - | V | |
| Threshold for downward counting at high line | V_{FBZHH} | - | 2.9 | - | V | |
| Threshold for upward counting at highline | V_{FBZLH} | - | 2.3 | - | V | |
| ZC current for IC switch threshold to high line | I_{ZCSH} | - | 1.3 | - | mA | |
| ZC current for IC switch threshold to low line | I_{ZCSL} | - | 0.8 | - | mA | |
| Counter time ¹ | t_{COUNT} | - | 48 | - | ms | |
| Maximum restart time in normal | t_{OffMax} | 30 | 42 | 57.5 | μs | |

¹ The parameter is not subjected to production test - verified by design/characterization

Electrical Characteristics

4.3.8 Active Burst Mode

Table 13 Digital Zero Crossing

| Parameter | Symbol | Limit Values | | | Unit | Test Condition |
|--|---------------|--------------|------|------|------|----------------|
| | | min. | typ. | max. | | |
| Feedback voltage for entering Active | V_{FBEB} | - | 1.25 | - | V | |
| Minimum Up/down value for entering Active Burst Mode | N_{ZC_ABM} | - | 7 | - | | |
| Blanking time for entering Active Burst Mode | t_{BEB} | - | 24 | - | ms | |
| Feedback voltage for leaving Active Burst Mode | V_{FBLB} | - | 4.5 | - | V | |
| Feedback voltage for burst-on | V_{FBBOon} | - | 3.6 | - | V | |
| Feedback voltage for burst-off | V_{FBBOff} | - | 3.0 | - | V | |
| Fixed Switching Frequency in Active Burst Mode | f_{SB} | 39 | 52 | 65 | kHz | |
| Max. Duty Cycle in Active Burst Mode | D_{maxB} | | | | | |

4.3.9 Protection

Table 14 Protection

| Parameter | Symbol | Limit Values | | | Unit | Test Condition |
|---|--------------|--------------|------|------|------|----------------|
| | | min. | typ. | max. | | |
| VCC overvoltage threshold | V_{VCCOVP} | 24.0 | 25.0 | 26.0 | V | |
| Over Load or Open Loop Detection threshold for OLP protection at FB pin | V_{FBOLP} | - | 4.5 | - | V | |
| Over Load or Open Loop Protection Blanking Time | t_{OLP_B} | 20 | 30 | 44 | ms | |
| Output Overvoltage detection threshold at the ZC pin | V_{ZCOVP} | 3.55 | 3.7 | 3.84 | V | |
| Blanking time for Output Overvoltage | t_{ZCOVP} | - | 100 | - | μs | |
| Threshold for short winding | V_{CSSW} | 1.63 | 1.68 | 1.78 | V | |
| Blanking time for short-winding protection | t_{CSSW} | - | 190 | - | ns | |
| Over temperature protection ¹ | T_{jCon} | 130 | 140 | 150 | °C | |

Note: The trend of all the voltage levels in the Control Unit is the same regarding the deviation except V_{VCCOVP}

¹ The parameter is not subjected to production test - verified by design/characterization

Electrical Characteristics

4.3.10 CoolMOS™ Section

Table 15 CoolMOS™ Section

| Parameter | Symbol | Limit Values | | | Unit | Test Condition |
|--|---------------|--------------|------------------------|-----------------------|----------|---|
| | | min. | typ. | max. | | |
| Drain Source Breakdown Voltage | $V_{(BR)DSS}$ | 800 870 | - | - | V | $T_j = 25\text{ °C}$ $T_j = 110\text{ °C}$ |
| Drain Source On-Resistance | R_{DSon} | - | 4.70 10.45 12.76 | 5.18 11.5 14.04 | Ω | $T_j = 25\text{ °C}$ $T_j = 125\text{ °C}^1$ $T_j = 150\text{ °C}^1$ at $I_D = 0.58\text{ A}$ |
| Effective output capacitance, energy related | $C_{o(er)}$ | - | 5.8^1 | - | pF | $V_{DS} = 0\text{ V to }480\text{ V}$ |
| Rise Time | t_{rise} | - | 30^2 | - | ns | |
| Fall Time | t_{fall} | - | 30^2 | - | ns | |

¹ The parameter is not subjected to production test - verified by design/characterization

² Measured in a Typical Flyback Converter Application

CoolMOS™ Performance Characteristics

5 CoolMOS™ Performance Characteristics

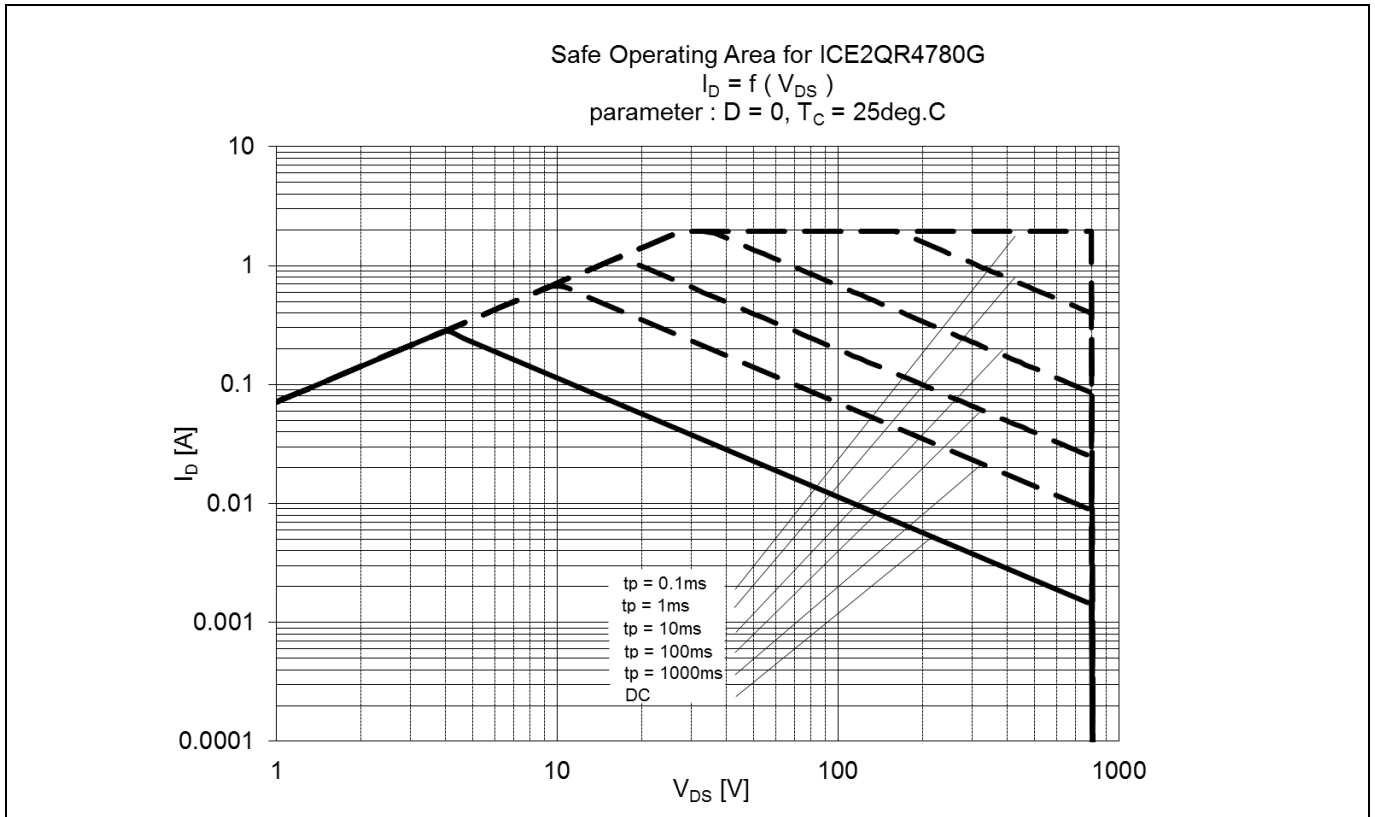

Figure 10 Safe Operating Area (SOA) curve for ICE2QR4780G

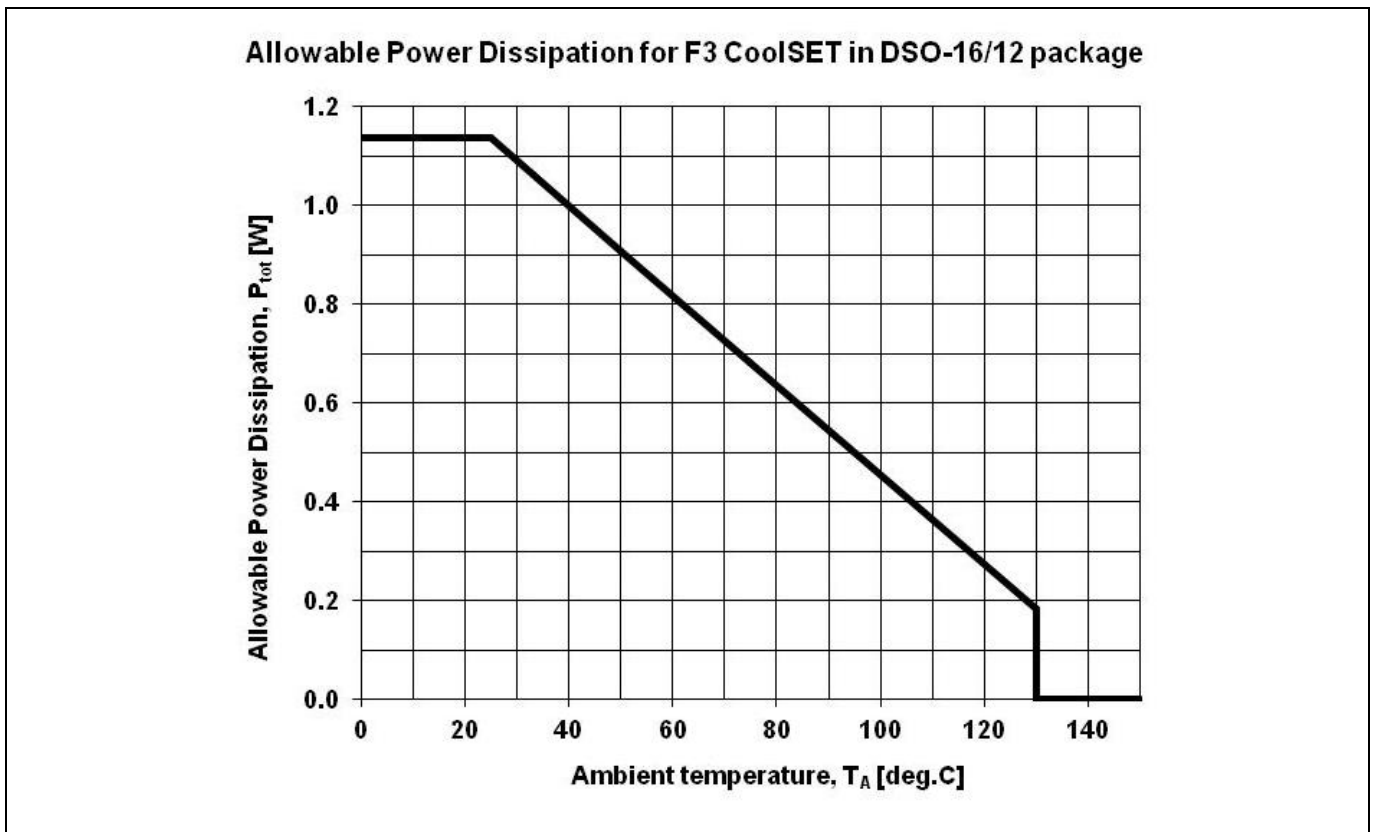

Figure 11 Power dissipation; $P_{tot}=f(T_A)$

CoolMOS™ Performance Characteristics

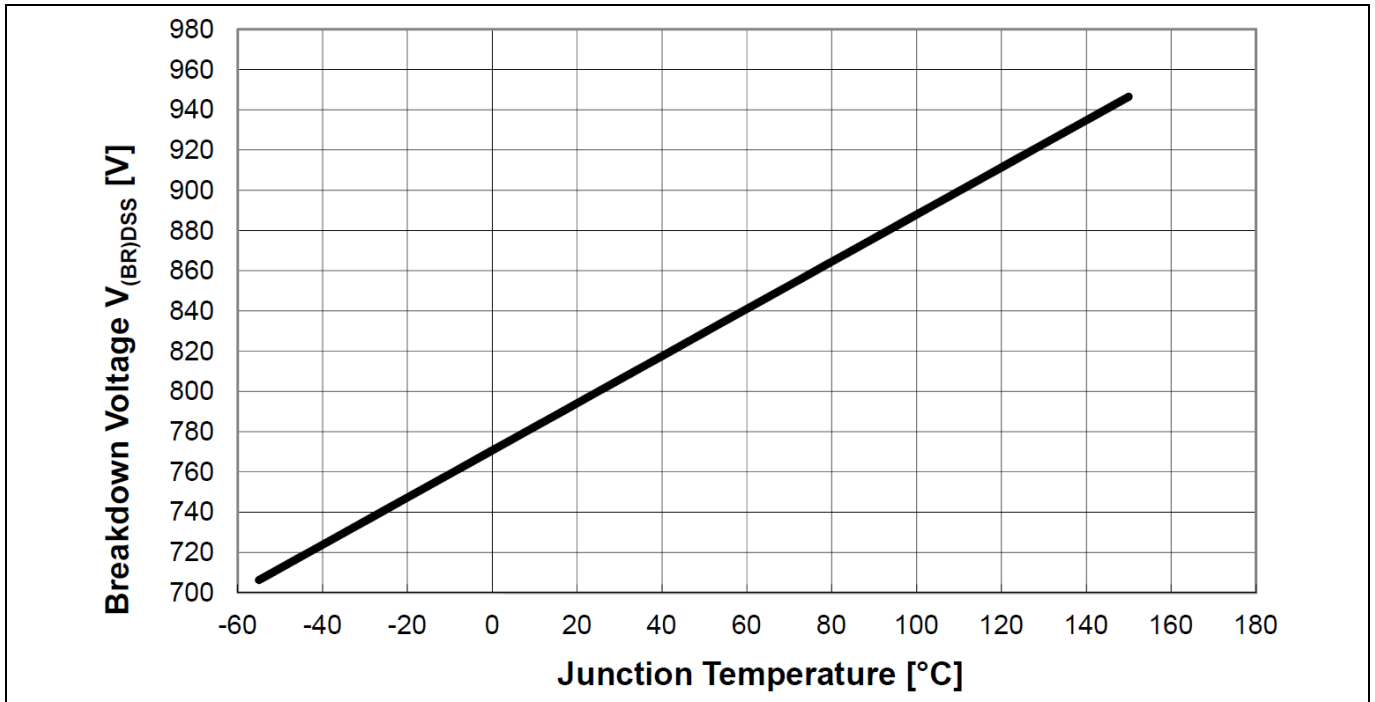

Figure 12 Drain-source breakdown voltage; $V_{BR(DSS)}=f(T_j)$, $I_D=0.25mA$

Input Power Curve

6 Input Power Curve

Two input power curves giving the typical input power versus ambient temperature are showed below; $V_{IN}=85 V_{AC} \sim 265 V_{AC}$ (Figure 13) and $V_{IN}=230 V_{AC} \pm 15\%$ (Figure 14). The curves are derived based on a typical discontinuous mode flyback model which considers either 50% maximum duty ratio or 100 V maximum secondary to primary reflected voltage (higher priority). The calculation is based on 232 mm² copper area as heatsink for the device. The input power already includes the power loss at input common mode choke, bridge rectifier and the CoolMOS™. The device saturation current ($I_{D_Puls} @ T_j=125^\circ C$) is also considered.

To estimate the output power of the device, it is simply multiplying the input power at a particular operating ambient temperature with the estimated efficiency for the application. For example, a wide range input voltage (Figure 13), operating temperature is 50°C, estimated efficiency is 85%, then the estimated output power is 18.7 W (22 W * 85%).

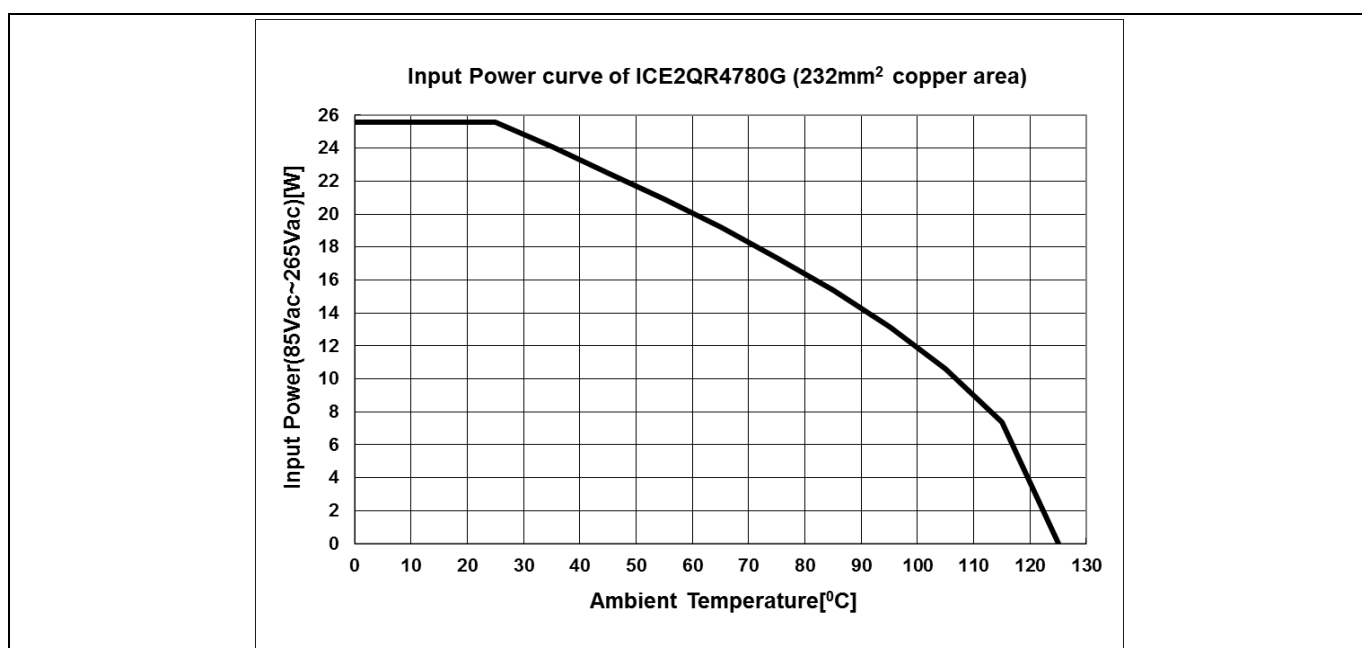

Figure 13 Input power curve $V_{IN}=85 \sim 265 V_{AC}$; $P_{in}=f(T_a)$

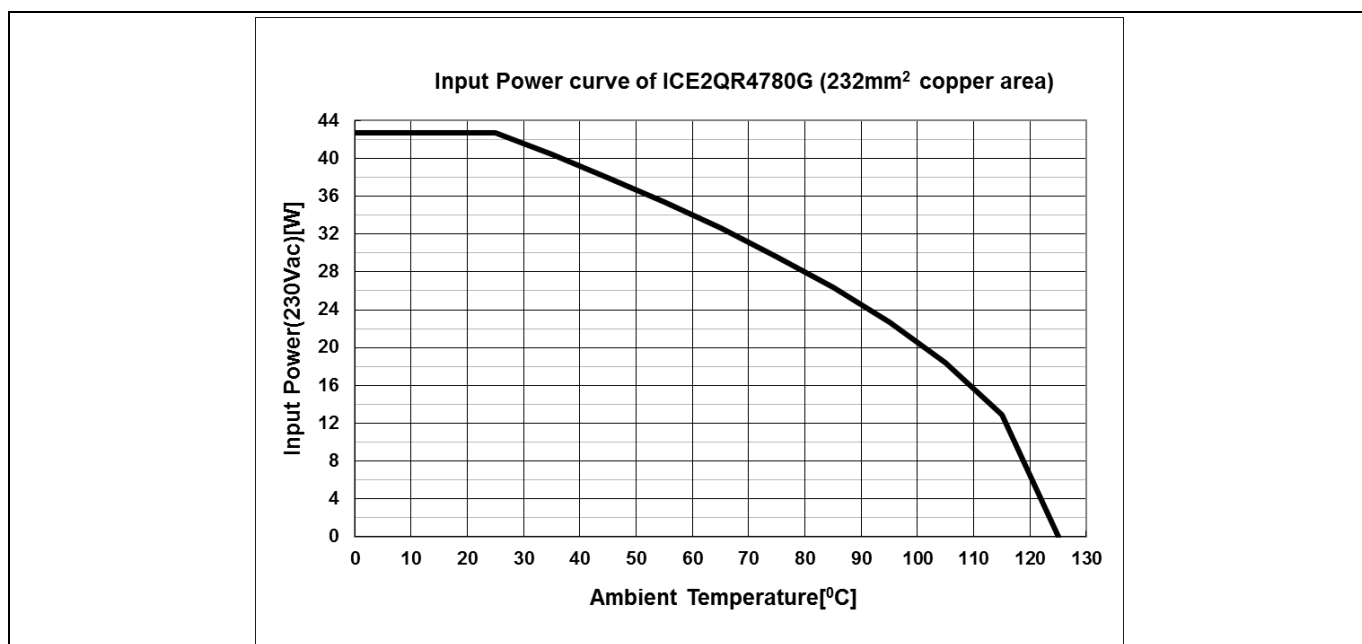

Figure 14 Input power curve $V_{IN}=230 V_{AC}$; $P_{in}=f(T_a)$

Outline Dimension

7 Outline Dimension



Figure 15 PG-DSO-12 (Pb-free lead plating Plastic Dual-in-Line Outline)

Marking

8 Marking

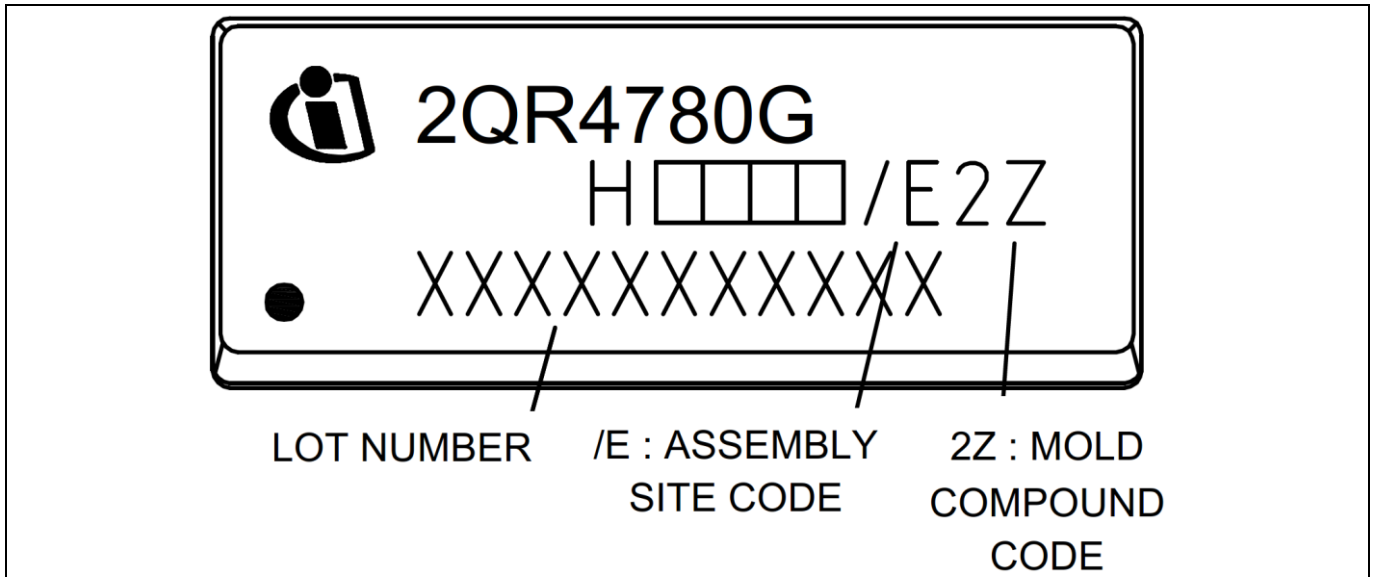

Figure 16 Marking for ICE2QR4780G

Revision History

Major changes since the last revision

| Page or Reference | Description of change |
|-------------------|-----------------------|
| 1, 23 | change marking |
| | |
| | |

Trademarks of Infineon Technologies AG

AURIX™, C166™, CanPAK™, CIPOST™, CoolGaN™, CoolMOS™, CoolSET™, CoolSiC™, CORECONTROL™, CROSSAVE™, DAVE™, DI-POL™, DrBlade™, EasyPIM™, EconoBRIDGE™, EconoDUAL™, EconoPACK™, EconoPIM™, EiceDRIVER™, eupec™, FCOS™, HITFET™, HybridPACK™, Infineon™, ISOFACE™, IsoPACK™, i-Wafer™, MIPAQ™, ModSTACK™, my-d™, NovalithIC™, OmniTune™, OPTIGA™, OptiMOS™, ORIGA™, POWERCODE™, PRIMARION™, PrimePACK™, PrimeSTACK™, PROFET™, PRO-SIL™, RASIC™, REAL3™, ReverSave™, SatRIC™, SIEGET™, SIPMOS™, SmartLEWIS™, SOLID FLASH™, SPOC™, TEMPFET™, thinQ!™, TRENCHSTOP™, TriCore™.

Trademarks updated August 2015

Other Trademarks

All referenced product or service names and trademarks are the property of their respective owners.

Edition 2017-06-13

Published by

Infineon Technologies AG

81726 München, Germany

© 2017 Infineon Technologies AG.

All Rights Reserved.

Do you have a question about this document?

Email: erratum@infineon.com

Document reference

IMPORTANT NOTICE

The information given in this document shall in no event be regarded as a guarantee of conditions or characteristics ("Beschaffenheitsgarantie").

With respect to any examples, hints or any typical values stated herein and/or any information regarding the application of the product, Infineon Technologies hereby disclaims any and all warranties and liabilities of any kind, including without limitation warranties of non-infringement of intellectual property rights of any third party.

In addition, any information given in this document is subject to customer's compliance with its obligations stated in this document and any applicable legal requirements, norms and standards concerning customer's products and any use of the product of Infineon Technologies in customer's applications.

The data contained in this document is exclusively intended for technically trained staff. It is the responsibility of customer's technical departments to evaluate the suitability of the product for the intended application and the completeness of the product information given in this document with respect to such application.

For further information on the product, technology, delivery terms and conditions and prices please contact your nearest Infineon Technologies office (www.infineon.com).

WARNINGS

Due to technical requirements products may contain dangerous substances. For information on the types in question please contact your nearest Infineon Technologies office.

Except as otherwise explicitly approved by Infineon Technologies in a written document signed by authorized representatives of Infineon Technologies, Infineon Technologies' products may not be used in any applications where a failure of the product or any consequences of the use thereof can reasonably be expected to result in personal injury.

X-ON Electronics

Largest Supplier of Electrical and Electronic Components

Click to view similar products for [AC/DC Converters](#) category:

Click to view products by [Infineon](#) manufacturer:

Other Similar products are found below :

[FSFR2100US](#) [BP5722A12](#) [ICE3AR0680VJZ](#) [ICE3AR2280CJZ](#) [ICE3BR0680JZ](#) [ICE3BR2280JZ](#) [SEA01](#) [FAN7621SSJX](#) [BP5055-12](#)
[BP5718A12](#) [ICE2QR4780Z](#) [NCP1124BP100G](#) [AP3983EP7-G1](#) [ICE3AR10080CJZ](#) [SC1076P065G](#) [47132](#) [47220](#) [47225](#) [APR3415BMTR-](#)
[G1](#) [NCP1126BP100G](#) [HF500GP-40](#) [TNY179PN](#) [ICE3AR10080JZXKLA1](#) [BM2P0361-Z](#) [BM2P249Q-Z](#) [BM521Q25F-GE2](#) [INN3164C-](#)
[H107-TL](#) [HR1001CGS-P](#) [HR1001LGS-P](#) [BM2P131X-Z](#) [BM2P161X-Z](#) [BM2P181X-Z](#) [BM2P201X-Z](#) [BM2P241X-Z](#) [LNK576DG-TL](#)
[INN3278C-H215-TL](#) [INN3278C-H217-TL](#) [INN3678C-H605-TL](#) [TNY263PN](#) [TNY286PG](#) [TNY287PG](#) [TNY288DG-TL](#) [TNY288PG](#)
[BP5034D24](#) [ICE2QR2280Z1XKLA1](#) [ICE2QS02GXUMA1](#) [ICE3A1065ELJFKLA1](#) [ICE3AR2280JZXKLA1](#) [ICE3B1565JFKLA1](#) [INN2003K](#)