

### 3<sup>rd</sup> Generation thinQ!<sup>TM</sup> SiC Schottky Diode

#### Features

- Revolutionary semiconductor material - Silicon Carbide
- Switching behavior benchmark
- No reverse recovery / No forward recovery
- Temperature independent switching behavior
- High surge current capability
- Pb-free lead plating; RoHS compliant
- Qualified according to JEDEC<sup>1)</sup> for target applications
- Breakdown voltage tested at 20mA<sup>2)</sup>
- Optimized for high temperature operation
- Lowest Figure of Merit  $Q_C/I_F$

#### Product Summary

$V_{DC}$	600	V
$Q_C$	19	nC
$I_F; T_C < 130\text{ °C}$	12	A

#### PG-TO220-2

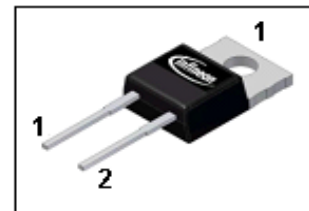

#### thinQ! 3G Diode designed for fast switching applications like:

- SMPS e.g.; CCM PFC
- Motor Drives; Solar Applications; UPS



Type	Package	Marking	Pin 1	Pin 2
IDH12SG60C	PG-TO220-2	D12G60C	C	A

#### Maximum ratings

Parameter	Symbol	Conditions	Value	Unit
Continuous forward current	$I_F$	$T_C < 130\text{ °C}$	12	A
Surge non-repetitive forward current, sine halfwave	$I_{F,SM}$	$T_C = 25\text{ °C}, t_p = 10\text{ ms}$	59	
		$T_C = 150\text{ °C}, t_p = 10\text{ ms}$	51	
Non-repetitive peak forward current	$I_{F,max}$	$T_C = 25\text{ °C}, t_p = 10\text{ }\mu\text{s}$	430	
$i^2t$ value	$\int i^2 dt$	$T_C = 25\text{ °C}, t_p = 10\text{ ms}$	17	A <sup>2</sup> s
		$T_C = 150\text{ °C}, t_p = 10\text{ ms}$	12	
Repetitive peak reverse voltage	$V_{RRM}$	$T_j = 25\text{ °C}$	600	V
Diode dv/dt ruggedness	dv/dt	$V_R = 0 \dots 480\text{ V}$	50	V/ns
Power dissipation	$P_{tot}$	$T_C = 25\text{ °C}$	125	W
Operating and storage temperature	$T_j, T_{stg}$		-55 ... 175	°C
Soldering temperature, wavesoldering only allowed at leads	$T_{sold}$	1.6mm (0.063 in.) from case for 10s	260	
Mounting torque		M3 and M3.5 screws	60	Ncm

Parameter	Symbol	Conditions	Values			Unit
			min.	typ.	max.	

**Thermal characteristics**

Thermal resistance, junction - case	$R_{thJC}$		-	-	1.2	K/W
Thermal resistance, junction - ambient	$R_{thJA}$	Thermal resistance, junction- ambient, leaded	-	-	62	

**Electrical characteristics, at  $T_j=25\text{ }^\circ\text{C}$ , unless otherwise specified**
**Static characteristics**

DC blocking voltage	$V_{DC}$	$I_R=0.05\text{ mA}$ , $T_j=25\text{ }^\circ\text{C}$	600	-	-	V
Diode forward voltage	$V_F$	$I_F=12\text{ A}$ , $T_j=25\text{ }^\circ\text{C}$	-	1.8	2.1	
		$I_F=12\text{ A}$ , $T_j=150\text{ }^\circ\text{C}$	-	2.2	-	
Reverse current	$I_R$	$V_R=600\text{ V}$ , $T_j=25\text{ }^\circ\text{C}$	-	1	100	$\mu\text{A}$
		$V_R=600\text{ V}$ , $T_j=150\text{ }^\circ\text{C}$	-	4	1000	

**AC characteristics**

Total capacitive charge	$Q_C$	$V_R=400\text{ V}$ , $I_F \leq I_{F,max}$ , $di_F/dt=200\text{ A}/\mu\text{s}$ , $T_j=150\text{ }^\circ\text{C}$	-	19	-	nC
Switching time <sup>3)</sup>	$t_c$		-	-	<10	ns
Total capacitance	C	$V_R=1\text{ V}$ , $f=1\text{ MHz}$	-	310	-	$\mu\text{F}$
		$V_R=300\text{ V}$ , $f=1\text{ MHz}$	-	50	-	
		$V_R=600\text{ V}$ , $f=1\text{ MHz}$	-	50	-	

<sup>1)</sup> J-STD20 and JESD22

<sup>2)</sup> All devices tested under avalanche conditions, for a time periode of 10ms, at 20mA.

<sup>3)</sup>  $t_c$  is the time constant for the capacitive displacement current waveform (independent from  $T_j$ ,  $I_{LOAD}$  and  $di/dt$ ), different from  $t_{rr}$  which is dependent on  $T_j$ ,  $I_{LOAD}$  and  $di/dt$ . No reverse recovery time constant  $t_{rr}$  due to absence of minority carrier injection.

<sup>4)</sup> Under worst case  $Z_{th}$  conditions.

<sup>5)</sup> Only capacitive charge occuring, guaranteed by design.

**1 Power dissipation**

$P_{tot}=f(T_C)$ ; parameter:  $R_{thJC(max)}$

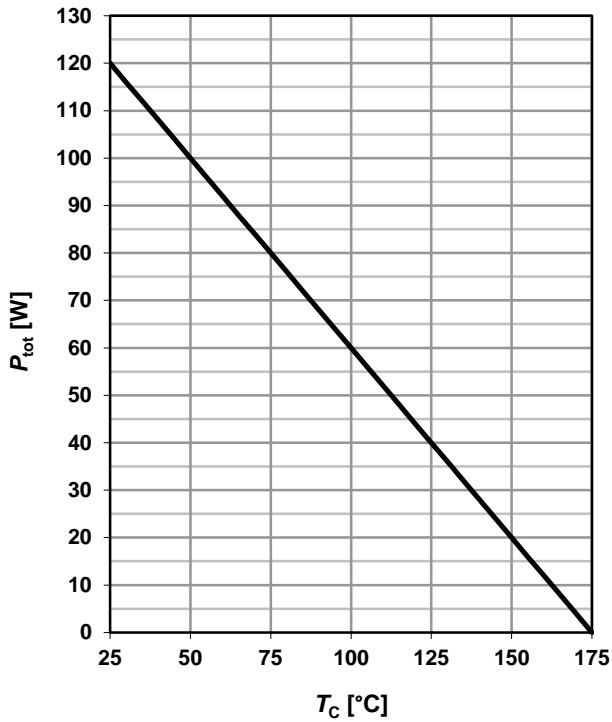

**2 Diode forward current**

$I_F=f(T_C)^4$ ;  $T_j \leq 175\text{ °C}$ ; parameter:  $D = t_p/T$

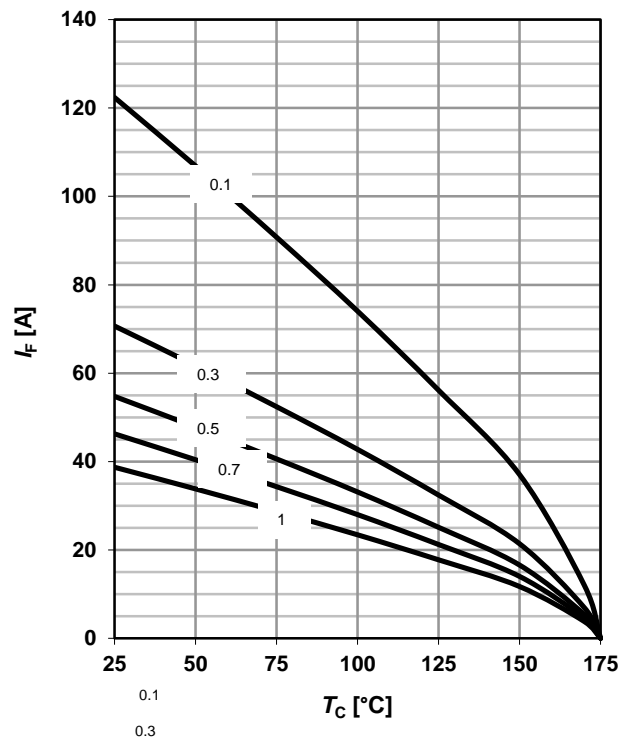

**3 Typ. forward characteristic**

$I_F=f(V_F)$ ;  $t_p=400\text{ }\mu\text{s}$ ; parameter:  $T_j$

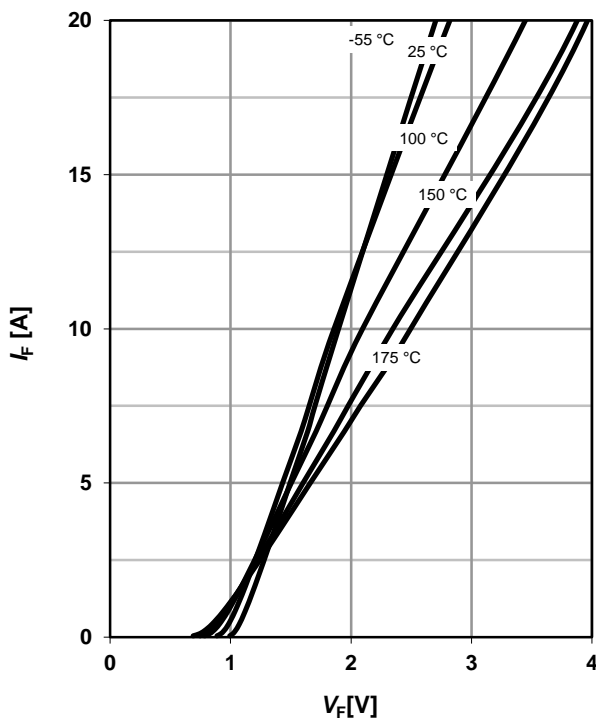

**4 Typ. forward characteristic in surge current mode**

$I_F=f(V_F)$ ;  $t_p=400\text{ }\mu\text{s}$ ; parameter:  $T_j$

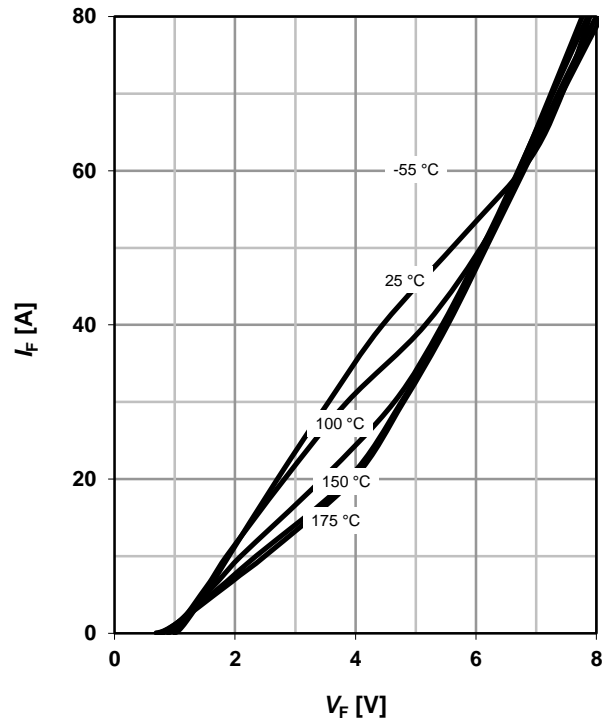

**5 Typ. capacitance charge vs. current slope**

$$Q_C = f(di_F/dt)^5; I_F \leq I_{F,max}$$

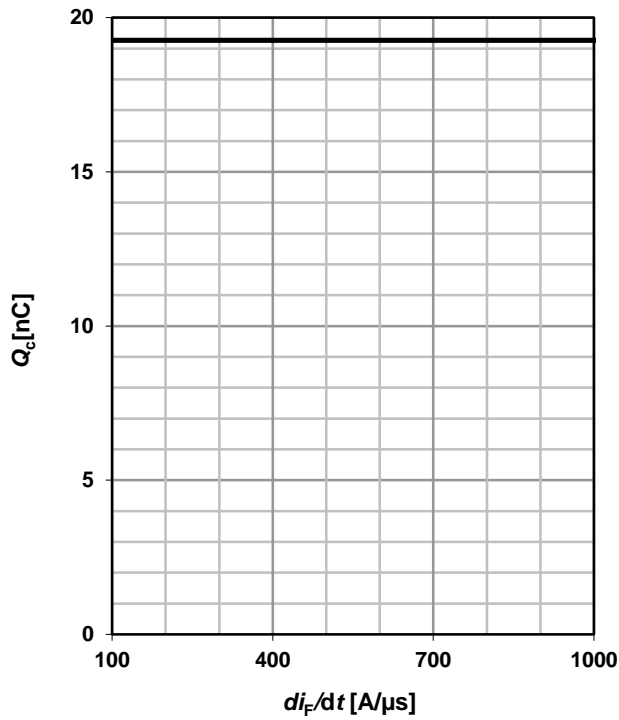

**6 Typ. reverse current vs. reverse voltage**

$$I_R = f(V_R); \text{parameter: } T_j$$

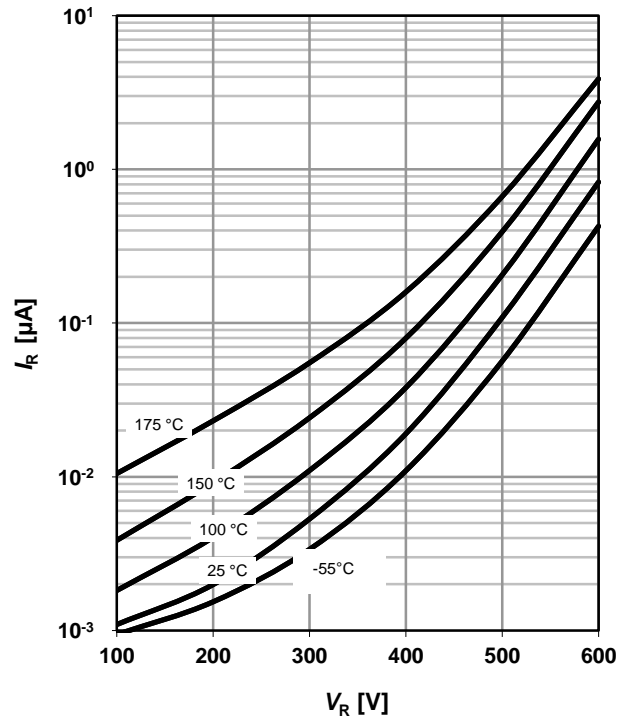

**7 Typ. transient thermal impedance**

$$Z_{thJC} = f(t_p); \text{parameter: } D = t_p/T$$

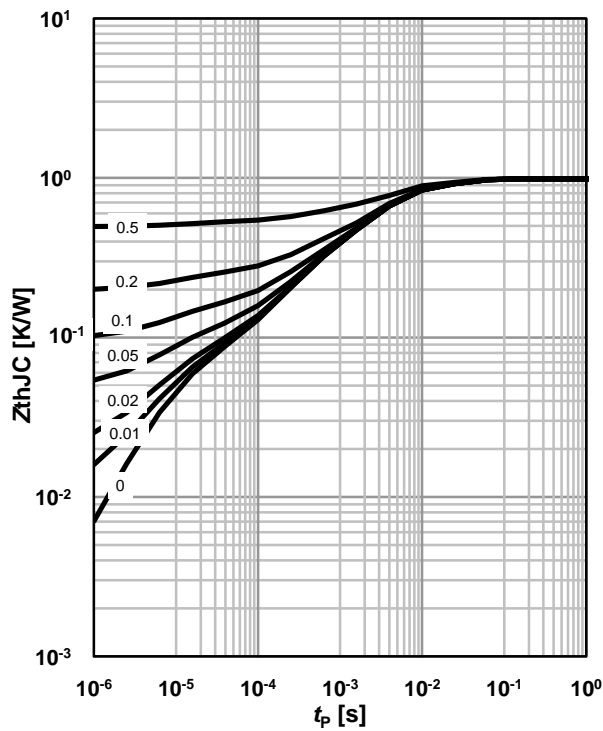

**8 Typ. capacitance vs. reverse voltage**

$$C = f(V_R); T_C = 25 \text{ °C}, f = 1 \text{ MHz}$$

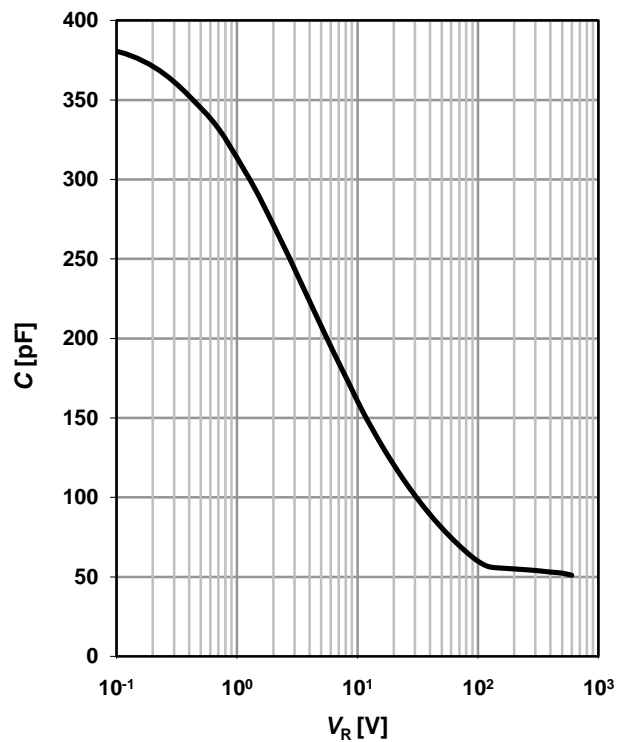

9 Typ. C stored energy

$$E_C=f(V_R)$$

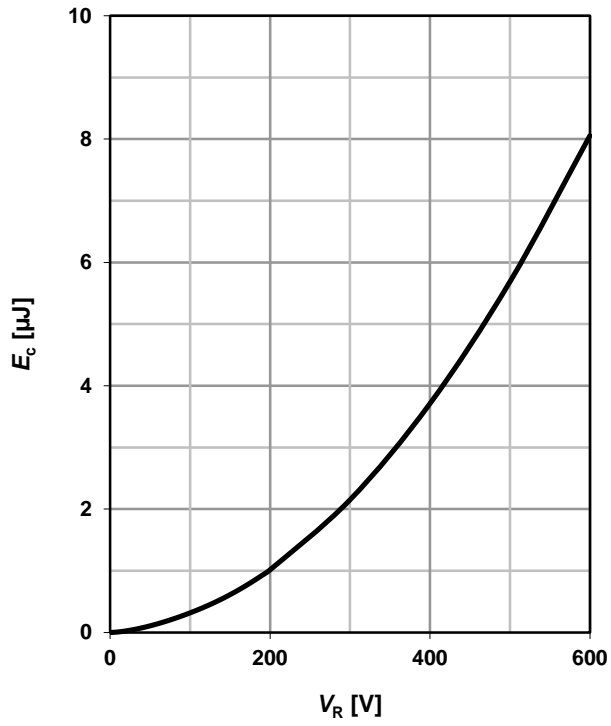

PG-T0220-2: Outline

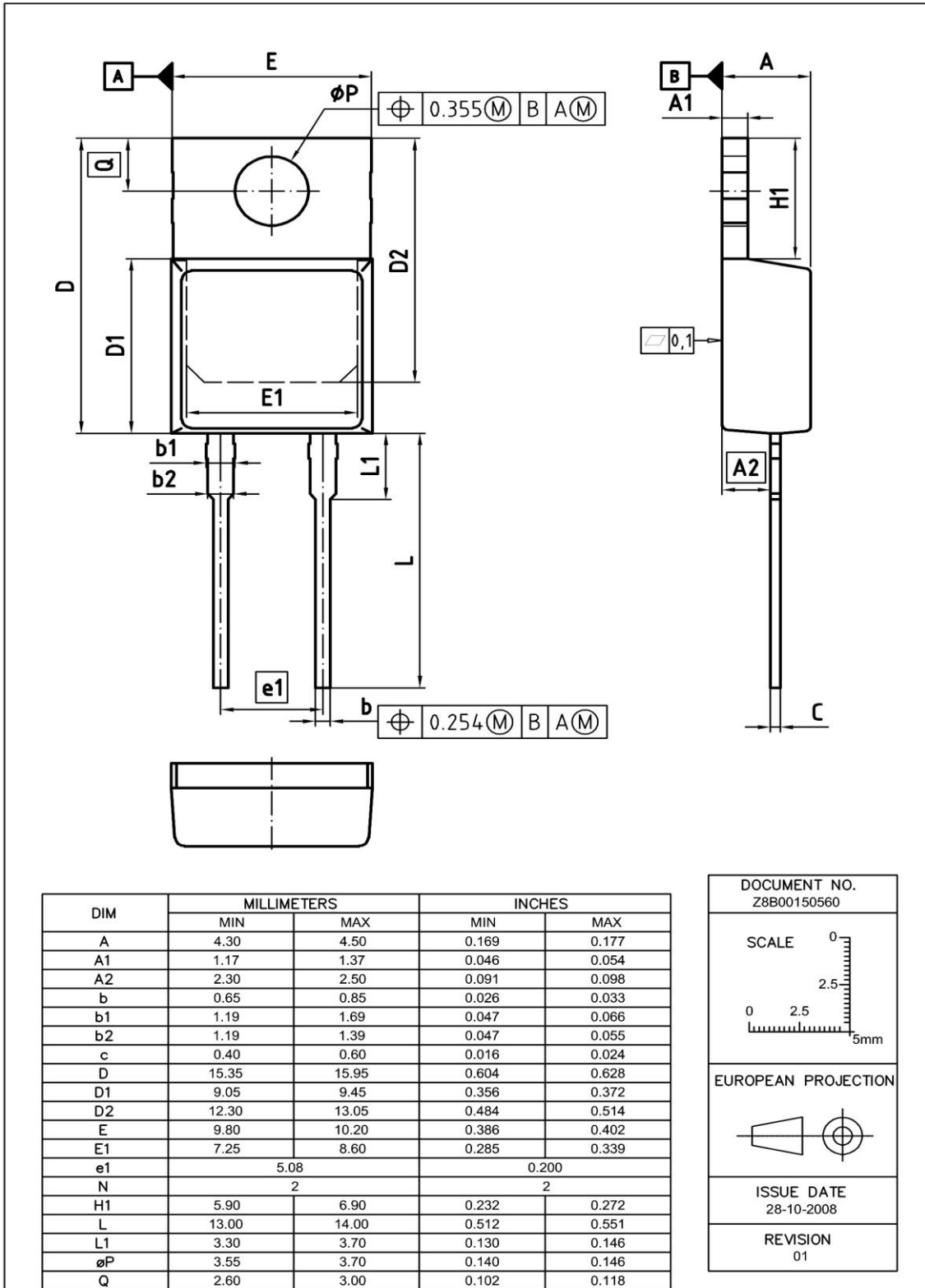

Dimensions in mm/inches

**Published by**  
**Infineon Technologies AG**  
**81726 Munich, Germany**  
**© 2012 Infineon Technologies AG**  
**All Rights Reserved.**

**Legal Disclaimer**

The information given in this document shall in no event be regarded as a guarantee of conditions or characteristics. With respect to any examples or hints given herein, any typical values stated herein and/or any information regarding the application of the device, Infineon Technologies hereby disclaims any and all warranties and liabilities of any kind, including without limitation, warranties of non-infringement of intellectual property rights of any third party.

**Information**

For further information on technology, delivery terms and conditions and prices, please [contact the nearest Infineon Technologies Office \(www.infineon.com\)](http://www.infineon.com).

**Warnings**

Due to technical requirements, components may contain dangerous substances. For information on the types in question, please contact the nearest Infineon Technologies Office. Infineon Technologies components may be used in life-support devices or systems and/or automotive, aviation and aerospace applications or systems only with the express written approval of Infineon Technologies, if a failure of such components can reasonably be expected to cause the failure of that life-support, automotive, aviation and aerospace device or system or to affect the safety or effectiveness of that device or system. Life support systems are intended to be implanted in the human body and/or maintain and sustain and/or protect human life. If they fail, it is reasonable to assume that the health of the user or other persons may be endangered.

## X-ON Electronics

Largest Supplier of Electrical and Electronic Components

*Click to view similar products for [Schottky Diodes & Rectifiers](#) category:*

*Click to view products by [Infineon](#) manufacturer:*

Other Similar products are found below :

[MA4E2039](#) [D1FH3-5063](#) [MBR0530L-TP](#) [MBR10100CT-BP](#) [MBR1545CT](#) [MMBD301M3T5G](#) [RB160M-50TR](#) [RB551V-30](#)  
[BAS16E6433HTMA1](#) [BAT 54-02LRH E6327](#) [NSR05F40QNXT5G](#) [NTE555](#) [JANS1N6640](#) [SB07-03C-TB-H](#) [SB1003M3-TL-W](#) [SK310-T](#)  
[SK32A-LTP](#) [SK34B-TP](#) [SS3003CH-TL-E](#) [GA01SHT18](#) [CRS10I30A\(TE85L,QM](#) [MA4E2501L-1290](#) [MBRB30H30CT-1G](#) [SB007-03C-TB-](#)  
[E](#) [SK32A-TP](#) [SK33B-TP](#) [SK38B-TP](#) [NRVBM120LT1G](#) [NTE505](#) [NTSB30U100CT-1G](#) [SS15E-TP](#) [VS-6CWQ10FNHM3](#) [ACDBA1100LR-](#)  
[HF](#) [ACDBA1200-HF](#) [ACDBA140-HF](#) [ACDBA2100-HF](#) [ACDBA3100-HF](#) [CDBQC0530L-HF](#) [CDBQC0240LR-HF](#) [ACDBA260LR-HF](#)  
[ACDBA1100-HF](#) [SK310B-TP](#) [MA4E2502L-1246](#) [MA4E2502H-1246](#) [NRVBM120ET1G](#) [NSR01L30MXT5G](#) [NTE573](#) [NTE6081](#) [SB560](#)  
[PMAD1108-LF](#)