

# Silicon Carbide Schottky Diode

## IDW10G120C5B

5<sup>th</sup> Generation CoolSiC™ 1200 V SiC Schottky Diode

**Final Datasheet**

Rev. 2.1 2017-07-21

**Industrial Power Control**

## CoolSiC™ SiC Schottky Diode

### Features:

- Revolutionary semiconductor material - Silicon Carbide
- No reverse recovery current / No forward recovery
- Temperature independent switching behavior
- Low forward voltage even at high operating temperature
- Tight forward voltage distribution
- Excellent thermal performance
- Extended surge current capability
- Specified dv/dt ruggedness
- Qualified according to JEDEC<sup>1)</sup> for target applications
- Pb-free lead plating; RoHS compliant

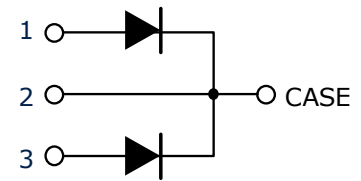

### Benefits

- System efficiency improvement over Si diodes
- Enabling higher frequency / increased power density solutions
- System size/cost savings due to reduced heatsink requirements and smaller magnetics
- Reduced EMI
- Highest efficiency across the entire load range
- Robust diode operation during surge events
- High reliability
- RelatedLinks: [www.infineon.com/sic](http://www.infineon.com/sic)



### Applications

- Solar inverters
- Uninterruptable power supplies
- Motor drives
- Power Factor Correction



### Package pin definitions

- Pin 1 – anode 1
- Pin 2 and backside – cathode
- Pin 3 – anode 2



### Key Performance and Package Parameters (leg/device)

Type	V <sub>DC</sub>	I <sub>F</sub>	Q <sub>C</sub>	T <sub>j,max</sub>	Marking	Package
IDW10G120C5B	1200 V	5 / 10 A	28 / 57 nC	175°C	D1012B5	PG-TO247-3

1) J-STD20 and JEDEC22

**Table of Contents**

Description .....	2
Table of Contents .....	3
Maximum Ratings .....	4
Thermal Resistances .....	4
Electrical Characteristics .....	5
Electrical Characteristics Diagram .....	5
Package Drawings .....	9
Revision History .....	10
Disclaimer .....	11

**Maximum ratings**

Parameter	Symbol	Value (leg/device)	Unit
Repetitive peak reverse voltage	$V_{RRM}$	1200	V
Continuous forward current for $R_{th(j-c,max)}$ $T_C = 156^\circ\text{C}$ , $D=1$ $T_C = 135^\circ\text{C}$ , $D=1$ $T_C = 25^\circ\text{C}$ , $D=1$	$I_F$	5 / 10 8 / 16 17 / 34	A
Surge non-repetitive forward current, sine halfwave $T_C=25^\circ\text{C}$ , $t_p=10\text{ms}$ $T_C=150^\circ\text{C}$ , $t_p=10\text{ms}$	$I_{F,SM}$	70 / 140 65 / 130	A
Non-repetitive peak forward current $T_C = 25^\circ\text{C}$ , $t_p=10 \mu\text{s}$	$I_{F,max}$	530 / 1070	A
$i^2t$ value $T_C = 25^\circ\text{C}$ , $t_p=10 \text{ms}$ $T_C = 150^\circ\text{C}$ , $t_p=10 \text{ms}$	$\int i^2 dt$	25 / 98 21 / 84	A <sup>2</sup> s
Diode $dv/dt$ ruggedness $V_R=0\dots960 \text{V}$	$dv/dt$	80	V/ns
Power dissipation for $R_{th(j-c,max)}$ $T_C = 25^\circ\text{C}$	$P_{tot}$	74 / 148	W
Operating and storage temperature	$T_j; T_{stg}$	-55...175	$^\circ\text{C}$
Soldering temperature, wavesoldering only allowed at leads 1.6mm (0.063 in.) from case for 10 s	$T_{sold}$	260	$^\circ\text{C}$
Mounting torque M3 and M4 screws	$M$	0.7	Nm

**Thermal Resistances**

Parameter	Symbol	Conditions	Value (leg/device)			Unit
			min.	typ.	max.	
<b>Characteristic</b>						
Diode thermal resistance, junction – case	$R_{th(j-c)}$		-	1.6/0.8	2.0/1.0	K/W
Thermal resistance, junction – ambient	$R_{th(j-a)}$	leaded	-	-	62	K/W

**Electrical Characteristics**
**Static Characteristic, at T<sub>j</sub>=25°C, unless otherwise specified**

Parameter	Symbol	Conditions	Value (leg/device)			Unit
			min.	typ.	max.	
DC blocking voltage	V <sub>DC</sub>	T <sub>j</sub> = 25°C	1200	-	-	V
Diode forward voltage	V <sub>F</sub>	I <sub>F</sub> = 5/10 A, T <sub>j</sub> = 25°C	-	1.4	1.65	V
		I <sub>F</sub> = 5/10 A, T <sub>j</sub> = 150°C	-	1.7	2.30	
Reverse current	I <sub>R</sub>	V <sub>R</sub> = 1200 V, T <sub>j</sub> = 25°C		3 / 6	40 / 80	μA
		V <sub>R</sub> = 1200 V, T <sub>j</sub> = 150°C		14 / 28	210 / 420	

**Dynamic Characteristics, at T<sub>j</sub>=25°C, unless otherwise specified**

Parameter	Symbol	Conditions	Value (leg/device)			Unit
			min.	typ.	max.	
Total capacitive charge	Q <sub>C</sub>	V <sub>R</sub> = 800 V, T <sub>j</sub> = 150°C & 25°C $Q_C = \int_0^{V_R} C(V) dV$	-	28 / 57	-	nC
Total Capacitance	C	V <sub>R</sub> = 1 V, f = 1 MHz	-	365 / 730	-	pF
		V <sub>R</sub> = 400 V, f = 1 MHz	-	26 / 51	-	
		V <sub>R</sub> = 800 V, f = 1 MHz	-	20 / 41	-	

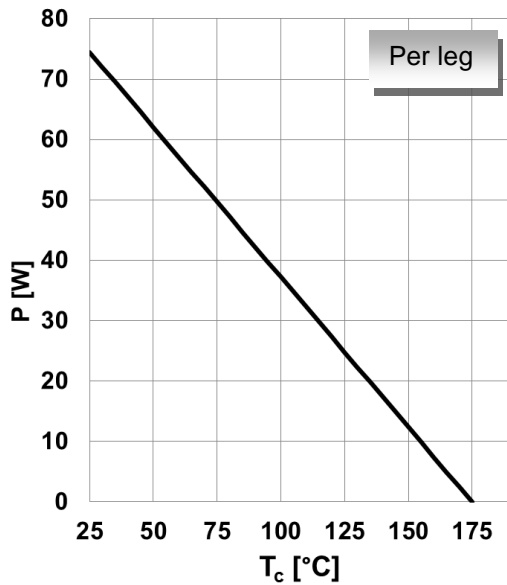

Figure 1. Power dissipation per leg as function of case temperature,  $P_{tot}=f(T_C)$ ,  $R_{th(j-c),max}$

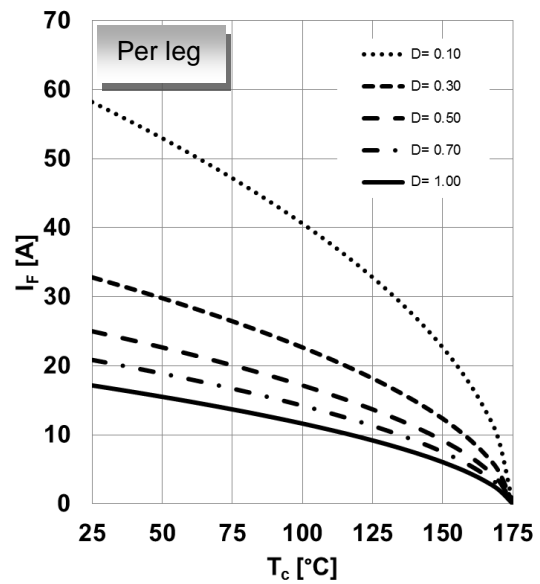

Figure 2. Diode forward current per leg as function of case temperature,  $I_F=f(T_C)$ ,  $T_j \leq 175^\circ\text{C}$ ,  $R_{th(j-c),max}$ , parameter  $D$ =duty cycle,  $V_{th}$ ,  $R_{diff}$  @  $T_j=175^\circ\text{C}$

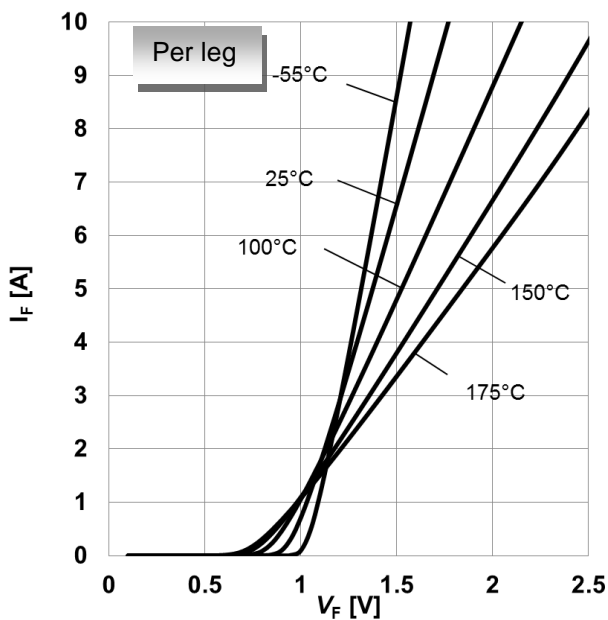

Figure 3. Typical forward characteristics per leg,  $I_F=f(V_F)$ ,  $t_p=10 \mu\text{s}$ , parameter:  $T_j$

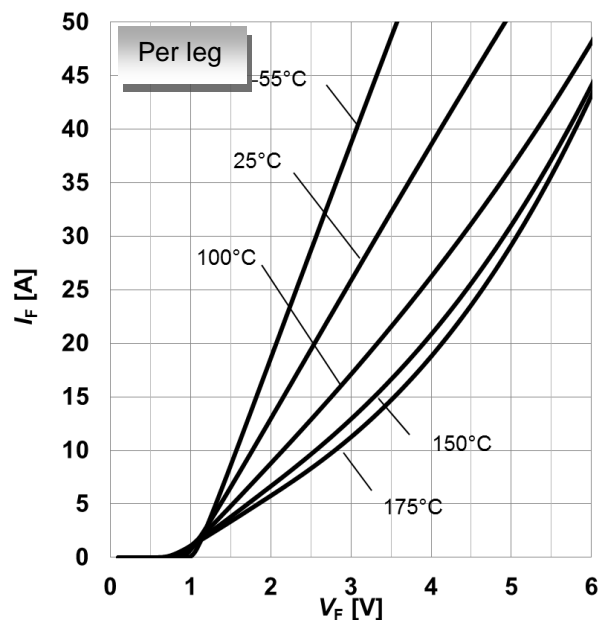

Figure 4. Typical forward characteristics in surge current per leg,  $I_F=f(V_F)$ ,  $t_p=10 \mu\text{s}$ , parameter:  $T_j$

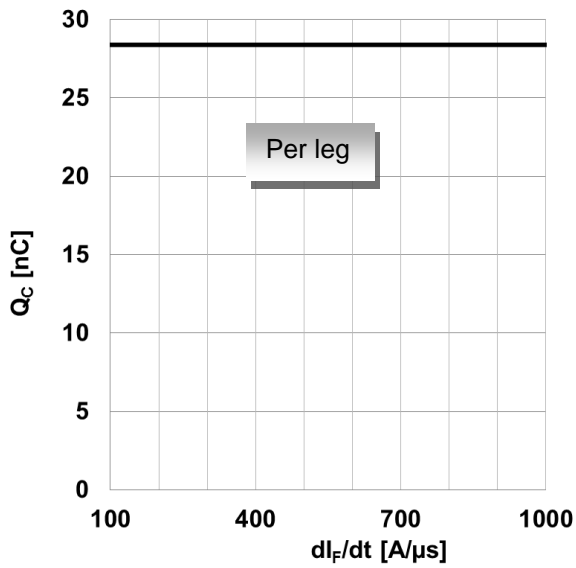

Figure 5. Typical capacitive charge per leg as function of current slope<sup>1</sup>,  $Q_c=f(di_F/dt)$ ,  $T_j=150^\circ\text{C}$   
 1) guaranteed by design.

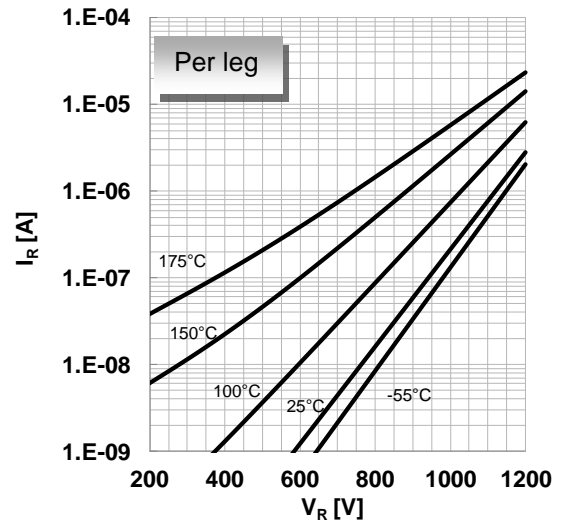

Figure 6. Typical reverse characteristics per leg,  $I_R=f(V_R)$ , parameter:  $T_j$

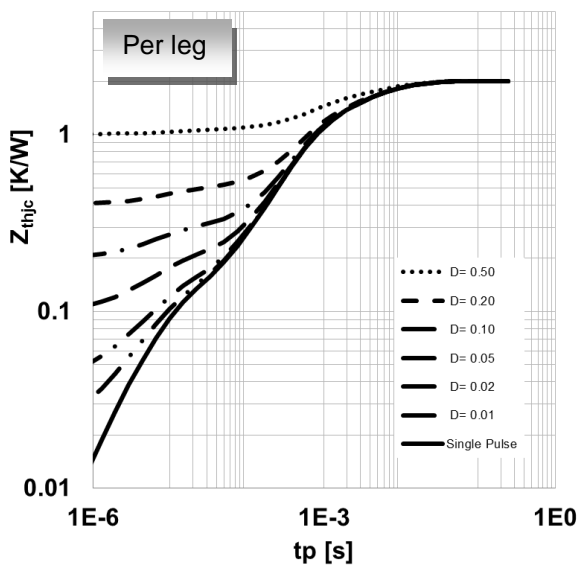

Figure 7. Max. transient thermal impedance per leg,  $Z_{th,jc}=f(t_p)$ , parameter:  $D=t_p/T$

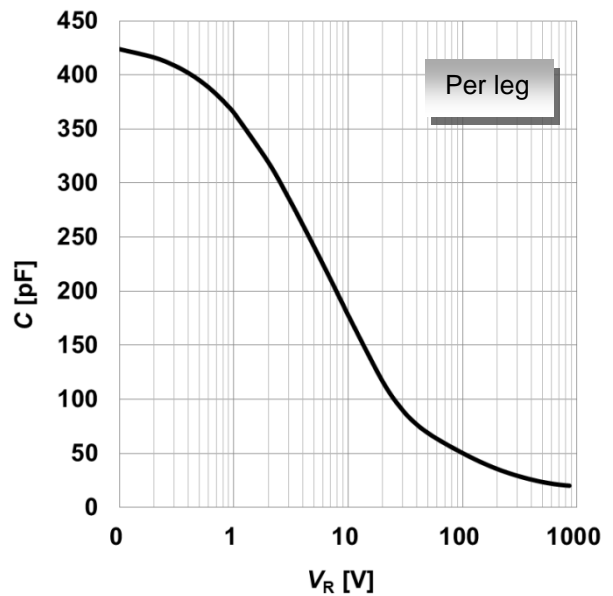

Figure 8. Typical capacitance per leg as function of reverse voltage,  $C=f(V_R)$ ;  $T_j=25^\circ\text{C}$ ;  $f=1\text{ MHz}$

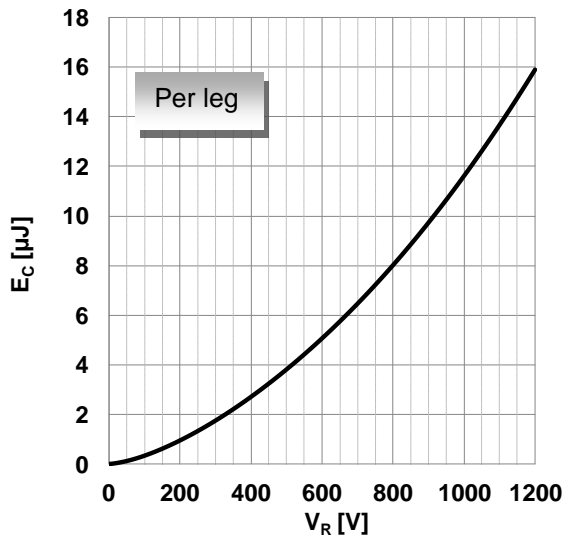
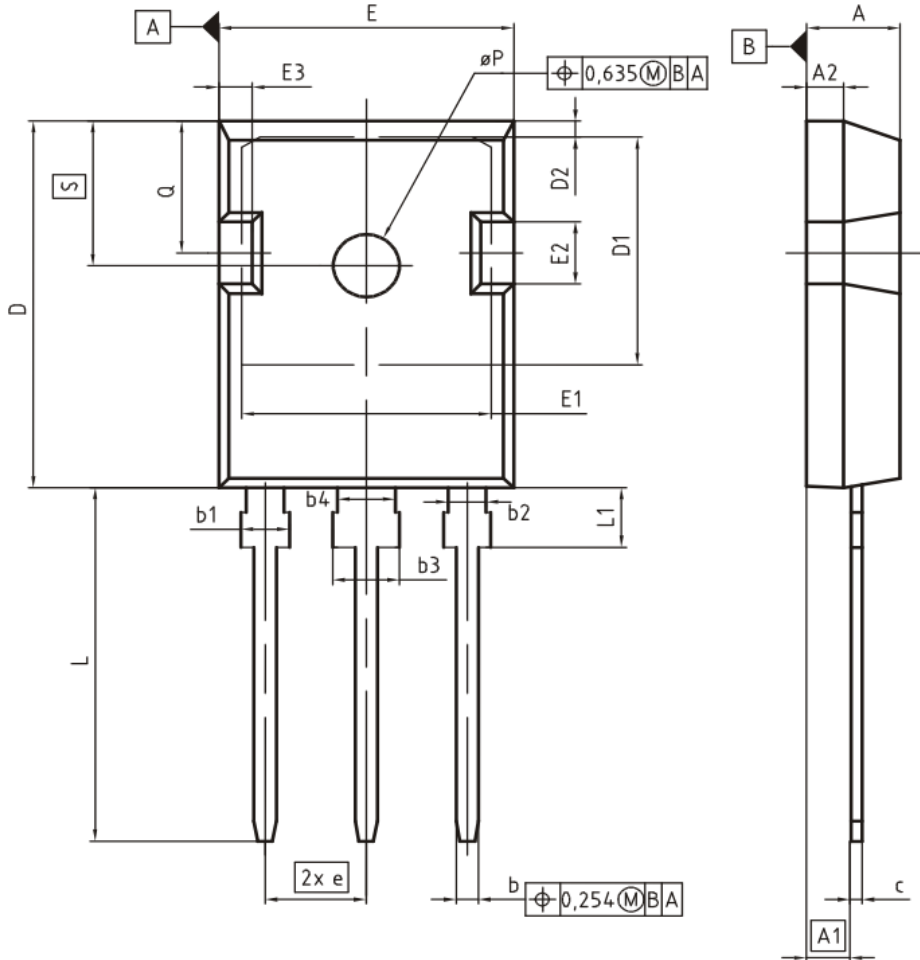

Figure 9. Typical capacitively stored energy as function of reverse voltage, per leg,  $E_C=f(V_R)$



PG-TO247-3



DIM	MILLIMETERS		INCHES	
	MIN	MAX	MIN	MAX
A	4.83	5.21	0.190	0.205
A1	2.27	2.54	0.089	0.100
A2	1.85	2.16	0.073	0.085
b	1.07	1.33	0.042	0.052
b1	1.90	2.41	0.075	0.095
b2	1.90	2.16	0.075	0.085
b3	2.87	3.38	0.113	0.133
b4	2.87	3.13	0.113	0.123
c	0.55	0.68	0.022	0.027
D	20.80	21.10	0.819	0.831
D1	16.25	17.65	0.640	0.695
D2	0.95	1.35	0.037	0.053
E	15.70	16.13	0.618	0.635
E1	13.10	14.15	0.516	0.557
E2	3.68	5.10	0.145	0.201
E3	1.00	2.60	0.039	0.102
e	5.44 (BSC)		0.214 (BSC)	
N	3		3	
L	19.80	20.32	0.780	0.800
L1	4.10	4.47	0.161	0.176
$\phi P$	3.50	3.70	0.138	0.146
Q	5.49	6.00	0.216	0.236
S	6.04	6.30	0.238	0.248

DOCUMENT NO.  
Z8B00003327

SCALE

EUROPEAN PROJECTION

ISSUE DATE  
09-07-2010

REVISION  
05

**Revision History**IDW10G120C5B

---

**Revision: 2017-07-21, Rev. 2.1**Previous Revision:

---

Revision	Date	Subjects (major changes since last version)
2.0	2014-06-10	Final data sheet
2.1	-	Editorial Changes

**We Listen to Your Comments**

Any information within this document that you feel is wrong, unclear or missing at all?

Your feedback will help us to continuously improve the quality of this document.

Please send your proposal (including a reference to this document) to: [erratum@infineon.com](mailto:erratum@infineon.com)

**Published by**  
**Infineon Technologies AG**  
**81726 München, Germany**  
**© Infineon Technologies AG 2017.**  
**All Rights Reserved.**

### **IMPORTANT NOTICE**

The information given in this document shall in no event be regarded as a guarantee of conditions or characteristics ("Beschaffenheitsgarantie"). With respect to any examples, hints or any typical values stated herein and/or any information regarding the application of the product, Infineon Technologies hereby disclaims any and all warranties and liabilities of any kind, including without limitation warranties of non-infringement of intellectual property rights of any third party.

In addition, any information given in this document is subject to customer's compliance with its obligations stated in this document and any applicable legal requirements, norms and standards concerning customer's products and any use of the product of Infineon Technologies in customer's applications.

The data contained in this document is exclusively intended for technically trained staff. It is the responsibility of customer's technical departments to evaluate the suitability of the product for the intended application and the completeness of the product information given in this document with respect to such application.

For further information on the product, technology, delivery terms and conditions and prices please contact your nearest Infineon Technologies office ([www.infineon.com](http://www.infineon.com)).

Please note that this product is not qualified according to the AEC Q100 or AEC Q101 documents of the Automotive Electronics Council.

### **WARNINGS**

Due to technical requirements products may contain dangerous substances. For information on the types in question please contact your nearest Infineon Technologies office.

Except as otherwise explicitly approved by Infineon Technologies in a written document signed by authorized representatives of Infineon Technologies, Infineon Technologies' products may not be used in any applications where a failure of the product or any consequences of the use thereof can reasonably be expected to result in personal injury.

## X-ON Electronics

Largest Supplier of Electrical and Electronic Components

*Click to view similar products for [Schottky Diodes & Rectifiers](#) category:*

*Click to view products by [Infineon](#) manufacturer:*

Other Similar products are found below :

[MA4E2039](#) [MMBD301M3T5G](#) [RB160M-50TR](#) [D83C](#) [BAS16E6433HTMA1](#) [BAS 3010S-02LRH E6327](#) [BAT 54-02LRH E6327](#)  
[NRVBAF360T3G](#) [NSR05F40QNXT5G](#) [NTE555](#) [JANS1N6640](#) [SS3003CH-TL-E](#) [GA01SHT18](#) [CRS10I30A\(TE85L,QM](#) [MBRA140TRPBF](#)  
[MBRB30H30CT-1G](#) [BAT 15-04R E6152](#) [JANTX1N5712-1](#) [DMJ3940-000](#) [SB007-03C-TB-E](#) [NRVBB20100CTT4G](#) [NRVBM120LT1G](#)  
[NTSB30U100CT-1G](#) [CRG04\(T5L,TEMQ\)](#) [ACDBA1100LR-HF](#) [ACDBA1200-HF](#) [ACDBA240-HF](#) [ACDBA3100-HF](#) [CDBQC0530L-HF](#)  
[ACDBA260LR-HF](#) [ACDBA1100-HF](#) [10BQ015-M3/5BT](#) [NRVBM120ET1G](#) [VSSB410S-M3/5BT](#) [1N5819T-G](#) [PDS1040Q-13](#) [B160BQ-13-F](#)  
[SDM05U20CSP-7](#) [BAS 70-07 E6433](#) [B140S1F-7](#) [HSM560Je3/TR13](#) [DDB2265-000](#) [ZHCS506QTA](#) [HSM190Je3/TR13](#) [B330AF-13](#)  
[ACDBUC0230-HF](#) [SDM1U100S1F-7](#) [MBR10200CTF-G1](#) [CDLL5712](#) [DMF2822-000](#)