

## Diode

Rapid Switching Emitter Controlled Diode

## IDW15E65D2

Emitter Controlled Diode

Data sheet

Industrial Power Control

## Rapid Switching Emitter Controlled Diode

### Features:

- Qualified according to JEDEC for target applications
- 650 V Emitter Controlled technology
- Fast recovery
- Soft switching
- Low reverse recovery charge
- Low forward voltage and stable over temperature
- 175 °C junction operating temperature
- Easy paralleling
- Pb-free lead plating; RoHS compliant

### Applications:

- Boost diode in CCM PFC

### Package pin definition:

- Pin 1 - not connected
- Pin 2 - cathode
- Pin 3 - anode

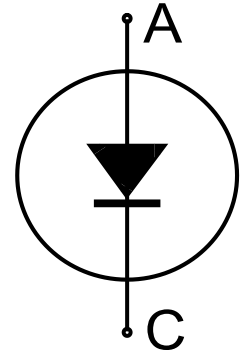

### Key Performance and Package Parameters

| Type       | $V_{rrm}$ | $I_f$ | $V_f, T_{vj}=25^{\circ}\text{C}$ | $T_{vjmax}$ | Marking | Package    |
|------------|-----------|-------|----------------------------------|-------------|---------|------------|
| IDW15E65D2 | 650V      | 15A   | 1.6V                             | 175°C       | E15ED2  | PG-TO247-3 |

**Table of Contents**

|   |    |
|---|----|
| Description .....                         | 2  |
| Table of Contents .....                   | 3  |
| Maximum Ratings .....                     | 4  |
| Thermal Resistance .....                  | 4  |
| Electrical Characteristics .....          | 4  |
| Electrical Characteristics Diagrams ..... | 6  |
| Package Drawing .....                     | 8  |
| Testing Conditions .....                  | 9  |
| Revision History .....                    | 10 |
| Disclaimer .....                          | 10 |

## Emitter Controlled Diode

**Maximum Ratings**

For optimum lifetime and reliability, Infineon recommends operating conditions that do not exceed 80% of the maximum ratings stated in this datasheet.

| Parameter   | Symbol      | Value        | Unit             |
|---|-------------|--------------|------------------|
| Repetitive peak reverse voltage   | $V_{RRM}$   | 650          | V                |
| Diode forward current, limited by $T_{vjmax}$<br>$T_C = 25^\circ\text{C}$<br>$T_C = 100^\circ\text{C}$        | $I_F$       | 30.0<br>15.0 | A                |
| Diode pulsed current, $t_p$ limited by $T_{vjmax}$  | $I_{Fpuls}$ | 45.0         | A                |
| Diode surge non repetitive forward current<br>$T_C = 25^\circ\text{C}$ , $t_p = 8.3\text{ms}$ , sine halfwave | $I_{FSM}$   | 100.0        | A                |
| Power dissipation $T_C = 25^\circ\text{C}$  | $P_{tot}$   | 85.7         | W                |
| Operating junction temperature  | $T_{vj}$    | -40...+175   | $^\circ\text{C}$ |
| Storage temperature   | $T_{stg}$   | -55...+150   | $^\circ\text{C}$ |
| Soldering temperature,<br>wave soldering 1.6 mm (0.063 in.) from case for 10s                                 |             | 260          | $^\circ\text{C}$ |
| Mounting torque, M3 screw<br>Maximum of mounting processes: 3   | $M$         | 0.6          | Nm               |

**Thermal Resistance**

| Parameter  | Symbol        | Conditions | Max. Value | Unit |
|--|---------------|------------|------------|------|
| <b>Characteristic</b>                                      |               |            |            |      |
| Diode thermal resistance, <sup>1)</sup><br>junction - case | $R_{th(j-c)}$ |            | 1.75       | K/W  |
| Thermal resistance<br>junction - ambient                   | $R_{th(j-a)}$ |            | 40         | K/W  |

**Electrical Characteristic, at  $T_{vj} = 25^\circ\text{C}$ , unless otherwise specified**

| Parameter                    | Symbol | Conditions  | Value  |              |                | Unit          |
|------------------------------|--------|---|--------|--------------|----------------|---------------|
|                              |        |   | min.   | typ.         | max.           |               |
| <b>Static Characteristic</b> |        |   |        |              |                |               |
| Diode forward voltage        | $V_F$  | $I_F = 15.0\text{A}$<br>$T_{vj} = 25^\circ\text{C}$<br>$T_{vj} = 175^\circ\text{C}$ | -<br>- | 1.60<br>1.65 | 2.20<br>-      | V             |
| Reverse leakage current      | $I_R$  | $V_R = 650\text{V}$<br>$T_{vj} = 25^\circ\text{C}$<br>$T_{vj} = 175^\circ\text{C}$  | -<br>- | -<br>-       | 40.0<br>4000.0 | $\mu\text{A}$ |

**Electrical Characteristic, at  $T_{vj} = 25^\circ\text{C}$ , unless otherwise specified**

| Parameter  | Symbol | Conditions | Value |      |      | Unit |
|--|--------|------------|-------|------|------|------|
|  |        |            | min.  | typ. | max. |      |
| <b>Dynamic Characteristic</b>  |        |            |       |      |      |      |
| Internal emitter inductance<br>measured 5mm (0.197 in.) from<br>case | $L_E$  |            | -     | 13.0 | -    | nH   |

<sup>1)</sup> Please be aware that in non standard load conditions, due to high  $R_{th(j-c)}$ ,  $T_{vj}$  close to  $T_{vjmax}$  can be reached.

## Emitter Controlled Diode

## Switching Characteristic, Inductive Load

| Parameter | Symbol | Conditions | Value |      |      | Unit |
|-----------|--------|------------|-------|------|------|------|
|           |        |            | min.  | typ. | max. |      |

 Diode Characteristic, at  $T_{vj} = 25^{\circ}\text{C}$ 

|  |              |  |   |       |   |                        |
|--|--------------|--|---|-------|---|------------------------|
| Diode reverse recovery time                                      | $t_{rr}$     | $T_{vj} = 25^{\circ}\text{C}$ ,<br>$V_R = 400\text{V}$ ,<br>$I_F = 15.0\text{A}$ ,<br>$di_F/dt = 1000\text{A}/\mu\text{s}$ ,<br>$L\sigma = 35\text{nH}$ ,<br>$C\sigma = 32\text{pF}$ ,<br>switch IPW60R045CP | - | 30    | - | ns                     |
| Diode reverse recovery charge                                    | $Q_{rr}$     |  | - | 0.20  | - | $\mu\text{C}$          |
| Diode peak reverse recovery current                              | $I_{rrm}$    |  | - | 12.8  | - | A                      |
| Diode peak rate of fall of reverse recovery current during $t_b$ | $di_{rr}/dt$ |  | - | -6500 | - | $\text{A}/\mu\text{s}$ |
| Diode reverse recovery time                                      | $t_{rr}$     | $T_{vj} = 25^{\circ}\text{C}$ ,<br>$V_R = 400\text{V}$ ,<br>$I_F = 15.0\text{A}$ ,<br>$di_F/dt = 200\text{A}/\mu\text{s}$ ,<br>$L\sigma = 35\text{nH}$ ,<br>$C\sigma = 32\text{pF}$ ,<br>switch IPW60R045CP  | - | 47    | - | ns                     |
| Diode reverse recovery charge                                    | $Q_{rr}$     |  | - | 0.12  | - | $\mu\text{C}$          |
| Diode peak reverse recovery current                              | $I_{rrm}$    |  | - | 3.3   | - | A                      |
| Diode peak rate of fall of reverse recovery current during $t_b$ | $di_{rr}/dt$ |  | - | -1500 | - | $\text{A}/\mu\text{s}$ |

## Switching Characteristic, Inductive Load

| Parameter | Symbol | Conditions | Value |      |      | Unit |
|-----------|--------|------------|-------|------|------|------|
|           |        |            | min.  | typ. | max. |      |

 Diode Characteristic, at  $T_{vj} = 175^{\circ}\text{C}/125^{\circ}\text{C}$ 

|  |              |   |   |       |   |                        |
|--|--------------|---|---|-------|---|------------------------|
| Diode reverse recovery time                                      | $t_{rr}$     | $T_{vj} = 175^{\circ}\text{C}$ ,<br>$V_R = 400\text{V}$ ,<br>$I_F = 15.0\text{A}$ ,<br>$di_F/dt = 1000\text{A}/\mu\text{s}$ ,<br>$L\sigma = 35\text{nH}$ ,<br>$C\sigma = 32\text{pF}$ ,<br>switch IPW60R045CP | - | 30    | - | ns                     |
| Diode reverse recovery charge                                    | $Q_{rr}$     |   | - | 0.37  | - | $\mu\text{C}$          |
| Diode peak reverse recovery current                              | $I_{rrm}$    |   | - | 16.9  | - | A                      |
| Diode peak rate of fall of reverse recovery current during $t_b$ | $di_{rr}/dt$ |   | - | -6800 | - | $\text{A}/\mu\text{s}$ |
| Diode reverse recovery time                                      | $t_{rr}$     | $T_{vj} = 125^{\circ}\text{C}$ ,<br>$V_R = 400\text{V}$ ,<br>$I_F = 15.0\text{A}$ ,<br>$di_F/dt = 200\text{A}/\mu\text{s}$ ,<br>$L\sigma = 35\text{nH}$ ,<br>$C\sigma = 32\text{pF}$ ,<br>switch IPW60R045CP  | - | 51    | - | ns                     |
| Diode reverse recovery charge                                    | $Q_{rr}$     |   | - | 0.21  | - | $\mu\text{C}$          |
| Diode peak reverse recovery current                              | $I_{rrm}$    |   | - | 5.0   | - | A                      |
| Diode peak rate of fall of reverse recovery current during $t_b$ | $di_{rr}/dt$ |   | - | -1900 | - | $\text{A}/\mu\text{s}$ |

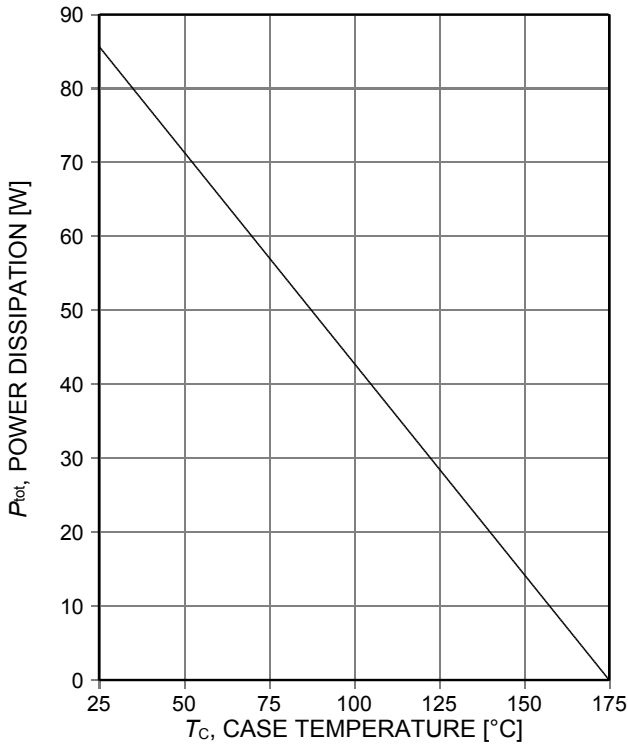

Figure 1. Power dissipation as a function of case temperature ( $T_{vj} \leq 175^\circ\text{C}$ )

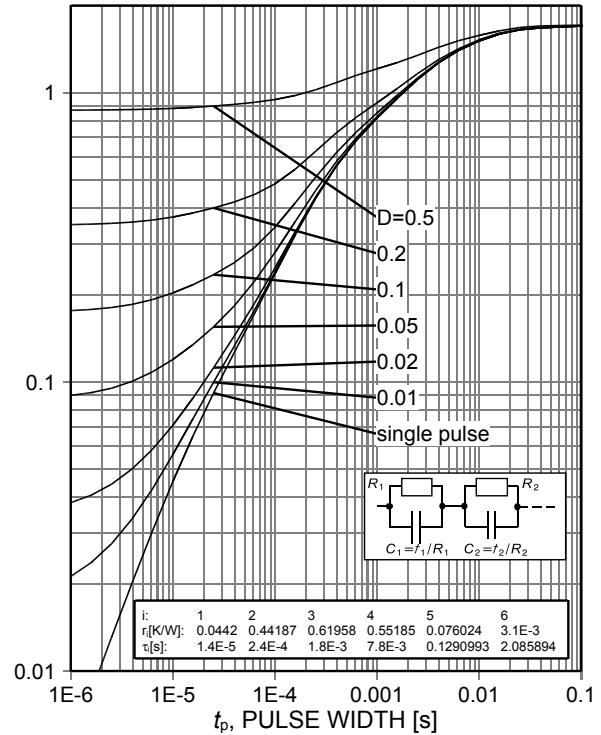

Figure 2. Diode transient thermal impedance as a function of pulse width ( $D = t_p/T$ )

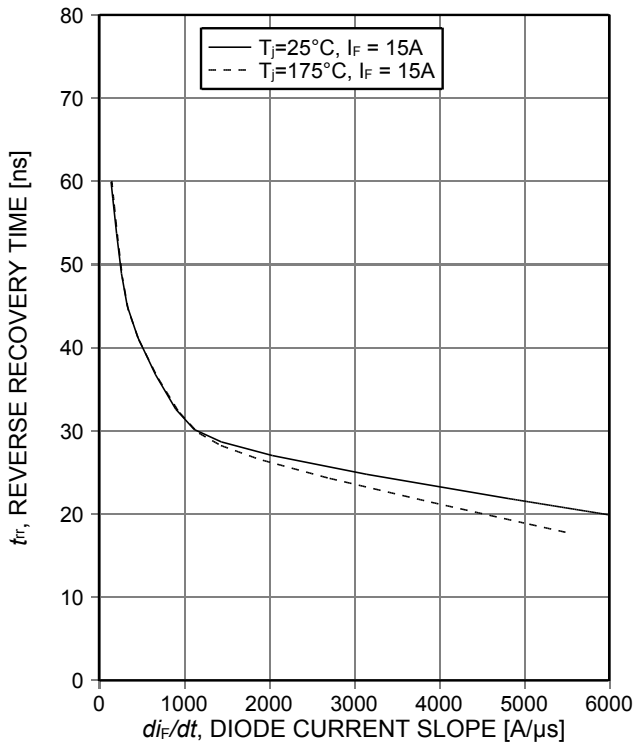

Figure 3. Typical reverse recovery time as a function of diode current slope ( $V_R = 400\text{V}$ )

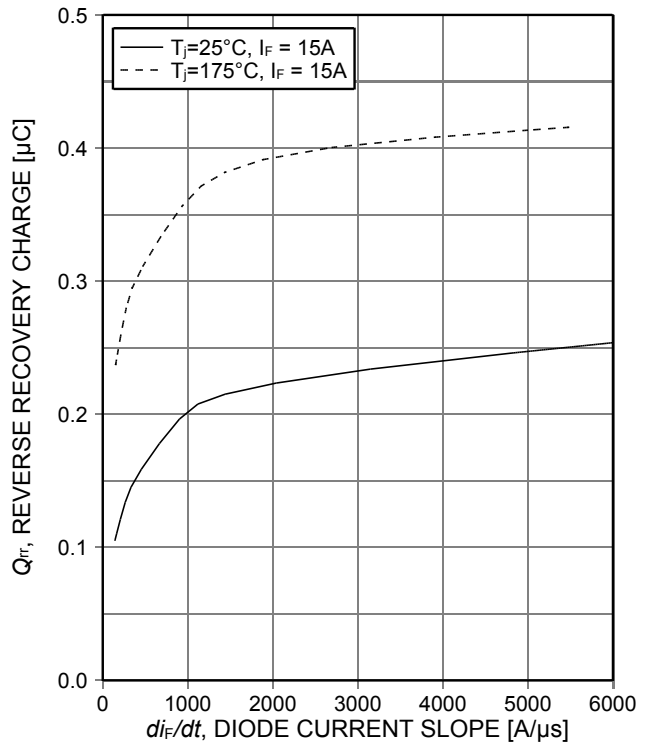

Figure 4. Typical reverse recovery charge as a function of diode current slope ( $V_R = 400\text{V}$ )

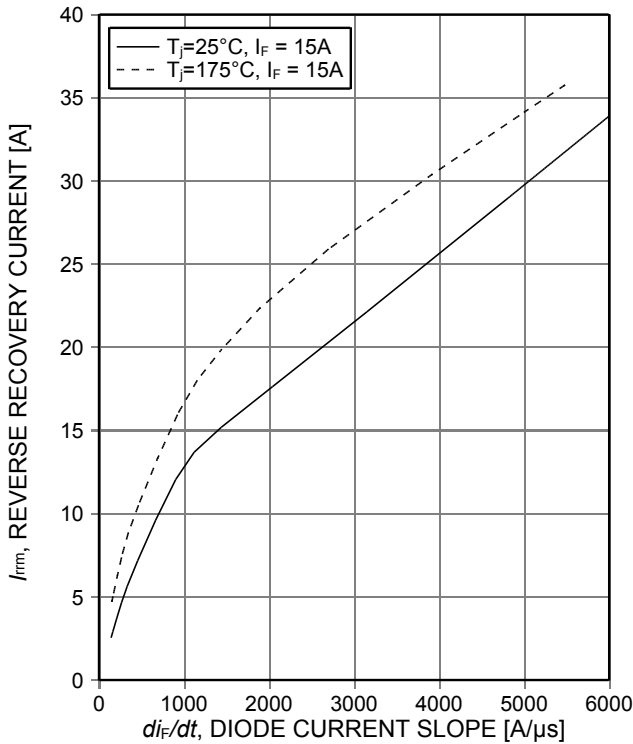

Figure 5. Typical peak reverse recovery current as a function of diode current slope ( $V_R=400V$ )

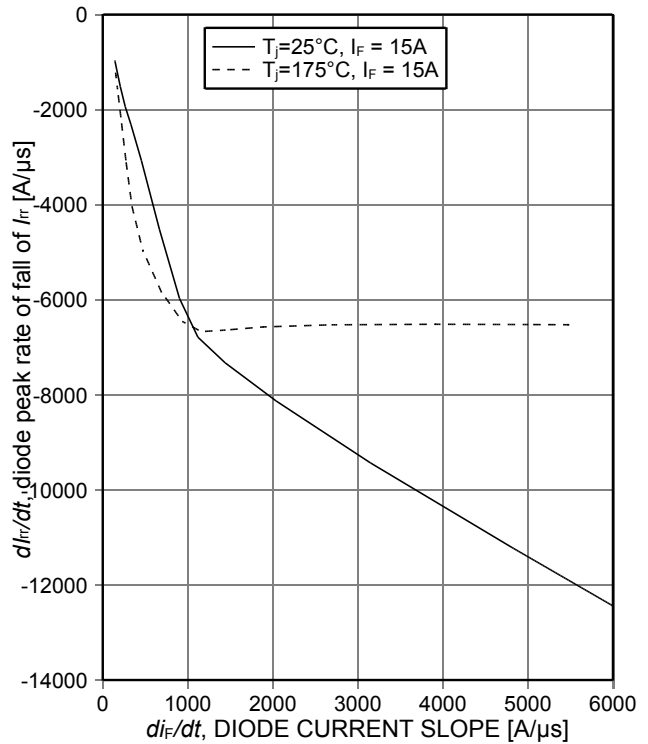

Figure 6. Typical diode peak rate of fall of reverse recovery current as a function of diode current slope ( $V_R=400V$ )

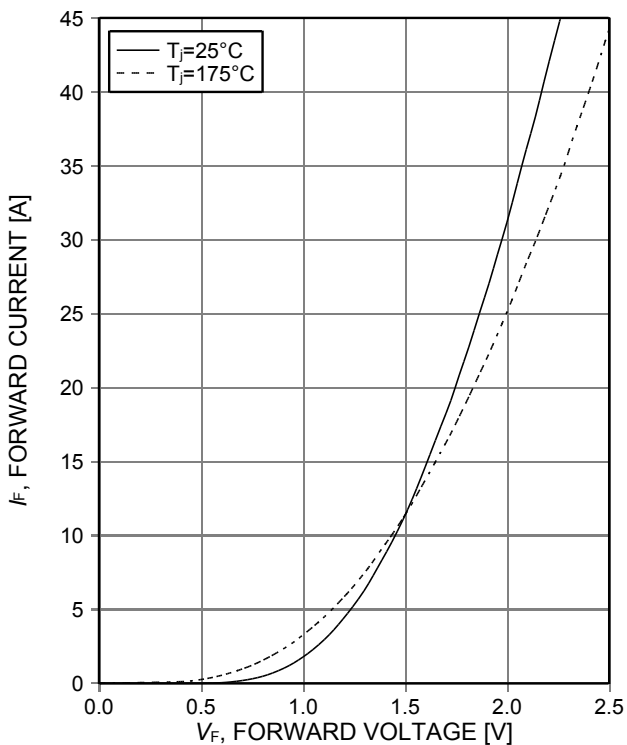

Figure 7. Typical diode forward current as a function of forward voltage

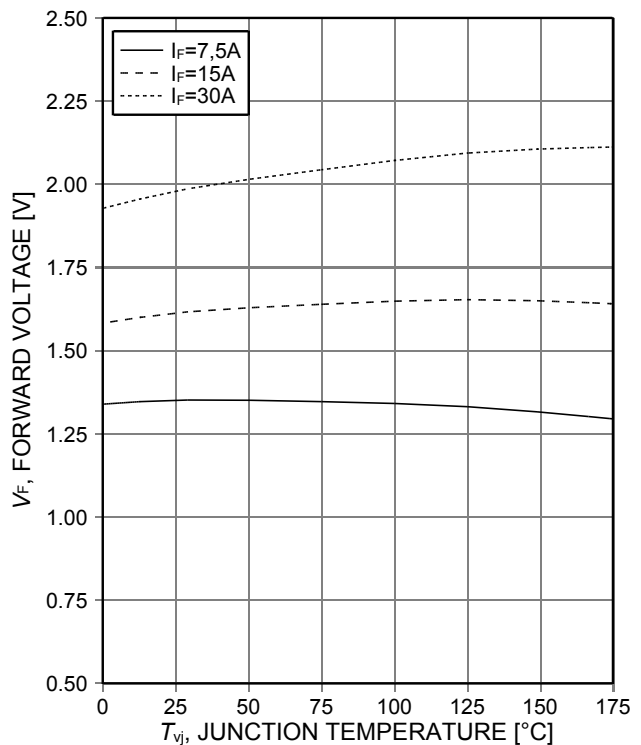
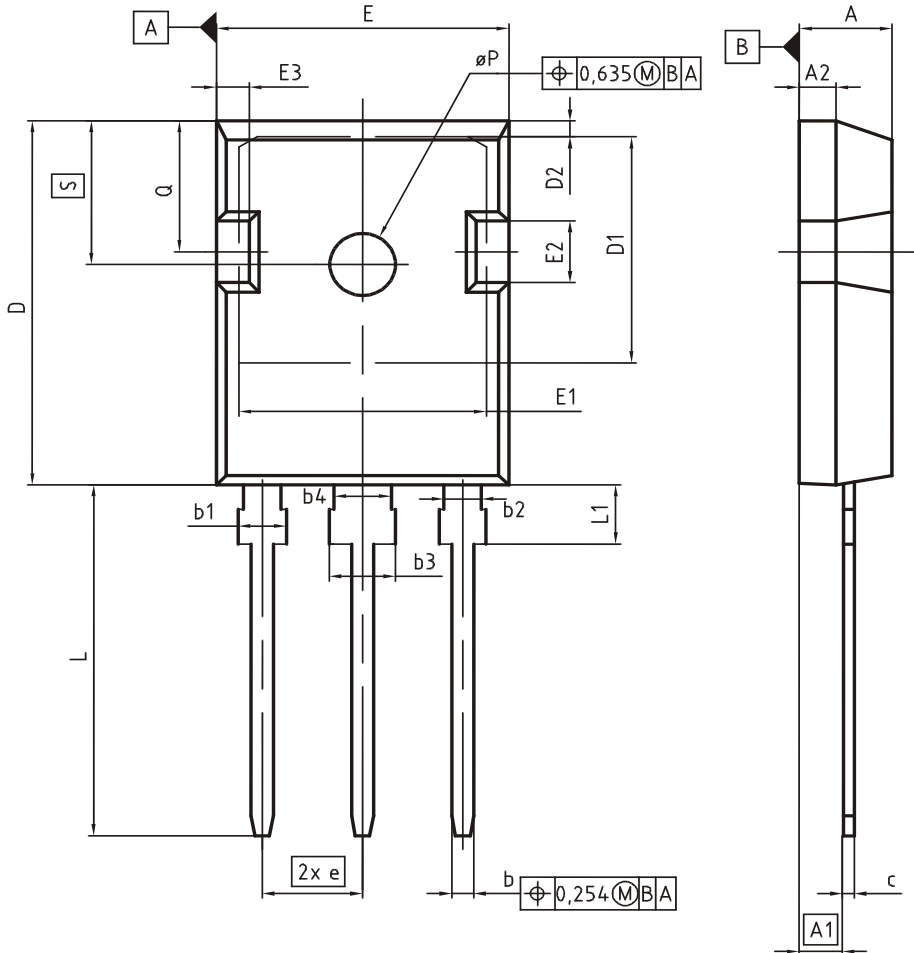

Figure 8. Typical diode forward voltage as a function of junction temperature

PG-TO247-3



| DIM | MILLIMETERS |       | INCHES      |       |
|-----|-------------|-------|-------------|-------|
|     | MIN         | MAX   | MIN         | MAX   |
| A   | 4.83        | 5.21  | 0.190       | 0.205 |
| A1  | 2.27        | 2.54  | 0.089       | 0.100 |
| A2  | 1.85        | 2.16  | 0.073       | 0.085 |
| b   | 1.07        | 1.33  | 0.042       | 0.052 |
| b1  | 1.90        | 2.41  | 0.075       | 0.095 |
| b2  | 1.90        | 2.16  | 0.075       | 0.085 |
| b3  | 2.87        | 3.38  | 0.113       | 0.133 |
| b4  | 2.87        | 3.13  | 0.113       | 0.123 |
| c   | 0.55        | 0.68  | 0.022       | 0.027 |
| D   | 20.80       | 21.10 | 0.819       | 0.831 |
| D1  | 16.25       | 17.65 | 0.640       | 0.695 |
| D2  | 0.95        | 1.35  | 0.037       | 0.053 |
| E   | 15.70       | 16.13 | 0.618       | 0.635 |
| E1  | 13.10       | 14.15 | 0.516       | 0.557 |
| E2  | 3.68        | 5.10  | 0.145       | 0.201 |
| E3  | 1.00        | 2.60  | 0.039       | 0.102 |
| e   | 5.44 (BSC)  |       | 0.214 (BSC) |       |
| N   | 3           |       | 3           |       |
| L   | 19.80       | 20.32 | 0.780       | 0.800 |
| L1  | 4.10        | 4.47  | 0.161       | 0.176 |
| øP  | 3.50        | 3.70  | 0.138       | 0.146 |
| Q   | 5.49        | 6.00  | 0.216       | 0.236 |
| S   | 6.04        | 6.30  | 0.238       | 0.248 |

DOCUMENT NO.  
Z8B00003327

SCALE

EUROPEAN PROJECTION

ISSUE DATE  
09-07-2010

REVISION  
05



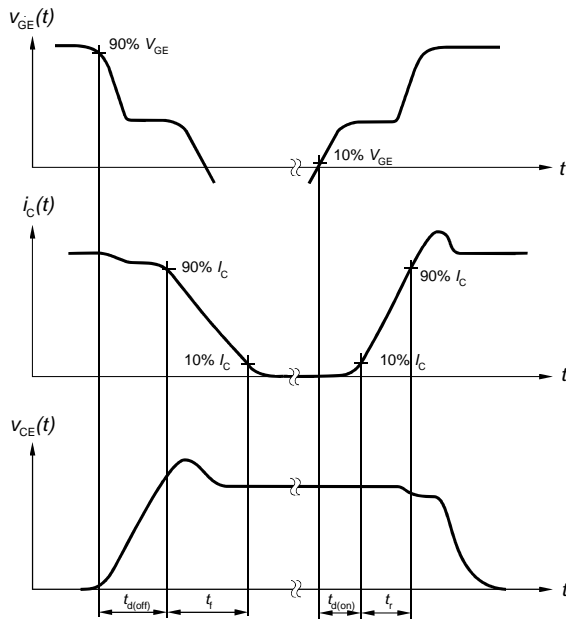

Figure A. Definition of switching times

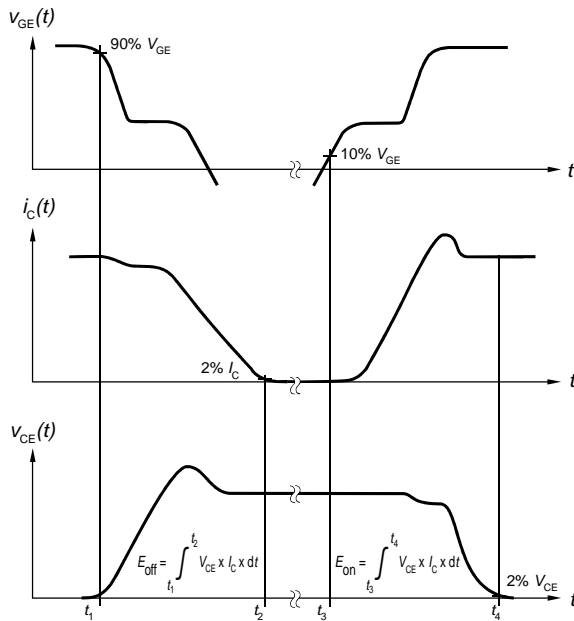

Figure B. Definition of switching losses

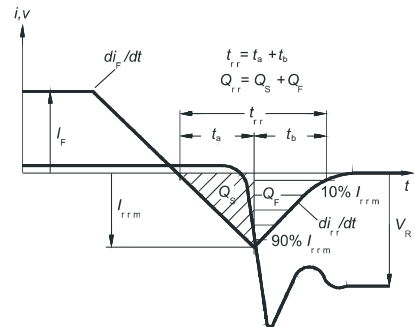

Figure C. Definition of diodes switching characteristics

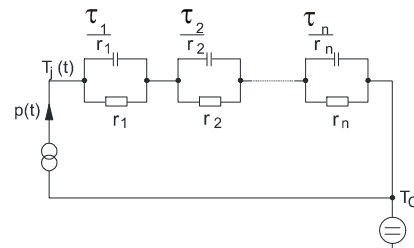

Figure D. Thermal equivalent circuit

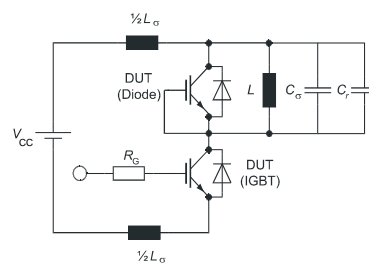

Figure E. Dynamic test circuit  
Parasitic inductance  $L_\sigma$ ,  
Parasitic capacitor  $C_\sigma$ ,  
Relief capacitor  $C_r$   
(only for ZVT switching)

## Revision History

IDW15E65D2

Revision: 2014-08-26, Rev. 2.2

## Previous Revision

| Revision | Date       | Subjects (major changes since last revision)                    |
|----------|------------|---|
| 1.1      | 2013-03-13 | Preliminary data sheet  |
| 2.1      | 2013-12-16 | Final DS / New Marking Pattern                                  |
| 2.2      | 2014-08-26 | VFmax limit reduced according BE test and Qrr at 25°C corrected |

## We Listen to Your Comments

Any information within this document that you feel is wrong, unclear or missing at all ?

Your feedback will help us to continuously improve the quality of this document.

Please send your proposal (including a reference to this document) to: [erratum@infineon.com](mailto:erratum@infineon.com)

## Published by

Infineon Technologies AG

81726 Munich, Germany

81726 München, Germany

© 2014 Infineon Technologies AG

All Rights Reserved.

## Legal Disclaimer

The information given in this document shall in no event be regarded as a guarantee of conditions or characteristics.

With respect to any examples or hints given herein, any typical values stated herein and/or any information regarding the application of the device, Infineon Technologies hereby disclaims any and all warranties and liabilities of any kind, including without limitation, warranties of non-infringement of intellectual property rights of any third party.

## Information

For further information on technology, delivery terms and conditions and prices, please contact the nearest Infineon Technologies Office ([www.infineon.com](http://www.infineon.com)).

## Warnings

Due to technical requirements, components may contain dangerous substances. For information on the types in question, please contact the nearest Infineon Technologies Office.

The Infineon Technologies component described in this Data Sheet may be used in life-support devices or systems and/or automotive, aviation and aerospace applications or systems only with the express written approval of Infineon Technologies, if a failure of such components can reasonably be expected to cause the failure of that life-support, automotive, aviation and aerospace device or system or to affect the safety or effectiveness of that device or system. Life support devices or systems are intended to be implanted in the human body or to support and/or maintain and sustain and/or protect human life. If they fail, it is reasonable to assume that the health of the user or other persons may be endangered.

## X-ON Electronics

Largest Supplier of Electrical and Electronic Components

*Click to view similar products for [Diodes - General Purpose, Power, Switching category](#):*

*Click to view products by [Infineon manufacturer](#):*

Other Similar products are found below :

[RD0306T-H](#) [BAQ33-GS18](#) [BAV17-TR](#) [BAV19-TR](#) [NTE156A](#) [NTE525](#) [NTE571](#) [NTE574](#) [NTE5804](#) [NTE5806](#) [NTE6244](#) [1SS181-TP](#)  
[1SS193,LF](#) [1SS400CST2RA](#) [SDAA13](#) [SHN2D02FUTW1T1G](#) [LS4151GS08](#) [1N4449](#) [1N456A](#) [1N4934-E3/73](#) [1N914B](#) [1N914BTR](#)  
[RFUH20TB3S](#) [BAS 28 E6327](#) [BAV199-TP](#) [BAW56DWQ-7-F](#) [BAW75-TAP](#) [MM230L-CAA](#) [IDW40E65D1](#) [LL4151-GS18](#) [053684A](#)  
[SMMSD4148T3G](#) [707803H](#) [SP000010217](#) [ACDSW4448-HF](#) [CDSZC01100-HF](#) [BAV199E6433HTMA1](#) [BAV70M3T5G](#) [SMBT2001T1G](#)  
[NTE5801](#) [NTE5800](#) [NTE5808](#) [NTE6240](#) [NTE6248](#) [DLM10C-AT1](#) [BAS28-7](#) [BAW56HDW-13](#) [BAS28 TR](#) [VS-HFA04SD60STR-M3](#)  
[NSVM1MA152WKT1G](#)