

## Final datasheet

### Soft and ultra-fast recovery 1200 V Emitter controlled 7 diode for both Industrial and Home Appliance applications

#### Features

- $V_{RRM} = 1200\text{ V}$
- $I_F = 30\text{ A}$
- 1200 V emitter controlled technology
- Maximum junction temperature  $T_{vjmax} = 175^\circ\text{C}$
- Low forward voltage ( $V_F$ )
- Low reverse recovery charge
- Ultrafast recovery times
- Soft recovery characteristics
- Pb-free lead plating; RoHS compliant
- Humidity robust design

#### Potential applications

- String inverter
- EV-Charging
- Heat pump

#### Product validation

- Qualified for industrial applications according to the relevant tests of JEDEC47/20/22

#### Description

Pin definition:

- Pin 1 and backside - Cathode
- Pin 2 - Anode

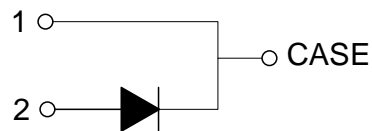

Type	Package	Marking
IDWD30E120D7	PG-TO247-2-STD-NA8.8	E30MD7

## Table of contents

	<b>Description</b> .....	1
	<b>Features</b> .....	1
	<b>Potential applications</b> .....	1
	<b>Product validation</b> .....	1
	<b>Table of contents</b> .....	2
<b>1</b>	<b>Package</b> .....	3
<b>2</b>	<b>Diode</b> .....	3
<b>3</b>	<b>Characteristics diagrams</b> .....	7
<b>4</b>	<b>Package outlines</b> .....	9
<b>5</b>	<b>Testing conditions</b> .....	10
	<b>Revision history</b> .....	11
	<b>Disclaimer</b> .....	12

## 1 Package

**Table 1** Characteristic values

Parameter	Symbol	Note or test condition	Values			Unit
			Min.	Typ.	Max.	
Internal emitter inductance measured 5 mm (0.197 in.) from case	$L_E$			13		nH
Storage temperature	$T_{stg}$		-55		150	°C
Soldering temperature	$T_{sold}$	wave soldering 1.6 mm (0.063 in.) from case for 10 s			260	°C
Mounting torque	$M$	M3 screw, Maximum of mounting processes: 3			0.6	Nm
Thermal resistance, junction-ambient	$R_{th(j-a)}$				40	K/W
Diode thermal resistance, junction-case	$R_{th(j-c)}$			0.74	0.96	K/W

## 2 Diode

**Table 2** Maximum rated values

Parameter	Symbol	Note or test condition		Values	Unit
Repetitive peak reverse voltage	$V_{RRM}$	$T_{vj} \geq 25 \text{ °C}$		1200	V
Diode forward current, limited by $T_{vjmax}$	$I_F$		$T_c = 25 \text{ °C}$	52	A
			$T_c = 100 \text{ °C}$	33	
Diode pulsed current, $t_p$ limited by $T_{vjmax}$	$I_{Fpulse}$			120	A
Diode surge non repetitive forward current, sine halfwave	$I_{FSM}$	$t_p = 10 \text{ ms}$	$T_c = 25 \text{ °C}$	144	A
Diode surge repetitive forward current, sine halfwave <sup>1)</sup>	$I_{FRM}$	$t_p = 10 \text{ ms}$	$T_c = 25 \text{ °C}$	90	A
Power dissipation	$P_{tot}$		$T_c = 25 \text{ °C}$	156	W
			$T_c = 100 \text{ °C}$	78	

1) Not subject to production test. The test was performed with 20k pulses (half-wave rectified sine with 10 ms period).

Table 3 Characteristic values

Parameter	Symbol	Note or test condition	Values			Unit	
			Min.	Typ.	Max.		
Diode forward voltage	$V_F$	$I_F = 30 \text{ A}$	$T_{vj} = 25 \text{ }^\circ\text{C}$		2.5	3	V
			$T_{vj} = 150 \text{ }^\circ\text{C}$		2.35		
			$T_{vj} = 175 \text{ }^\circ\text{C}$		2.3		
Reverse leakage current	$I_R$	$V_R = 1200 \text{ V}$	$T_{vj} = 25 \text{ }^\circ\text{C}$			20	$\mu\text{A}$
			$T_{vj} = 175 \text{ }^\circ\text{C}$		430		
Diode reverse recovery time	$t_{rr}$	$V_R = 800 \text{ V}$	$T_{vj} = 25 \text{ }^\circ\text{C}$ , $I_F = 30 \text{ A}$ , $-di_F/dt = 1000 \text{ A}/\mu\text{s}$		135		ns
			$T_{vj} = 25 \text{ }^\circ\text{C}$ , $I_F = 15 \text{ A}$ , $-di_F/dt = 1000 \text{ A}/\mu\text{s}$		85		
			$T_{vj} = 175 \text{ }^\circ\text{C}$ , $I_F = 30 \text{ A}$ , $-di_F/dt = 1000 \text{ A}/\mu\text{s}$		160		
			$T_{vj} = 175 \text{ }^\circ\text{C}$ , $I_F = 15 \text{ A}$ , $-di_F/dt = 1000 \text{ A}/\mu\text{s}$		110		
Diode reverse recovery charge	$Q_{rr}$	$V_R = 800 \text{ V}$	$T_{vj} = 25 \text{ }^\circ\text{C}$ , $I_F = 30 \text{ A}$ , $-di_F/dt = 1000 \text{ A}/\mu\text{s}$		0.9		$\mu\text{C}$
			$T_{vj} = 25 \text{ }^\circ\text{C}$ , $I_F = 15 \text{ A}$ , $-di_F/dt = 1000 \text{ A}/\mu\text{s}$		0.6		
			$T_{vj} = 175 \text{ }^\circ\text{C}$ , $I_F = 30 \text{ A}$ , $-di_F/dt = 1000 \text{ A}/\mu\text{s}$		1.8		
			$T_{vj} = 175 \text{ }^\circ\text{C}$ , $I_F = 15 \text{ A}$ , $-di_F/dt = 1000 \text{ A}/\mu\text{s}$		1.25		

(table continues...)

Table 3 (continued) Characteristic values

Parameter	Symbol	Note or test condition		Values			Unit
				Min.	Typ.	Max.	
Diode peak reverse recovery current	$I_{rrm}$	$V_R = 800 \text{ V}$	$T_{vj} = 25 \text{ }^\circ\text{C}$ , $I_F = 30 \text{ A}$ , $-di_F/dt = 1000 \text{ A}/\mu\text{s}$		16		A
					14		
					24		
					22		
Diode peak rate of fall of reverse recovery current	$di_{rr}/dt$	$V_R = 800 \text{ V}$	$T_{vj} = 25 \text{ }^\circ\text{C}$ , $I_F = 30 \text{ A}$ , $-di_F/dt = 1000 \text{ A}/\mu\text{s}$		155		$\text{A}/\mu\text{s}$
					195		
					180		
					235		
Reverse recovery energy	$E_{rec}$	$V_R = 800 \text{ V}$	$T_{vj} = 25 \text{ }^\circ\text{C}$ , $I_F = 30 \text{ A}$ , $-di_F/dt = 1000 \text{ A}/\mu\text{s}$		0.35		mJ
					0.2		
					0.65		
					0.45		
Operating junction temperature	$T_{vj}$			-40		175	$^\circ\text{C}$

**Note:** *For optimum lifetime and reliability, Infineon recommends operating conditions that do not exceed 80% of the maximum ratings stated in this datasheet.*

*Electrical Characteristic at  $T_{vj} = 25^{\circ}\text{C}$ , unless otherwise specified.*

*Dynamic test circuit, parasitic inductance  $L_{\sigma} = 27 \text{ nH}$ , parasitic capacitor  $C_{\sigma} = 12 \text{ pF}$  from Fig. E, IKZA40N120CH7 was used as IGBT.*

### 3 Characteristics diagrams

#### Diode transient thermal impedance as a function of pulse width

$$Z_{th(j-c)} = f(t_p)$$

$$D = t_p/T$$

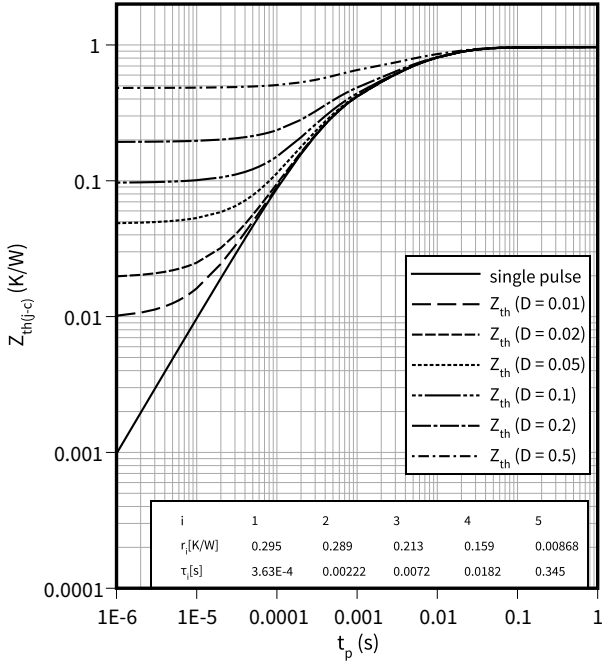

#### Typical diode forward current as a function of forward voltage

$$I_F = f(V_F)$$

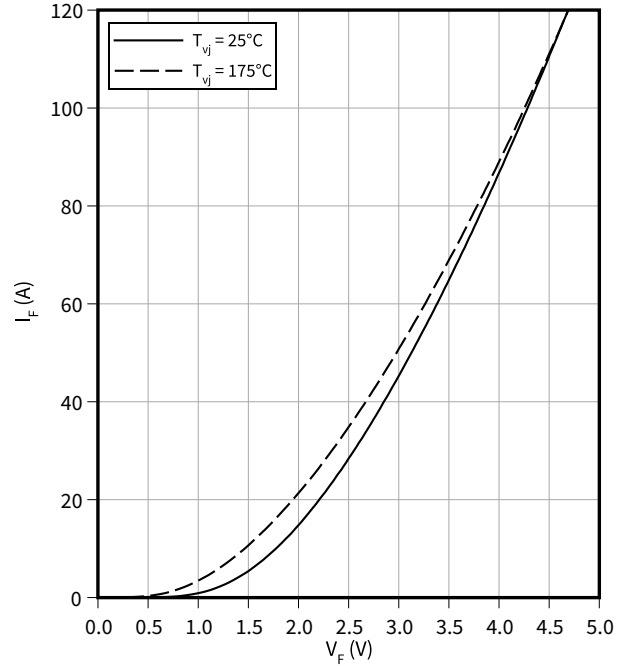

#### Typical diode forward voltage as a function of junction temperature

$$V_F = f(T_{vj})$$

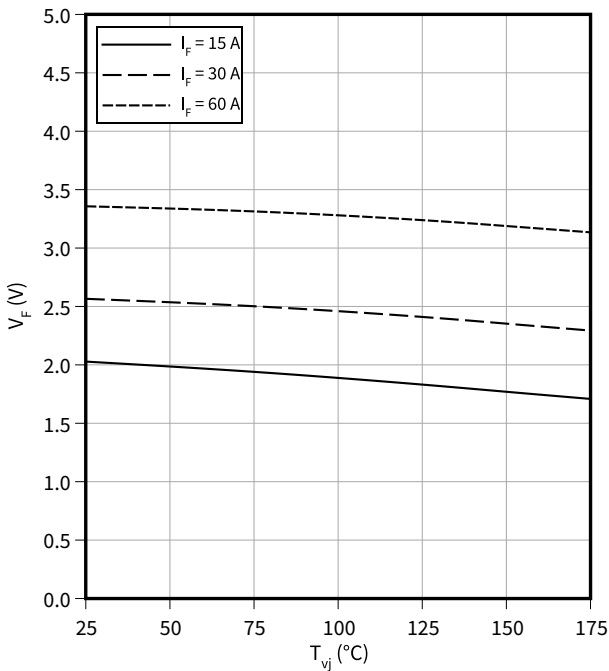

#### Typical reverse recovery time as a function of diode current slope

$$t_{rr} = f(di_F/dt)$$

$$V_R = 800 \text{ V}, I_F = 30 \text{ A}$$

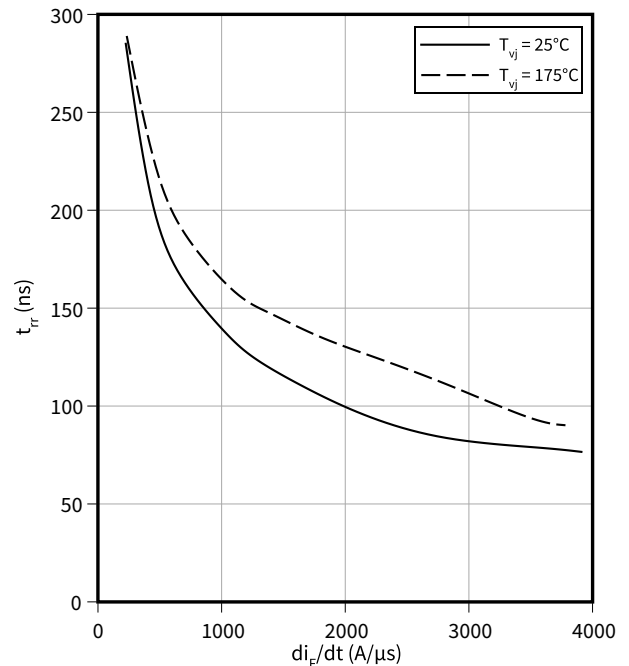

3 Characteristics diagrams

**Typical reverse recovery charge as a function of diode current slope**

$$Q_{rr} = f(di_F/dt)$$

$V_R = 800\text{ V}, I_F = 30\text{ A}$

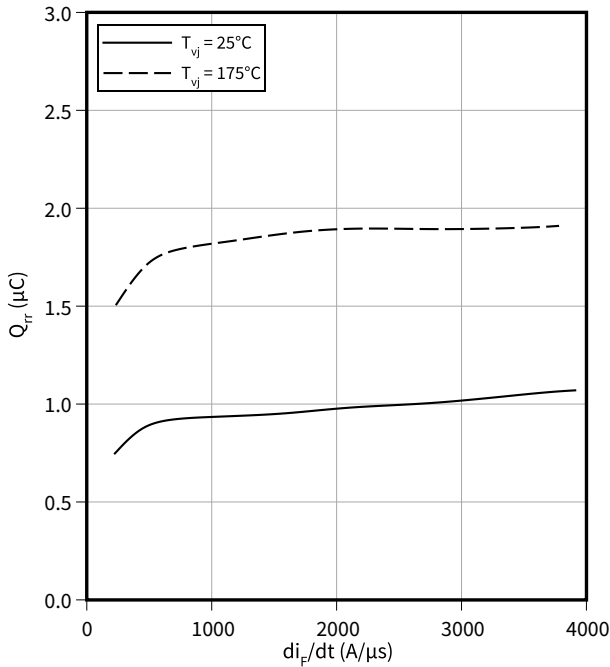

**Typical reverse recovery current as a function of diode current slope**

$$I_{rrm} = f(di_F/dt)$$

$V_R = 800\text{ V}, I_F = 30\text{ A}$

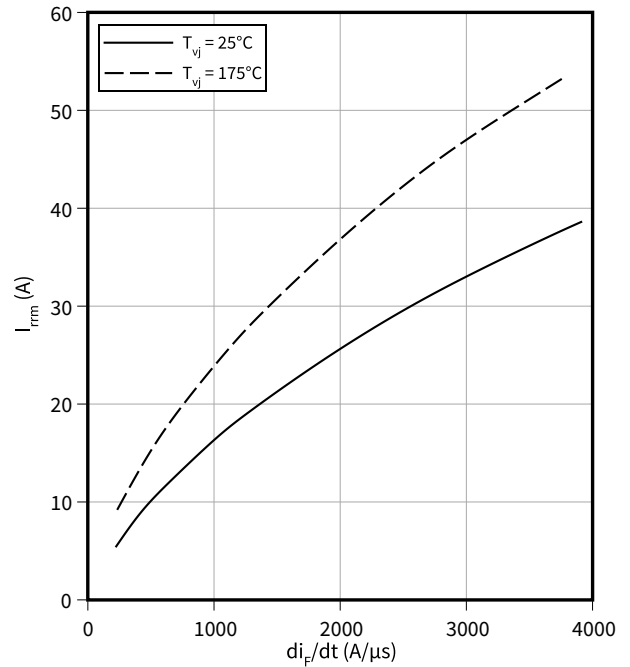

**Typical diode peak rate of fall of reverse recovery current as a function of diode current slope**

$$di_{rr}/dt = f(di_F/dt)$$

$V_R = 800\text{ V}, I_F = 30\text{ A}$

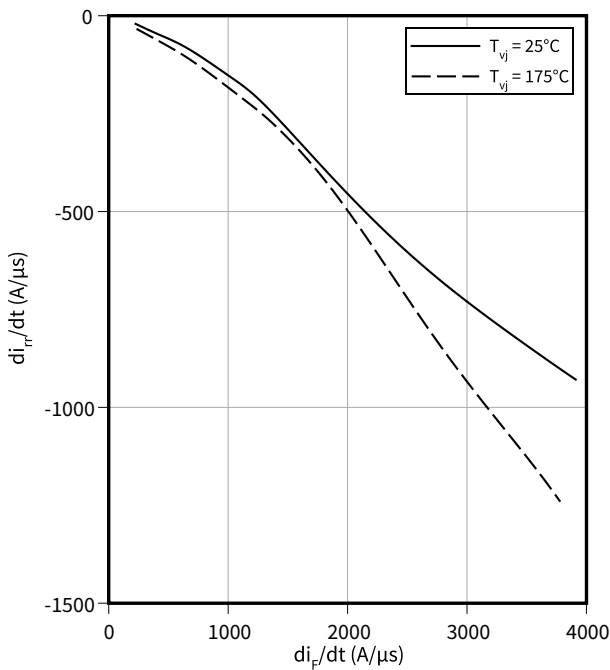

**Typical reverse energy losses as a function of diode current slope**

$$E_{rec} = f(di_F/dt)$$

$V_R = 800\text{ V}, I_F = 30\text{ A}$

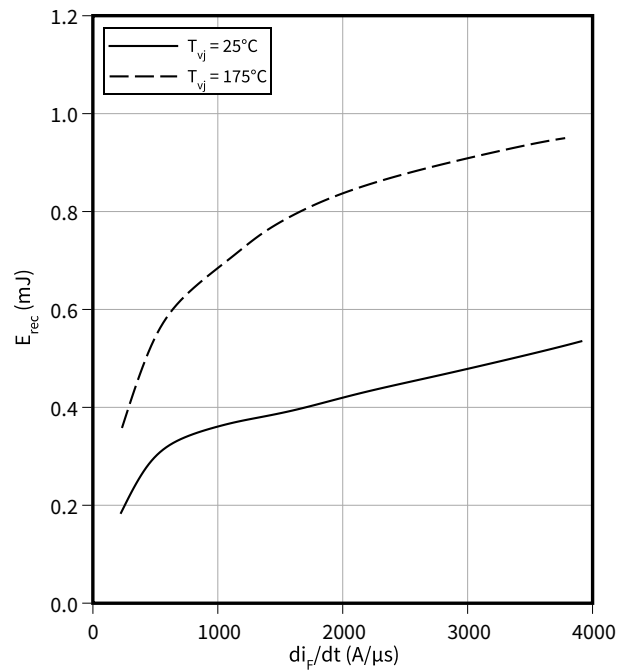



4 Package outlines

PG-TO247-2-STD-NA8.8

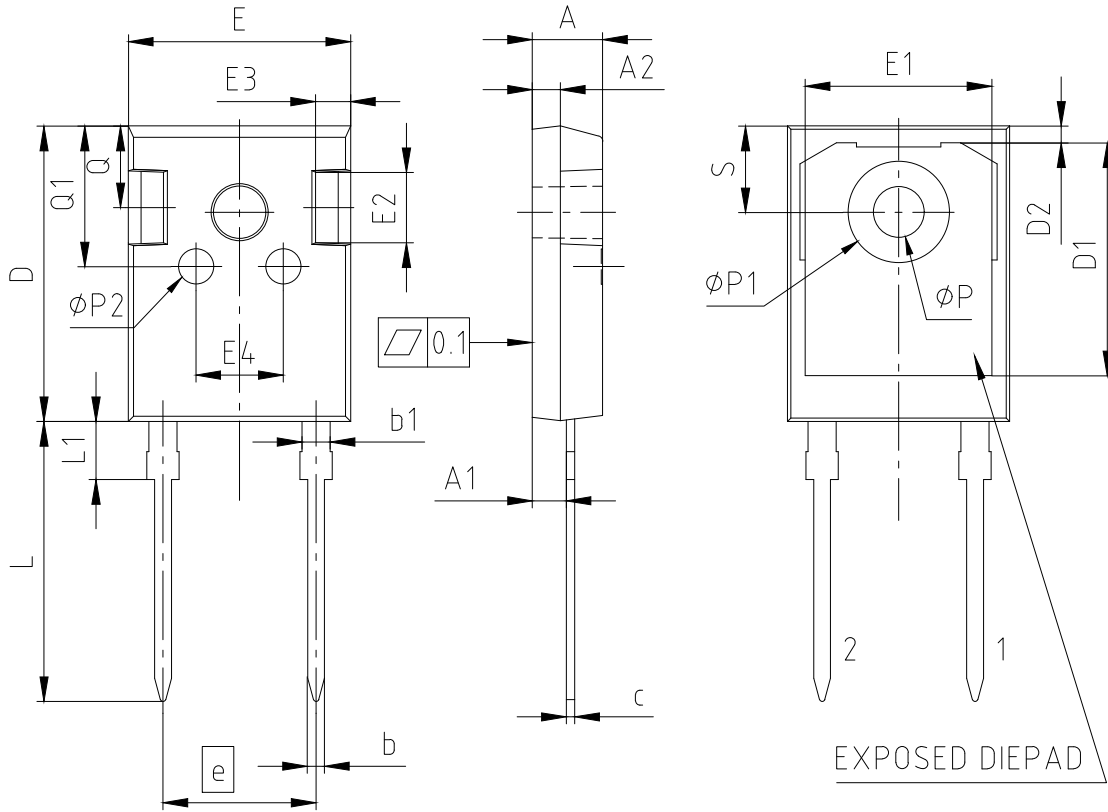

PACKAGE - GROUP NUMBER:		PG-TO247-2-U01			
DIMENSIONS	MILLIMETERS				
	MIN.	MAX.			
A	4.90	5.10	L	19.80	20.10
A1	2.31	2.51	L1	---	4.30
A2	1.90	2.10	øP	3.50	3.70
b	1.16	1.26	øP1	7.00	7.40
b1	1.96	2.06	øP2	2.40	2.60
c	0.59	0.66	Q	5.60	6.00
D	20.90	21.10	Q1	9.80	10.20
D1	16.25	16.85	S	6.05	6.25
D2	1.05	1.35			
E	15.70	15.90			
E1	13.10	13.50			
E2	4.90	5.10			
E3	2.40	2.60			
E4	6.00	6.40			
e	10.88				
N	2				

ALL DIMENSIONS DO NOT INCLUDE MOLD FLASH OR PROTRUSIONS.

Figure 1

5 Testing conditions

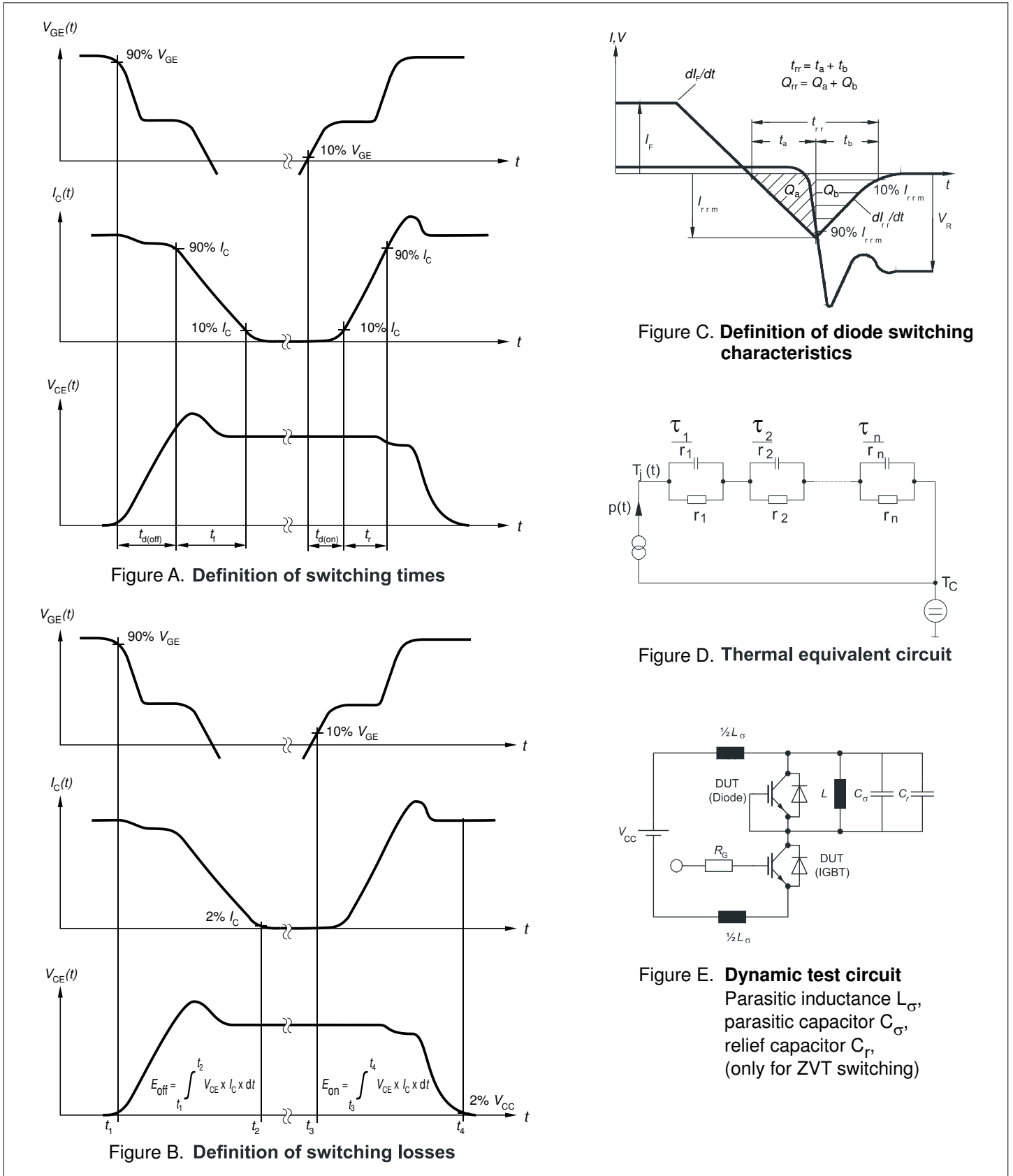

Figure 2

**Revision history**

<b>Document revision</b>	<b>Date of release</b>	<b>Description of changes</b>
1.00	2023-12-15	Final datasheet

## Trademarks

All referenced product or service names and trademarks are the property of their respective owners.

**Edition 2023-12-15**

**Published by**

**Infineon Technologies AG**

**81726 Munich, Germany**

**© 2023 Infineon Technologies AG**

**All Rights Reserved.**

**Do you have a question about any aspect of this document?**

**Email: [erratum@infineon.com](mailto:erratum@infineon.com)**

**Document reference**

**IFX-ABG566-001**

## Important notice

The information given in this document shall in no event be regarded as a guarantee of conditions or characteristics ("Beschaffheitsgarantie").

With respect to any examples, hints or any typical values stated herein and/or any information regarding the application of the product, Infineon Technologies hereby disclaims any and all warranties and liabilities of any kind, including without limitation warranties of non-infringement of intellectual property rights of any third party.

In addition, any information given in this document is subject to customer's compliance with its obligations stated in this document and any applicable legal requirements, norms and standards concerning customer's products and any use of the product of Infineon Technologies in customer's applications.

The data contained in this document is exclusively intended for technically trained staff. It is the responsibility of customer's technical departments to evaluate the suitability of the product for the intended application and the completeness of the product information given in this document with respect to such application.

Please note that this product is not qualified according to the AEC Q100 or AEC Q101 documents of the Automotive Electronics Council.

## Warnings

Due to technical requirements products may contain dangerous substances. For information on the types in question please contact your nearest Infineon Technologies office.

Except as otherwise explicitly approved by Infineon Technologies in a written document signed by authorized representatives of Infineon Technologies, Infineon Technologies' products may not be used in any applications where a failure of the product or any consequences of the use thereof can reasonably be expected to result in personal injury.

## X-ON Electronics

Largest Supplier of Electrical and Electronic Components

*Click to view similar products for [Small Signal Switching Diodes](#) category:*

*Click to view products by [Infineon](#) manufacturer:*

Other Similar products are found below :

[BAS16E6433HTMA1](#) [SHN2D02FUTW1T1G](#) [BAS 16-02L E6327](#) [BAS 16-02V H6327](#) [BAS 21U E6327](#) [BAS 28 E6327](#) [BAW56DWQ-7-F](#)  
[BAW56M3T5G](#) [IDW40E65D1](#) [IDW40E65D2](#) [SMMSD4148T3G](#) [NSVDAN222T1G](#) [CDSZC01100-HF](#) [BAS28-7](#) [JANTX1N6640](#)  
[BAW56HDW-13](#) [BAV99TQ-13-F](#) [SMSD1002T1G](#) [LS4148](#) [IDV15E65D2](#) [W0503RH200S0L](#) [M0268SJ200NLF](#) [M0268RJ200NLF](#)  
[DAN217U-TP](#) [BAV21W-HE3\\_A-08](#) [BAV99-HE3\\_A-08](#) [BAW56-HE3\\_A-08](#) [BAS16-HE3\\_A-08](#) [BAS16D-HE3\\_A-08](#) [BAV19W-HE3\\_A-08](#)  
[BAS20-HE3\\_A-08](#) [BAL99-HE3\\_A-08](#) [BAV23C-HE3\\_A-08](#) [DHVSD3004BRM-7](#) [DLLFSD01LP3Q-7](#) [BAS16VVQ-7](#)  
[IDWD100E120D7XKSA1](#) [IDWD120E120D7XKSA1](#) [IDWD140E120D7XKSA1](#) [IDWD30E120D7XKSA1](#) [IDWD40E120D7XKSA1](#)  
[IDWD50E120D7XKSA1](#) [IDWD60E120D7XKSA1](#) [IDWD75E120D7XKSA1](#) [BAS21TWQ-7](#) [BAV21WQ-7-F](#) [MMBD4448HADWQ-7-F](#)  
[BAV23AQ-13-F](#) [1N4148WSQ-13-F](#) [BAW56WQ-7-F](#)