

IFX24401

Low Dropout Voltage Regulator

IFX24401TEV50
IFX24401ELV50

Data Sheet

Rev. 1.02, 2009-12-10

Standard Power



1 Overview

Features

- Output voltage 5 V \pm 2%
- Ultra low current consumption: 20 μ A (typ.)
- 300 mA current capability
- Enable input
- Very low-drop voltage
- Short circuit protection
- Overtemperature protection
- Low Dropout Voltage, 250mV (typ.)
- High Input Voltage 45 V
- Temperature Range $-40\text{ }^{\circ}\text{C} \leq T_j \leq 125\text{ }^{\circ}\text{C}$
- Green Product (RoHS compliant)

Applications

- Battery powered devices (e.g. Handheld GPS)
- Portable Radios
- HDTV Televisions
- Game Consoles
- Network Routers

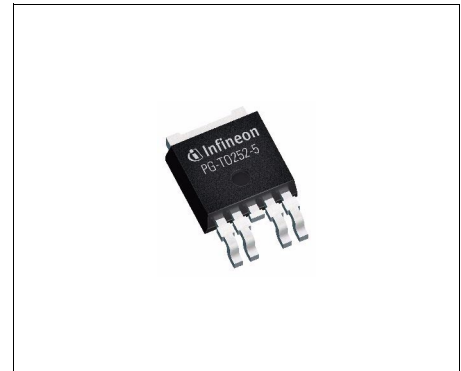

PG-TO252-5

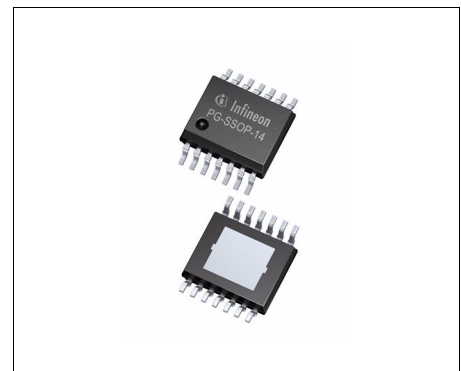

PG-SSOP-14

For automotive and transportation applications, please refer to the Infineon TLE and TLF voltage regulator series.

Functional Description

The IFX24401 is a monolithic integrated low-drop voltage regulator for load currents up to 300 mA. The output voltage is regulated to $V_{Q,nom} = 5.0\text{ V}$ with an accuracy of \pm 2%. A sophisticated design allows stable operation with low ESR ceramic output capacitors down to 470 nF. The device is designed for the harsh environments. Therefore it is protected against overload, short circuit and overtemperature conditions. Due to its ultra low stand-by current consumption of 20 μ A (typ.) the IFX24401 is ideal for use in battery powered applications. The regulator can be shut down via an Enable input which further reduces the current consumption to 5 μ A (typ.). An integrated output sink current circuitry keeps the voltage at the Output pin Q below 5.5 V even when reverse currents are applied. Thus connected devices are protected from overvoltage damage.

Type	Package	Marking
IFX24401TEV50	PG-TO252-5	2440150
IFX24401ELV50	PG-SSOP-14	24401V50

2 Block Diagram

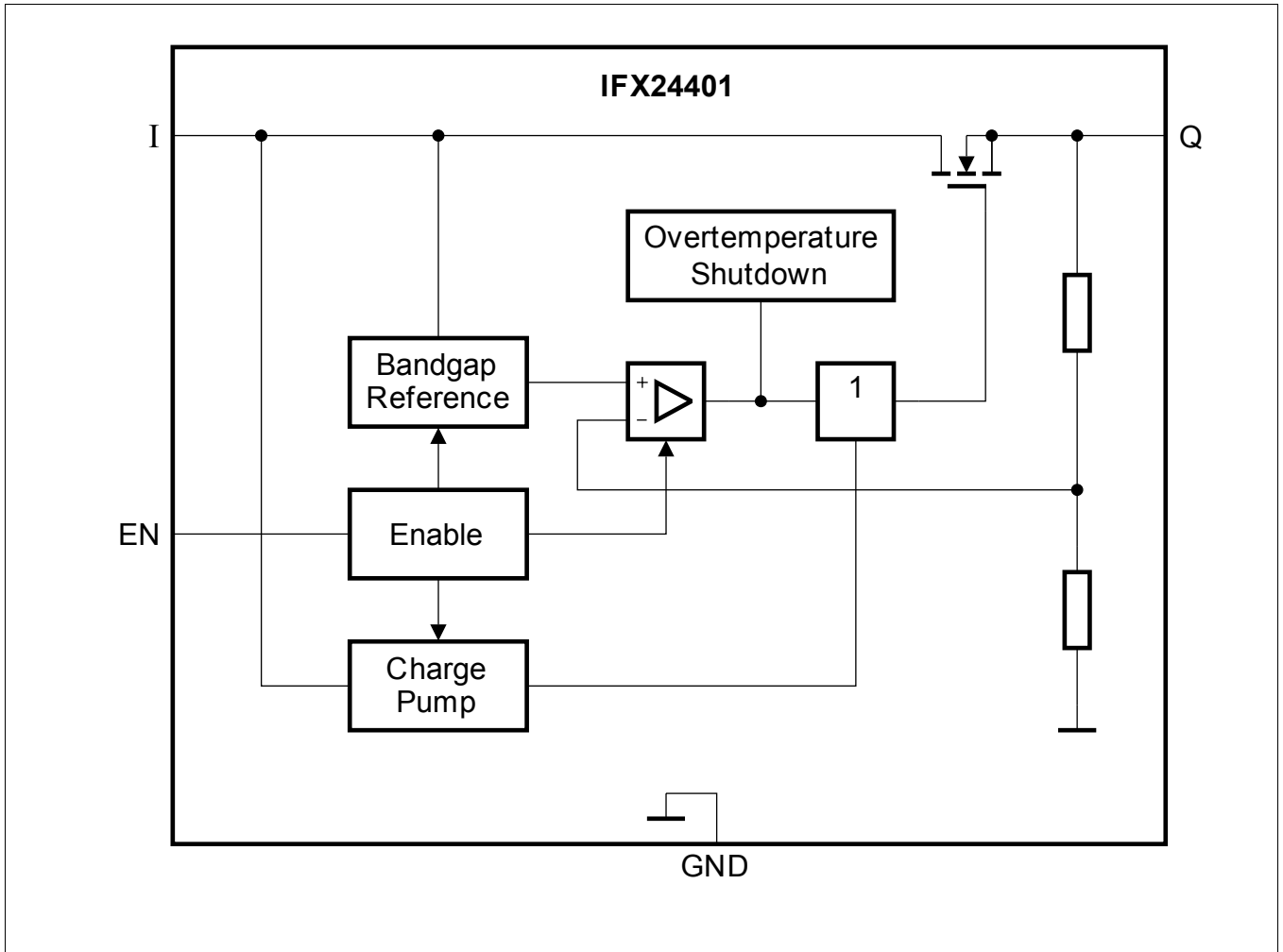

Figure 1 Block Diagram

3 Pin Configuration

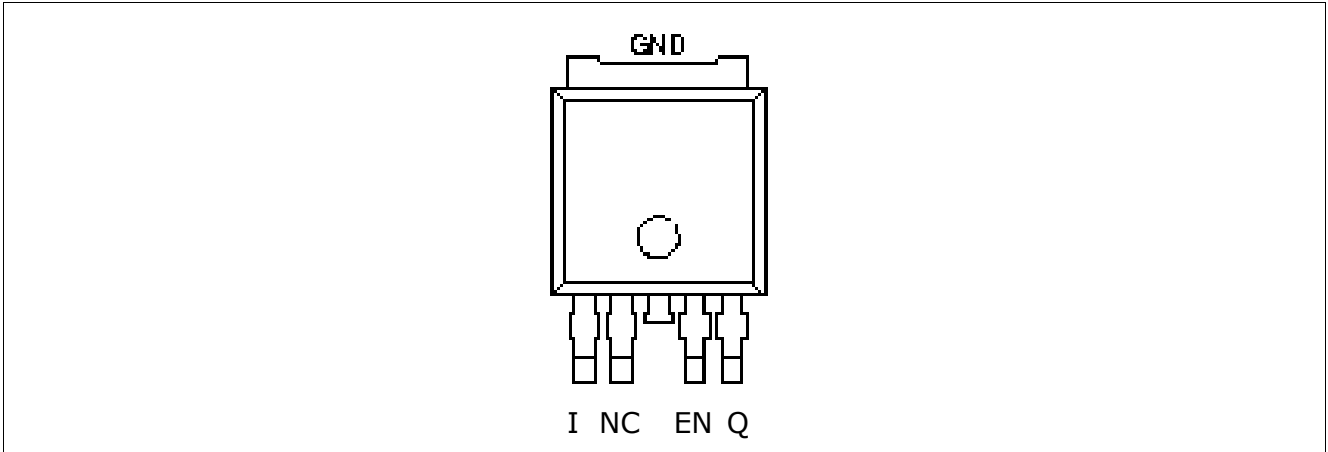

Figure 2 Pin Configuration PG-TO252-5 (top view)

3.1 Pin Definitions and Functions (PG-TO252-5)

Pin	Symbol	Function
1	I	Input Connect ceramic capacitor between I and GND
2	N.C.	No Connect May be open or connected to GND
3	GND	Ground Internally connected to heat slug
4	EN	Enable Input Low signal level disables the regulator. Pull-down resistor is integrated.
5	Q	Output Place capacitor between Q pin and GND. Capacitor placement should be close to pin. Refer to capacitance and ESR requirements in "Functional Range" on Page 6
Heat Slug	--	Heat Slug Connect to board GND and heatsink

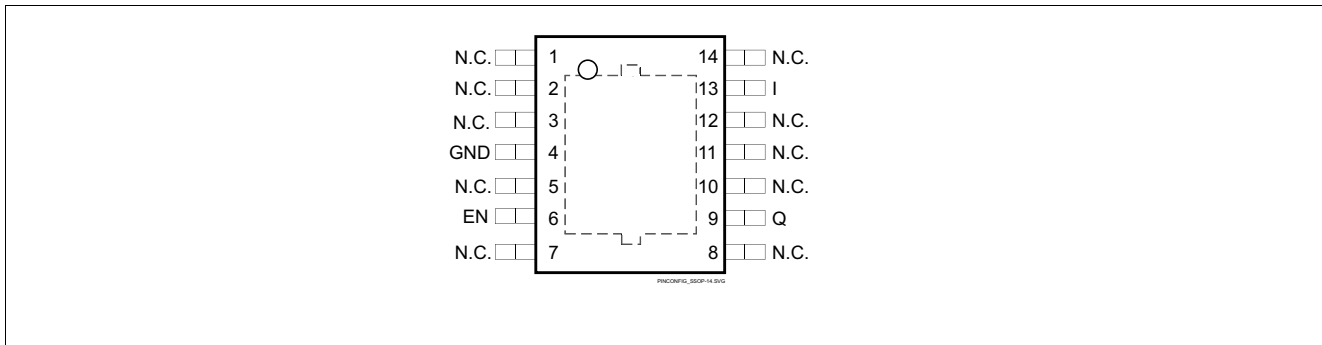

Figure 3 Pin Configuration PG-SSOP-14 (top view)

3.2 Pin Definitions and Functions (PG-SSOP-14)

Pin	Symbol	Function
1,2,3,5,7	N.C.	No Connect May be open or connected to GND
4	GND	Ground
6	EN	Enable Input Low signal level disables the regulator. Pull-down resistor is integrated.
8,10,11,12,14	N.C.	No Connect May be open or connected to GND
9	Q	Output Place capacitor between Q pin and GND. Capacitor placement should be close to pin. Refer to capacitance and ESR requirements in “Functional Range” on Page 6
13	I	Input Connect ceramic capacitor between I and GND
Pad		Exposed Pad Connect to board GND and heatsink

4 General Product Characteristics

4.1 Absolute Maximum Ratings

Absolute Maximum Ratings¹⁾

$T_j = -40\text{ °C}$ to 150 °C ; all voltages with respect to ground, positive current flowing into pin (unless otherwise specified)

Parameter	Symbol	Limit Values		Unit	Test Condition
		Min.	Max.		
Input I					
Voltage	V_I	-0.3	45	V	–
Current	I_I	-1	–	mA	–
Enable EN					
Voltage	V_{EN}	-0.3	45	V	Observe current limit $I_{EN,max}^{2)}$
Current	I_{EN}	-1	1	mA	–
Output Q					
Voltage	V_Q	-0.3	5.5	V	–
Voltage	V_Q	-0.3	6.2	V	$t < 10\text{ s}^{3)}$
Current	I_Q	-1	–	mA	–
Temperature					
Junction temperature	T_j	-40	150	°C	–
Storage temperature	T_{stg}	-50	150	°C	–

1) Not subject to production test, specified by design.

2) External resistor required to keep current below absolute maximum rating when voltages $\geq 5.5\text{ V}$ are applied.

3) Exposure to these absolute maximum ratings for extended periods ($t > 10\text{ s}$) may affect device reliability.

Note: Stresses above the ones listed here may cause permanent damage to the device. Exposure to absolute maximum rating conditions for extended periods may affect device reliability.

Note: Integrated protection functions are designed to prevent IC destruction under fault conditions described in the data sheet. Fault conditions are considered as "outside" normal operating range. Protection functions are not designed for continuous repetitive operation.

4.2 Functional Range

Parameter	Symbol	Limit Values		Unit	Remarks
		Min.	Max.		
Input voltage	V_I	5.5	42	V	–
Junction temperature	T_j	-40	125	°C	–
Output Capacitor	C_Q	470	–	nF	¹⁾
	ESR (C_Q)	–	10	Ω	$f = 10\text{ kHz}$

1) The minimum output capacitance requirement is applicable for a worst case capacitor tolerance of 30%

Note: In the operating range, the functions given in the circuit description are fulfilled.

4.3 Thermal Resistance

Pos.	Parameter	Symbol	Limit Value			Unit	Conditions
			Min.	Typ.	Max.		
IFX24401TEV50 (PG-TO252-5,)							
4.3.1	Junction to Case ¹⁾	R_{thJC}	–	4	–	K/W	measured to pin 5
4.3.2	Junction to Ambient ¹⁾	R_{thJA}	–	115	–	K/W	Footprint only ²⁾
4.3.3			–	57	–	K/W	300mm ² heatsink area on PCB ²⁾
4.3.4			–	42	–	K/W	600mm ² heatsink area on PCB ²⁾
IFX24401ELV50 (PG-SSOP-14)							
4.3.5	Junction to Case ¹⁾	R_{thJC}	–	7	–	K/W	measured to pin 5
4.3.6	Junction to Ambient ¹⁾	R_{thJA}	–	120	–	K/W	Footprint only ²⁾
4.3.7			–	59	–	K/W	300mm ² heatsink area on PCB ²⁾
4.3.8			–	49	–	K/W	600mm ² heatsink area on PCB ²⁾

1) not subject to production test, specified by design

2) EIA/JESD 52_2, FR4, 80 × 80 × 1.5 mm; 35μ Cu, 5μ Sn

Table 1 Electrical Characteristics
 $V_I = 13.5 \text{ V}; V_{EN} = 5 \text{ V}; -40 \text{ }^\circ\text{C} < T_j < 125 \text{ }^\circ\text{C}$ (unless otherwise specified)

Parameter	Symbol	Limit Values			Unit	Measuring Condition
		Min.	Typ.	Max.		
Output Q						
Output voltage	V_Q	4.9	5.0	5.1	V	$0.1 \text{ mA} < I_Q < 300 \text{ mA};$ $6 \text{ V} < V_I < 16 \text{ V}$
Output voltage	V_Q	4.9	5.0	5.1	V	$0.1 \text{ mA} < I_Q < 100 \text{ mA};$ $6 \text{ V} < V_I < 40 \text{ V}$
Output current limit	$I_{Q,LIM}$	320	–	–	mA	1)
Output current limit	$I_{Q,LIM}$	–	–	800	mA	$V_Q = 0 \text{ V}$
Current consumption; $I_q = I_I - I_Q$	I_q	–	20	30	μA	$I_Q = 0.1 \text{ mA};$ $T_j = 25 \text{ }^\circ\text{C}$
Current consumption; $I_q = I_I - I_Q$	I_q	–	–	40	μA	$I_Q = 0.1 \text{ mA};$ $T_j \leq 80 \text{ }^\circ\text{C}$
Quiescent current; Disabled	I_q	–	5	9	μA	$V_{EN} = 0 \text{ V};$ $T_j < 80 \text{ }^\circ\text{C}$
Drop voltage	V_{dr}	–	250	500	mV	$I_Q = 200 \text{ mA};$ $V_{dr} = V_I - V_Q$ 1)
Load regulation	$\Delta V_{Q, lo}$	-40	15	40	mV	$I_Q = 5 \text{ mA to } 250 \text{ mA}$
Line regulation	$\Delta V_{Q, li}$	-20	5	20	mV	$V_I = 10 \text{ V to } 32 \text{ V};$ $I_Q = 5 \text{ mA}$
Power supply ripple rejection	$PSRR$	–	60	–	dB	$f_r = 100 \text{ Hz};$ $V_r = 0.5 \text{ Vpp}$
Temperature output voltage drift	dV_Q/dT	–	0.5	–	mV/K	–
Enable Input EN						
Turn-on Voltage	$V_{EN ON}$	3.1	–	–	V	$V_Q \geq 4.9 \text{ V}$
Turn-off Voltage	$V_{EN OFF}$	–	–	0.8	V	$V_Q \leq 0.3 \text{ V}$
H-input current	$I_{EN ON}$	–	3	4	μA	$V_{EN} = 5 \text{ V}$
L-input current	$I_{EN OFF}$	–	0.5	1	μA	$V_{EN} = 0 \text{ V};$ $T_j < 80 \text{ }^\circ\text{C}$

 1) Measured when the output voltage V_Q has dropped 100 mV from the nominal value obtained at $V_I = 13.5 \text{ V}$.

5 Typical Performance Characteristics

Current Consumption I_q versus Junction Temperature T_j

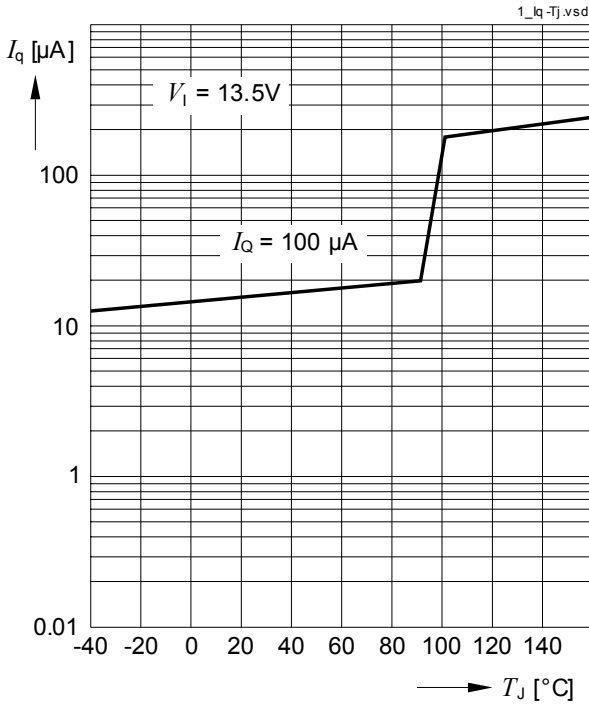

Current Consumption I_q versus Input Voltage V_i

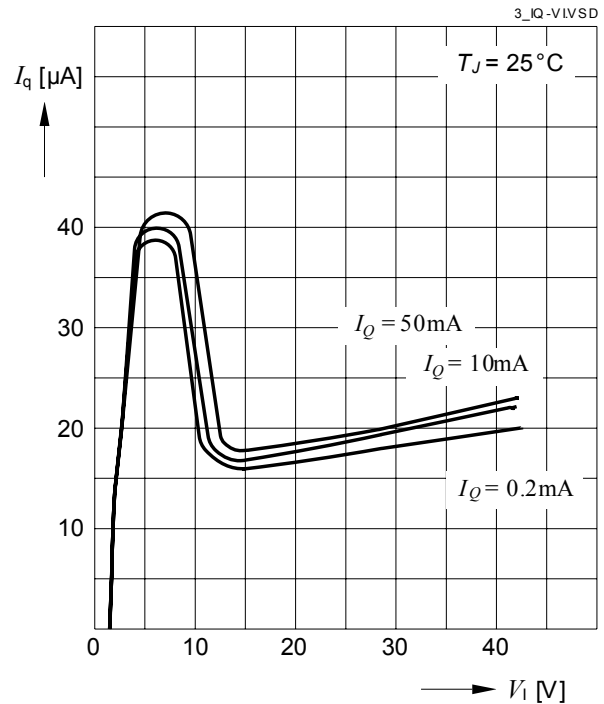

Current Consumption I_q versus Output Current I_Q

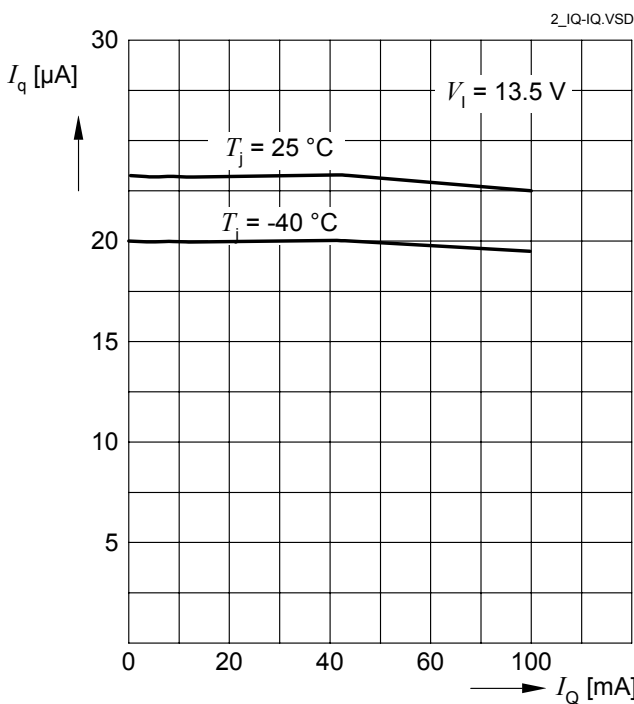

Output Voltage V_Q versus Junction Temperature T_j

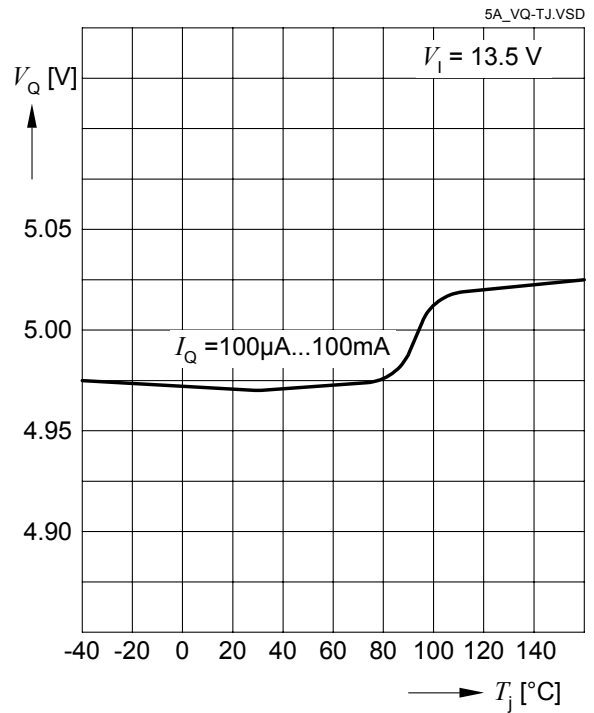

Typical Performance Characteristics

Dropout Voltage V_{dr} versus Output Current I_Q

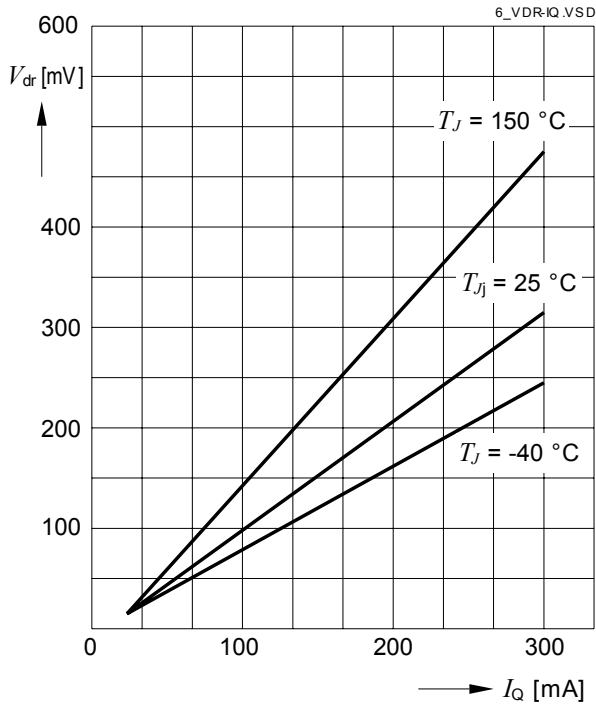

Maximum Output Current I_Q versus Junction Temperature T_j

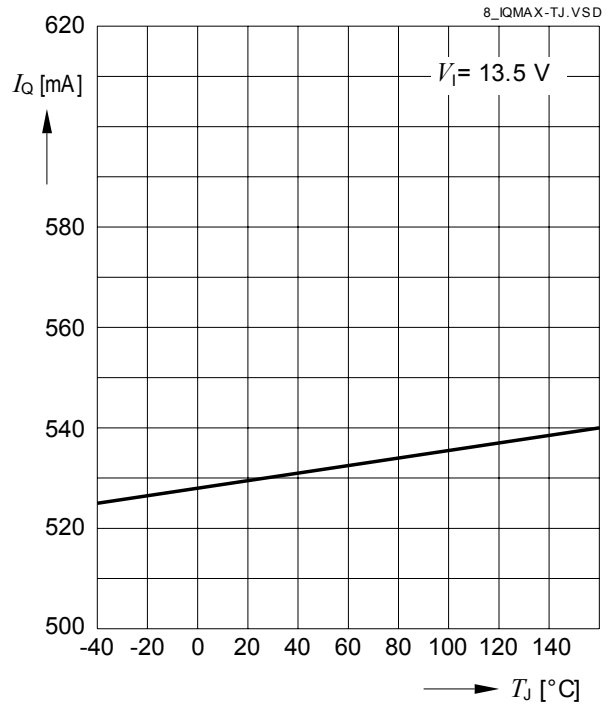

Dropout Voltage V_{dr} versus Junction Temperature

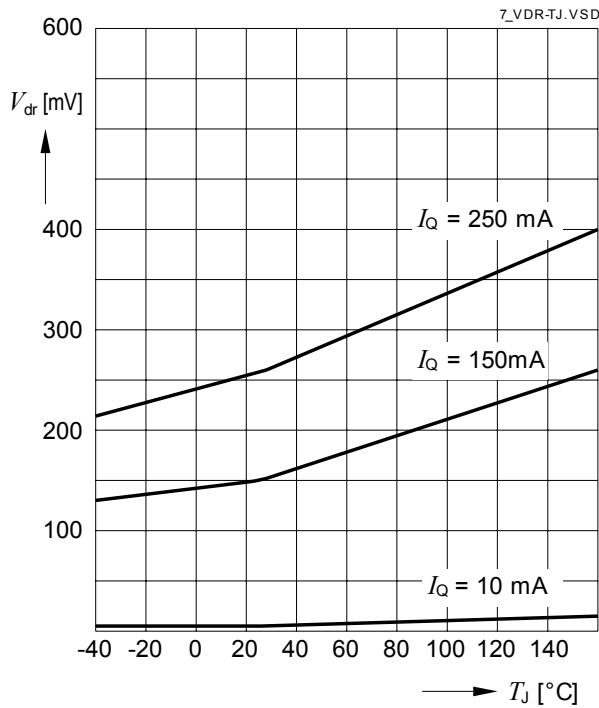

Maximum Output Current I_Q versus Input Voltage V_i

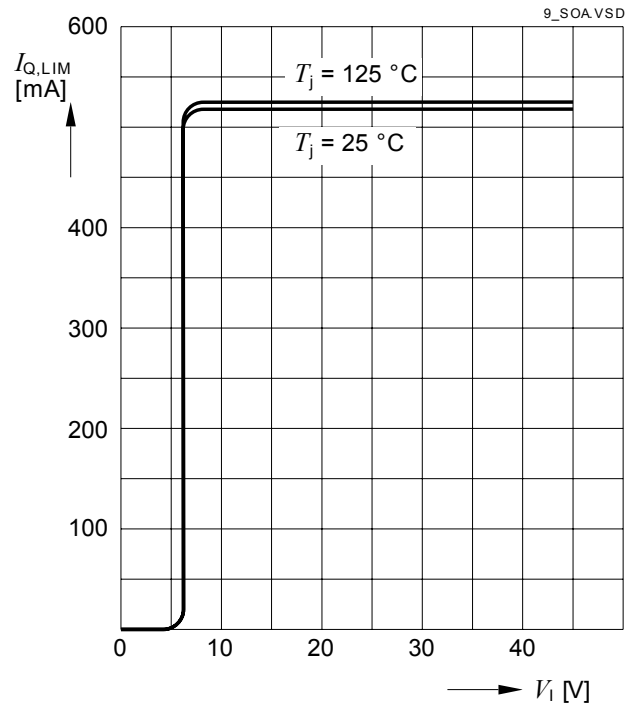

Typical Performance Characteristics

Region of Stability

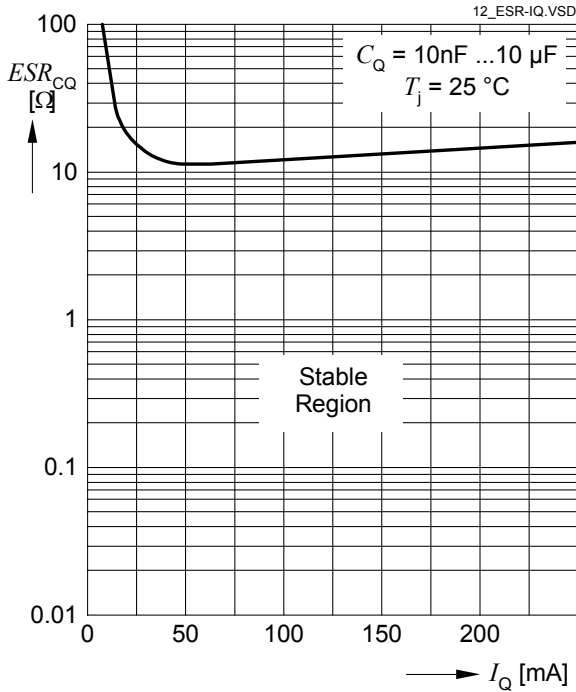

Output Voltage V_Q Start-up behavior

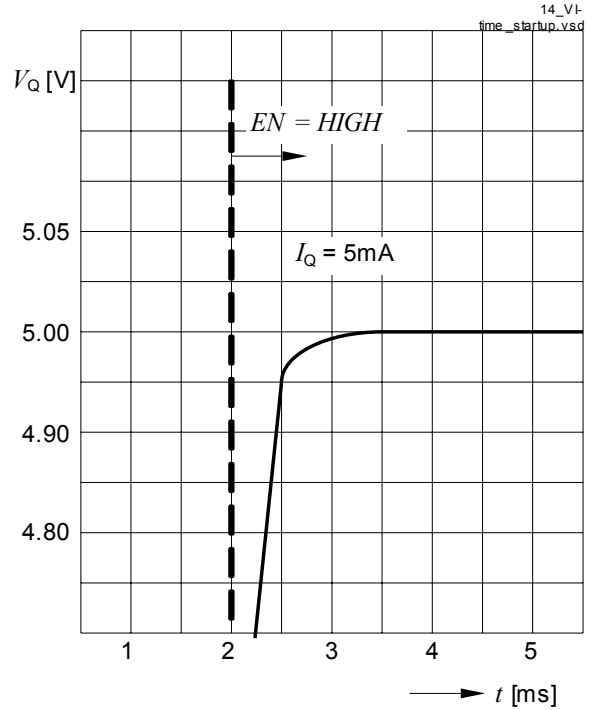

Power Supply Ripple Rejection PSRR versus Frequency f

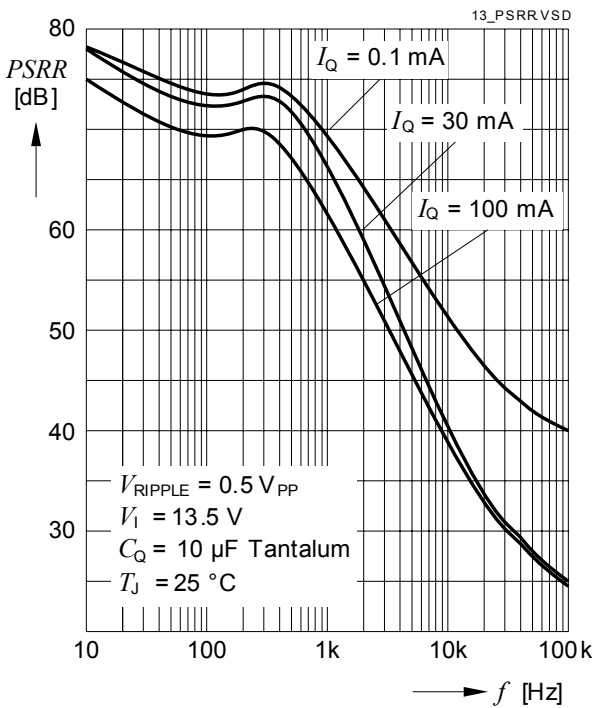

Load Regulation ΔV_Q versus Output Current Change ΔI_Q

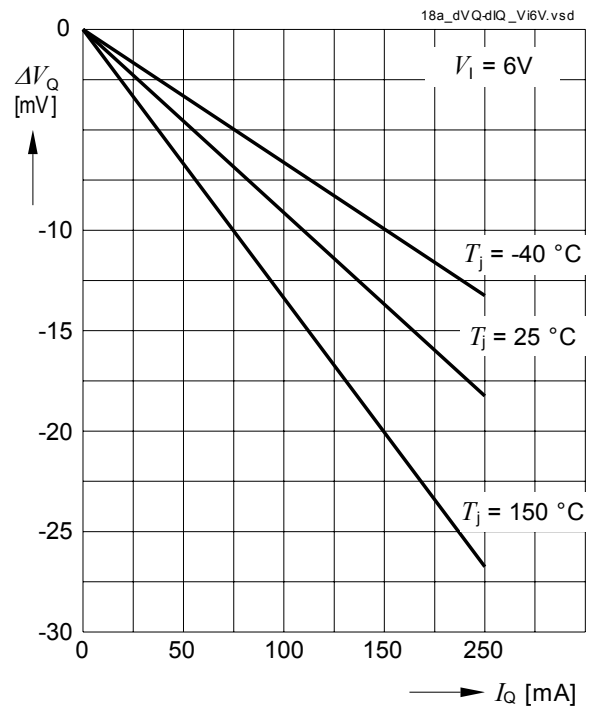

Typical Performance Characteristics

Load Regulation ΔV_Q versus Output Current Change dI_Q

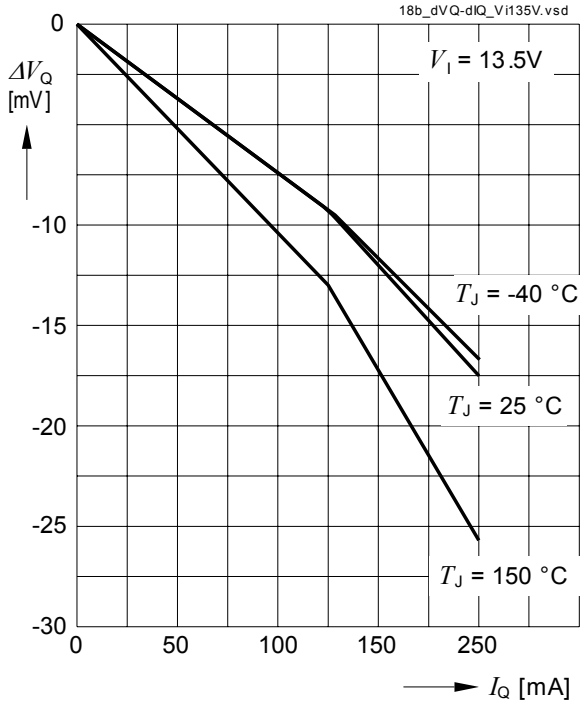

Line Regulation ΔV_Q versus Input Voltage Changed V_1

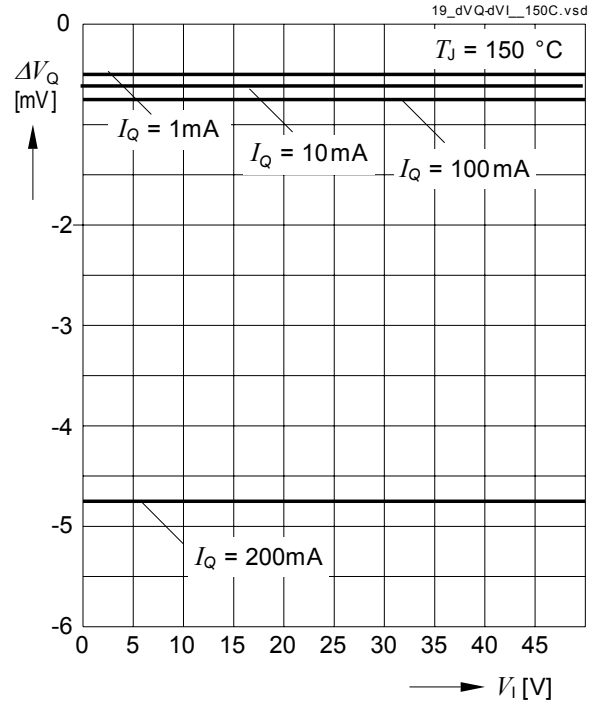

Load Regulation ΔV_Q versus Output Current Change ΔI_Q

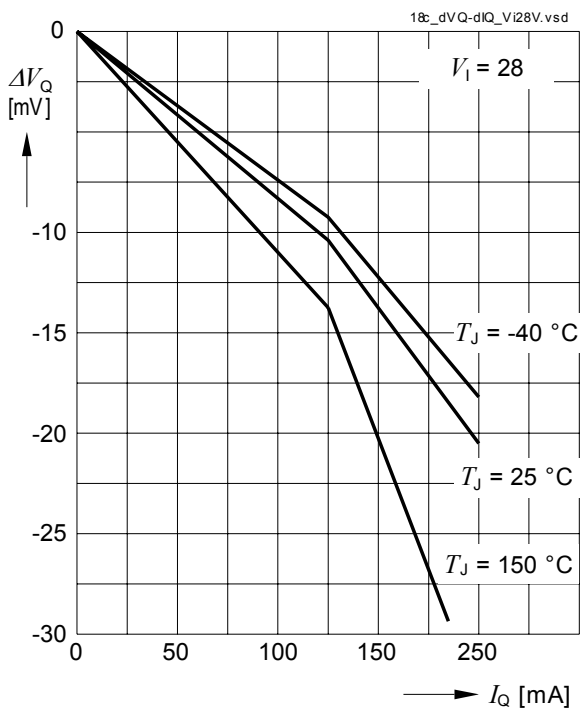

Line Regulation ΔV_Q versus Input Voltage Changed V_1

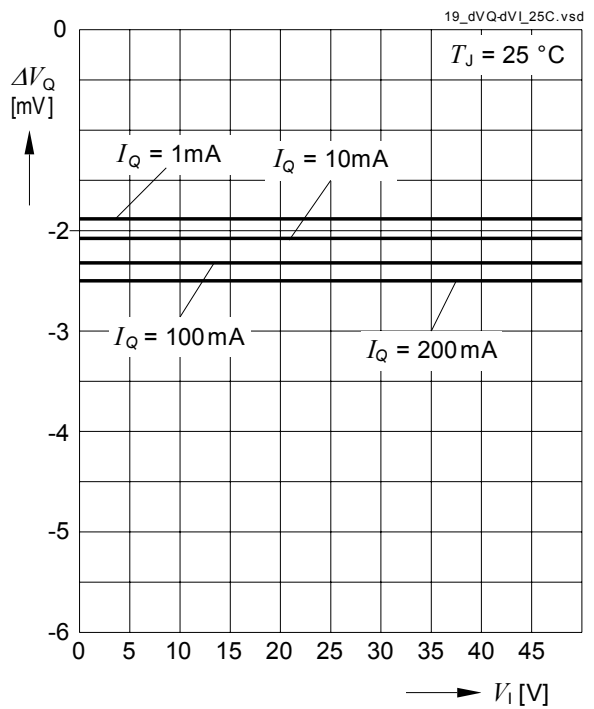

Typical Performance Characteristics

Line Regulation ΔV_Q versus Input Voltage Change V_I

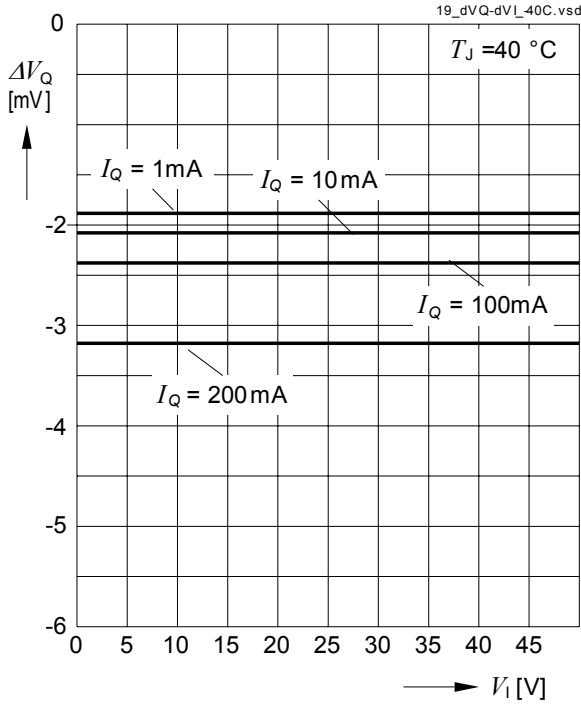

Load Transient Response Peak Voltage ΔV_Q

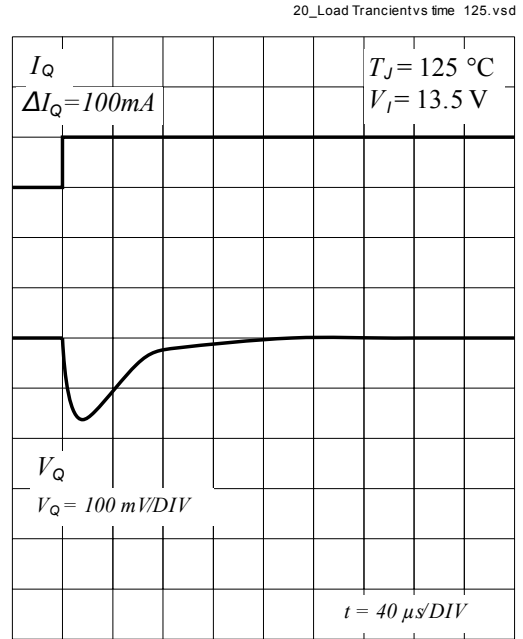

Load Transient Response Peak Voltage ΔV_Q

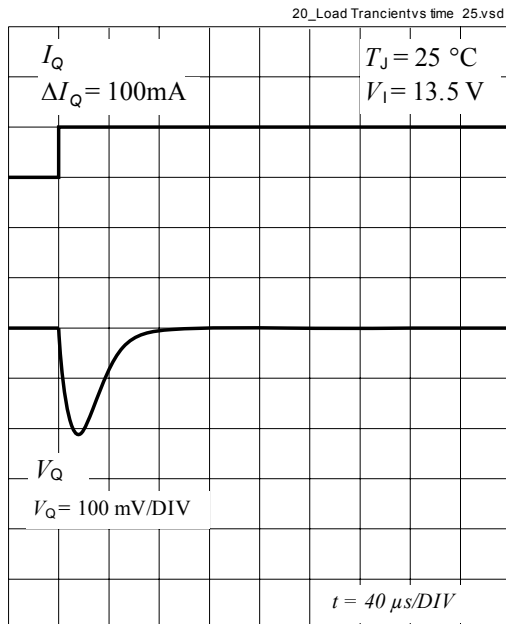

Line Transient Response Peak Voltage ΔV_Q

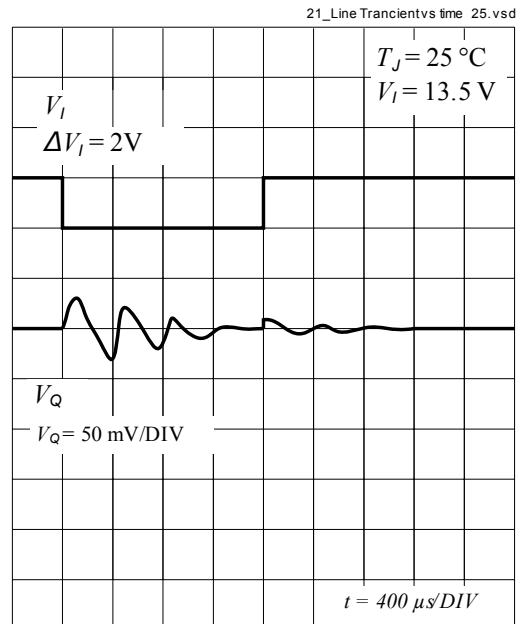

Typical Performance Characteristics

Line Transient Response Peak Voltage ΔV_Q

I

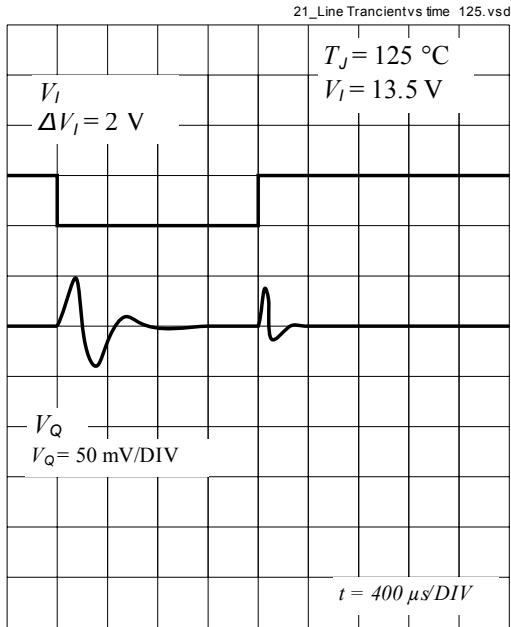

Enabled Input Current I_{EN} versus Input Voltage V_I , EN=Off

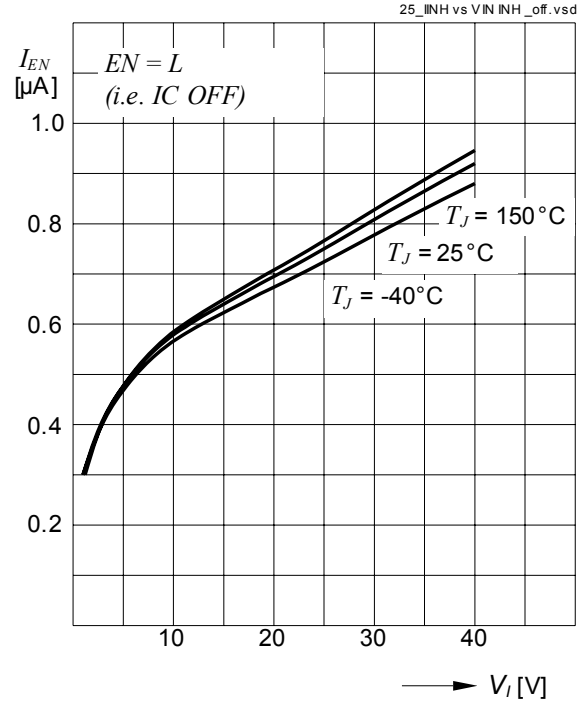

Enabled Input Current I_{EN} versus Enabled Input Voltage V_{EN}

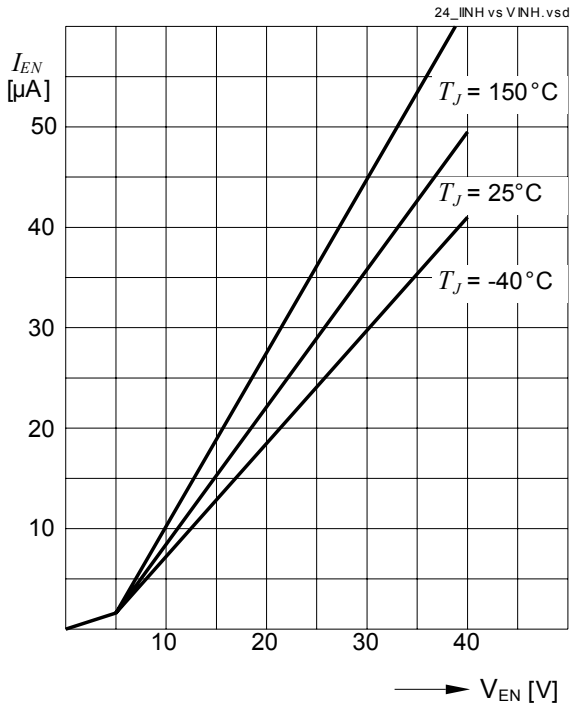

Thermal Resistance Junction-Ambient R_{THJA} versus Power Dissipation P_V

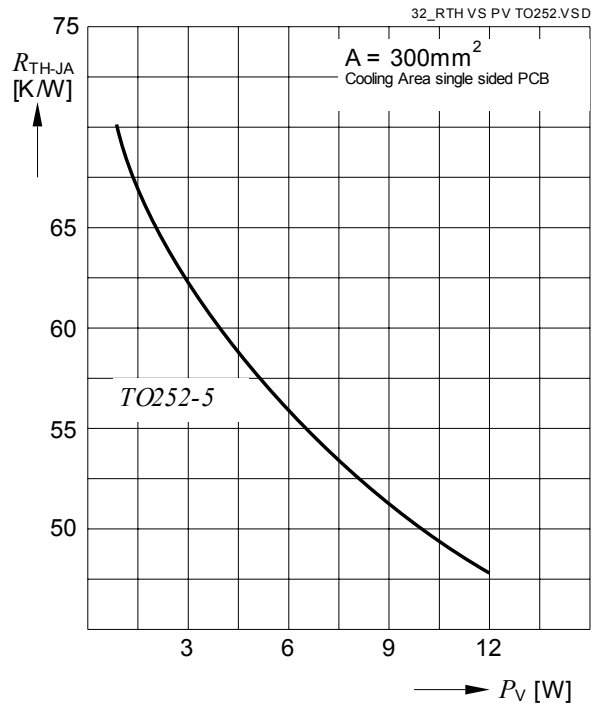

6 Application Information

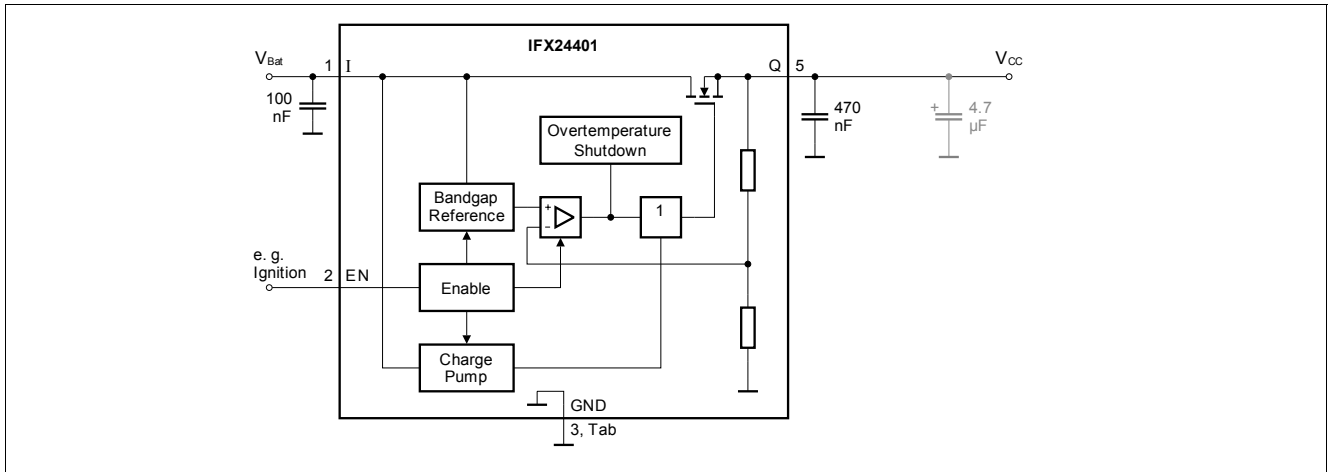

Figure 4 Application Diagram

Input, Output

An input capacitor is necessary for damping line influences. A resistor of approx. 1 Ω in series with C_I, can damp the LC of the input inductivity and the input capacitor.

The IFX24401 requires a ceramic output capacitor of at least 470 nF. In order to damp influences resulting from load current surges it is recommended to add an additional electrolytic capacitor of 4.7 μF to 47 μF at the output as shown in [Figure 4](#).

Additionally a buffer capacitor C_B of > 10μF should be used for the output to suppress influences from load surges to the voltage levels. This one can either be an aluminum electrolytic capacitor or a tantalum capacitor following the application requirements.

A general recommendation is to keep the drop over the equivalent serial resistor (ESR) together with the discharge of the blocking capacitor below the allowed Headroom of the Application to be supplied (e.g. typ. dV_Q = 350mV).

Since the regulator output current roughly rises linearly with time the discharge of the capacitor can be calculated as follows:

$$dV_{C_B} = dI_Q \cdot dt / C_B$$

The drop across the ESR calculates as:

$$dV_{ESR} = dI \cdot ESR$$

To prevent a reset the following relationship must be fulfilled:

$$dV_C + dV_{ESR} < V_{RH} = 350mV$$

Example: Assuming a load current change of dI_Q = 100mA, a blocking capacitor of C_B = 22μF and a typical regulator reaction time under normal operating conditions of dt ~ 25μs and for special dynamic load conditions, such as load step from very low base load, a reaction time of dt ~ 75μs.

$$dV_C = dI_Q \cdot dt / C_B = 100mA \cdot 25\mu s / 22\mu F = 113mV$$

So for the ESR we can allow

$$dV_{ESR} = V_{RH2} - dV_C = 350mV - 113mV = 236mV$$

The permissible ESR becomes:

$$ESR = dV_{ESR} / dI_Q = 236mV / 100mA = 2.36\Omega$$

7 Package Outlines

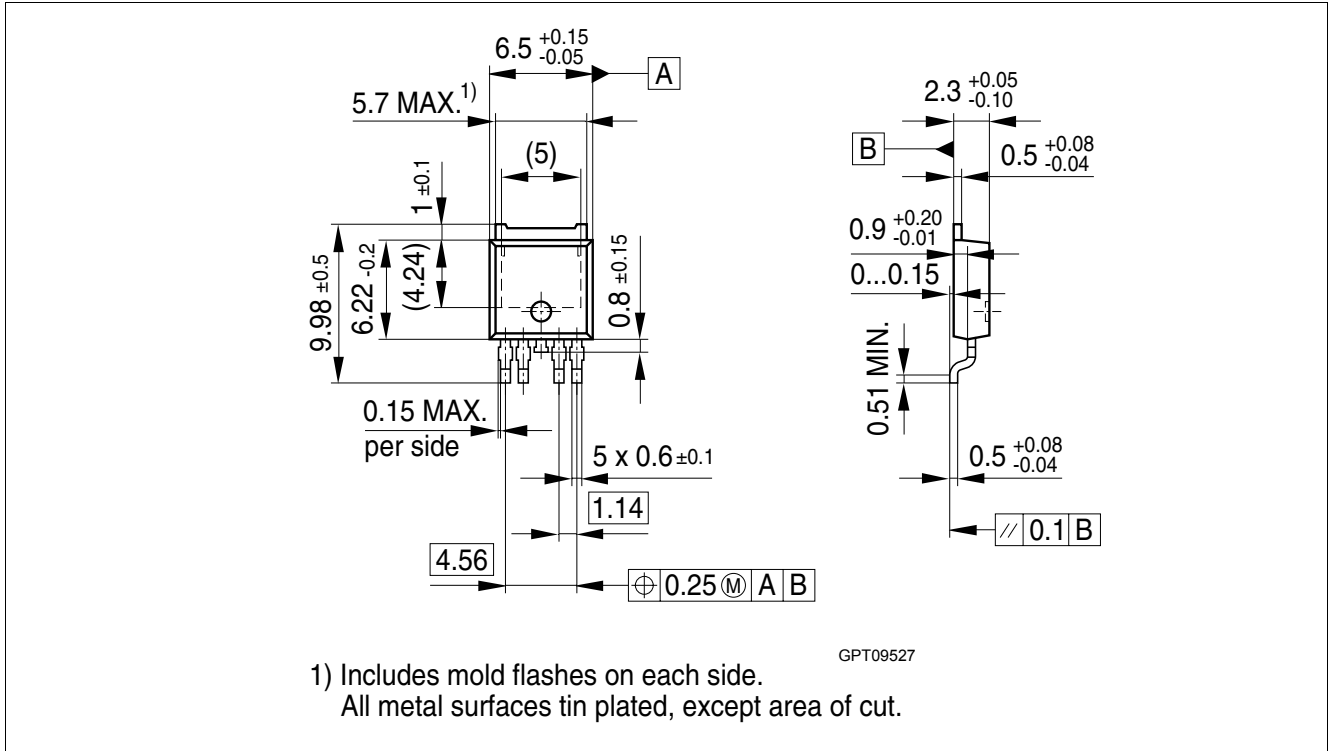

Figure 5 PG-TO252-5

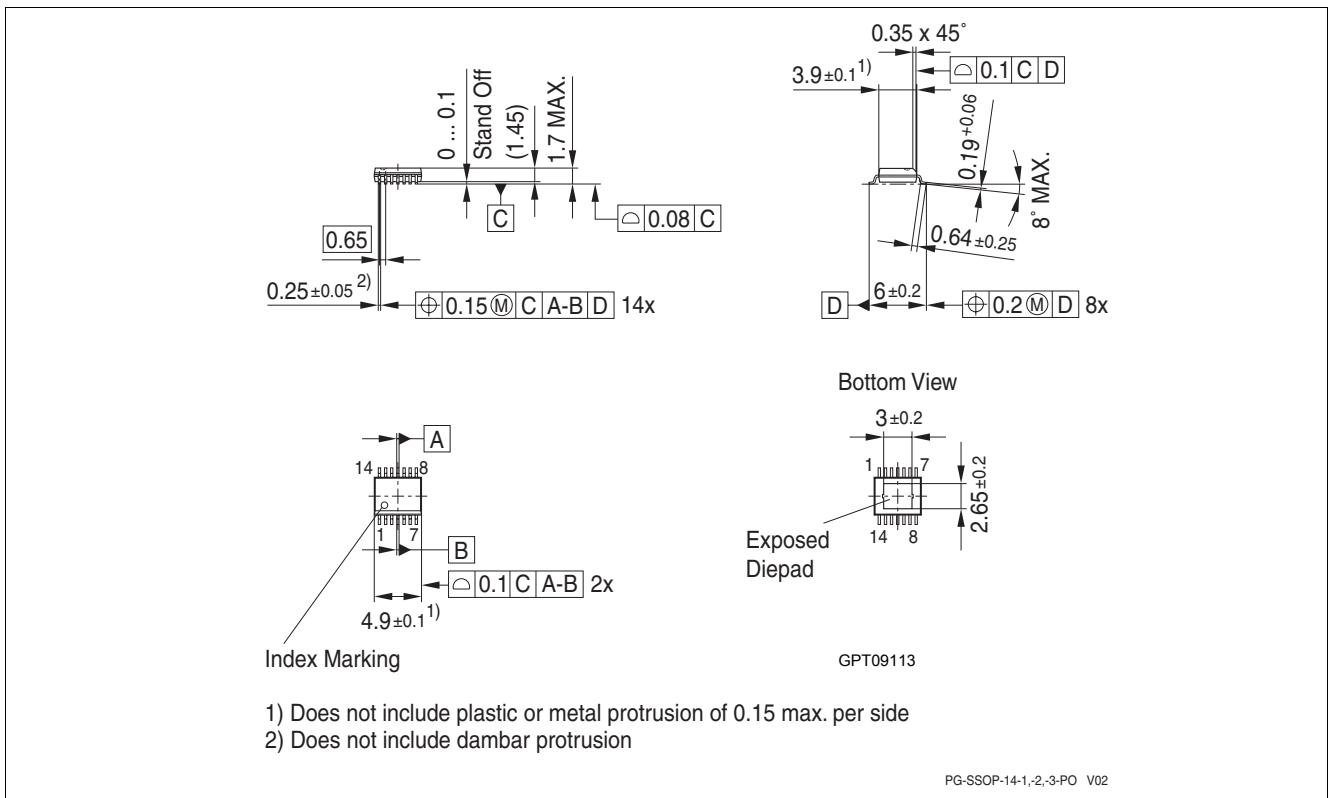

Figure 6 PG-SSOP-14

8 Revision History

Revision	Date	Changes
1.02	2009-12-10	Corrections to pin assignment
1.01	2009-10-19	Coverpage changed Overview page: Inserted reference statement to TLE/TLF series.
1.0	2009-04-28	Initial Release

Edition 2009-12-10

**Published by
Infineon Technologies AG
81726 Munich, Germany**

**© 2009 Infineon Technologies AG
All Rights Reserved.**

Legal Disclaimer

The information given in this document shall in no event be regarded as a guarantee of conditions or characteristics. With respect to any examples or hints given herein, any typical values stated herein and/or any information regarding the application of the device, Infineon Technologies hereby disclaims any and all warranties and liabilities of any kind, including without limitation, warranties of non-infringement of intellectual property rights of any third party.

Information

For further information on technology, delivery terms and conditions and prices, please contact the nearest Infineon Technologies Office (www.infineon.com).

Warnings

Due to technical requirements, components may contain dangerous substances. For information on the types in question, please contact the nearest Infineon Technologies Office.

Infineon Technologies components may be used in life-support devices or systems only with the express written approval of Infineon Technologies, if a failure of such components can reasonably be expected to cause the failure of that life-support device or system or to affect the safety or effectiveness of that device or system. Life support devices or systems are intended to be implanted in the human body or to support and/or maintain and sustain and/or protect human life. If they fail, it is reasonable to assume that the health of the user or other persons may be endangered.

X-ON Electronics

Largest Supplier of Electrical and Electronic Components

Click to view similar products for [LDO Voltage Regulators](#) category:

Click to view products by [Infineon](#) manufacturer:

Other Similar products are found below :

[AP7363-SP-13](#) [L79M05TL-E](#) [PT7M8202B12TA5EX](#) [TCR3DF185,LM\(CT](#) [MP2013GQ-33-Z](#) [059985X](#) [NCP4687DH15T1G](#) [701326R](#)
[TCR2EN28,LF\(S](#) [NCV8170AXV250T2G](#) [TCR2EN18,LF\(S](#) [AP7315-25W5-7](#) [IFX30081LDVGRNXUMA1](#) [NCV47411PAAJR2G](#)
[AP2113KTR-G1](#) [AP2111H-1.2TRG1](#) [ZLDO1117QK50TC](#) [AZ1117IH-1.8TRG1](#) [TCR3DG12,LF](#) [MIC5514-3.3YMT-T5](#) [MIC5512-1.2YMT-](#)
[T5](#) [MIC5317-2.8YM5-T5](#) [SCD7912BTG](#) [NCP154MX180270TAG](#) [SCD33269T-5.0G](#) [NCV8170BMX330TCG](#) [NCV8170AMX120TCG](#)
[NCP706ABMX300TAG](#) [NCP153MX330180TCG](#) [NCP114BMX075TCG](#) [MC33269T-3.5G](#) [CAT6243-ADJCMT5T](#) [TCR3DG33,LF](#)
[AP2127N-1.0TRG1](#) [TCR4DG35,LF](#) [LT1117CST-3.3](#) [LT1117CST-5](#) [TAR5S15U\(TE85L,F\)](#) [TAR5S18U\(TE85L,F\)](#) [TCR3UG19A,LF](#)
[TCR4DG105,LF](#) [NCV8170AMX360TCG](#) [MIC94310-NYMT-T5](#) [TLE4268GSXUMA2](#) [NCV8186BMN175TAG](#) [NCP715SQ15T2G](#)
[MIC5317-3.0YD5-T5](#) [NCV563SQ18T1G](#) [MIC5317-2.8YD5-T5](#) [NCP715MX30TBG](#)