

## Resonant Switching Series

## Reverse conducting IGBT with monolithic body diode

**Features:**

- Powerful monolithic body diode with low forward voltage designed for soft commutation only
- TRENCHSTOP™ technology applications offers:
  - very tight parameter distribution
  - high ruggedness, temperature stable behavior
  - low  $V_{CEsat}$
  - easy parallel switching capability due to positive temperature coefficient in  $V_{CEsat}$
- Low EMI
- Qualified according to JEDEC for target applications
- Pb-free lead plating; RoHS compliant
- Complete product spectrum and PSpice Models:  
<http://www.infineon.com/igbt/>

**Applications:**

- Inductive cooking
- Inverterized microwave ovens
- Resonant converters
- Soft switching applications

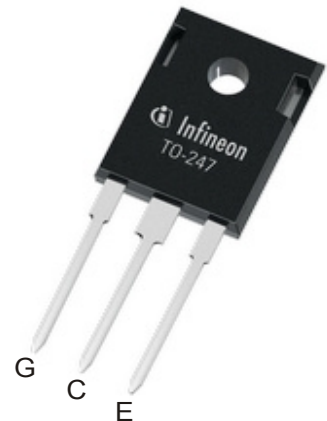
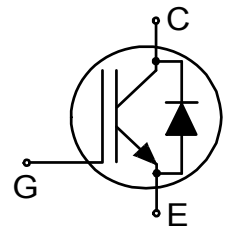
**Key Performance and Package Parameters**

Type	$V_{CE}$	$I_C$	$V_{CEsat}, T_{vj}=25^{\circ}C$	$T_{vjmax}$	Marking	Package
IHW15N120R3	1200V	15A	1.48V	175°C	H15R1203	PG-TO247-3

### Table of Contents

Description .....	1
Table of Contents .....	2
Maximum Ratings .....	3
Thermal Resistance .....	3
Electrical Characteristics .....	4
Electrical Characteristics Diagrams .....	6
Package Drawing .....	12
Testing Conditions .....	13
Revision History .....	14
Disclaimer .....	15

## Resonant Switching Series

## Maximum Ratings

For optimum lifetime and reliability, Infineon recommends operating conditions that do not exceed 80% of the maximum ratings stated in this datasheet.

Parameter	Symbol	Value	Unit
Collector-emitter voltage	$V_{CE}$	1200	V
DC collector current, limited by $T_{vjmax}$ $T_c = 25^\circ\text{C}$ $T_c = 100^\circ\text{C}$	$I_C$	30.0 15.0	A
Pulsed collector current, $t_p$ limited by $T_{vjmax}$	$I_{Cpuls}$	45.0	A
Turn off safe operating area $V_{CE} \leq 1200\text{V}$ , $T_{vj} \leq 175^\circ\text{C}$	-	45.0	A
Diode forward current, limited by $T_{vjmax}$ $T_c = 25^\circ\text{C}$ $T_c = 100^\circ\text{C}$	$I_F$	30.0 15.0	A
Diode pulsed current, $t_p$ limited by $T_{vjmax}$	$I_{Fpuls}$	45.0	A
Gate-emitter voltage Transient Gate-emitter voltage ( $t_p \leq 10\mu\text{s}$ , $D < 0.010$ )	$V_{GE}$	$\pm 20$ $\pm 25$	V
Power dissipation $T_c = 25^\circ\text{C}$ Power dissipation $T_c = 100^\circ\text{C}$	$P_{tot}$	254.0 127.0	W
Operating junction temperature	$T_{vj}$	-40...+175	$^\circ\text{C}$
Storage temperature	$T_{stg}$	-55...+175	$^\circ\text{C}$
Soldering temperature, wave soldering 1.6mm (0.063in.) from case for 10s		260	$^\circ\text{C}$
Mounting torque, M3 screw Maximum of mounting processes: 3	$M$	0.6	Nm

## Thermal Resistance

Parameter	Symbol	Conditions	Value			Unit
			min.	typ.	max.	
<b><math>R_{th}</math> Characteristics</b>						
IGBT thermal resistance, junction - case	$R_{th(j-c)}$		-	-	0.59	K/W
Diode thermal resistance, junction - case	$R_{th(j-c)}$		-	-	0.59	K/W
Thermal resistance junction - ambient	$R_{th(j-a)}$		-	-	40	K/W

## Resonant Switching Series

Electrical Characteristic, at  $T_{vj} = 25^{\circ}\text{C}$ , unless otherwise specified

Parameter	Symbol	Conditions	Value			Unit
			min.	typ.	max.	
<b>Static Characteristic</b>						
Collector-emitter breakdown voltage	$V_{(BR)CES}$	$V_{GE} = 0\text{V}, I_C = 0.50\text{mA}$	1200	-	-	V
Collector-emitter saturation voltage	$V_{CESat}$	$V_{GE} = 15.0\text{V}, I_C = 15.0\text{A}$ $T_{vj} = 25^{\circ}\text{C}$ $T_{vj} = 125^{\circ}\text{C}$ $T_{vj} = 175^{\circ}\text{C}$	-	1.48	1.70	V
			-	1.70	-	
			-	1.80	-	
Diode forward voltage	$V_F$	$V_{GE} = 0\text{V}, I_F = 15.0\text{A}$ $T_{vj} = 25^{\circ}\text{C}$ $T_{vj} = 125^{\circ}\text{C}$ $T_{vj} = 175^{\circ}\text{C}$	-	1.55	1.75	V
			-	1.70	-	
			-	1.80	-	
Gate-emitter threshold voltage	$V_{GE(th)}$	$I_C = 0.40\text{mA}, V_{CE} = V_{GE}$	5.1	5.8	6.4	V
Zero gate voltage collector current	$I_{CES}$	$V_{CE} = 1200\text{V}, V_{GE} = 0\text{V}$ $T_{vj} = 25^{\circ}\text{C}$ $T_{vj} = 175^{\circ}\text{C}$	-	-	100	$\mu\text{A}$
			-	-	2500	
Gate-emitter leakage current	$I_{GES}$	$V_{CE} = 0\text{V}, V_{GE} = 20\text{V}$	-	-	100	nA
Transconductance	$g_{fs}$	$V_{CE} = 20\text{V}, I_C = 15.0\text{A}$	-	13.9	-	S
Integrated gate resistor	$r_G$			none		$\Omega$

Electrical Characteristic, at  $T_{vj} = 25^{\circ}\text{C}$ , unless otherwise specified

Parameter	Symbol	Conditions	Value			Unit
			min.	typ.	max.	
<b>Dynamic Characteristic</b>						
Input capacitance	$C_{ies}$	$V_{CE} = 25\text{V}, V_{GE} = 0\text{V}, f = 1\text{MHz}$	-	1165	-	$\mu\text{F}$
Output capacitance	$C_{oes}$		-	40	-	
Reverse transfer capacitance	$C_{res}$		-	32	-	
Gate charge	$Q_G$	$V_{CC} = 960\text{V}, I_C = 15.0\text{A},$ $V_{GE} = 15\text{V}$	-	165.0	-	nC
Internal emitter inductance measured 5mm (0.197 in.) from case	$L_E$		-	13.0	-	nH

## Switching Characteristic, Inductive Load

Parameter	Symbol	Conditions	Value			Unit
			min.	typ.	max.	
<b>IGBT Characteristic, at <math>T_{vj} = 25^{\circ}\text{C}</math></b>						
Turn-off delay time	$t_{d(off)}$	$T_{vj} = 25^{\circ}\text{C},$ $V_{CC} = 600\text{V}, I_C = 15.0\text{A},$ $V_{GE} = 0.0/15.0\text{V},$ $R_{G(on)} = 14.6\Omega, R_{G(off)} = 14.6\Omega,$ $L\sigma = 180\text{nH}, C\sigma = 39\text{pF}$ $L\sigma, C\sigma$ from Fig. E Energy losses include "tail" and diode reverse recovery.	-	300	-	ns
Fall time	$t_f$		-	46	-	ns
Turn-off energy	$E_{off}$		-	0.70	-	mJ

## Resonant Switching Series

## Switching Characteristic, Inductive Load

Parameter	Symbol	Conditions	Value			Unit
			min.	typ.	max.	
<b>IGBT Characteristic, at <math>T_{vj} = 175^{\circ}\text{C}</math></b>						
Turn-off delay time	$t_{d(off)}$	$T_{vj} = 175^{\circ}\text{C}$ , $V_{CC} = 600\text{V}$ , $I_C = 15.0\text{A}$ , $V_{GE} = 0.0/15.0\text{V}$ , $R_{G(on)} = 14.6\Omega$ , $R_{G(off)} = 14.6\Omega$ , $L_{\sigma} = 180\text{nH}$ , $C_{\sigma} = 39\text{pF}$ $L_{\sigma}$ , $C_{\sigma}$ from Fig. E Energy losses include "tail" and diode reverse recovery.	-	370	-	ns
Fall time	$t_f$		-	90	-	ns
Turn-off energy	$E_{off}$		-	1.25	-	mJ

Resonant Switching Series

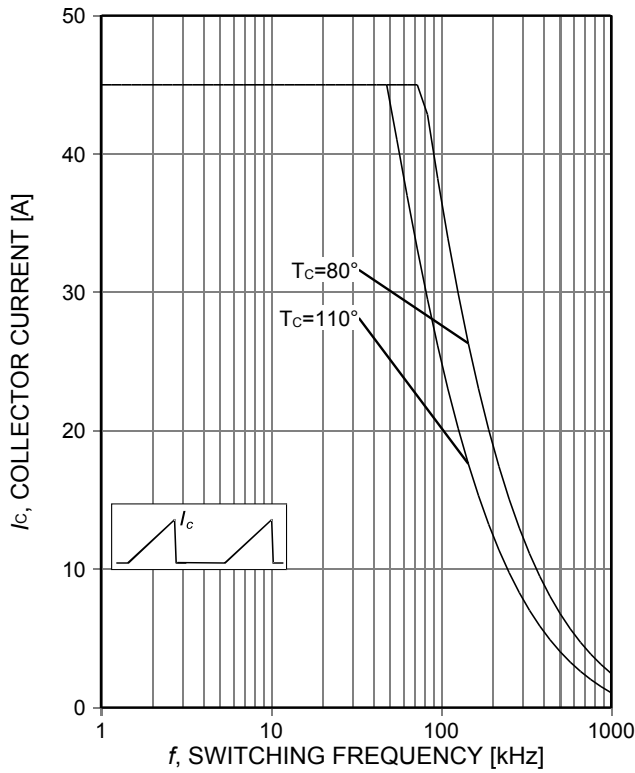

Figure 1. **Collector current as a function of switching frequency**  
 ( $T_j \leq 175^\circ\text{C}$ ,  $D=0.5$ ,  $V_{CE}=600\text{V}$ ,  $V_{GE}=15/0\text{V}$ ,  $R_G=14,6\Omega$ )

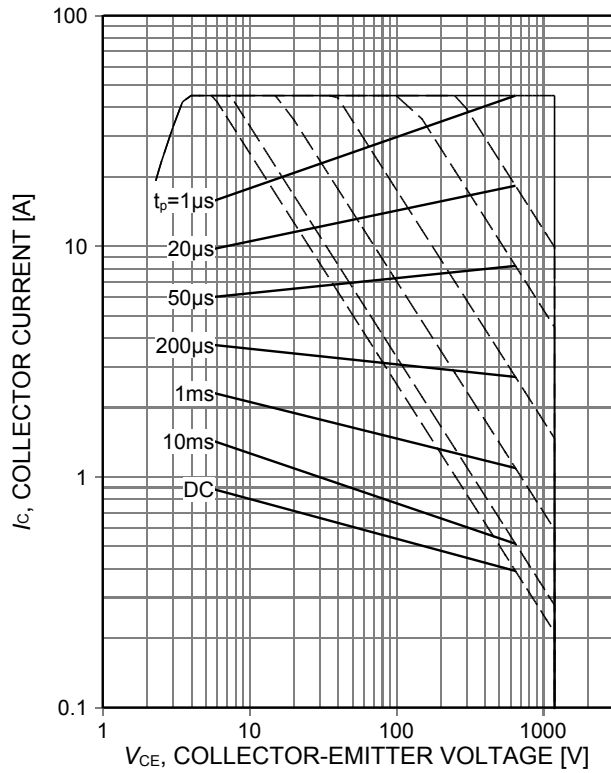

Figure 2. **Forward bias safe operating area**  
 ( $D=0$ ,  $T_C=25^\circ\text{C}$ ,  $T_j \leq 175^\circ\text{C}$ ;  $V_{GE}=15\text{V}$ )

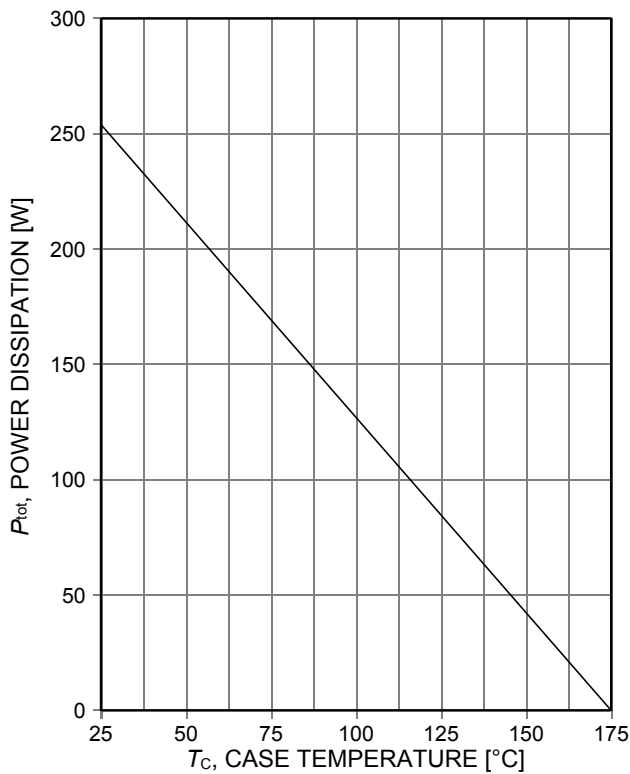

Figure 3. **Power dissipation as a function of case temperature**  
 ( $T_j \leq 175^\circ\text{C}$ )

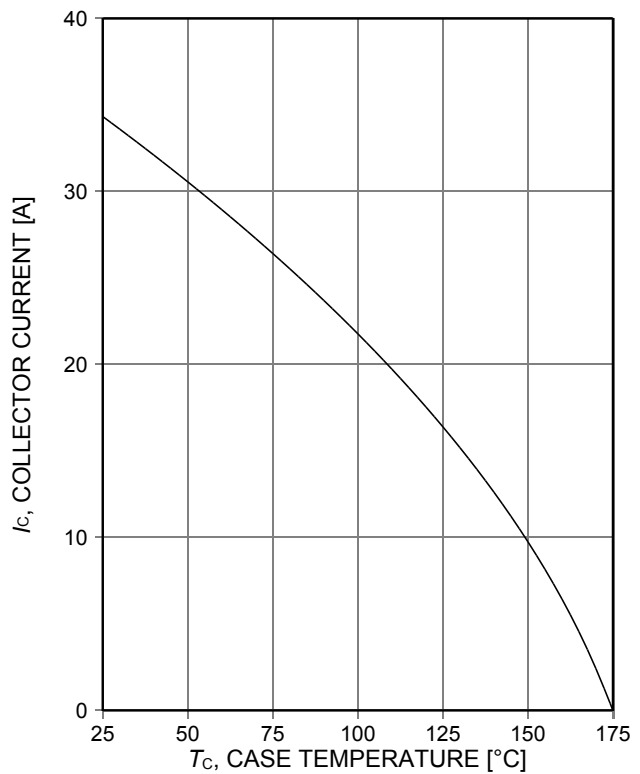

Figure 4. **Collector current as a function of case temperature**  
 ( $V_{GE} \geq 15\text{V}$ ,  $T_j \leq 175^\circ\text{C}$ )

Resonant Switching Series

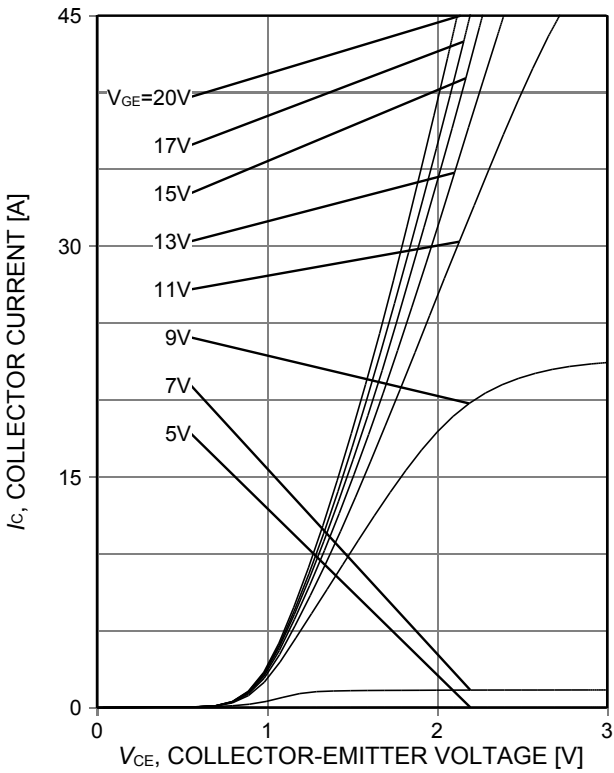

Figure 5. **Typical output characteristic**  
( $T_j=25^{\circ}\text{C}$ )

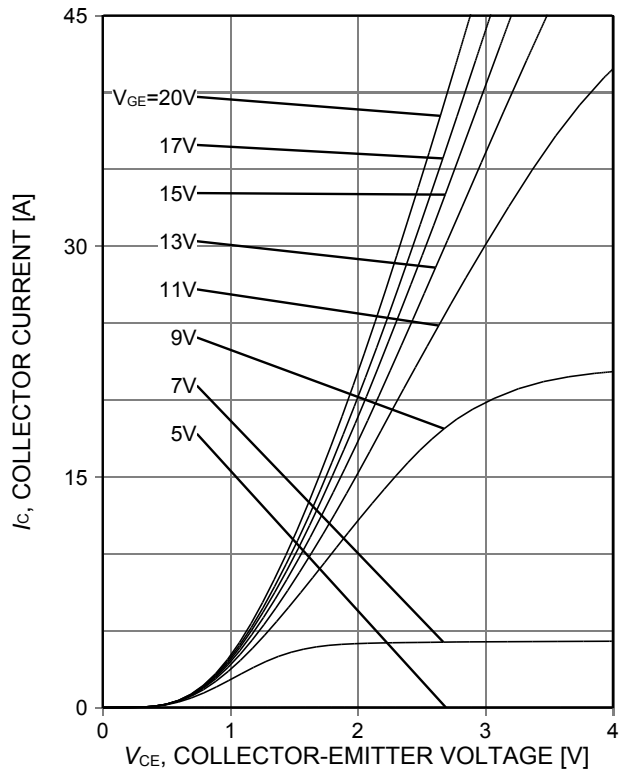

Figure 6. **Typical output characteristic**  
( $T_j=175^{\circ}\text{C}$ )

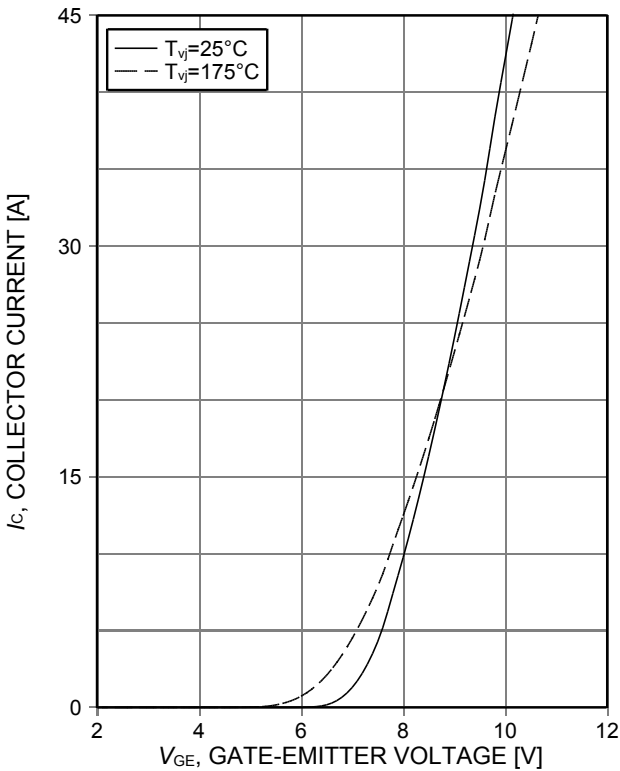

Figure 7. **Typical transfer characteristic**  
( $V_{CE}=20\text{V}$ )

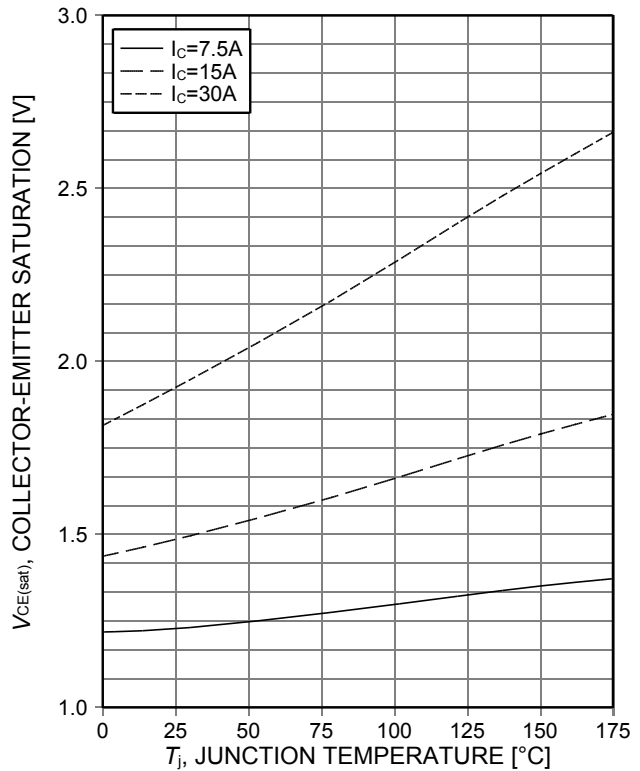

Figure 8. **Typical collector-emitter saturation voltage as a function of junction temperature**  
( $V_{GE}=15\text{V}$ )

Resonant Switching Series

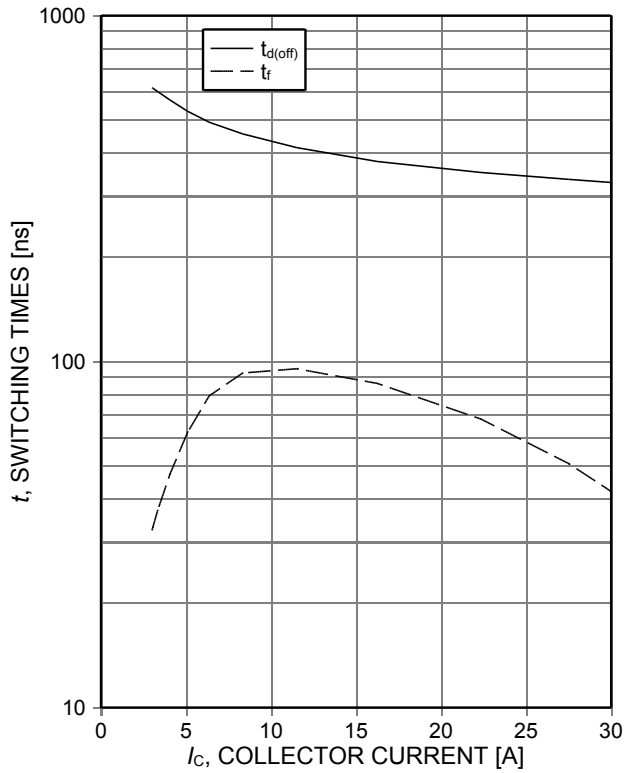

Figure 9. **Typical switching times as a function of collector current**  
 (ind. load,  $T_j=175^\circ\text{C}$ ,  $V_{CE}=600\text{V}$ ,  $V_{GE}=0/15\text{V}$ ,  $R_{G(on)}=14,6\Omega$ ,  $R_{G(off)}=14,6\Omega$ , test circuit in Fig. E)

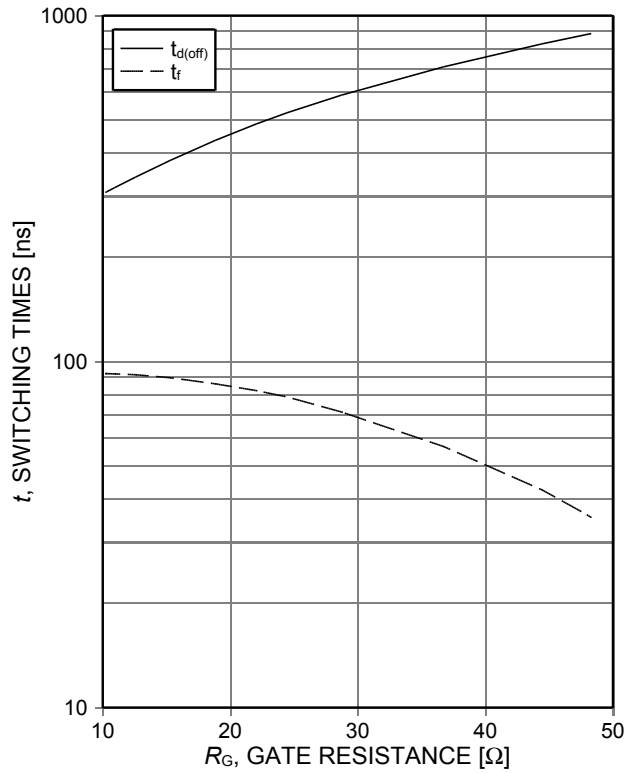

Figure 10. **Typical switching times as a function of gate resistance**  
 (ind. load,  $T_j=175^\circ\text{C}$ ,  $V_{CE}=600\text{V}$ ,  $V_{GE}=0/15\text{V}$ ,  $I_C=15\text{A}$ , test circuit in Fig. E)

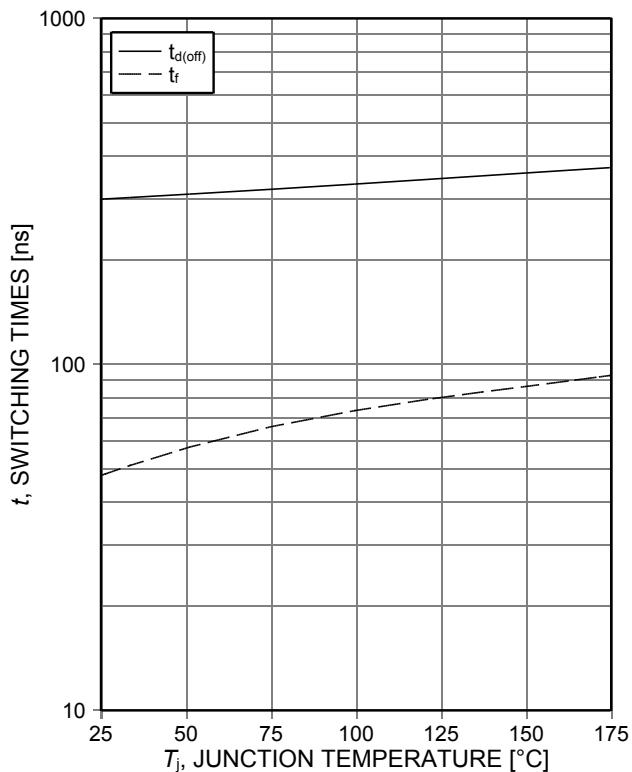

Figure 11. **Typical switching times as a function of junction temperature**  
 (ind. load,  $V_{CE}=600\text{V}$ ,  $V_{GE}=0/15\text{V}$ ,  $I_C=15\text{A}$ ,  $R_{G(on)}=14,6\Omega$ ,  $R_{G(off)}=14,6\Omega$ , test circuit in Fig. E)

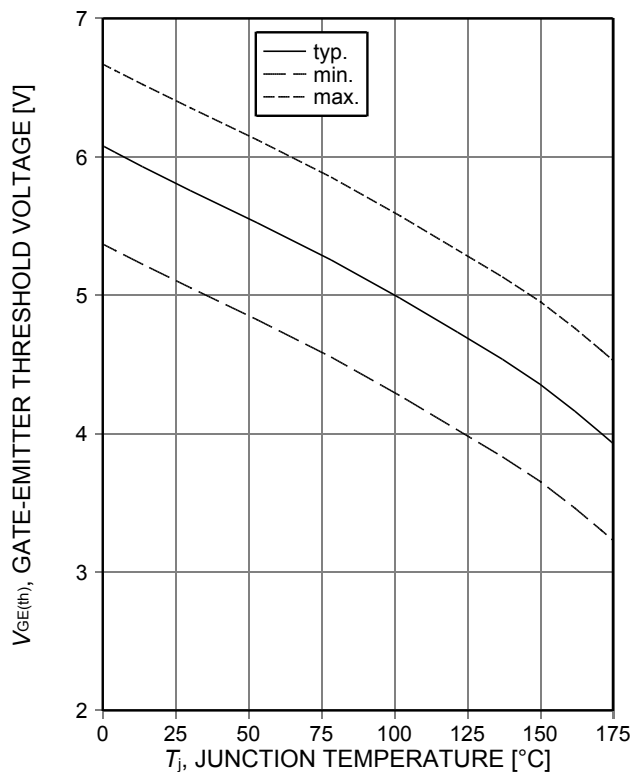

Figure 12. **Gate-emitter threshold voltage as a function of junction temperature**  
 ( $I_C=0.4\text{mA}$ )



Resonant Switching Series

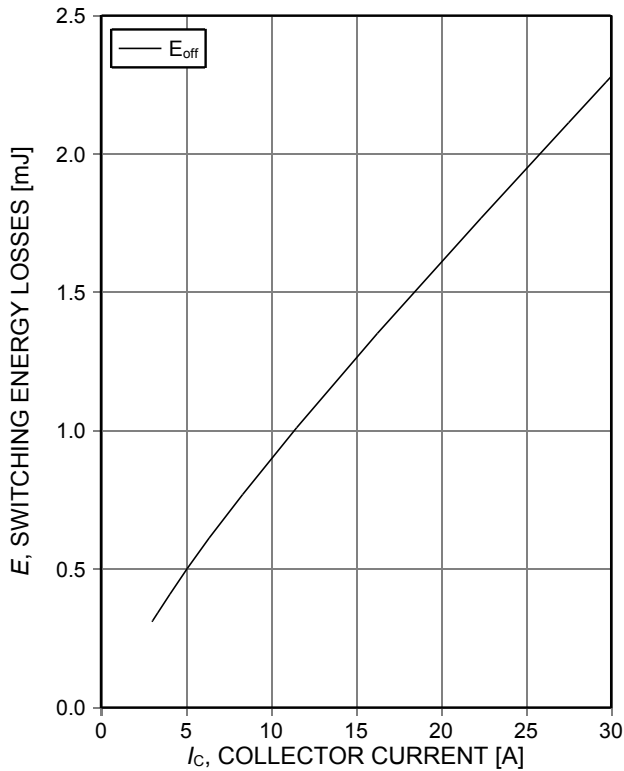

Figure 13. **Typical switching energy losses as a function of collector current**  
 (ind. load,  $T_j=175^\circ\text{C}$ ,  $V_{CE}=600\text{V}$ ,  $V_{GE}=0/15\text{V}$ ,  $R_{G(on)}=14,6\Omega$ ,  $R_{G(off)}=14,6\Omega$ , test circuit in Fig. E)

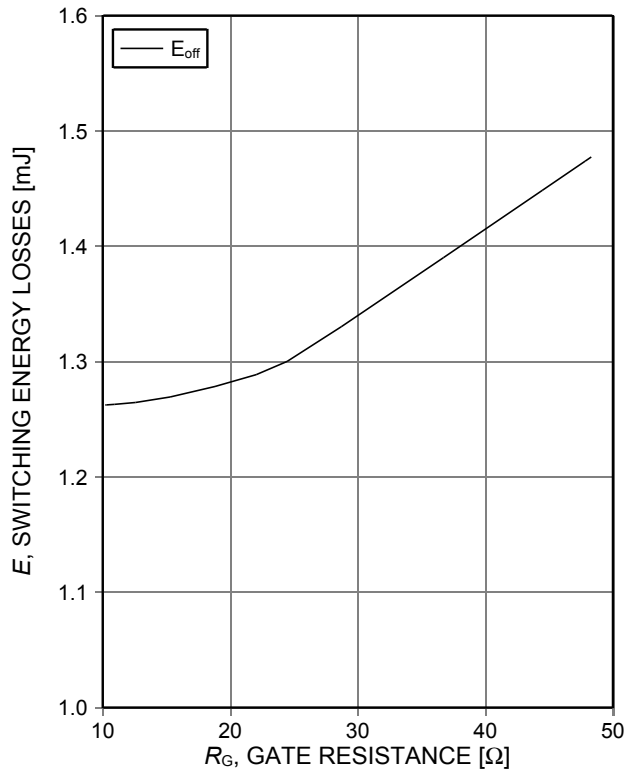

Figure 14. **Typical switching energy losses as a function of gate resistance**  
 (ind. load,  $T_j=175^\circ\text{C}$ ,  $V_{CE}=600\text{V}$ ,  $V_{GE}=0/15\text{V}$ ,  $I_C=15\text{A}$ , test circuit in Fig. E)

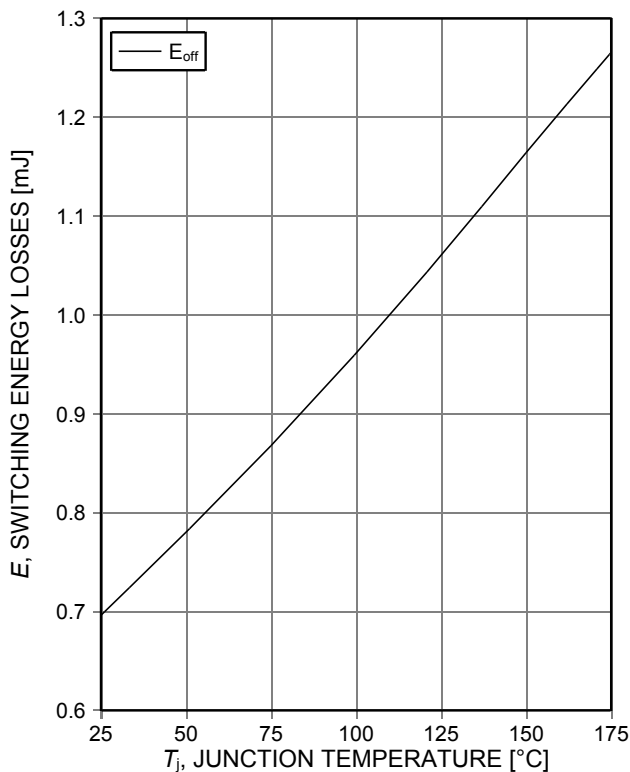

Figure 15. **Typical switching energy losses as a function of junction temperature**  
 (ind load,  $V_{CE}=600\text{V}$ ,  $V_{GE}=0/15\text{V}$ ,  $I_C=15\text{A}$ ,  $R_{G(on)}=14,6\Omega$ ,  $R_{G(off)}=14,6\Omega$ , test circuit in Fig. E)

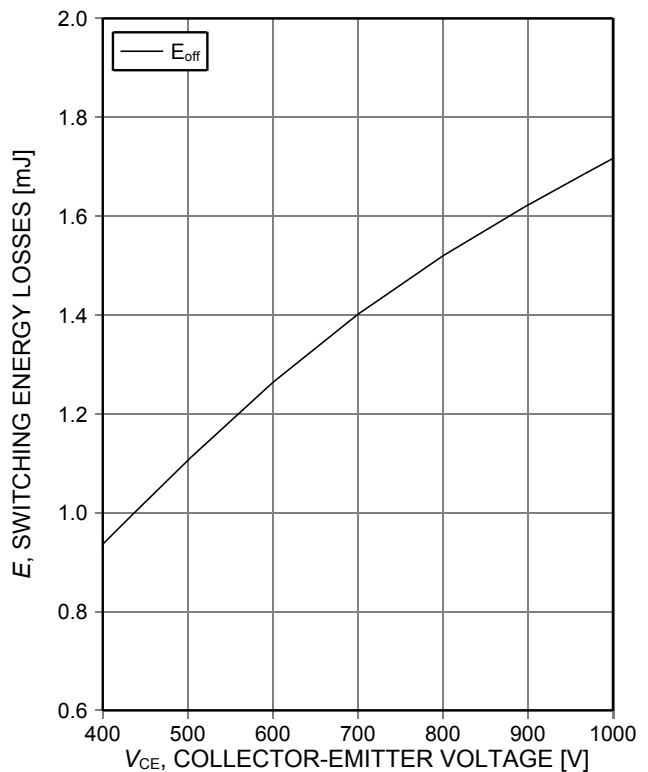

Figure 16. **Typical switching energy losses as a function of collector emitter voltage**  
 (ind. load,  $T_j=175^\circ\text{C}$ ,  $V_{GE}=0/15\text{V}$ ,  $I_C=15\text{A}$ ,  $R_{G(on)}=14,6\Omega$ ,  $R_{G(off)}=14,6\Omega$ , test circuit in Fig. E)

Resonant Switching Series

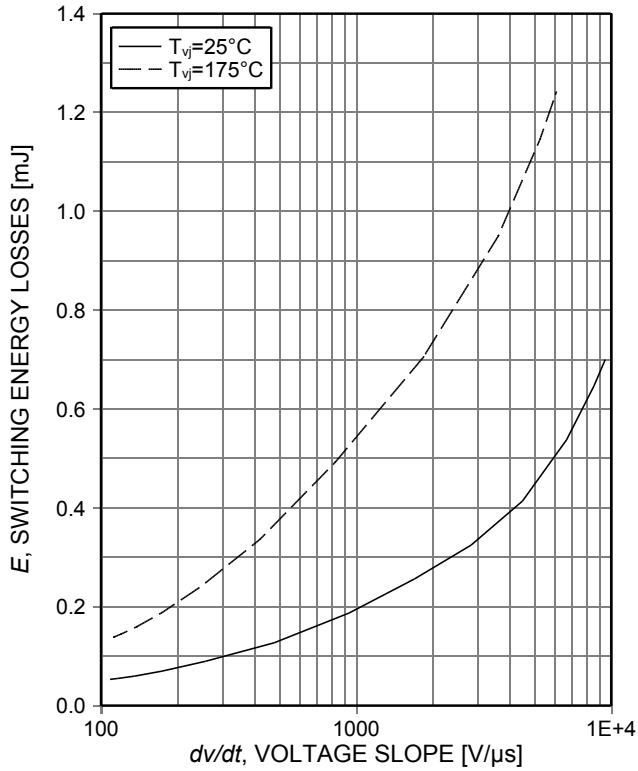

Figure 17. **Typical turn off switching energy loss for soft switching**  
 (ind load,  $V_{CE}=600V$ ,  $V_{GE}=15/0V$ ,  $I_C=15A$ ,  $R_G=14,6\Omega$ , test circuit in Fig. E)

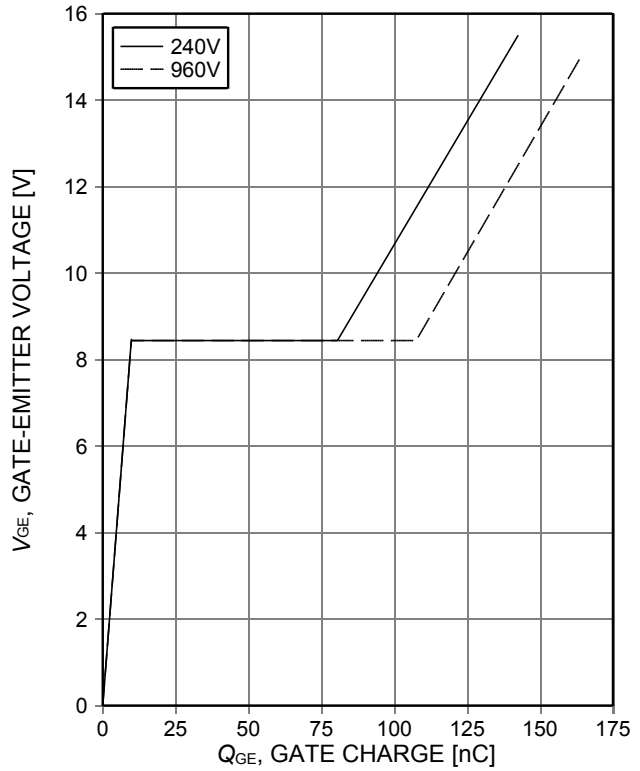

Figure 18. **Typical gate charge**  
 ( $I_C=15A$ )

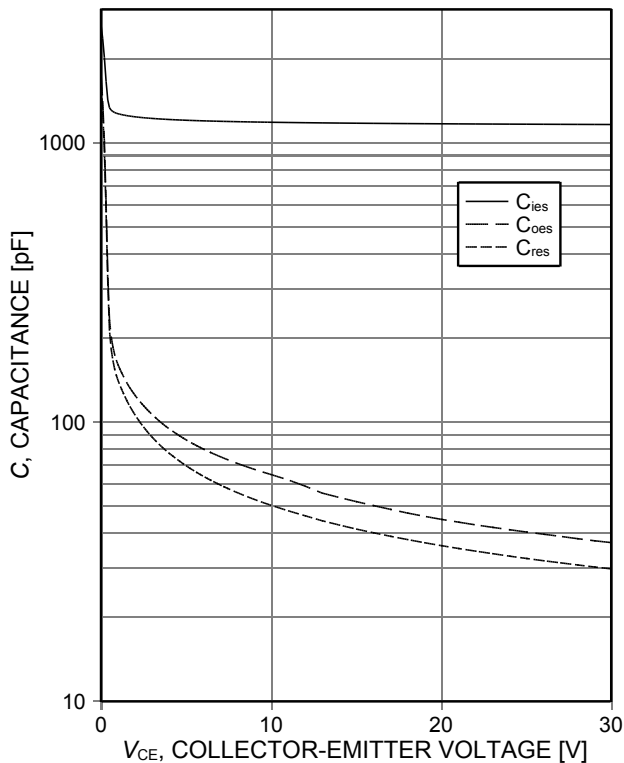

Figure 19. **Typical capacitance as a function of collector-emitter voltage**  
 ( $V_{GE}=0V$ ,  $f=1MHz$ )

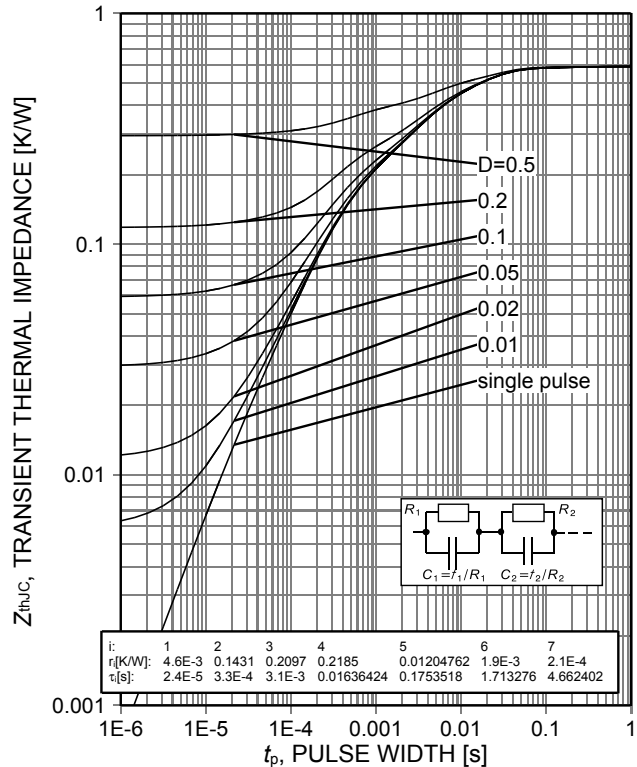

Figure 20. **IGBT transient thermal impedance**  
 ( $D=t_p/T$ )

Resonant Switching Series

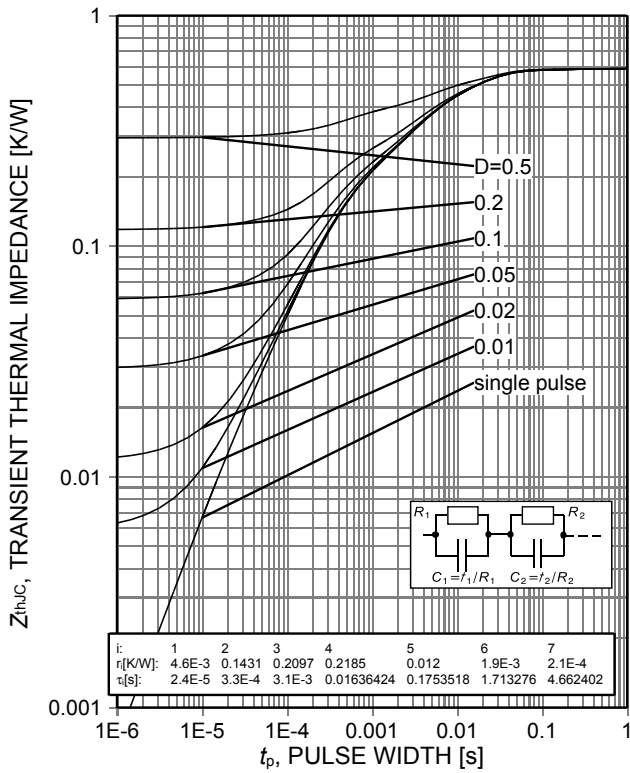

Figure 21. Diode transient thermal impedance as a function of pulse width ( $D = t_p/T$ )

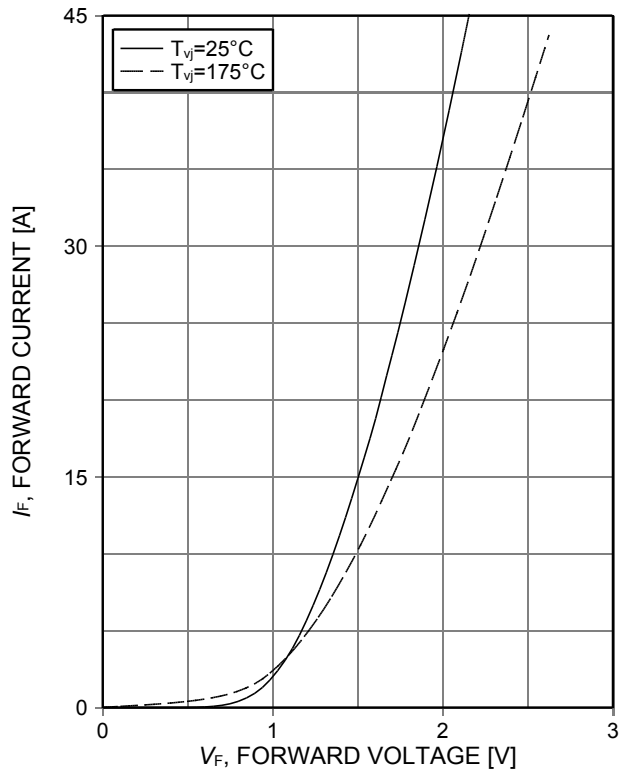

Figure 22. Typical diode forward current as a function of forward voltage

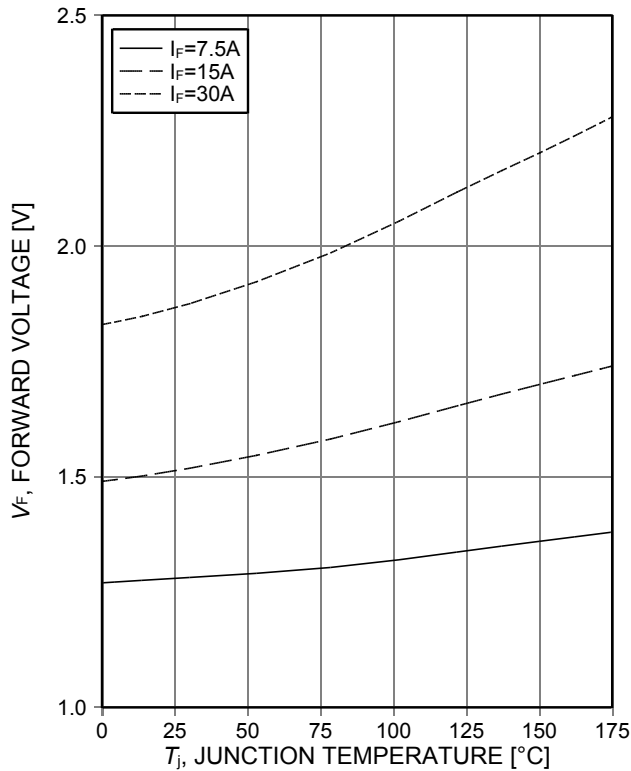
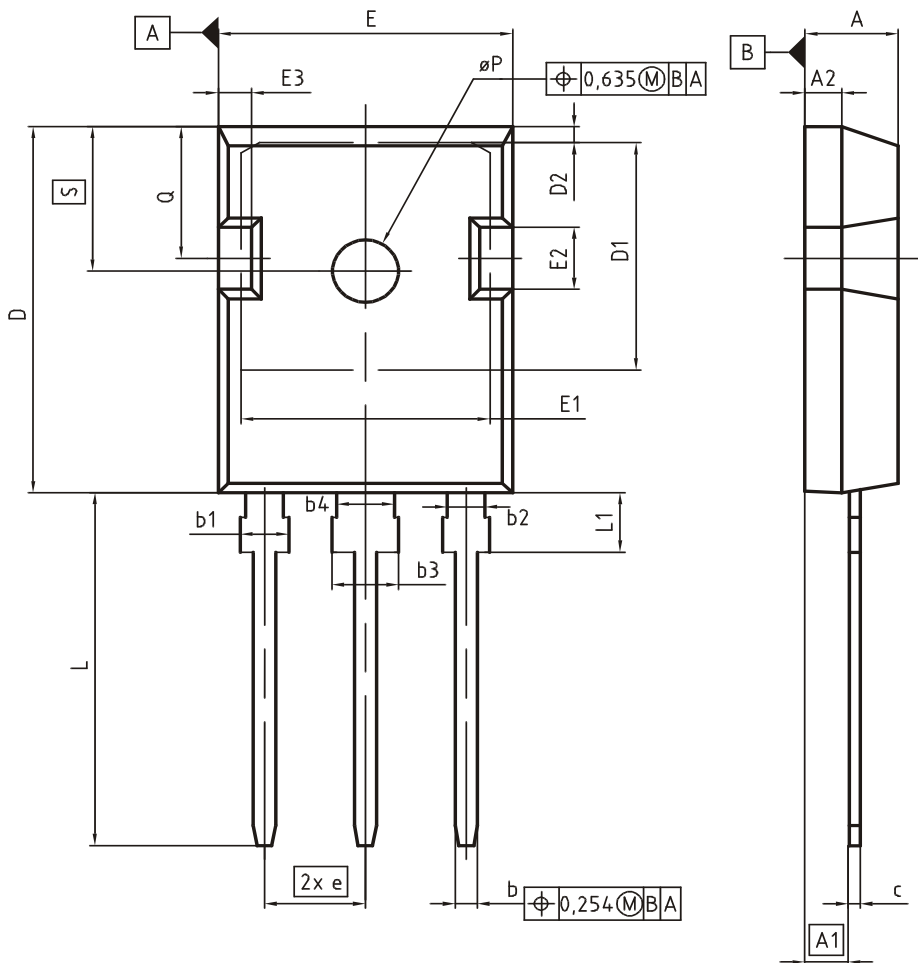

Figure 23. Typical diode forward voltage as a function of junction temperature

### Package Drawing PG-TO247-3



DIM	MILLIMETERS		INCHES	
	MIN	MAX	MIN	MAX
A	4.83	5.21	0.190	0.205
A1	2.27	2.54	0.089	0.100
A2	1.85	2.16	0.073	0.085
b	1.07	1.33	0.042	0.052
b1	1.90	2.41	0.075	0.095
b2	1.90	2.16	0.075	0.085
b3	2.87	3.38	0.113	0.133
b4	2.87	3.13	0.113	0.123
c	0.55	0.68	0.022	0.027
D	20.80	21.10	0.819	0.831
D1	16.25	17.65	0.640	0.695
D2	0.95	1.35	0.037	0.053
E	15.70	16.13	0.618	0.635
E1	13.10	14.15	0.516	0.557
E2	3.68	5.10	0.145	0.201
E3	1.00	2.60	0.039	0.102
e	5.44 (BSC)		0.214 (BSC)	
N	3		3	
L	19.80	20.32	0.780	0.800
L1	4.10	4.47	0.161	0.176
ØP	3.50	3.70	0.138	0.146
Q	5.49	6.00	0.216	0.236
S	6.04	6.30	0.238	0.248

**DOCUMENT NO.**  
Z8B00003327

**SCALE**

**EUROPEAN PROJECTION**

**ISSUE DATE**  
09-07-2010

**REVISION**  
05

Resonant Switching Series

Testing Conditions

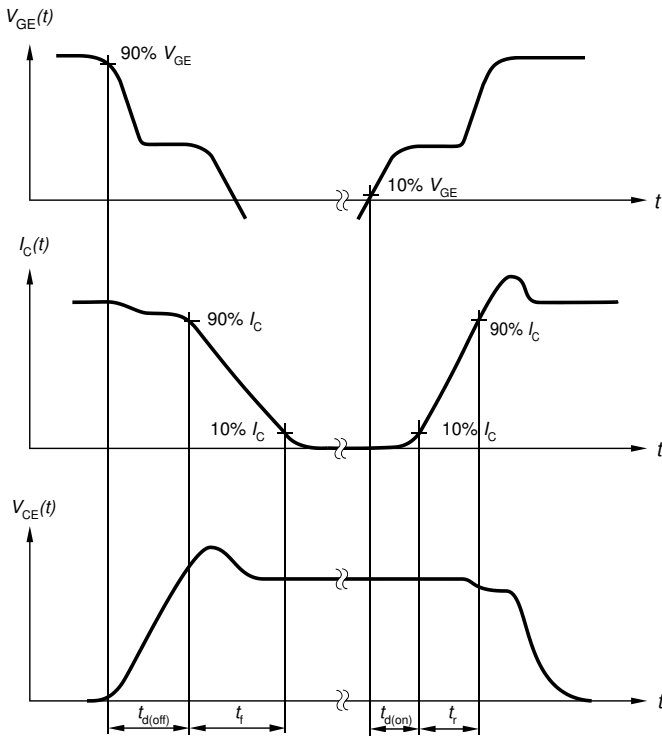

Figure A. Definition of switching times

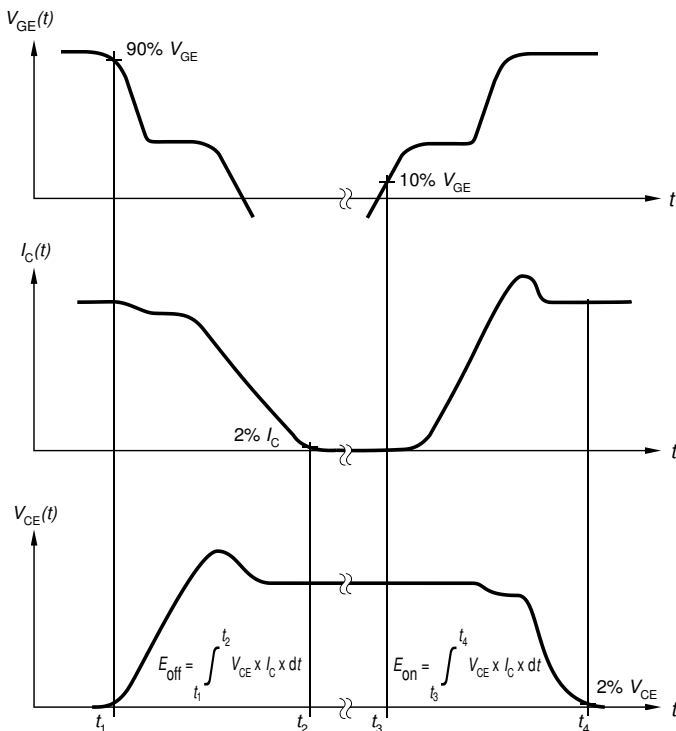

Figure B. Definition of switching losses

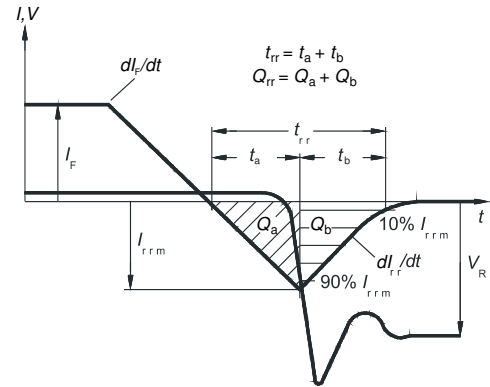

Figure C. Definition of diode switching characteristics

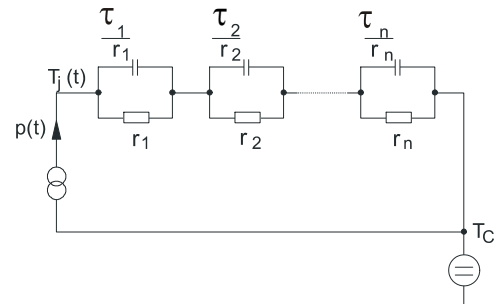

Figure D. Thermal equivalent circuit

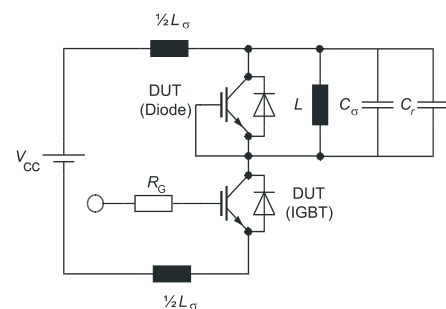

Figure E. Dynamic test circuit  
Parasitic inductance  $L_{\sigma}$ ,  
parasitic capacitor  $C_{\sigma}$ ,  
relief capacitor  $C_r$ ,  
(only for ZVT switching)

---

**Resonant Switching Series****Revision History**

IHW15N120R3

**Revision: 2018-03-29, Rev. 2.5**

Previous Revision

Revision	Date	Subjects (major changes since last revision)
1.1	2009-04-01	-
2.1	2009-05-27	-
2.2	2011-04-05	Pack. draw. rev. 05, marking update
2.3	2013-02-12	Layout change
2.4	2015-01-26	Minor changes
2.5	2018-03-29	Fig.12 and Fig.17 minor change of legend

## Trademarks

All referenced product or service names and trademarks are the property of their respective owners.

**Published by**  
**Infineon Technologies AG**  
**81726 München, Germany**  
**© Infineon Technologies AG 2018.**  
**All Rights Reserved.**

## Important Notice

The information given in this document shall in no event be regarded as a guarantee of conditions or characteristics ("Beschaffenheitsgarantie"). With respect to any examples, hints or any typical values stated herein and/or any information regarding the application of the product, Infineon Technologies hereby disclaims any and all warranties and liabilities of any kind, including without limitation warranties of non-infringement of intellectual property rights of any third party.

In addition, any information given in this document is subject to customer's compliance with its obligations stated in this document and any applicable legal requirements, norms and standards concerning customer's products and any use of the product of Infineon Technologies in customer's applications.

The data contained in this document is exclusively intended for technically trained staff. It is the responsibility of customer's technical departments to evaluate the suitability of the product for the intended application and the completeness of the product information given in this document with respect to such application.

For further information on the product, technology, delivery terms and conditions and prices please contact your nearest Infineon Technologies office ([www.infineon.com](http://www.infineon.com)).

Please note that this product is not qualified according to the AEC Q100 or AEC Q101 documents of the Automotive Electronics Council.

## Warnings

Due to technical requirements products may contain dangerous substances. For information on the types in question please contact your nearest Infineon Technologies office.

Except as otherwise explicitly approved by Infineon Technologies in a written document signed by authorized representatives of Infineon Technologies, Infineon Technologies' products may not be used in any applications where a failure of the product or any consequences of the use thereof can reasonably be expected to result in personal injury.

## X-ON Electronics

Largest Supplier of Electrical and Electronic Components

*Click to view similar products for [IGBT Transistors](#) category:*

*Click to view products by [Infineon](#) manufacturer:*

Other Similar products are found below :

[748152A](#) [APT20GT60BRDQ1G](#) [APT50GT60BRG](#) [NGTB10N60FG](#) [STGFW20V60DF](#) [APT30GP60BG](#) [APT45GR65B2DU30](#)  
[GT50JR22\(STA1ES\)](#) [TIG058E8-TL-H](#) [IGW40N120H3FKSA1](#) [VS-CPV364M4KPBF](#) [NGTB25N120FL2WAG](#) [NGTG40N120FL2WG](#)  
[RJH60F3DPQ-A0#T0](#) [APT40GR120B2SCD10](#) [APT15GT120BRG](#) [APT20GT60BRG](#) [NGTB75N65FL2WAG](#) [NGTG15N120FL2WG](#)  
[IXA30RG1200DHGLB](#) [IXA40RG1200DHGLB](#) [APT70GR65B2DU40](#) [NTE3320](#) [QP12W05S-37A](#) [IHF40N65R5SXXSA1](#) [APT70GR120J](#)  
[APT35GP120JDQ2](#) [XD15H120CX1](#) [XD25H120CX0](#) [XP15PJS120CL1B1](#) [IGW30N60H3FKSA1](#) [STGWA8M120DF3](#) [IGW08T120FKSA1](#)  
[IGW75N60H3FKSA1](#) [FGH60N60SMD\\_F085](#) [FGH75T65UPD](#) [STGWA15H120F2](#) [IKA10N60TXKSA1](#) [IHW20N120R5XKSA1](#)  
[RJH60D2DPP-M0#T2](#) [IKP20N60TXKSA1](#) [IHW20N65R5XKSA1](#) [APT70GR120JD60](#) [AOD5B60D](#) [APT70GR120L](#) [STGWT60H65FB](#)  
[STGWT60H65DFB](#) [STGWT40V60DF](#) [STGWT20V60DF](#) [STGB10NB37LZT4](#)