

Resonant Switching Series

Reverse Conducting IGBT with monolithic body diode

Features:

- Powerful monolithic body diode with low forward voltage designed for soft commutation
- TRENCHSTOP™ technology offering:
 - very tight parameter distribution
 - high ruggedness, temperature stable behavior
 - low V_{CEsat}
 - easy parallel switching capability due to positive temperature coefficient in V_{CEsat}
- Low EMI
- Qualified according to JESD-022 for target applications
- Pb-free lead plating; RoHS compliant
- Halogen free (according to IEC 61249-2-21)
- Complete product spectrum and PSpice Models:
<http://www.infineon.com/igbt/>

Applications:

- Induction cooking
- Microwave ovens

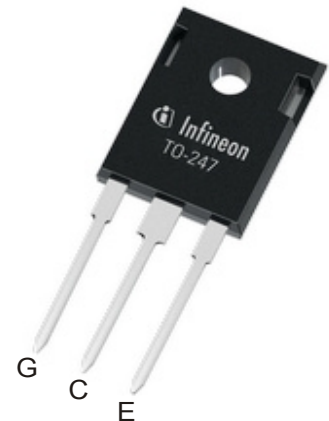
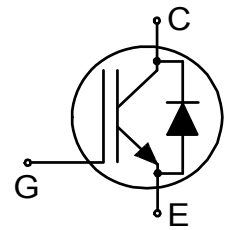

Key Performance and Package Parameters

Type	V_{CE}	I_C	$V_{CEsat}, T_{vj}=25^{\circ}C$	T_{vjmax}	Marking	Package
IHW30N135R5	1350V	30A	1.65V	175°C	H30PR5	PG-TO247-3

Table of Contents

Description	1
Table of Contents	2
Maximum Ratings	3
Thermal Resistance	3
Electrical Characteristics	4
Electrical Characteristics Diagrams	6
Package Drawing	12
Testing Conditions	13
Revision History	14
Disclaimer	15

Resonant Switching Series

Maximum Ratings

For optimum lifetime and reliability, Infineon recommends operating conditions that do not exceed 80% of the maximum ratings stated in this datasheet.

Parameter	Symbol	Value	Unit
Collector-emitter voltage, $T_{vj} \geq 25^{\circ}\text{C}$	V_{CE}	1350	V
DC collector current, limited by T_{vjmax} $T_c = 25^{\circ}\text{C}$ $T_c = 100^{\circ}\text{C}$	I_C	60.0 30.0	A
Pulsed collector current, t_p limited by T_{vjmax}	I_{Cpuls}	90.0	A
Non repetitive peak collector current ¹⁾	I_{CSM}	200	A
Turn off safe operating area $V_{CE} \leq 1350\text{V}$, $T_{vj} \leq 175^{\circ}\text{C}$, $t_p = 1\mu\text{s}$	-	90.0	A
Diode forward current, limited by T_{vjmax} $T_c = 25^{\circ}\text{C}$ $T_c = 100^{\circ}\text{C}$	I_F	60.0 30.0	A
Diode pulsed current, t_p limited by T_{vjmax}	I_{Fpuls}	90.0	A
Gate-emitter voltage Transient Gate-emitter voltage ($t_p \leq 10\mu\text{s}$, $D < 0.010$)	V_{GE}	± 20 ± 25	V
Power dissipation $T_c = 25^{\circ}\text{C}$ Power dissipation $T_c = 100^{\circ}\text{C}$	P_{tot}	330.0 165.0	W
Operating junction temperature	T_{vj}	-40...+175	$^{\circ}\text{C}$
Storage temperature	T_{stg}	-55...+150	$^{\circ}\text{C}$
Soldering temperature, wave soldering 1.6mm (0.063in.) from case for 10s		260	$^{\circ}\text{C}$
Mounting torque, M3 screw Maximum of mounting processes: 3	M	0.6	Nm

Thermal Resistance

Parameter	Symbol	Conditions	Value			Unit
			min.	typ.	max.	
R_{th} Characteristics						
IGBT thermal resistance, junction - case	$R_{th(j-c)}$		-	-	0.45	K/W
Diode thermal resistance, junction - case	$R_{th(j-c)}$		-	-	0.45	K/W
Thermal resistance junction - ambient	$R_{th(j-a)}$		-	-	40	K/W

¹⁾ capacitor charging saturation current limited by $T_{vjmax} < 175^{\circ}\text{C}$ and $t_p < 3\mu\text{s}$

Resonant Switching Series

Electrical Characteristic, at $T_{vj} = 25^{\circ}\text{C}$, unless otherwise specified

Parameter	Symbol	Conditions	Value			Unit
			min.	typ.	max.	
Static Characteristic						
Collector-emitter breakdown voltage	$V_{(BR)CES}$	$V_{GE} = 0\text{V}, I_C = 0.50\text{mA}$	1350	-	-	V
Collector-emitter saturation voltage	V_{CESat}	$V_{GE} = 15.0\text{V}, I_C = 30.0\text{A}$	-	1.65	1.95	V
		$T_{vj} = 25^{\circ}\text{C}$	-	1.95	-	
		$T_{vj} = 125^{\circ}\text{C}$	-	2.05	-	
Diode forward voltage	V_F	$V_{GE} = 0\text{V}, I_F = 30.0\text{A}$	-	1.85	2.05	V
		$T_{vj} = 25^{\circ}\text{C}$	-	2.10	-	
		$T_{vj} = 175^{\circ}\text{C}$	-	2.25	-	
Gate-emitter threshold voltage	$V_{GE(th)}$	$I_C = 0.75\text{mA}, V_{CE} = V_{GE}$	5.1	5.8	6.4	V
Zero gate voltage collector current	I_{CES}	$V_{CE} = 1350\text{V}, V_{GE} = 0\text{V}$	-	-	100	μA
		$T_{vj} = 25^{\circ}\text{C}$	-	630	-	
Gate-emitter leakage current	I_{GES}	$V_{CE} = 0\text{V}, V_{GE} = 20\text{V}$	-	-	100	nA
		$T_{vj} = 175^{\circ}\text{C}$	-	-	-	
Transconductance	g_{fs}	$V_{CE} = 20\text{V}, I_C = 30.0\text{A}$	-	23.0	-	S
Integrated gate resistor	r_G			none		Ω

Electrical Characteristic, at $T_{vj} = 25^{\circ}\text{C}$, unless otherwise specified

Parameter	Symbol	Conditions	Value			Unit
			min.	typ.	max.	
Dynamic Characteristic						
Input capacitance	C_{ies}	$V_{CE} = 25\text{V}, V_{GE} = 0\text{V}, f = 1\text{MHz}$	-	1810	-	pF
Output capacitance	C_{oes}		-	50	-	
Reverse transfer capacitance	C_{res}		-	40	-	
Gate charge	Q_G	$V_{CC} = 1080\text{V}, I_C = 30.0\text{A}, V_{GE} = 15\text{V}$	-	235.0	-	nC
Internal emitter inductance measured 5mm (0.197 in.) from case	L_E		-	13.0	-	nH

Switching Characteristic, Inductive Load

Parameter	Symbol	Conditions	Value			Unit
			min.	typ.	max.	
IGBT Characteristic, at $T_{vj} = 25^{\circ}\text{C}$						
Turn-off delay time	$t_{d(off)}$	$T_{vj} = 25^{\circ}\text{C}, V_{CC} = 600\text{V}, I_C = 30.0\text{A}, V_{GE} = 0.0/15.0\text{V}, R_{G(on)} = 10.0\Omega, R_{G(off)} = 10.0\Omega, L_{\sigma} = 175\text{nH}, C_{\sigma} = 40\text{pF}$ L_{σ}, C_{σ} from Fig. E Energy losses include "tail" and diode reverse recovery.	-	310	-	ns
Fall time	t_f		-	120	-	ns
Turn-off energy	E_{off}		-	1.40	-	mJ
Turn-off energy, soft switching	E_{off}		$dv/dt = 200.0\text{V}/\mu\text{s}$	-	0.17	-

Resonant Switching Series

Switching Characteristic, Inductive Load

Parameter	Symbol	Conditions	Value			Unit
			min.	typ.	max.	
IGBT Characteristic, at $T_{vj} = 175^{\circ}\text{C}$						
Turn-off delay time	$t_{d(off)}$	$T_{vj} = 175^{\circ}\text{C}$, $V_{CC} = 600\text{V}$, $I_C = 30.0\text{A}$, $V_{GE} = 0.0/15.0\text{V}$, $R_{G(on)} = 10.0\Omega$, $R_{G(off)} = 10.0\Omega$, $L_{\sigma} = 175\text{nH}$, $C_{\sigma} = 40\text{pF}$ L_{σ} , C_{σ} from Fig. E Energy losses include "tail" and diode reverse recovery.	-	385	-	ns
Fall time	t_f		-	295	-	ns
Turn-off energy	E_{off}		-	2.70	-	mJ
Turn-off energy, soft switching	E_{off}	$dv/dt = 200.0\text{V}/\mu\text{s}$	-	0.57	-	mJ

Resonant Switching Series

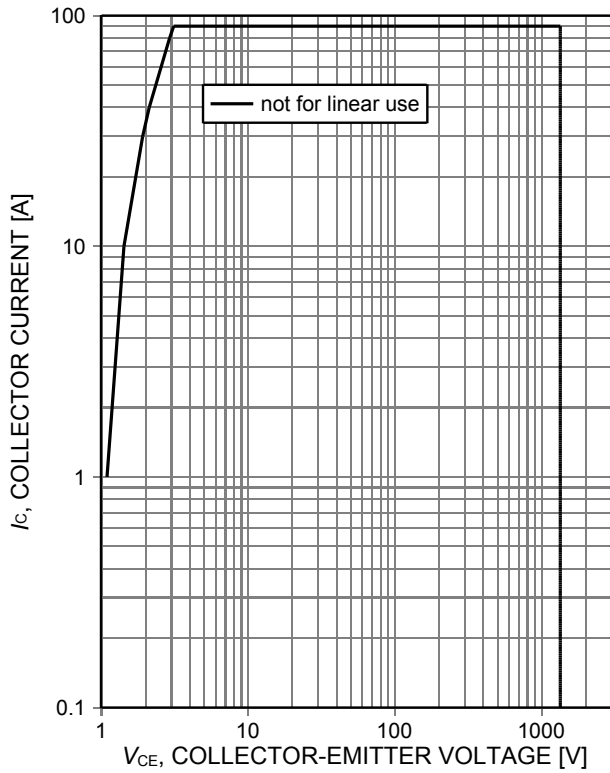

Figure 1. **Forward bias safe operating area**
 ($D=0$, $T_C=25^\circ\text{C}$, $T_{vj}\leq 175^\circ\text{C}$; $V_{GE}=15\text{V}$; $t_p=1\mu\text{s}$)

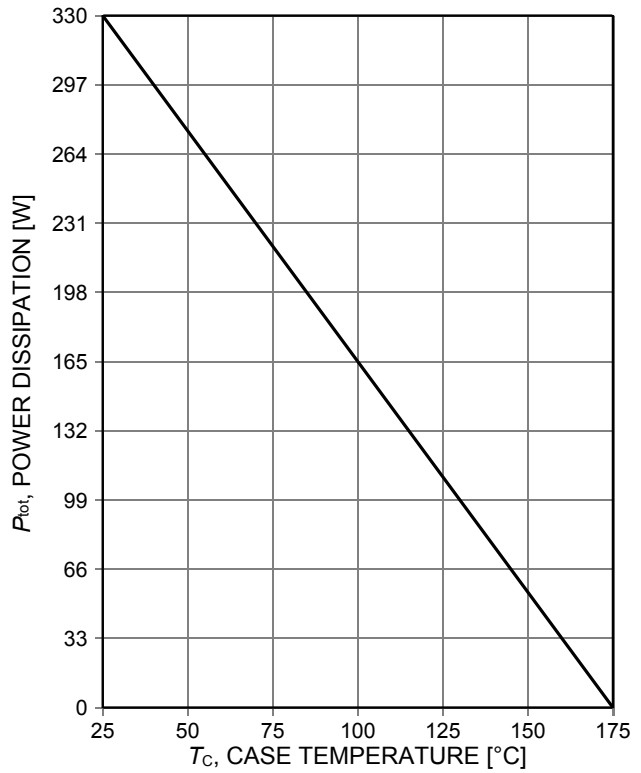

Figure 2. **Power dissipation as a function of case temperature**
 ($T_{vj}\leq 175^\circ\text{C}$)

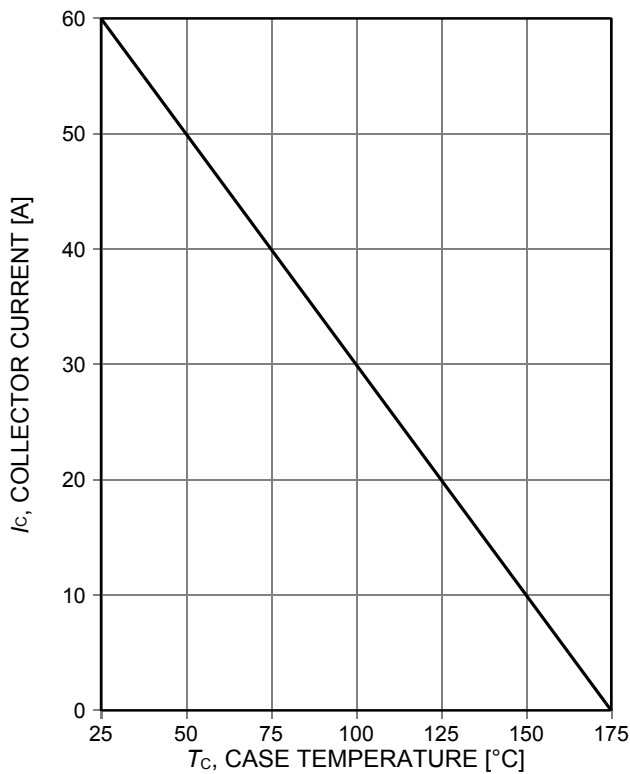

Figure 3. **Collector current as a function of case temperature**
 ($V_{GE}\geq 15\text{V}$, $T_{vj}\leq 175^\circ\text{C}$)

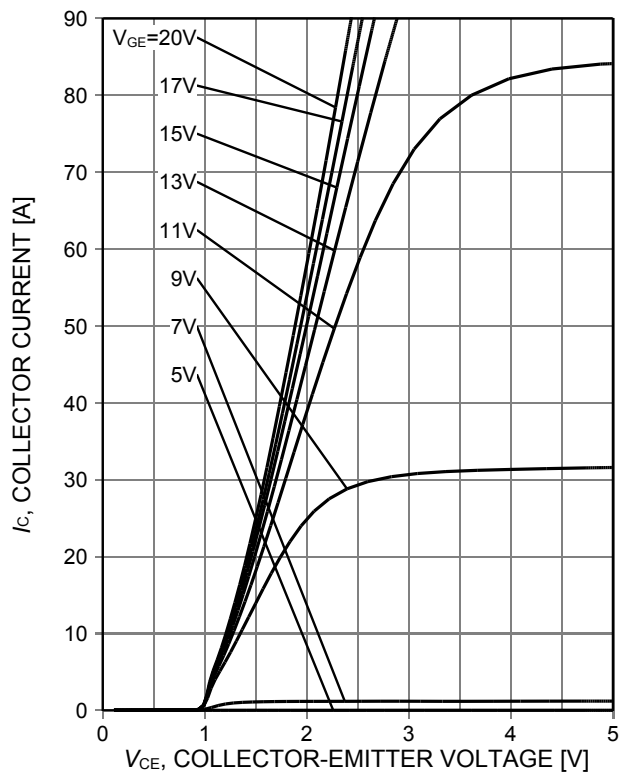

Figure 4. **Typical output characteristic**
 ($T_{vj}=25^\circ\text{C}$)

Resonant Switching Series

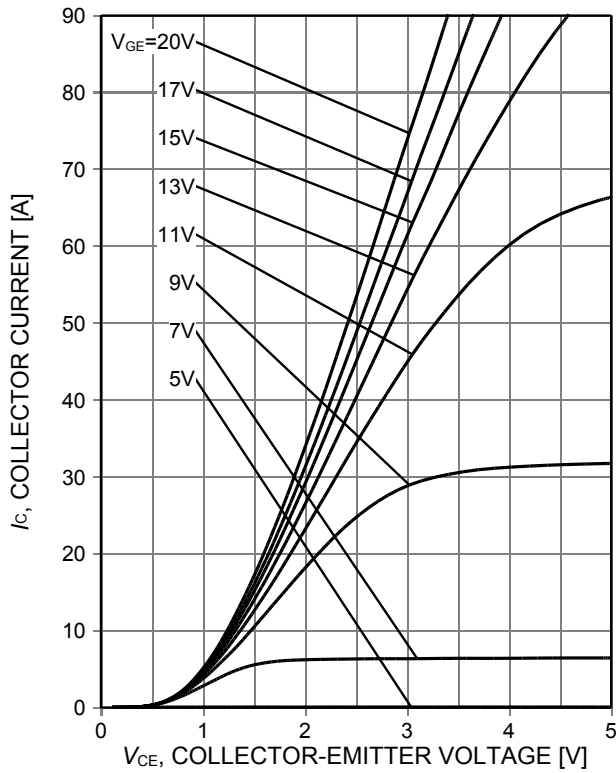

Figure 5. Typical output characteristic ($T_{vj}=175^\circ\text{C}$)

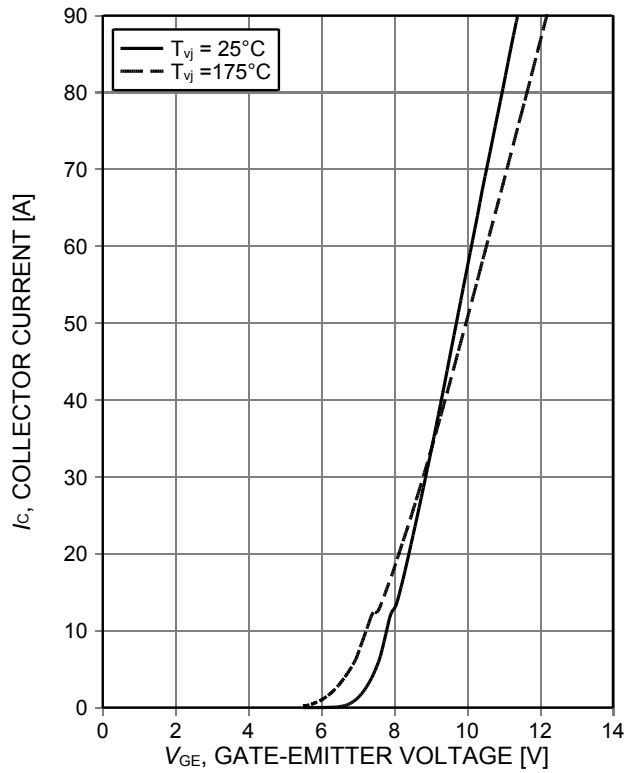

Figure 6. Typical transfer characteristic ($V_{CE}=20\text{V}$)

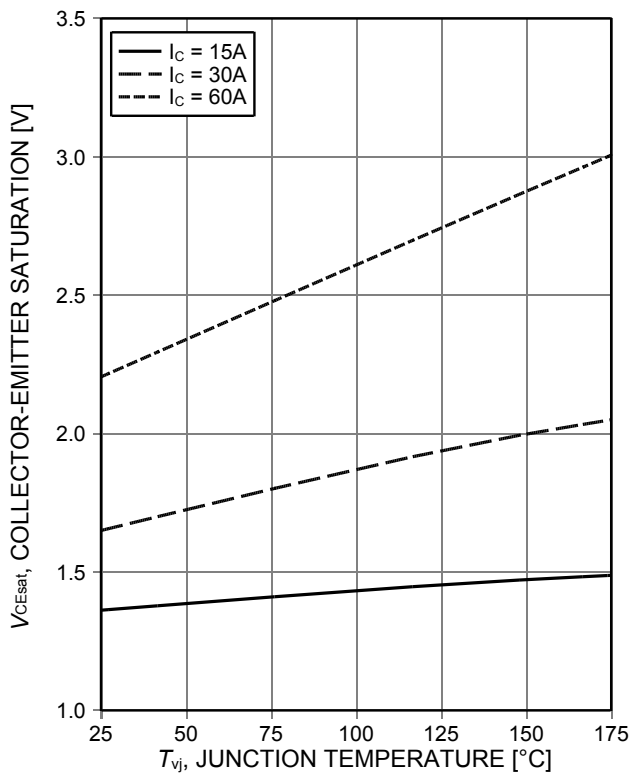

Figure 7. Typical collector-emitter saturation voltage as a function of junction temperature ($V_{GE}=15\text{V}$)

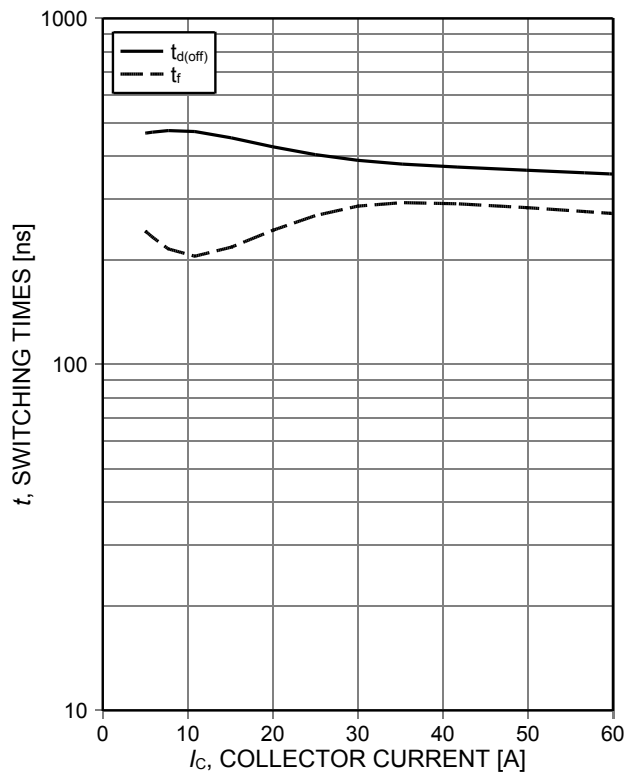

Figure 8. Typical switching times as a function of collector current (inductive load, $T_{vj}=175^\circ\text{C}$, $V_{CE}=600\text{V}$, $V_{GE}=0/15\text{V}$, $r_G=10\Omega$, Dynamic test circuit in Figure E)

Resonant Switching Series

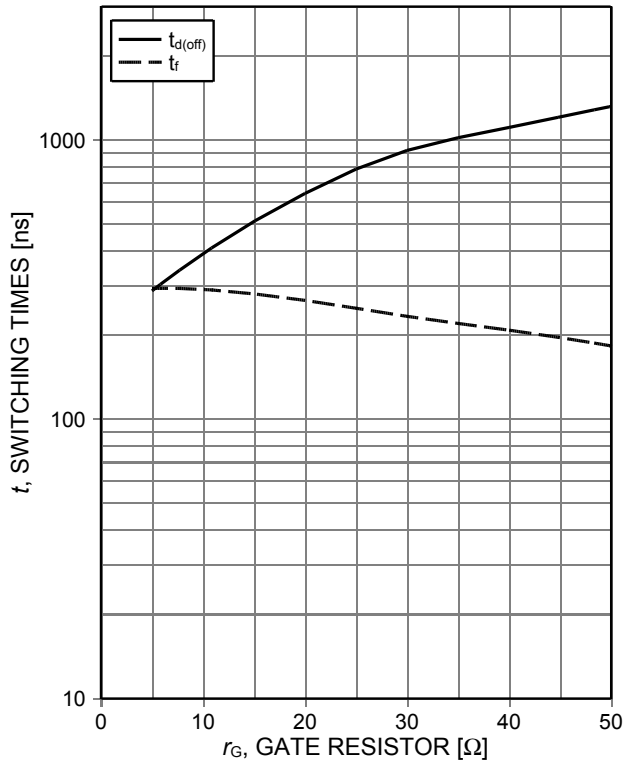

Figure 9. **Typical switching times as a function of gate resistor**
 (inductive load, $T_{vj}=175^\circ\text{C}$, $V_{CE}=600\text{V}$, $V_{GE}=0/15\text{V}$, $I_C=30\text{A}$, Dynamic test circuit in Figure E)

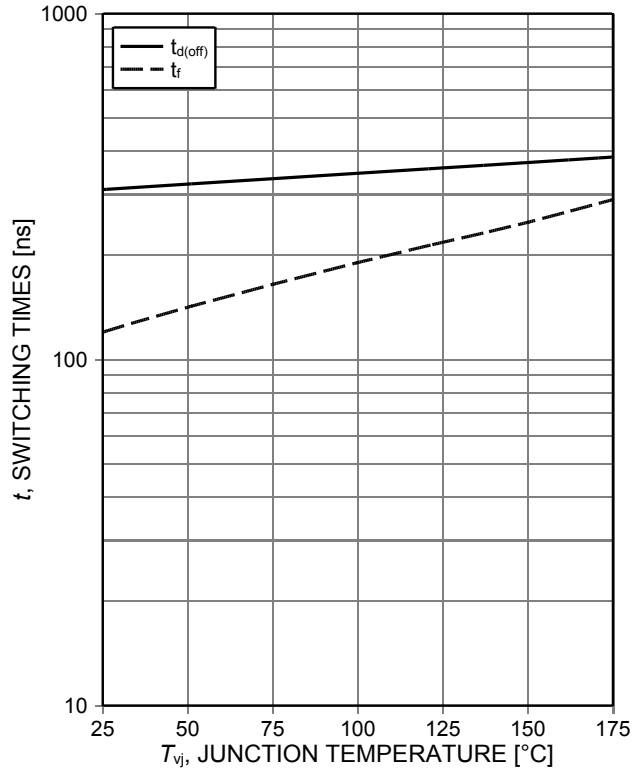

Figure 10. **Typical switching times as a function of junction temperature**
 (inductive load, $V_{CE}=600\text{V}$, $V_{GE}=0/15\text{V}$, $I_C=30\text{A}$, $r_G=10\Omega$, Dynamic test circuit in Figure E)

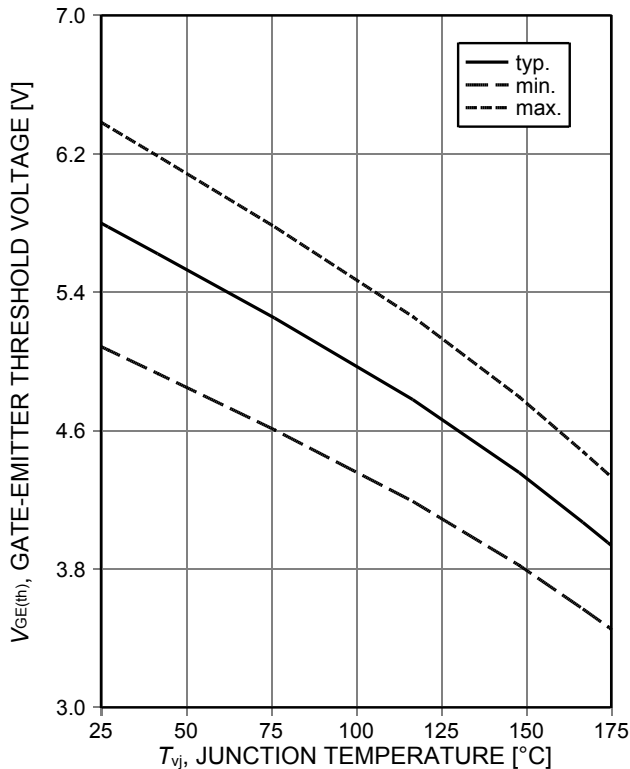

Figure 11. **Gate-emitter threshold voltage as a function of junction temperature**
 ($I_C=0.75\text{mA}$)

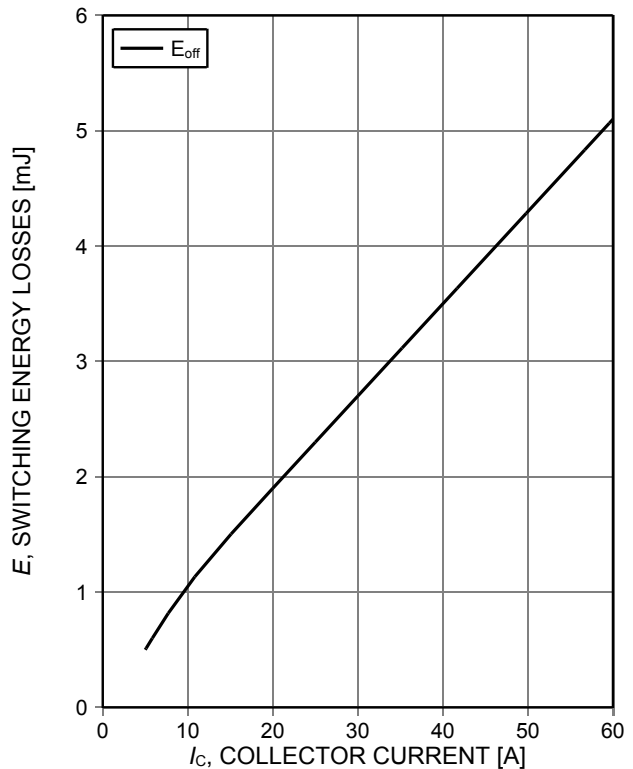

Figure 12. **Typical switching energy losses as a function of collector current**
 (inductive load, $T_{vj}=175^\circ\text{C}$, $V_{CE}=600\text{V}$, $V_{GE}=0/15\text{V}$, $r_G=10\Omega$, Dynamic test circuit in Figure E)

Resonant Switching Series

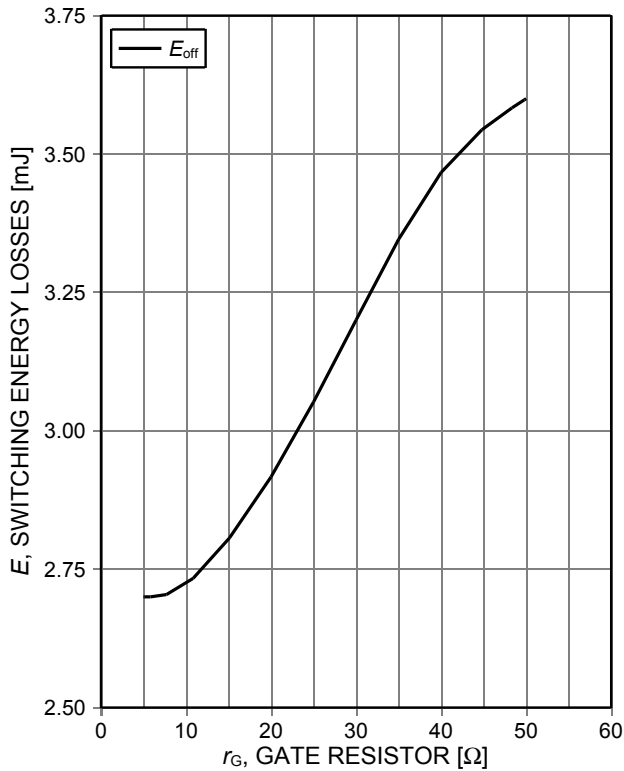

Figure 13. **Typical switching energy losses as a function of gate resistor**
 (inductive load, $T_{vj}=175^{\circ}\text{C}$, $V_{CE}=600\text{V}$, $V_{GE}=0/15\text{V}$, $I_C=30\text{A}$, Dynamic test circuit in Figure E)

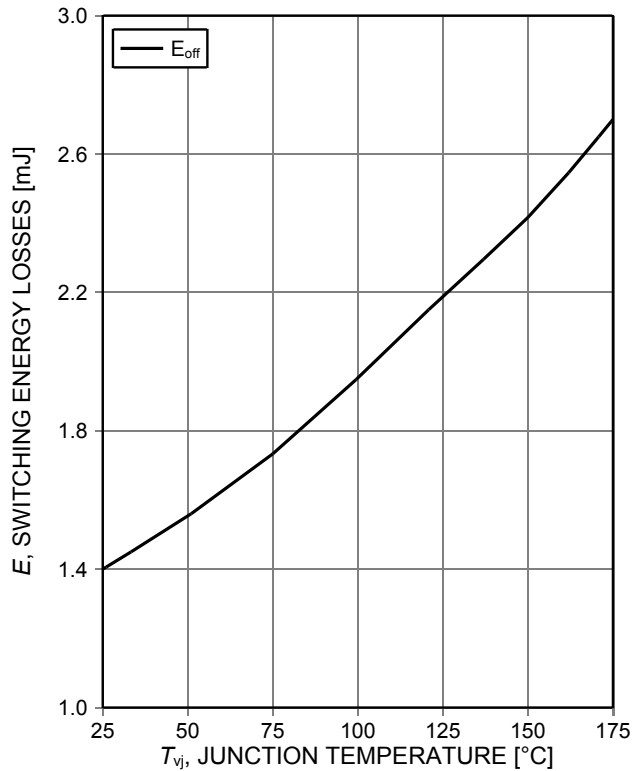

Figure 14. **Typical switching energy losses as a function of junction temperature**
 (inductive load, $V_{CE}=600\text{V}$, $V_{GE}=0/15\text{V}$, $I_C=30\text{A}$, $r_G=10\Omega$, Dynamic test circuit in Figure E)

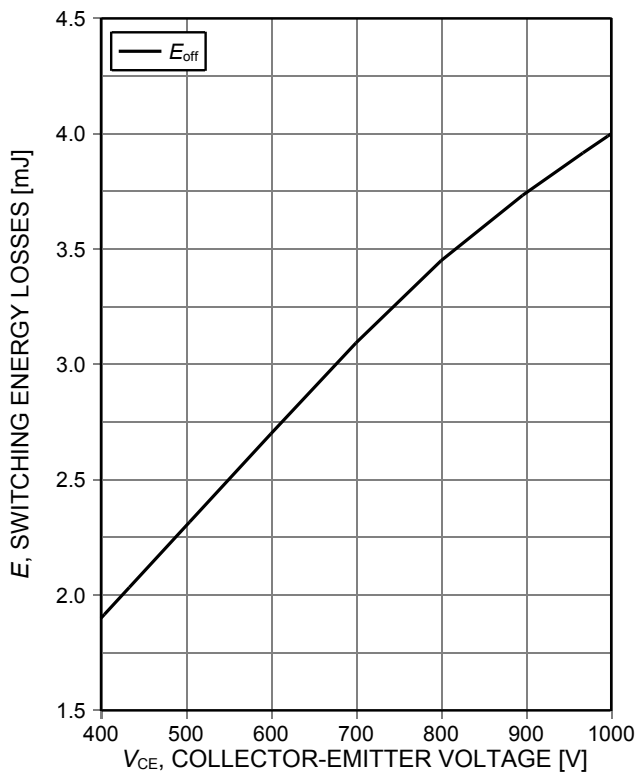

Figure 15. **Typical switching energy losses as a function of collector emitter voltage**
 (inductive load, $T_{vj}=175^{\circ}\text{C}$, $V_{GE}=0/15\text{V}$, $I_C=30\text{A}$, $r_G=10\Omega$, Dynamic test circuit in Figure E)

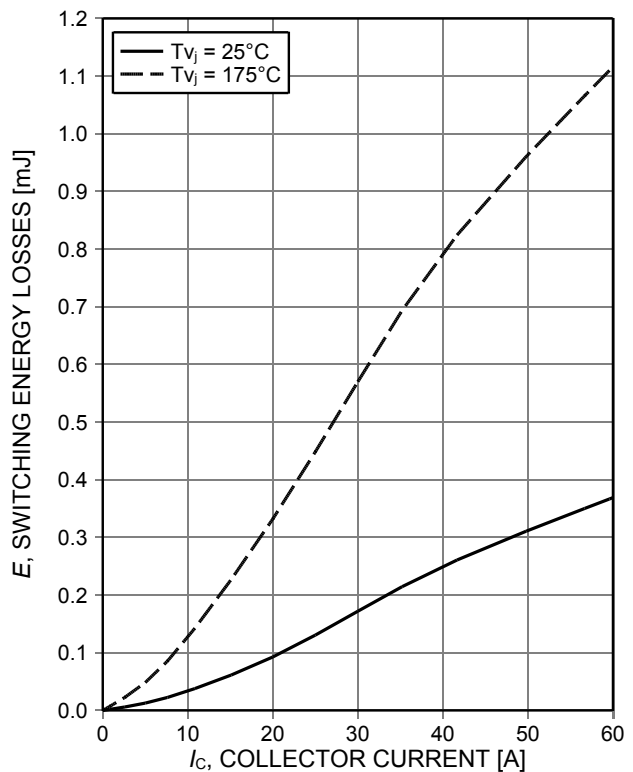

Figure 16. **Typical turn off switching energy loss for soft switching**
 (inductive load, $V_{CE}=600\text{V}$, $V_{GE}=0/15\text{V}$, $r_G=10\Omega$, Dynamic test circuit in Figure E)

Resonant Switching Series

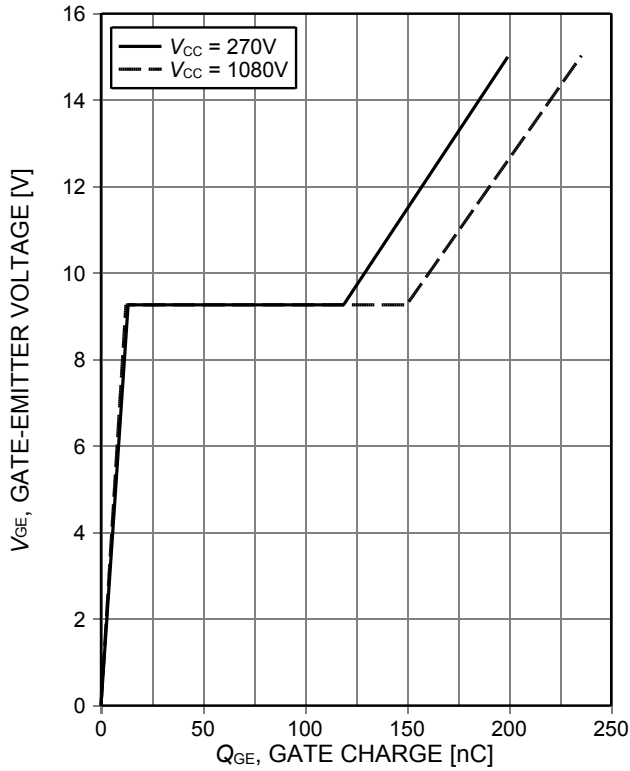

Figure 17. Typical gate charge ($I_C=30A$)

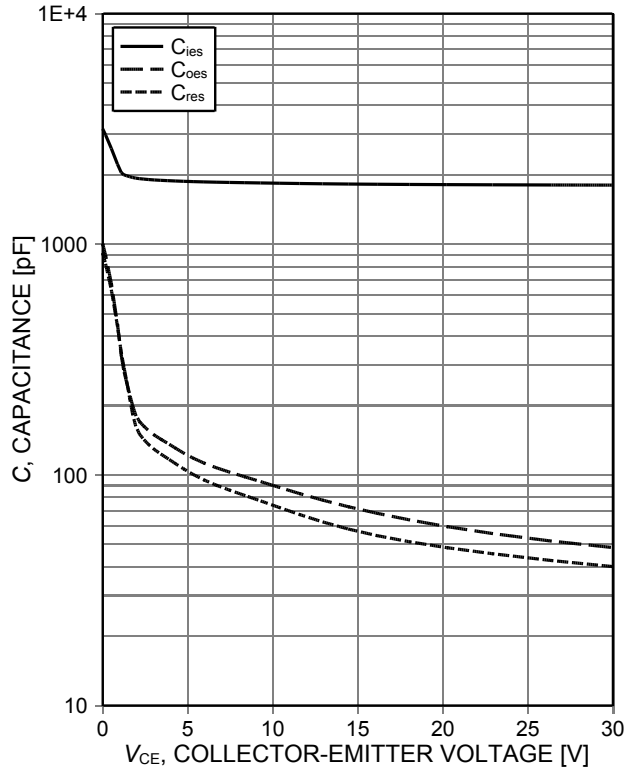

Figure 18. Typical capacitance as a function of collector-emitter voltage ($V_{GE}=0V$, $f=1MHz$)

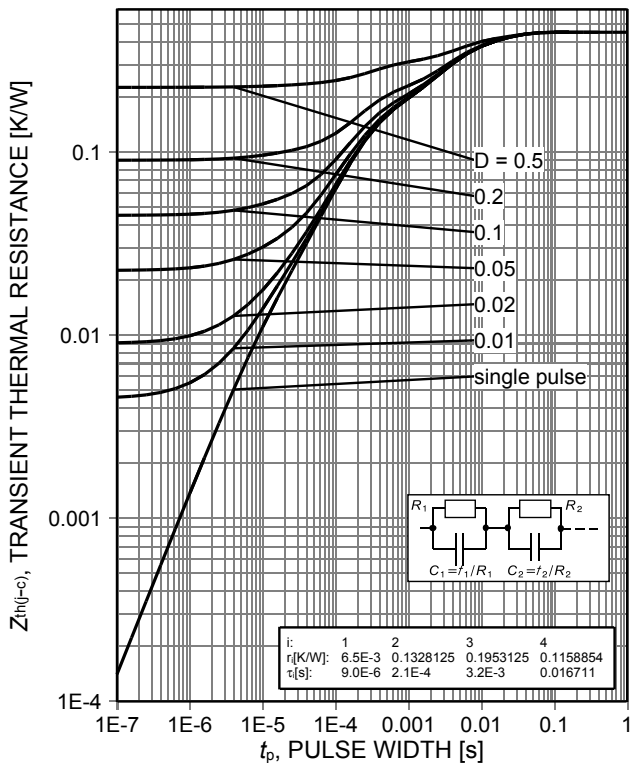

Figure 19. IGBT transient thermal resistance ($D=t_p/T$)

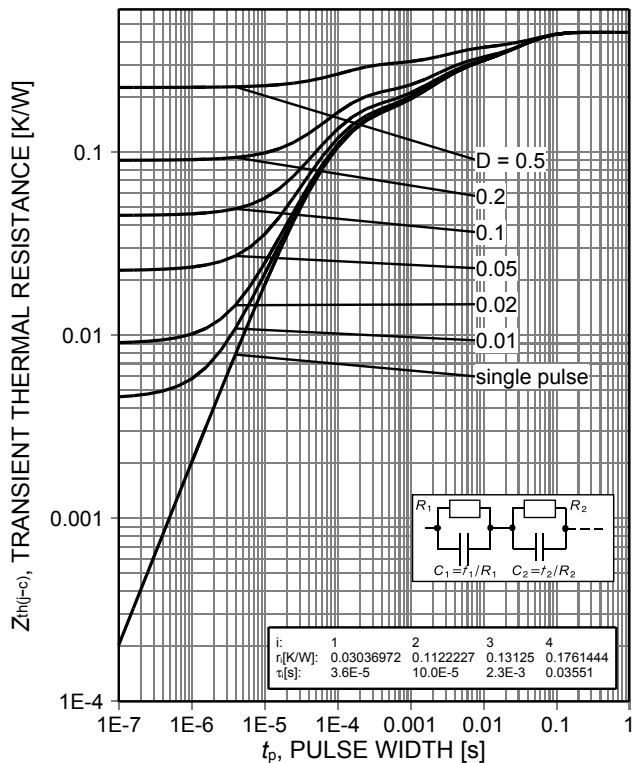

Figure 20. Diode transient thermal impedance as a function of pulse width ($D=t_p/T$)

Resonant Switching Series

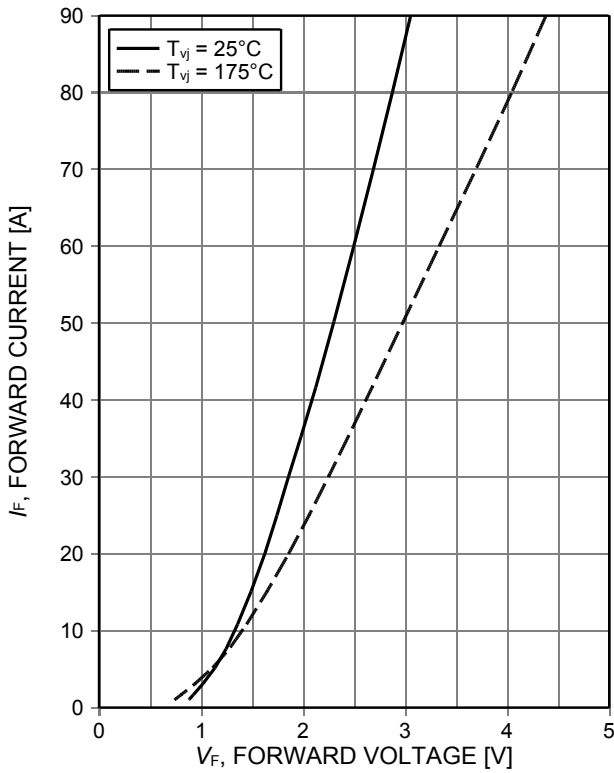

Figure 21. Typical diode forward current as a function of forward voltage

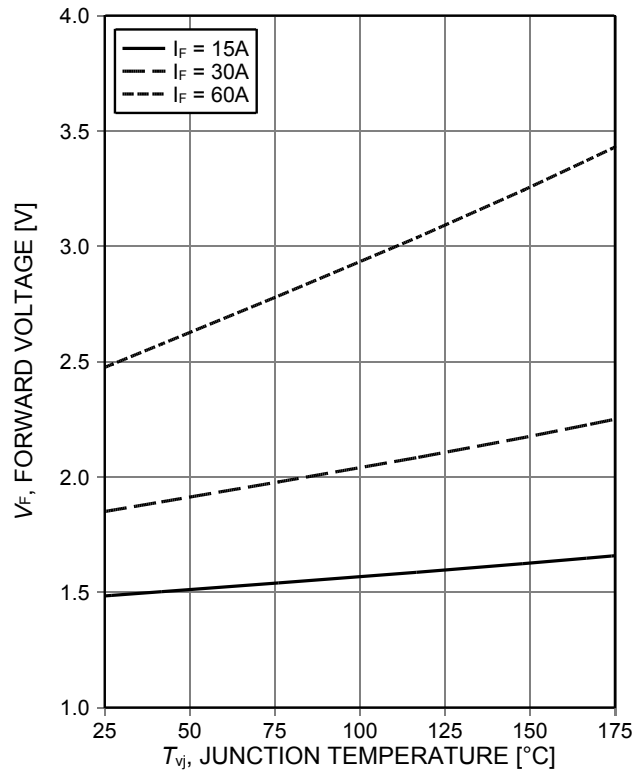
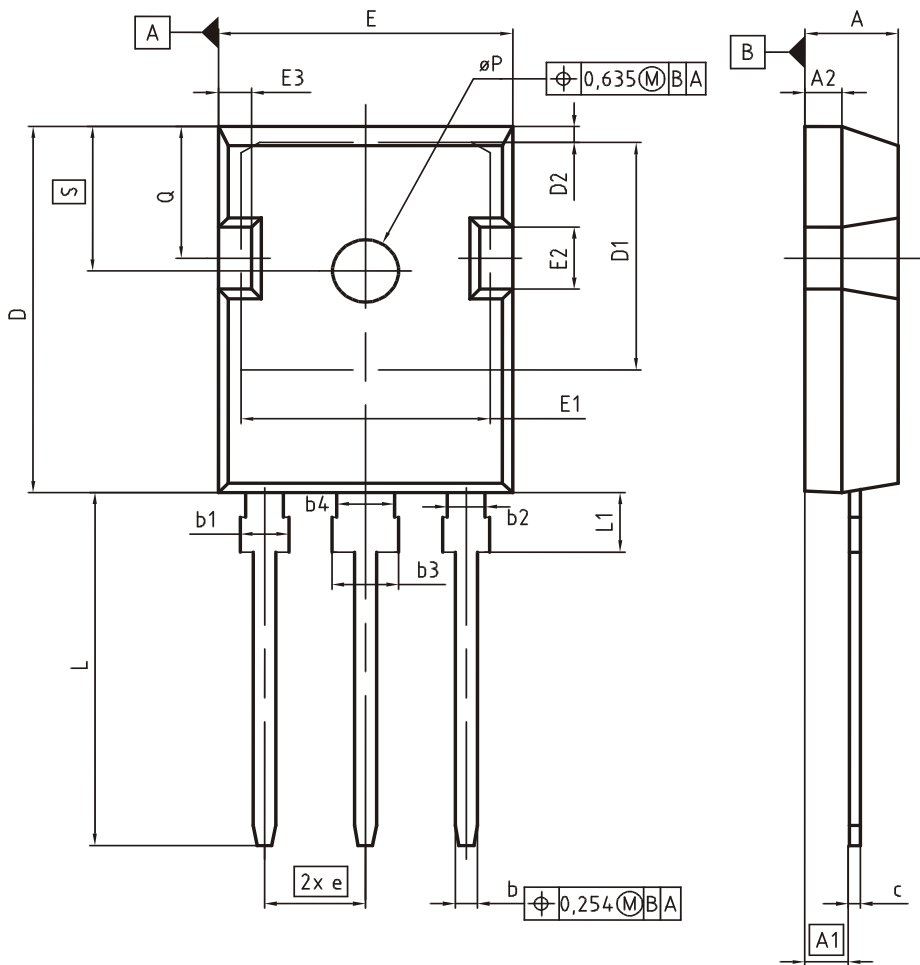

Figure 22. Typical diode forward voltage as a function of junction temperature

Package Drawing PG-TO247-3



DIM	MILLIMETERS		INCHES	
	MIN	MAX	MIN	MAX
A	4.83	5.21	0.190	0.205
A1	2.27	2.54	0.089	0.100
A2	1.85	2.16	0.073	0.085
b	1.07	1.33	0.042	0.052
b1	1.90	2.41	0.075	0.095
b2	1.90	2.16	0.075	0.085
b3	2.87	3.38	0.113	0.133
b4	2.87	3.13	0.113	0.123
c	0.55	0.68	0.022	0.027
D	20.80	21.10	0.819	0.831
D1	16.25	17.65	0.640	0.695
D2	0.95	1.35	0.037	0.053
E	15.70	16.13	0.618	0.635
E1	13.10	14.15	0.516	0.557
E2	3.68	5.10	0.145	0.201
E3	1.00	2.60	0.039	0.102
e	5.44 (BSC)		0.214 (BSC)	
N	3		3	
L	19.80	20.32	0.780	0.800
L1	4.10	4.47	0.161	0.176
ØP	3.50	3.70	0.138	0.146
Q	5.49	6.00	0.216	0.236
S	6.04	6.30	0.238	0.248

DOCUMENT NO.
Z8B00003327

SCALE

EUROPEAN PROJECTION

ISSUE DATE
09-07-2010

REVISION
05

Resonant Switching Series

Testing Conditions

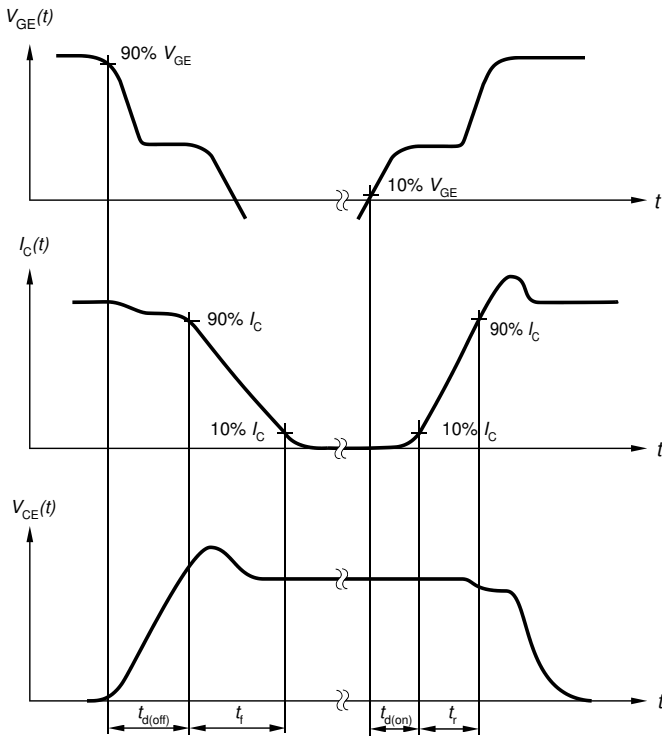

Figure A. Definition of switching times

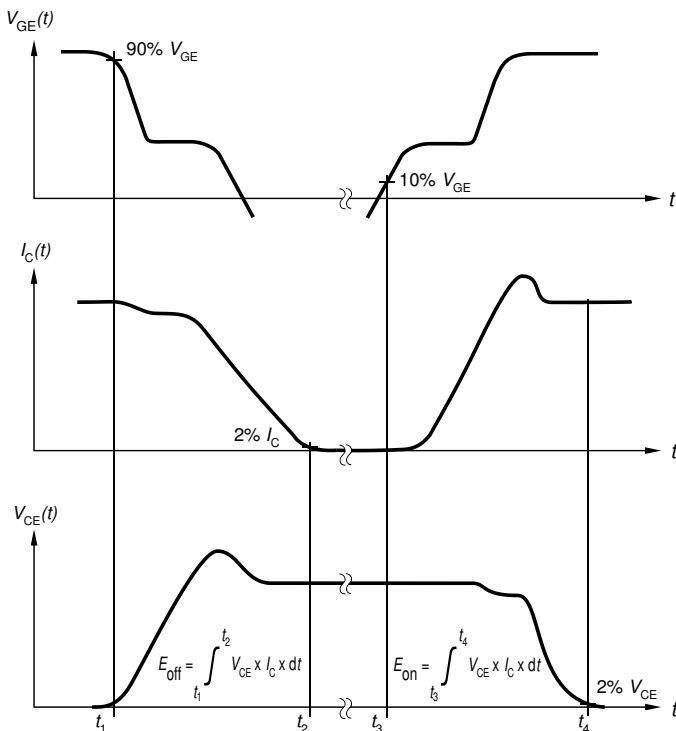

Figure B. Definition of switching losses

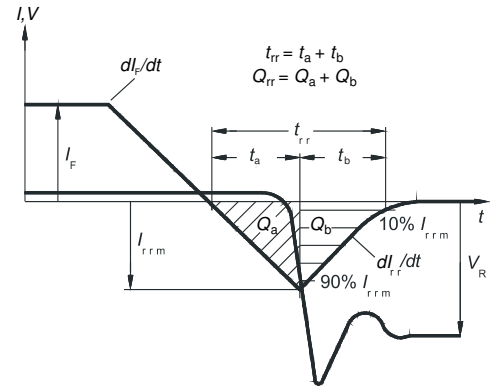

Figure C. Definition of diode switching characteristics

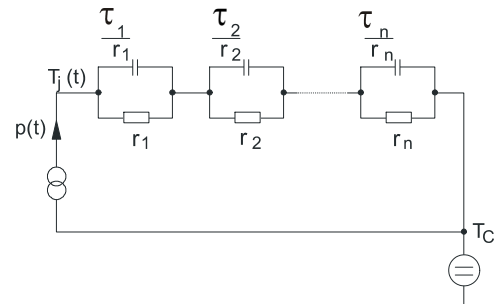

Figure D. Thermal equivalent circuit

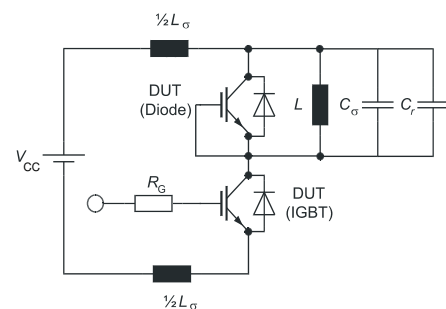

Figure E. Dynamic test circuit
Parasitic inductance L_{σ} ,
parasitic capacitor C_{σ} ,
relief capacitor C_r ,
(only for ZVT switching)

Resonant Switching Series**Revision History**

IHW30N135R5**Revision: 2019-09-20, Rev. 2.3**

Previous Revision

Revision	Date	Subjects (major changes since last revision)
2.1	2018-04-17	1
2.2	2018-09-19	Added thermal network on Fig.19 & 20
2.3	2019-09-20	additional parameter in maximum ratings table: non repetitive peak collector current

Trademarks

All referenced product or service names and trademarks are the property of their respective owners.

Published by
Infineon Technologies AG
81726 München, Germany
© Infineon Technologies AG 2019.
All Rights Reserved.

Important Notice

The information given in this document shall in no event be regarded as a guarantee of conditions or characteristics ("Beschaffenheitsgarantie"). With respect to any examples, hints or any typical values stated herein and/or any information regarding the application of the product, Infineon Technologies hereby disclaims any and all warranties and liabilities of any kind, including without limitation warranties of non-infringement of intellectual property rights of any third party.

In addition, any information given in this document is subject to customer's compliance with its obligations stated in this document and any applicable legal requirements, norms and standards concerning customer's products and any use of the product of Infineon Technologies in customer's applications.

The data contained in this document is exclusively intended for technically trained staff. It is the responsibility of customer's technical departments to evaluate the suitability of the product for the intended application and the completeness of the product information given in this document with respect to such application.

For further information on the product, technology, delivery terms and conditions and prices please contact your nearest Infineon Technologies office (www.infineon.com).

Please note that this product is not qualified according to the AEC Q100 or AEC Q101 documents of the Automotive Electronics Council.

Warnings

Due to technical requirements products may contain dangerous substances. For information on the types in question please contact your nearest Infineon Technologies office.

Except as otherwise explicitly approved by Infineon Technologies in a written document signed by authorized representatives of Infineon Technologies, Infineon Technologies' products may not be used in any applications where a failure of the product or any consequences of the use thereof can reasonably be expected to result in personal injury.

X-ON Electronics

Largest Supplier of Electrical and Electronic Components

Click to view similar products for [IGBT Transistors](#) category:

Click to view products by [Infineon](#) manufacturer:

Other Similar products are found below :

[IRG4PC30W](#) [APT20GT60BRDQ1G](#) [STGWA25H120DF2](#) [APT30GS60BRDQ2G](#) [TIG058E8-TL-H](#) [IDW40E65D2](#) [STGB40V60F](#)
[STGWA25H120F2](#) [NGTB75N65FL2WAG](#) [2MBI150VA-060-50](#) [NTE3320](#) [FGD3040G2-F085](#) [FGD3440G2-F085](#) [STGW80H65DFB-4](#)
[AFGY160T65SPD-B4](#) [IGW30N60TP](#) [IGW40N60TP](#) [IGW50N60TP](#) [IHW30N65R5](#) [IKFW40N60DH3E](#) [IKP15N65H5](#) [IKQ100N60T](#)
[IKQ120N60T](#) [IKW30N65WR5](#) [IKW75N60H3](#) [IKZ50N65NH5](#) [IKZ75N65NH5](#) [FGD3040G2-F085C](#) [FGH4L50T65SQD](#) [FGHL40T65MQDT](#)
[FGHL50T65MQD](#) [FGHL50T65MQDTL4](#) [FGHL75T65LQDT](#) [FGHL75T65MQD](#) [FGHL75T65MQDT](#) [FGHL75T65MQDTL4](#)
[FGY75T120SWD](#) [EL3120S1\(TA\)\(SAS\)-V](#) [IHW15N120E1](#) [IKQ75N120CS6](#) [IKW50N65WR5](#) [SL15T65FK](#) [KGF50N65KDF-U/H](#)
[IHF40N65R5S](#) [IKW08N120CS7XKSA1](#) [IKQ75N120CH3](#) [IHW30N160R5](#) [SGM100HF12A1TFD](#) [CRG50T60AK3SD](#) [CRG40T60AN3S](#)