

TRENCHSTOP™ IGBT6

IGBT in trench and field-stop technology with soft, fast recovery anti-parallel Rapid diode

Features and Benefits:

- Very low $V_{CE(sat)}$ 1.5V (typ.)
 - Maximum junction temperature 175°C
 - Short circuit withstand time 3μs
- Trench and field-stop technology for 650V applications offers :
- very tight parameter distribution
 - high ruggedness, temperature stable behavior
 - low V_{CEsat} and positive temperature coefficient
- Low gate charge Q_G
 - Pb-free lead plating; RoHS compliant
 - Very soft, fast recovery anti-parallel Rapid diode
 - Complete product spectrum and PSpice Models:
www.infineon.com/igbt

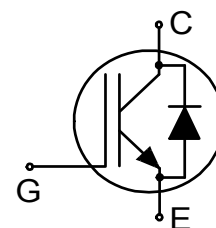

Potential Applications:

Drives

- GPD (general purpose drives)

Major home appliances

- Air conditioning
- Other major home appliances

Small home appliances

- Other small home appliances

Product Validation:

Qualified for industrial applications according to the relevant tests of JEDEC47/20/22



Key Performance and Package Parameters

Type	V_{CE}	I_C	$V_{CEsat}, T_{vj}=25^{\circ}C$	T_{vjmax}	Marking	Package
IKA08N65ET6	650V	8A	1.5V	175°C	K08EET6	PG-TO220-3 FP

Table of Contents

Description	1
Table of Contents	2
Maximum Ratings	3
Thermal Resistance	3
Electrical Characteristics	4
Electrical Characteristics Diagrams	6
Package Drawing	13
Testing Conditions	14
Revision History	15
Disclaimer	16

TRENCHSTOP™ IGBT6

Maximum Ratings

For optimum lifetime and reliability, Infineon recommends operating conditions that do not exceed 80% of the maximum ratings stated in this datasheet.

Parameter	Symbol	Value	Unit
Collector-emitter voltage, $T_{vj} \geq 25^{\circ}\text{C}$	V_{CE}	650	V
DC collector current, limited by $T_{vjmax}^{1)}$ $T_c = 25^{\circ}\text{C}$ $T_c = 100^{\circ}\text{C}$	I_C	16.0 10.0	A
Pulsed collector current, t_p limited by T_{vjmax}	I_{Cpuls}	25.0	A
Turn off safe operating area $V_{CE} \leq 650\text{V}$, $T_{vj} \leq 175^{\circ}\text{C}$	-	25.0	A
Diode forward current, limited by $T_{vjmax}^{1)}$ $T_c = 25^{\circ}\text{C}$ $T_c = 100^{\circ}\text{C}$	I_F	19.5 11.0	A
Diode pulsed current, t_p limited by T_{vjmax}	I_{Fpuls}	25.0	A
Gate-emitter voltage Transient Gate-emitter voltage ($t_p \leq 10\mu\text{s}$, $D < 0.010$)	V_{GE}	± 20 ± 30	V
Short circuit withstand time $V_{GE} = 15.0\text{V}$, $V_{CC} \leq 360\text{V}$ Allowed number of short circuits < 1000 Time between short circuits: $\geq 1.0\text{s}$ $T_{vj} = 150^{\circ}\text{C}$	t_{SC}	3	μs
Power dissipation $T_c = 25^{\circ}\text{C}$ Power dissipation $T_c = 100^{\circ}\text{C}$	P_{tot}	27.5 13.7	W
Operating junction temperature	T_{vj}	-40...+175	$^{\circ}\text{C}$
Storage temperature	T_{stg}	-55...+150	$^{\circ}\text{C}$
Soldering temperature, wave soldering 1.6mm (0.063in.) from case for 10s		260	$^{\circ}\text{C}$
Mounting torque, M2.5 screw Maximum of mounting processes: 3	M	0.5	Nm
Isolation voltage RMS, $f = 50/60\text{Hz}$, $t = 1\text{min}$	V_{isol}	2500	V

Thermal Resistance

Parameter	Symbol	Conditions	Value			Unit
			min.	typ.	max.	

R_{th} Characteristics

IGBT thermal resistance, junction - case	$R_{th(j-c)}$		-	-	5.46	K/W
Diode thermal resistance, junction - case	$R_{th(j-c)}$		-	-	6.41	K/W
Thermal resistance junction - ambient	$R_{th(j-a)}$		-	-	65	K/W

¹⁾ Limited by maximum junction temperature. Applicable for TO220 standard package.

TRENCHSTOP™ IGBT6

Electrical Characteristic, at $T_{vj} = 25^{\circ}\text{C}$, unless otherwise specified

Parameter	Symbol	Conditions	Value			Unit
			min.	typ.	max.	
Static Characteristic						
Collector-emitter breakdown voltage ¹⁾	$V_{(BR)CES}$	$V_{GE} = 0\text{V}, I_C = 0.10\text{mA}$	650	-	-	V
Collector-emitter saturation voltage	V_{CESat}	$V_{GE} = 15.0\text{V}, I_C = 5.0\text{A}$ $T_{vj} = 25^{\circ}\text{C}$ $T_{vj} = 125^{\circ}\text{C}$ $T_{vj} = 150^{\circ}\text{C}$	- - -	1.50 1.65 1.75	1.90 - -	V
Diode forward voltage	V_F	$V_{GE} = 0\text{V}, I_F = 5.0\text{A}$ $T_{vj} = 25^{\circ}\text{C}$ $T_{vj} = 125^{\circ}\text{C}$ $T_{vj} = 150^{\circ}\text{C}$	- - -	1.28 1.21 1.15	1.75 - -	V
Gate-emitter threshold voltage	$V_{GE(th)}$	$I_C = 0.12\text{mA}, V_{CE} = V_{GE}$	4.8	5.6	6.4	V
Zero gate voltage collector current	I_{CES}	$V_{CE} = 650\text{V}, V_{GE} = 0\text{V}$ $T_{vj} = 25^{\circ}\text{C}$ $T_{vj} = 150^{\circ}\text{C}$	- -	- 240	30 -	μA
Gate-emitter leakage current	I_{GES}	$V_{CE} = 0\text{V}, V_{GE} = 20\text{V}$	-	-	100	nA
Transconductance	g_{fs}	$V_{CE} = 20\text{V}, I_C = 5.0\text{A}$	-	5.5	-	S

Electrical Characteristic, at $T_{vj} = 25^{\circ}\text{C}$, unless otherwise specified

Parameter	Symbol	Conditions	Value			Unit
			min.	typ.	max.	
Dynamic Characteristic						
Input capacitance	C_{ies}	$V_{CE} = 25\text{V}, V_{GE} = 0\text{V}, f = 1\text{MHz}$	-	480	-	pF
Output capacitance	C_{oes}		-	29	-	
Reverse transfer capacitance	C_{res}		-	8	-	
Gate charge	Q_G	$V_{CC} = 520\text{V}, I_C = 5.0\text{A},$ $V_{GE} = 15\text{V}$	-	17.0	-	nC
Internal emitter inductance measured 5mm (0.197 in.) from case	L_E		-	7.0	-	nH
Short circuit collector current Max. 1000 short circuits Time between short circuits: $\geq 1.0\text{s}$	$I_{C(SC)}$	$V_{GE} = 15.0\text{V}, V_{CC} \leq 360\text{V},$ $t_{SC} \leq 3\mu\text{s}$ $T_{vj} = 150^{\circ}\text{C}$	-	50	-	A

¹⁾ Measured with filter network.

TRENCHSTOP™ IGBT6

Switching Characteristic, Inductive Load

Parameter	Symbol	Conditions	Value			Unit
			min.	typ.	max.	
IGBT Characteristic, at $T_{vj} = 25^{\circ}\text{C}$						
Turn-on delay time	$t_{d(on)}$	$T_{vj} = 25^{\circ}\text{C}$, $V_{CC} = 400\text{V}$, $I_C = 5.0\text{A}$, $V_{GE} = 0.0/15.0\text{V}$, $R_{G(on)} = 47.0\Omega$, $R_{G(off)} = 47.0\Omega$, $L_{\sigma} = 30\text{nH}$, $C_{\sigma} = 150\text{pF}$ L_{σ} , C_{σ} from Fig. E Energy losses include "tail" and diode reverse recovery.	-	20	-	ns
Rise time	t_r		-	12	-	ns
Turn-off delay time	$t_{d(off)}$		-	59	-	ns
Fall time	t_f		-	53	-	ns
Turn-on energy	E_{on}		-	0.11	-	mJ
Turn-off energy	E_{off}		-	0.04	-	mJ
Total switching energy	E_{ts}		-	0.15	-	mJ

Diode Characteristic, at $T_{vj} = 25^{\circ}\text{C}$

Diode reverse recovery time	t_{rr}	$T_{vj} = 25^{\circ}\text{C}$, $V_R = 400\text{V}$, $I_F = 5.0\text{A}$, $di_F/dt = 400\text{A}/\mu\text{s}$	-	43	-	ns
Diode reverse recovery charge	Q_{rr}		-	0.15	-	μC
Diode peak reverse recovery current	I_{rrm}		-	4.9	-	A
Diode peak rate of fall of reverse recovery current during t_b	di_{rr}/dt		-	-530	-	$\text{A}/\mu\text{s}$

Switching Characteristic, Inductive Load

Parameter	Symbol	Conditions	Value			Unit
			min.	typ.	max.	
IGBT Characteristic, at $T_{vj} = 150^{\circ}\text{C}$						
Turn-on delay time	$t_{d(on)}$	$T_{vj} = 150^{\circ}\text{C}$, $V_{CC} = 400\text{V}$, $I_C = 5.0\text{A}$, $V_{GE} = 0.0/15.0\text{V}$, $R_{G(on)} = 47.0\Omega$, $R_{G(off)} = 47.0\Omega$, $L_{\sigma} = 30\text{nH}$, $C_{\sigma} = 150\text{pF}$ L_{σ} , C_{σ} from Fig. E Energy losses include "tail" and diode reverse recovery.	-	18	-	ns
Rise time	t_r		-	12	-	ns
Turn-off delay time	$t_{d(off)}$		-	69	-	ns
Fall time	t_f		-	78	-	ns
Turn-on energy	E_{on}		-	0.14	-	mJ
Turn-off energy	E_{off}		-	0.07	-	mJ
Total switching energy	E_{ts}		-	0.21	-	mJ

Diode Characteristic, at $T_{vj} = 150^{\circ}\text{C}$

Diode reverse recovery time	t_{rr}	$T_{vj} = 150^{\circ}\text{C}$, $V_R = 400\text{V}$, $I_F = 5.0\text{A}$, $di_F/dt = 400\text{A}/\mu\text{s}$	-	65	-	ns
Diode reverse recovery charge	Q_{rr}		-	0.32	-	μC
Diode peak reverse recovery current	I_{rrm}		-	7.2	-	A
Diode peak rate of fall of reverse recovery current during t_b	di_{rr}/dt		-	-340	-	$\text{A}/\mu\text{s}$

TRENCHSTOP™ IGBT6

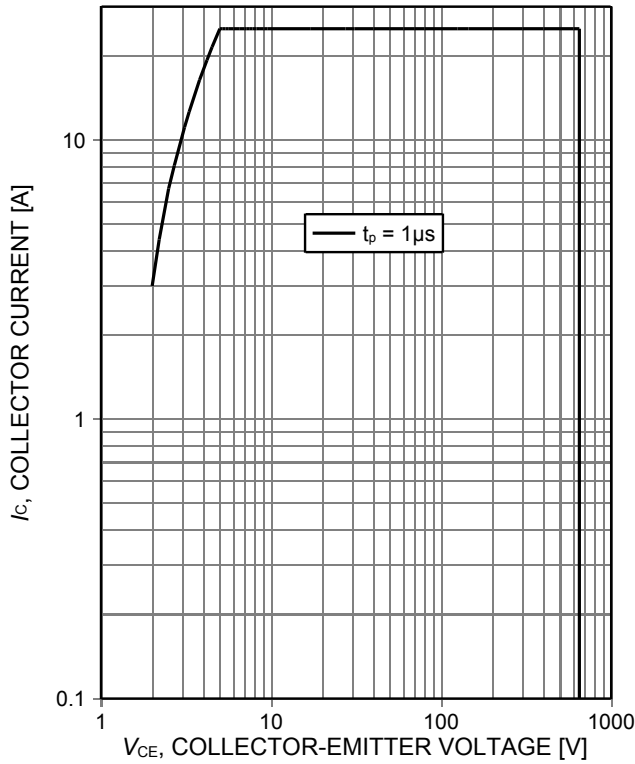

Figure 1. **Forward bias safe operating area**
 ($D=0$, $T_C=25^\circ\text{C}$, $T_{vj}\leq 175^\circ\text{C}$; $V_{GE}=15\text{V}$.
 Recommended use at $V_{GE}\geq 15\text{V}$)

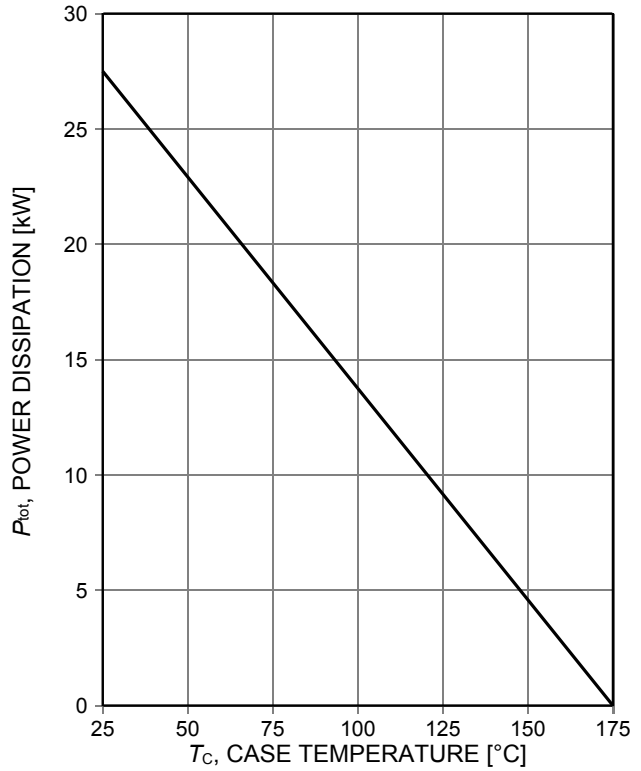

Figure 2. **Power dissipation as a function of case temperature**
 ($T_{vj}\leq 175^\circ\text{C}$)

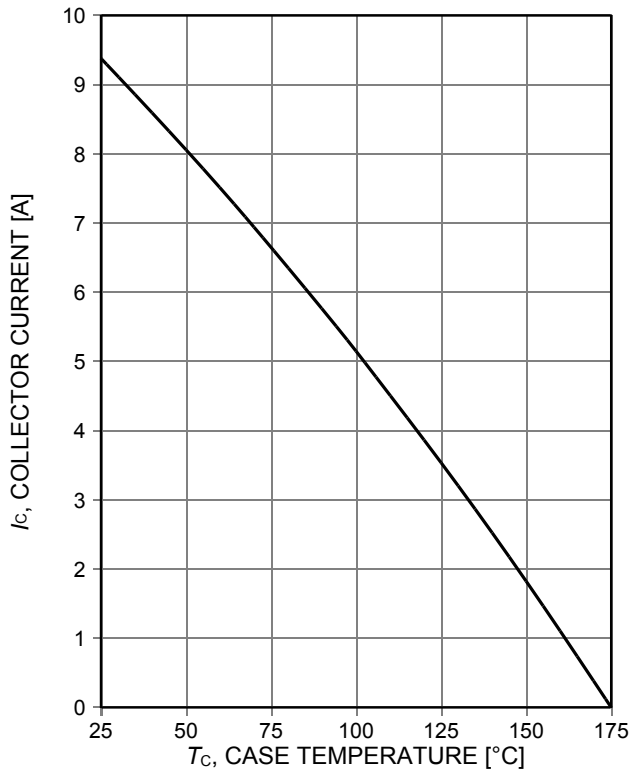

Figure 3. **Collector current as a function of case temperature**
 ($V_{GE}\geq 15\text{V}$, $T_{vj}\leq 175^\circ\text{C}$)

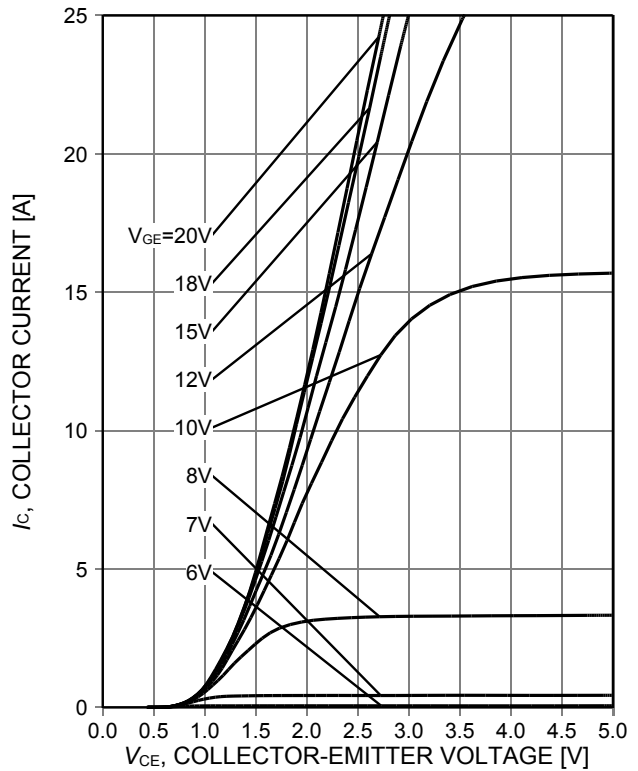

Figure 4. **Typical output characteristic**
 ($T_{vj}=25^\circ\text{C}$)

TRENCHSTOP™ IGBT6

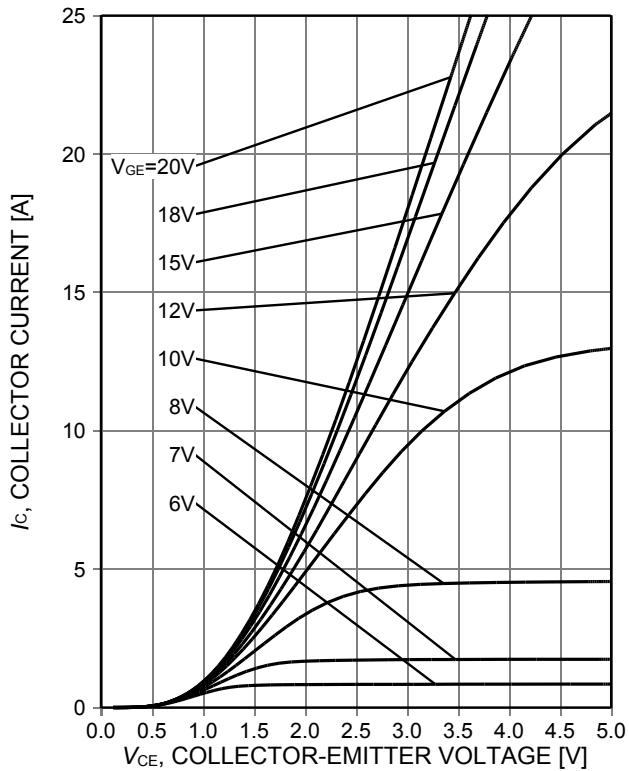

Figure 5. Typical output characteristic ($T_{vj}=150^{\circ}\text{C}$)

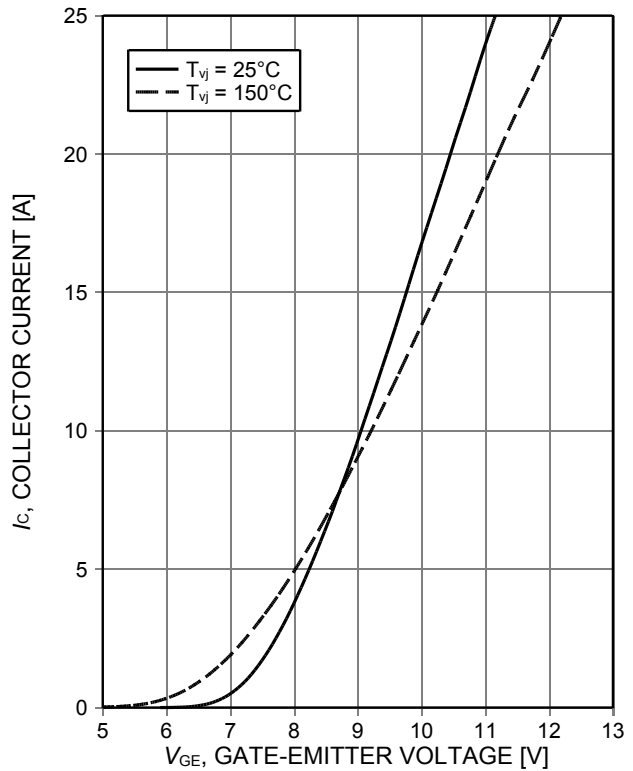

Figure 6. Typical transfer characteristic ($V_{CE}=50\text{V}$)

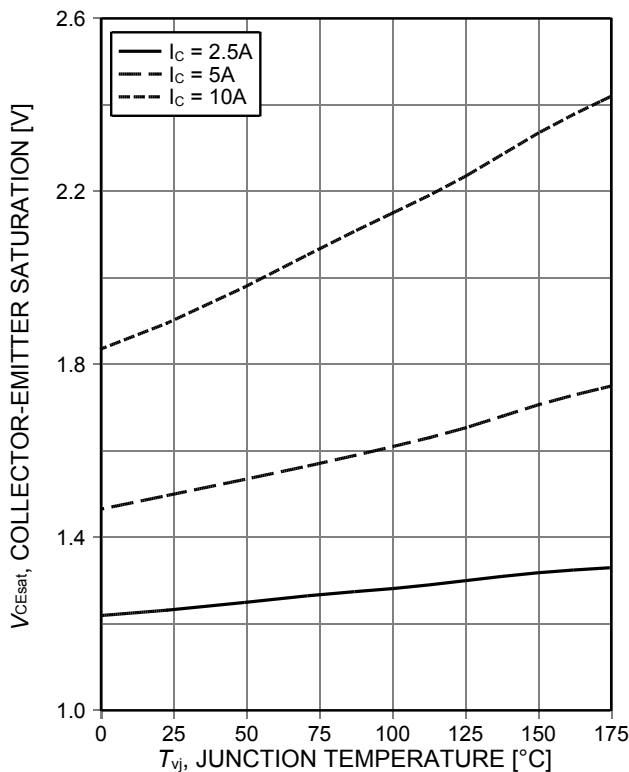

Figure 7. Typical collector-emitter saturation voltage as a function of junction temperature ($V_{GE}=15\text{V}$)

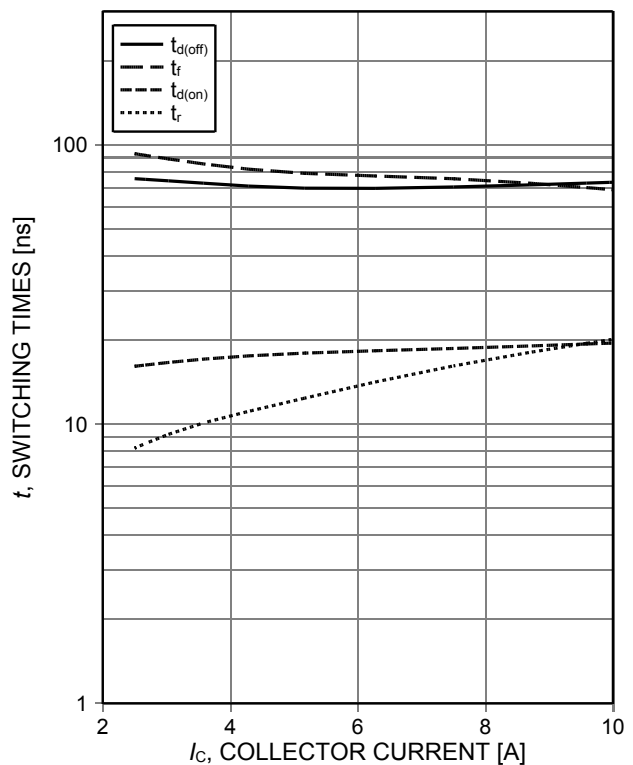

Figure 8. Typical switching times as a function of collector current (inductive load, $T_{vj}=150^{\circ}\text{C}$, $V_{CE}=400\text{V}$, $V_{GE}=15/0\text{V}$, $r_G=47\Omega$, Dynamic test circuit in Figure E)

TRENCHSTOP™ IGBT6

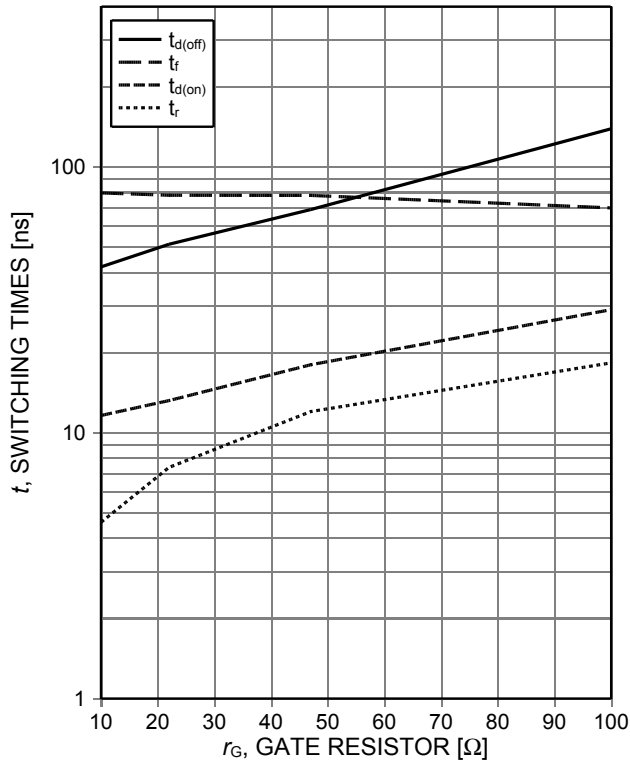

Figure 9. **Typical switching times as a function of gate resistor**
 (inductive load, $T_{vj}=150^{\circ}\text{C}$, $V_{CE}=400\text{V}$, $V_{GE}=15/0\text{V}$, $I_C=5\text{A}$, Dynamic test circuit in Figure E)

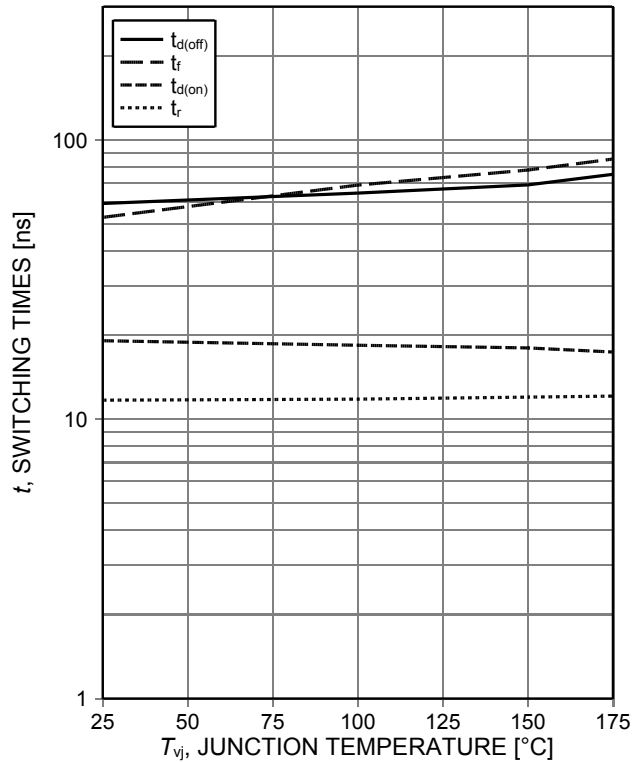

Figure 10. **Typical switching times as a function of junction temperature**
 (inductive load, $V_{CE}=400\text{V}$, $V_{GE}=15\text{V}$, $I_C=5\text{A}$, $r_G=47\Omega$, Dynamic test circuit in Figure E)

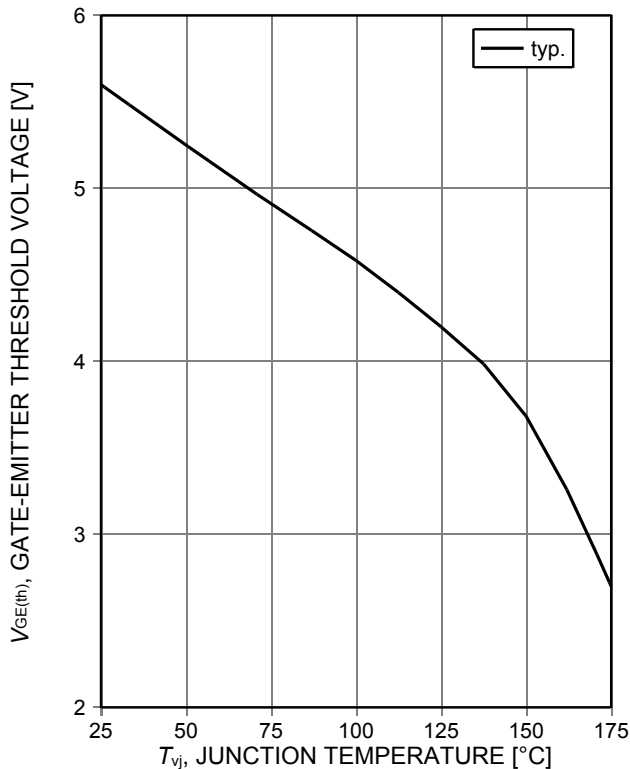

Figure 11. **Gate-emitter threshold voltage as a function of junction temperature**
 ($I_C=0.12\text{mA}$)

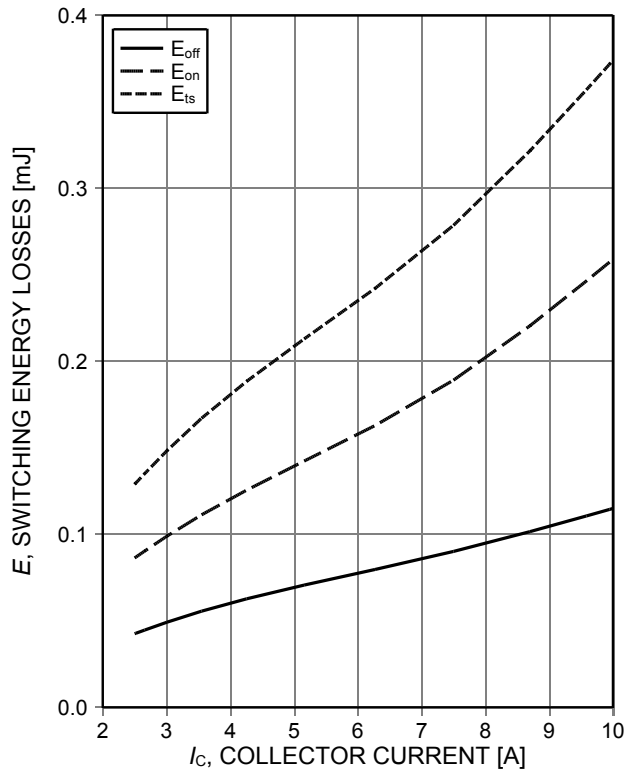

Figure 12. **Typical switching energy losses as a function of collector current**
 (inductive load, $T_{vj}=150^{\circ}\text{C}$, $V_{CE}=400\text{V}$, $V_{GE}=15/0\text{V}$, $r_G=47\Omega$, Dynamic test circuit in Figure E)

TRENCHSTOP™ IGBT6

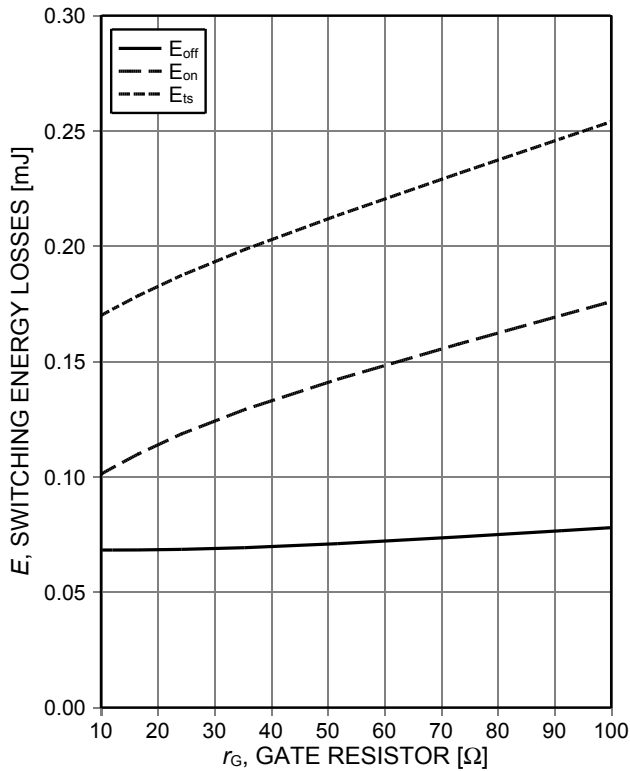

Figure 13. **Typical switching energy losses as a function of gate resistor**
 (inductive load, $T_{vj}=150^{\circ}\text{C}$, $V_{CE}=400\text{V}$, $V_{GE}=15/0\text{V}$, $I_C=5\text{A}$, Dynamic test circuit in Figure E)

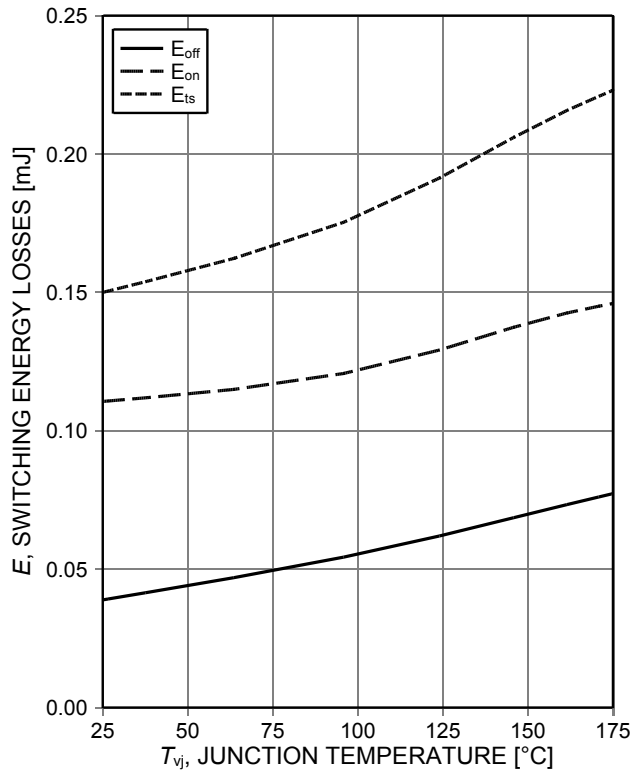

Figure 14. **Typical switching energy losses as a function of junction temperature**
 (inductive load, $V_{CE}=400\text{V}$, $V_{GE}=15\text{V}$, $I_C=5\text{A}$, $r_G=47\Omega$, Dynamic test circuit in Figure E)

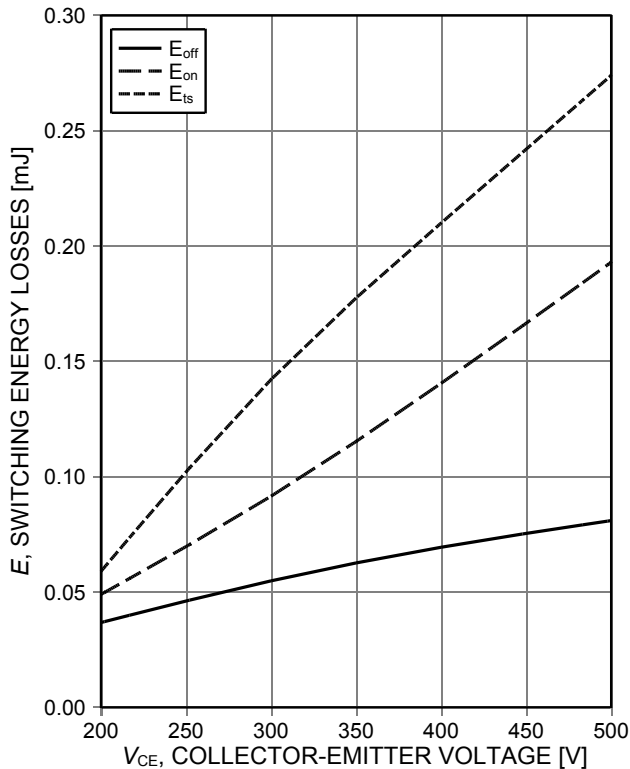

Figure 15. **Typical switching energy losses as a function of collector emitter voltage**
 (inductive load, $T_{vj}=150^{\circ}\text{C}$, $V_{GE}=15/0\text{V}$, $I_C=5\text{A}$, $r_G=47\Omega$, Dynamic test circuit in Figure E)

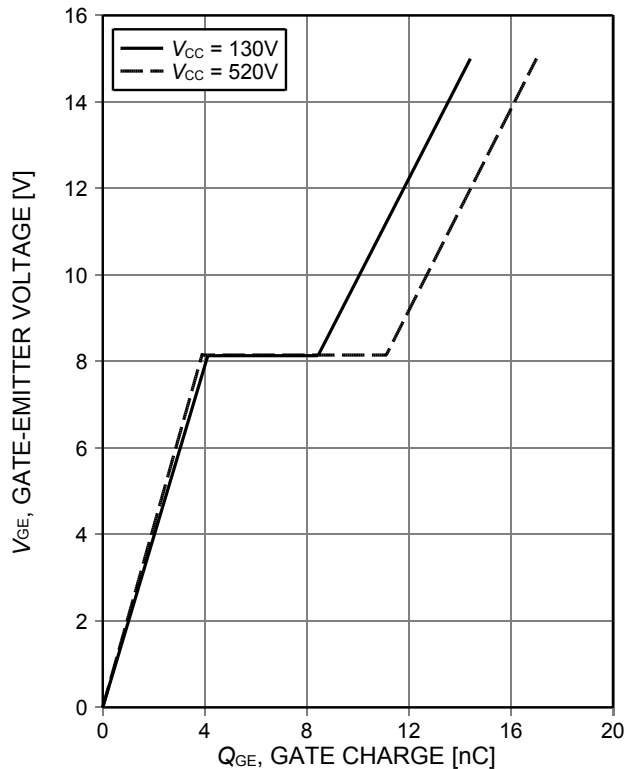

Figure 16. **Typical gate charge**
 ($I_C=5\text{A}$)

TRENCHSTOP™ IGBT6

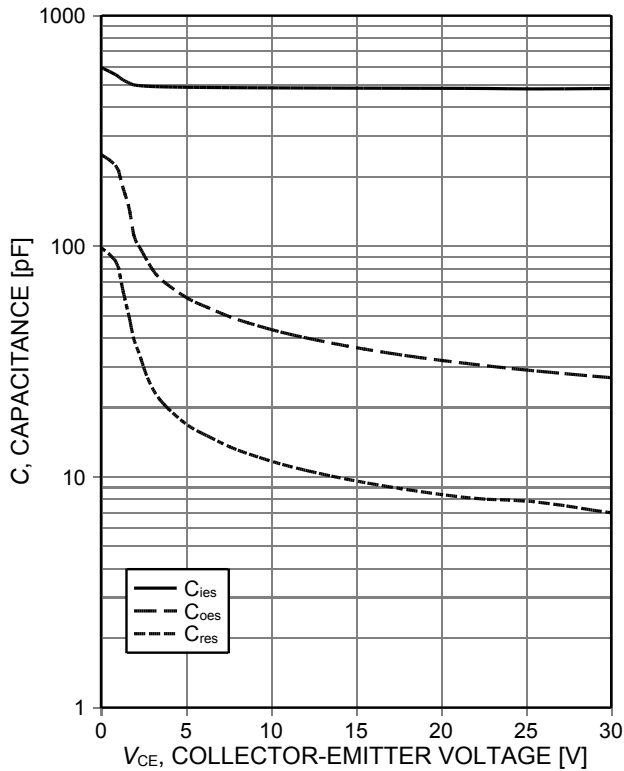

Figure 17. Typical capacitance as a function of collector-emitter voltage ($V_{GE}=0V, f=1MHz$)

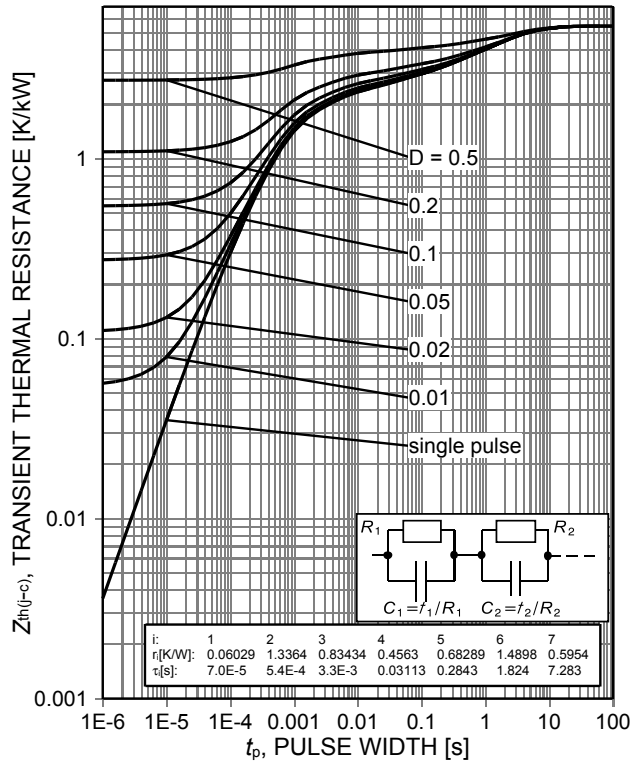

Figure 18. IGBT transient thermal impedance ($D=t_p/T$)

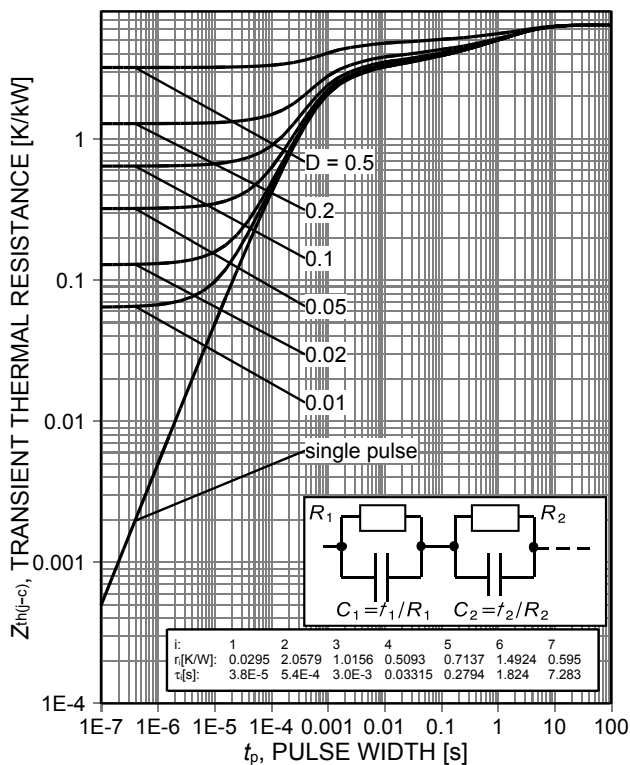

Figure 19. Diode transient thermal impedance as a function of pulse width ($D=t_p/T$)

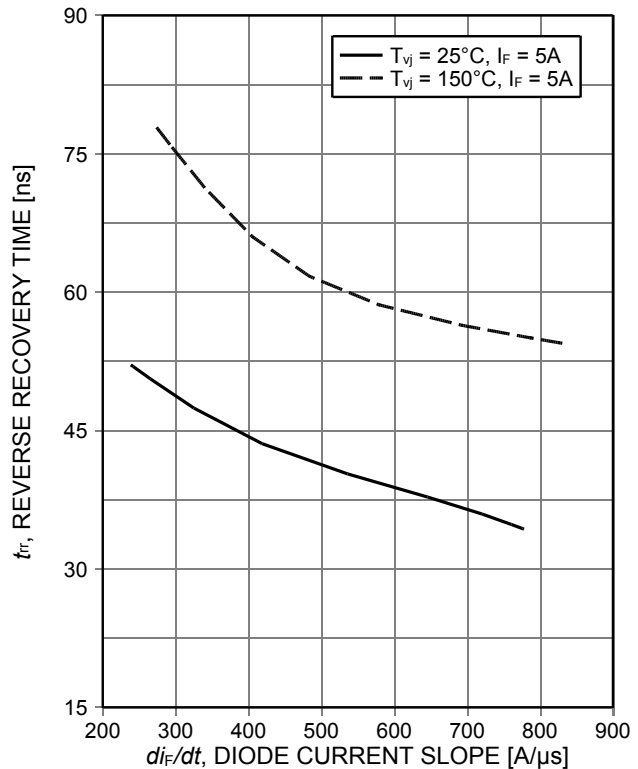

Figure 20. Typical reverse recovery time as a function of diode current slope ($V_R=400V$)

TRENCHSTOP™ IGBT6

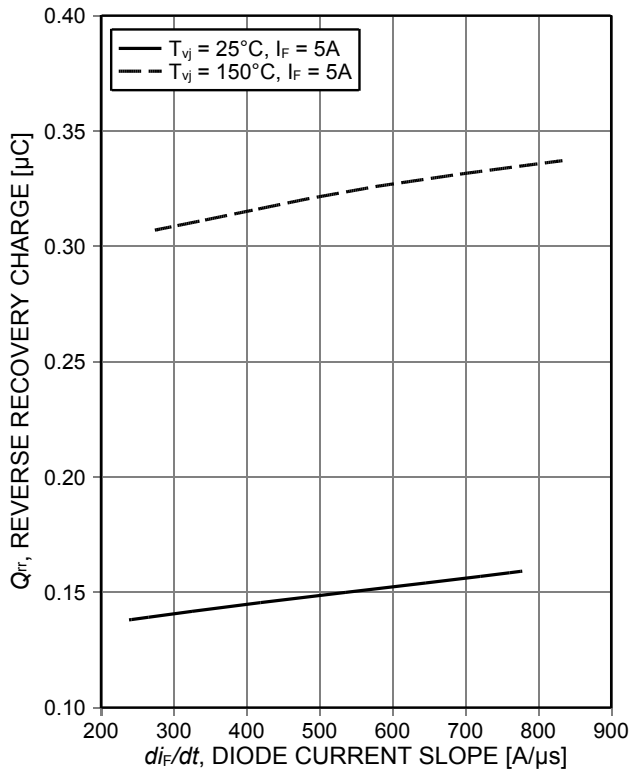

Figure 21. Typical reverse recovery charge as a function of diode current slope (VR=400V)

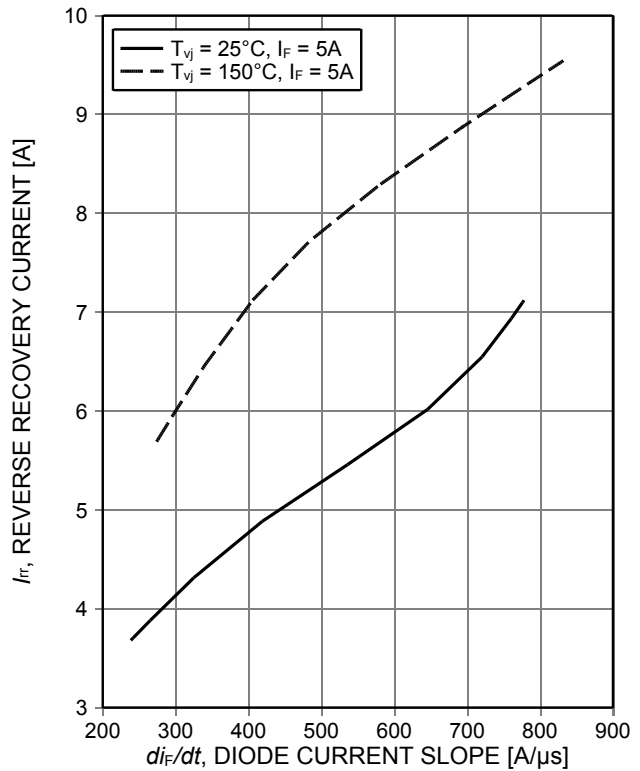

Figure 22. Typical reverse recovery current as a function of diode current slope (VR=400V)

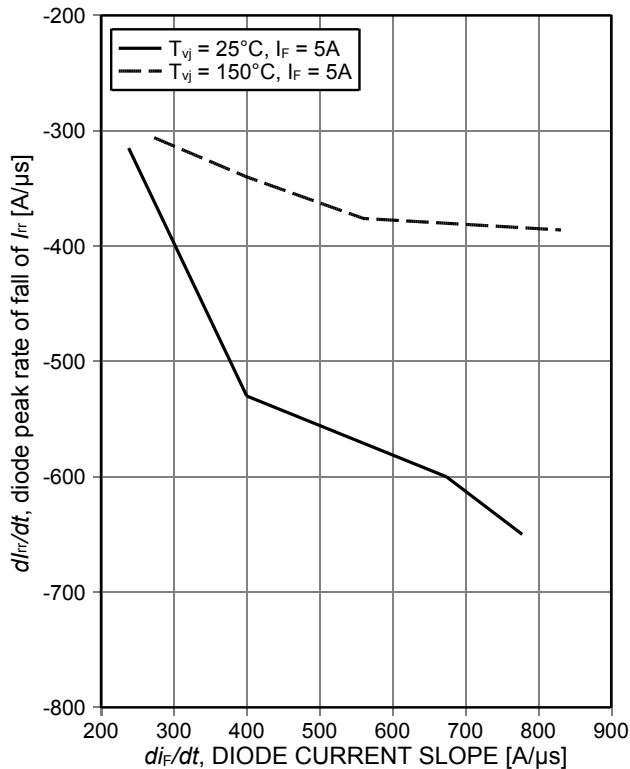

Figure 23. Typical diode peak rate of fall of reverse recovery current as a function of diode current slope (VR=400V)

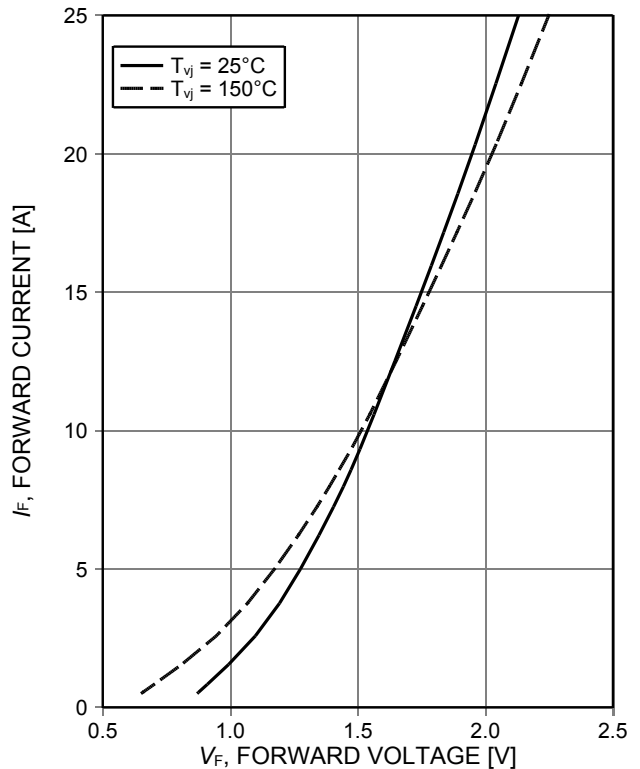

Figure 24. Typical diode forward current as a function of forward voltage

TRENCHSTOP™ IGBT6

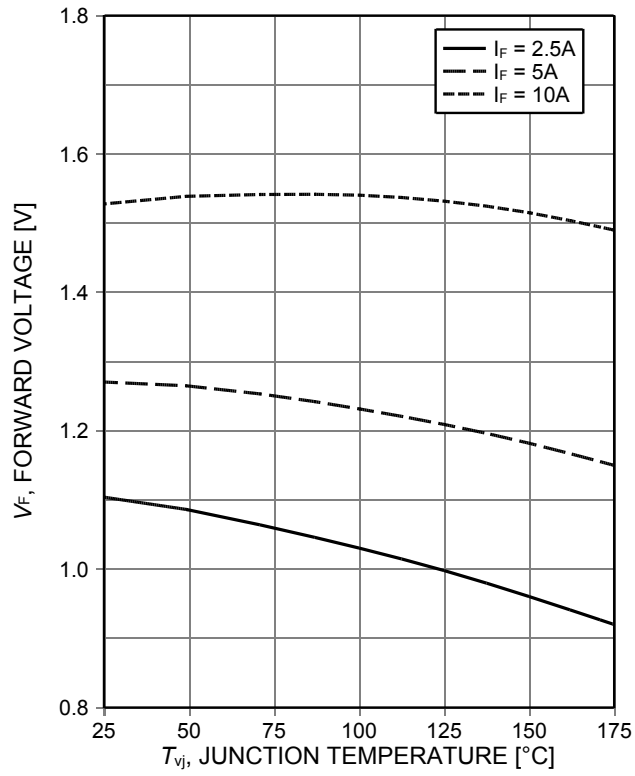
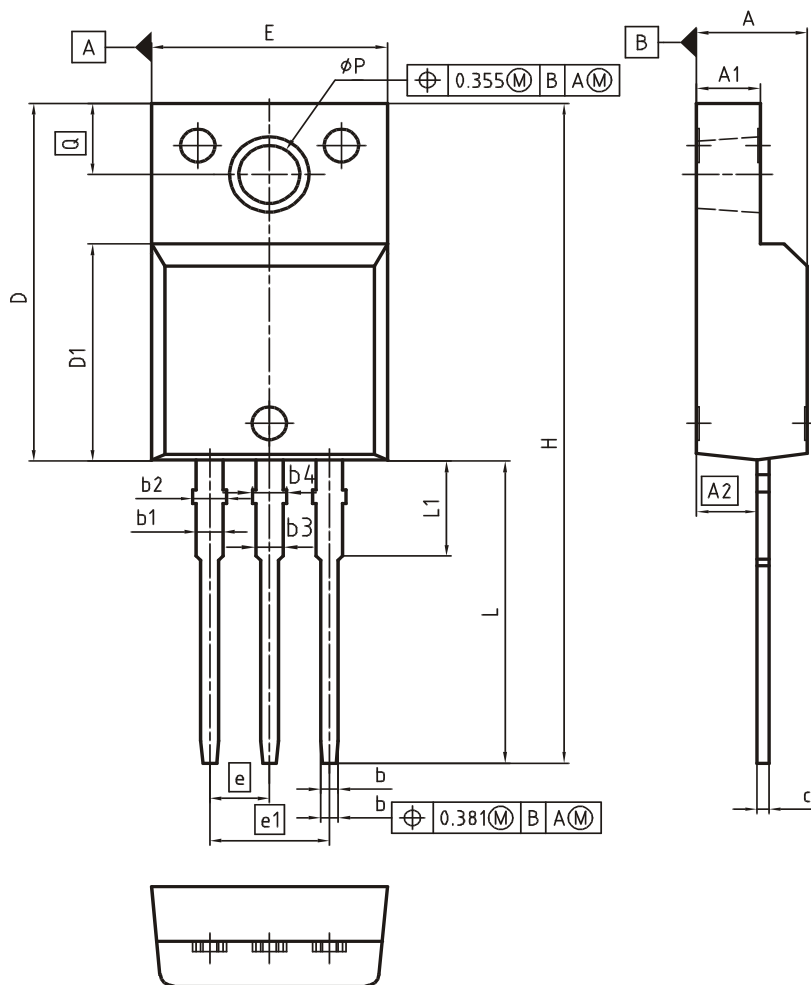

Figure 25. Typical diode forward voltage as a function of junction temperature

Package Drawing PG-TO220-3-FP



DIM	MILLIMETERS		INCHES	
	MIN	MAX	MIN	MAX
A	4.55	4.85	0.179	0.191
A1	2.55	2.85	0.100	0.112
A2	2.42	2.72	0.095	0.107
b	0.65	0.85	0.026	0.033
b1	0.95	1.33	0.037	0.052
b2	0.95	1.51	0.037	0.059
b3	0.65	1.33	0.026	0.052
b4	0.65	1.51	0.026	0.059
c	0.40	0.63	0.016	0.025
D	15.85	16.15	0.624	0.636
D1	9.53	9.83	0.375	0.387
E	10.35	10.65	0.407	0.419
e	2.54		0.100	
e1	5.08		0.200	
N	3		3	
H	29.45	29.75	1.159	1.171
L	13.45	13.75	0.530	0.541
L1	3.15	3.45	0.124	0.136
φP	2.95	3.20	0.116	0.126
Q	3.15	3.50	0.124	0.138

DOCUMENT NO.
Z8B00003319

SCALE

EUROPEAN PROJECTION

ISSUE DATE
08-03-2007

REVISION
03

TRENCHSTOP™ IGBT6

Testing Conditions



Figure A. Definition of switching times



Figure B. Definition of switching losses

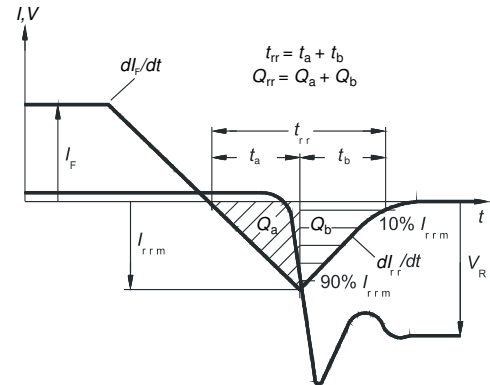

Figure C. Definition of diode switching characteristics

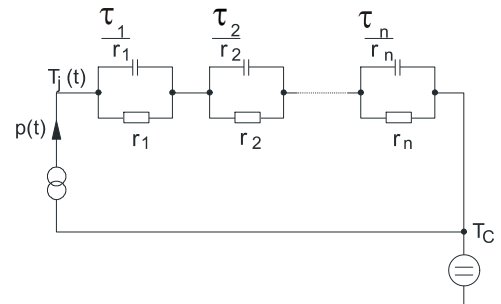

Figure D. Thermal equivalent circuit



Figure E. Dynamic test circuit
Parasitic inductance L_{σ} ,
parasitic capacitor C_{σ} ,
relief capacitor C_r ,
(only for ZVT switching)

TRENCHSTOP™ IGBT6**Revision History**

IKA08N65ET6**Revision: 2019-09-13, Rev. 2.3**

Previous Revision

Revision	Date	Subjects (major changes since last revision)
2.1	2017-09-11	Final Datasheet
2.2	2017-11-30	New Gfs Value at VCE=20V
2.3	2019-09-13	Change of Rth/Zth values and maximum DC ratings

Trademarks

All referenced product or service names and trademarks are the property of their respective owners.

Published by
Infineon Technologies AG
81726 München, Germany
© Infineon Technologies AG 2019.
All Rights Reserved.

Important Notice

The information given in this document shall in no event be regarded as a guarantee of conditions or characteristics ("Beschaffenheitsgarantie"). With respect to any examples, hints or any typical values stated herein and/or any information regarding the application of the product, Infineon Technologies hereby disclaims any and all warranties and liabilities of any kind, including without limitation warranties of non-infringement of intellectual property rights of any third party.

In addition, any information given in this document is subject to customer's compliance with its obligations stated in this document and any applicable legal requirements, norms and standards concerning customer's products and any use of the product of Infineon Technologies in customer's applications.

The data contained in this document is exclusively intended for technically trained staff. It is the responsibility of customer's technical departments to evaluate the suitability of the product for the intended application and the completeness of the product information given in this document with respect to such application.

For further information on the product, technology, delivery terms and conditions and prices please contact your nearest Infineon Technologies office (www.infineon.com).

Please note that this product is not qualified according to the AEC Q100 or AEC Q101 documents of the Automotive Electronics Council.

Warnings

Due to technical requirements products may contain dangerous substances. For information on the types in question please contact your nearest Infineon Technologies office.

Except as otherwise explicitly approved by Infineon Technologies in a written document signed by authorized representatives of Infineon Technologies, Infineon Technologies' products may not be used in any applications where a failure of the product or any consequences of the use thereof can reasonably be expected to result in personal injury.

X-ON Electronics

Largest Supplier of Electrical and Electronic Components

Click to view similar products for [IGBT Transistors](#) category:

Click to view products by [Infineon](#) manufacturer:

Other Similar products are found below :

[748152A](#) [APT20GT60BRDQ1G](#) [APT50GT60BRG](#) [NGTB10N60FG](#) [STGFW20V60DF](#) [APT30GP60BG](#) [APT45GR65B2DU30](#)
[GT50JR22\(STA1ES\)](#) [TIG058E8-TL-H](#) [IGW40N120H3FKSA1](#) [VS-CPV364M4KPBF](#) [NGTB25N120FL2WAG](#) [NGTG40N120FL2WG](#)
[RJH60F3DPQ-A0#T0](#) [APT40GR120B2SCD10](#) [APT15GT120BRG](#) [APT20GT60BRG](#) [NGTB75N65FL2WAG](#) [NGTG15N120FL2WG](#)
[IXA30RG1200DHGLB](#) [IXA40RG1200DHGLB](#) [APT70GR65B2DU40](#) [NTE3320](#) [QP12W05S-37A](#) [IHF40N65R5SXXSA1](#) [APT70GR120J](#)
[APT35GP120JDQ2](#) [XD15H120CX1](#) [XD25H120CX0](#) [XP15PJS120CL1B1](#) [IGW30N60H3FKSA1](#) [STGWA8M120DF3](#) [IGW08T120FKSA1](#)
[IGW75N60H3FKSA1](#) [FGH60N60SMD_F085](#) [FGH75T65UPD](#) [STGWA15H120F2](#) [IKA10N60TXKSA1](#) [IHW20N120R5XKSA1](#)
[RJH60D2DPP-M0#T2](#) [IKP20N60TXKSA1](#) [IHW20N65R5XKSA1](#) [APT70GR120JD60](#) [AOD5B60D](#) [APT70GR120L](#) [STGWT60H65FB](#)
[STGWT60H65DFB](#) [STGWT40V60DF](#) [STGWT20V60DF](#) [STGB10NB37LZT4](#)